

# ETSI TS 132 403 V6.9.0 (2005-09)

---

*Technical Specification*

**Digital cellular telecommunications system (Phase 2+);  
Universal Mobile Telecommunications System (UMTS);  
Telecommunication management;  
Performance Management (PM);  
Performance measurements - UMTS and combined UMTS/GSM  
(3GPP TS 32.403 version 6.9.0 Release 6)**

---



---

Reference

RTS/TSGS-0532403v690

---

Keywords

GSM, UMTS

**ETSI**

650 Route des Lucioles  
F-06921 Sophia Antipolis Cedex - FRANCE

Tel.: +33 4 92 94 42 00 Fax: +33 4 93 65 47 16

Siret N° 348 623 562 00017 - NAF 742 C  
Association à but non lucratif enregistrée à la  
Sous-Préfecture de Grasse (06) N° 7803/88

---

**Important notice**

Individual copies of the present document can be downloaded from:

<http://www.etsi.org>

The present document may be made available in more than one electronic version or in print. In any case of existing or perceived difference in contents between such versions, the reference version is the Portable Document Format (PDF). In case of dispute, the reference shall be the printing on ETSI printers of the PDF version kept on a specific network drive within ETSI Secretariat.

Users of the present document should be aware that the document may be subject to revision or change of status. Information on the current status of this and other ETSI documents is available at

<http://portal.etsi.org/tb/status/status.asp>

If you find errors in the present document, please send your comment to one of the following services:

[http://portal.etsi.org/chaicor/ETSI\\_support.asp](http://portal.etsi.org/chaicor/ETSI_support.asp)

---

**Copyright Notification**

No part may be reproduced except as authorized by written permission.  
The copyright and the foregoing restriction extend to reproduction in all media.

© European Telecommunications Standards Institute 2005.  
All rights reserved.

**DECT**<sup>TM</sup>, **PLUGTESTS**<sup>TM</sup> and **UMTS**<sup>TM</sup> are Trade Marks of ETSI registered for the benefit of its Members.  
**TIPHON**<sup>TM</sup> and the **TIPHON logo** are Trade Marks currently being registered by ETSI for the benefit of its Members.  
**3GPP**<sup>TM</sup> is a Trade Mark of ETSI registered for the benefit of its Members and of the 3GPP Organizational Partners.

---

## Intellectual Property Rights

IPRs essential or potentially essential to the present document may have been declared to ETSI. The information pertaining to these essential IPRs, if any, is publicly available for **ETSI members and non-members**, and can be found in ETSI SR 000 314: *"Intellectual Property Rights (IPRs); Essential, or potentially Essential, IPRs notified to ETSI in respect of ETSI standards"*, which is available from the ETSI Secretariat. Latest updates are available on the ETSI Web server (<http://webapp.etsi.org/IPR/home.asp>).

Pursuant to the ETSI IPR Policy, no investigation, including IPR searches, has been carried out by ETSI. No guarantee can be given as to the existence of other IPRs not referenced in ETSI SR 000 314 (or the updates on the ETSI Web server) which are, or may be, or may become, essential to the present document.

---

## Foreword

This Technical Specification (TS) has been produced by ETSI 3rd Generation Partnership Project (3GPP).

The present document may refer to technical specifications or reports using their 3GPP identities, UMTS identities or GSM identities. These should be interpreted as being references to the corresponding ETSI deliverables.

The cross reference between GSM, UMTS, 3GPP and ETSI identities can be found under <http://webapp.etsi.org/key/queryform.asp>.

# Contents

Intellectual Property Rights .....	2
Foreword.....	2
Foreword.....	15
Introduction .....	15
1 Scope .....	16
2 References .....	16
3 Definitions and abbreviations.....	17
3.1 Definitions .....	17
3.2 Abbreviations .....	19
3.3 Measurement definition template .....	20
3.4 Definition of private Object Classes .....	23
3.4.1 Routing Area.....	23
3.4.2 MMS Relay/Server .....	23
3.5 Management of per cause measurements .....	23
4 Measurements related to the RNC.....	24
4.1 RAB management .....	24
4.1.1 Overview .....	24
4.1.1.1 Measurements are based on the success and failure of procedures .....	24
4.1.1.2 Combination of Traffic Class and Core Network domains .....	24
4.1.1.3 Considered Radio Access Bearer management procedures .....	24
4.1.1.4 Measurements relate to RAB establishment, modification and release .....	25
4.1.2 RAB establishment for CS domain.....	25
4.1.2.1 Attempted RAB establishments for CS domain.....	25
4.1.2.2 Successful RAB establishments without queuing for CS domain.....	26
4.1.2.3 Failed RAB establishments without queuing for CS domain.....	26
4.1.2.4 Successful RAB establishments with queuing for CS domain.....	27
4.1.2.5 Failed RAB establishments with queuing for CS domain.....	27
4.1.3 RAB establishmentfor PS domain .....	28
4.1.3.1 Attempted RAB establishments for PS domain .....	28
4.1.3.2 Successful RAB establishments without queuing for PS domain .....	28
4.1.3.3 Failed RAB establishments without queuing for PS domain .....	29
4.1.3.4 Successful RAB establishments with queuing for PS domain .....	29
4.1.3.5 Failed RAB establishments with queuing for PS domain .....	29
4.1.4 RAB modification for CS domain .....	30
4.1.4.1 Attempted RAB modifications for CS domain .....	30
4.1.4.2 Successful RAB modifications without queuing for CS domain .....	30
4.1.4.3 Failed RAB modifications without queuing for CS domain .....	31
4.1.4.4 Successful RAB modifications with queuing for CS domain .....	31
4.1.4.5 Failed RAB modifications with queuing for CS domain .....	32
4.1.5 RAB modification for PS domain.....	32
4.1.5.1 Attempted RAB modifications for PS domain.....	32
4.1.5.2 Successful RAB modifications without queuing for PS domain.....	33
4.1.5.3 Failed RAB modifications without queuing for PS domain.....	33
4.1.5.4 Successful RAB modifications with queuing for PS domain.....	34
4.1.5.5 Failed RAB modifications with queuing for PS domain.....	34
4.1.6 RAB release request by CN for CS domain.....	34
4.1.6.1 Attempted RAB releases for CS domain.....	35
4.1.6.2 Successful RAB releases without queuing for CS domain.....	35
4.1.6.3 Failed RAB releases without queuing for CS domain.....	35
4.1.6.4 Successful RAB releases with queuing for CS domain.....	36
4.1.6.5 Failed RAB releases with queuing for CS domain.....	36
4.1.7 RAB release request by CN for PS domain .....	37
4.1.7.1 Attempted RAB releases for PS domain .....	37

4.1.7.2	Successful RAB releases without queuing for PS domain .....	37
4.1.7.3	Failed RAB releases without queuing for PS domain .....	38
4.1.7.4	Successful RAB releases with queuing for PS domain .....	38
4.1.7.5	Failed RAB releases with queuing for PS domain .....	39
4.1.8	RAB setup time.....	39
4.1.8.1	RAB CS connection set-up time (Mean).....	39
4.1.8.2	RAB CS connection set-up time (Maximum) .....	39
4.1.8.3	RAB PS connection set-up time (Mean) .....	40
4.1.8.4	RAB PS connection set-up time (Maximum).....	40
4.1.9	RAB release request by UTRAN .....	41
4.1.9.1	RAB release requests for CS domain .....	41
4.1.9.2	RAB release requests for PS domain .....	41
4.2	Void.....	42
4.3	Signalling connection establishment .....	42
4.3.1	Attempted signalling connection establishments for CS domain.....	42
4.3.2	Attempted signalling connection establishments for PS domain .....	42
4.4	RRC connection establishment.....	42
4.4.1	RRC connection establishments .....	42
4.4.1.1	Attempted RRC connection establishments .....	42
4.4.1.2	Failed RRC connection establishments.....	43
4.4.1.3	Successful RRC connection establishments.....	43
4.4.2	RRC connection establishment setup time.....	44
4.4.2.1	RRC connection set-up time (Mean).....	44
4.4.2.2	RRC connection set-up time (Max) .....	44
4.5	RRC connection re-establishment .....	45
4.5.1	Attempted RRC re-establishments .....	45
4.5.2	Failed RRC re-establishments.....	45
4.5.3	Successful RRC re-establishments .....	46
4.6	RRC connection release .....	46
4.6.1	Attempted RRC connection releases on DCCH.....	46
4.6.2	Attempted RRC connection releases on CCCH.....	47
4.7	RLC connection.....	47
4.7.1	Number of RLC blocks sent (per Mode) .....	47
4.7.2	Number of RLC blocks Received (per Mode).....	47
4.7.3	Discarded RLC blocks by RNC.....	48
4.7.4	Number of Retransmitted RLC blocks in Acknowledge Mode .....	48
4.8	Soft handover .....	48
4.8.1	Radio link additions to active link set (UE side).....	48
4.8.1.1	Attempted radio link additions to active link set (UE side) .....	48
4.8.1.2	Successful radio link additions to active link set (UE side) .....	49
4.8.1.3	Failed radio link additions to active link set (UE side) .....	49
4.8.2	Radio link deletions from active link set (UE side) .....	50
4.8.2.1	Attempted radio link deletions from active link set (UE side).....	50
4.8.2.2	Successful radio link deletions from active link set (UE side).....	50
4.9	Radio link management procedures .....	50
4.9.1	Overview .....	50
4.9.1.1	Considered radio link management procedures .....	50
4.9.1.2	Relation between Iub measurements and Iur measurements .....	53
4.9.2	Radio link setups on Iub .....	54
4.9.2.1	Attempted radio link setups on Iub .....	54
4.9.2.2	Successful radio link setups on Iub .....	54
4.9.2.3	Failed radio link setups on Iub .....	55
4.9.3	Radio link setups on Iur .....	55
4.9.3.1	Attempted radio link setups on Iur.....	55
4.9.3.2	Successful radio link setups on Iur.....	56
4.9.3.3	Failed radio link setups on Iur.....	56
4.9.4	Radio link additions on Iub.....	57
4.9.4.1	Attempted radio link additions on Iub.....	57
4.9.4.2	Successful radio link additions on Iub .....	57
4.9.4.3	Failed radio link additions on Iub .....	58
4.9.5	Radio link additions on Iur .....	58
4.9.5.1	Attempted radio link additions on Iur .....	58

4.9.5.2	Successful radio link additions on Iur .....	58
4.9.5.3	Failed radio link additions on Iur .....	59
4.9.6	Radio link deletions on Iub .....	59
4.9.6.1	Attempted radio link deletions on Iub .....	59
4.9.6.2	Successful radio link deletions on Iub .....	60
4.9.7	Radio link deletions on Iur .....	60
4.9.7.1	Attempted radio link deletions on Iur .....	60
4.9.7.2	Successful radio link deletions on Iur .....	61
4.10	Hard handover .....	61
4.10.1	Void .....	61
4.10.2	Outgoing intra-NodeB hard handovers .....	61
4.10.2.1	Attempted outgoing intra-NodeB hard handovers .....	61
4.10.2.2	Successful outgoing intra-NodeB hard handovers .....	61
4.10.2.3	Failed outgoing intra-NodeB hard handovers .....	62
4.10.3	Outgoing inter-NodeB, intra-RNC hard handovers .....	62
4.10.3.1	Attempted outgoing inter-NodeB, intra-RNC hard handovers .....	62
4.10.3.2	Successful outgoing inter-NodeB, intra-RNC hard handovers .....	63
4.10.3.3	Failed outgoing inter-NodeB, intra-RNC hard handovers .....	63
4.10.4	Outgoing inter-RNC hard handovers via Iur .....	64
4.10.4.1	Attempted outgoing inter-RNC hard handovers via Iur .....	64
4.10.4.2	Successful outgoing inter-RNC hard handovers via Iur .....	64
4.10.4.3	Failed outgoing inter-RNC hard handovers via Iur .....	65
4.10.5	Relocation preparation for outgoing inter-RNC hard handovers switching in the CN .....	65
4.10.5.1	Attempted relocation preparation for outgoing inter-RNC hard handovers switching in the CN .....	65
4.10.5.2	Successful relocation preparation for outgoing inter-RNC hard handovers switching in the CN .....	66
4.10.5.3	Failed relocation preparation for outgoing inter-RNC hard handovers switching in the CN .....	66
4.10.6	Outgoing inter-RNC hard handovers switching in the CN .....	66
4.10.6.1	Attempted outgoing inter-RNC hard handovers switching in the CN .....	66
4.10.6.2	Successful outgoing inter-RNC hard handovers switching in the CN .....	67
4.10.6.3	Failed outgoing inter-RNC hard handovers switching in the CN .....	67
4.11	Relocation .....	68
4.11.1	Relocations for CS domain .....	68
4.11.1.1	Relocation preparations with UE involved for CS domain .....	68
4.11.1.1.1	Attempted relocation preparations with UE involved for CS domain .....	68
4.11.1.1.2	Successful relocation preparations with UE involved for CS domain .....	68
4.11.1.1.3	Failed relocation preparations with UE involved for CS domain .....	68
4.11.1.2	Relocation preparations with UE not involved for CS domain .....	69
4.11.1.2.1	Attempted relocation preparations with UE not involved for CS domain .....	69
4.11.1.2.2	Successful relocation preparations with UE not involved for CS domain .....	69
4.11.1.2.3	Failed relocation preparations with UE not involved for CS domain .....	70
4.11.1.3	Relocation resource allocations with UE involved for CS domain .....	70
4.11.1.3.1	Attempted relocations resource allocations with UE involved for CS domain .....	70
4.11.1.3.2	Successful relocation resource allocations with UE involved for CS domain .....	71
4.11.1.3.3	Failed relocation resource allocations with UE involved for CS domain .....	71
4.11.1.4	Relocation resource allocations with UE not involved for CS domain .....	71
4.11.1.4.1	Attempted relocations resource allocations with UE not involved for CS domain .....	71
4.11.1.4.2	Successful relocation resource allocations with UE not involved for CS domain .....	72
4.11.1.4.3	Failed relocation resource allocations with UE not involved for CS domain .....	72
4.11.1.5	Relocations for CS domain .....	73
4.11.1.5.1	Successful relocations for CS domain .....	73
4.11.2	Relocations for PS domain .....	73
4.11.2.1	Relocation preparations with UE involved for PS domain .....	73
4.11.2.1.1	Attempted relocation preparations with UE involved for PS domain .....	73
4.11.2.1.2	Successful relocation preparations with UE involved for PS domain .....	73
4.11.2.1.3	Failed relocation preparations with UE involved for PS domain .....	74
4.11.2.2	Relocation preparations with UE not involved for PS domain .....	74
4.11.2.2.1	Attempted relocation preparations with UE not involved for PS domain .....	74
4.11.2.2.2	Successful relocation preparations with UE not involved for PS domain .....	75
4.11.2.2.3	Failed relocation preparations with UE not involved for PS domain .....	75
4.11.2.3	Relocation resource allocations with UE involved for PS domain .....	75
4.11.2.3.1	Attempted relocations resource allocations with UE involved for PS domain .....	75
4.11.2.3.2	Successful relocation resource allocations with UE involved for PS domain .....	76

4.11.2.3.3	Failed relocation resource allocations with UE involved for PS domain .....	76
4.11.2.4	Relocation resource allocations with UE not involved for PS domain .....	77
4.11.2.4.1	Attempted relocations resource allocations with UE not involved for PS domain .....	77
4.11.2.4.2	Successful relocation resource allocations with UE not involved for PS domain .....	77
4.11.2.4.3	Failed relocation resource allocations with UE not involved for PS domain .....	77
4.11.2.5	Relocations for PS domain.....	78
4.11.2.5.1	Successful relocations for PS domain.....	78
4.12	Circuit switched inter-RAT handover .....	78
4.12.1	Relocation preparation for outgoing circuit switched inter-RAT handovers .....	78
4.12.1.1	Attempted relocation preparation for outgoing circuit switched inter-RAT handovers .....	78
4.12.1.2	Successful relocation preparation for outgoing circuit switched inter-RAT handovers .....	79
4.12.1.3	Failed relocation preparation for outgoing circuit switched inter-RAT handovers .....	79
4.12.2	Outgoing circuit switched inter-RAT handovers .....	79
4.12.2.1	Attempted outgoing circuit switched inter-RAT handovers.....	79
4.12.2.2	Successful outgoing circuit switched inter-RAT handovers .....	80
4.12.2.3	Failed outgoing circuit switched inter-RAT handovers .....	80
4.12.3	Incoming circuit switched inter-RAT handovers.....	80
4.12.3.1	Attempted incoming circuit switched inter-RAT handovers.....	80
4.12.3.2	Successful incoming circuit switched inter-RAT handovers .....	81
4.12.3.3	Failed incoming circuit switched inter-RAT handovers.....	81
4.13	Packet switched inter-RAT handover .....	81
4.13.1	Outgoing packet switched inter-RAT handovers, UTRAN controlled .....	81
4.13.1.1	Attempted outgoing packet switched inter-RAT handovers, UTRAN controlled.....	82
4.13.1.2	Successful outgoing packet switched inter-RAT handovers, UTRAN controlled .....	82
4.13.1.3	Failed outgoing packet switched inter-RAT handovers UTRAN controlled .....	82
4.13.2	Outgoing packet switched inter-RAT handovers, UE controlled.....	83
4.13.2.1	Successful outgoing packet switched inter-RAT handovers, UE controlled.....	83
4.14	Iu connection release .....	83
4.14.1	Overview .....	83
4.14.1.1	Considered Iu connection release procedures .....	83
4.14.2	Iu connection release request by UTRAN .....	84
4.14.2.1	Attempted Iu connection release request by UTRAN for CS domain.....	84
4.14.2.2	Attempted Iu connection release request by UTRAN for PS domain .....	84
4.14.3	Iu connection release by CN .....	85
4.14.3.1	Attempted Iu connection release by CN for CS domain .....	85
4.14.3.2	Attempted Iu connection release by CN for PS domain.....	85
4.14.3.3	Successful Iu connection release by CN for CS domain .....	85
4.14.3.4	Successful Iu connection release by CN for PS domain .....	86
5	Measurements related to the SGSN.....	86
5.1	Mobility Management .....	86
5.1.1	GPRS attach procedures .....	86
5.1.1.1	Attempted GPRS attach procedures .....	86
5.1.1.2	Successful GPRS attach procedures.....	87
5.1.1.3	Failed GPRS attach procedures.....	87
5.1.1.4	Aborted GPRS attach procedures.....	88
5.1.2	Intra-SGSN Routing Area update procedures.....	88
5.1.2.1	Attempted intra-SGSN Routing Area update procedures.....	88
5.1.2.2	Successful intra-SGSN Routing Area update procedures .....	89
5.1.3	GPRS detach procedures initiated by MS.....	89
5.1.3.1	Attempted GPRS detach procedures initiated by MS .....	89
5.1.4	GPRS detach procedures initiated by SGSN .....	89
5.1.4.1	Attempted GPRS detach procedures initiated by SGSN.....	89
5.1.4.2	Successful GPRS detach procedures initiated by SGSN.....	90
5.1.5	Inter-SGSN Routing Area update procedures.....	90
5.1.5.1	Attempted inter-SGSN Routing Area update procedures.....	90
5.1.5.2	Successful inter-SGSN Routing Area update procedures .....	91
5.1.6	GPRS attach procedures with IMSI already attached .....	91
5.1.6.1	Attempted GPRS attach procedures with IMSI already attached.....	91
5.1.6.2	Successful GPRS attach procedures with IMSI already attached .....	92
5.1.6.3	Failed GPRS attach procedures with IMSI already attached .....	92
5.1.6.4	Aborted GPRS attach procedures with IMSI already attached .....	93

5.1.7	IMSI detach procedures initiated by MS .....	93
5.1.7.1	Attempted IMSI detach procedures initiated by MS .....	93
5.1.8	Combined GPRS/IMSI attach procedures .....	93
5.1.8.1	Attempted combined GPRS/IMSI attach procedures .....	94
5.1.8.2	Successful combined GPRS/IMSI attach procedures .....	94
5.1.8.3	Failed combined GPRS/IMSI attach procedures .....	94
5.1.8.4	Aborted combined GPRS/IMSI attach procedures .....	95
5.1.9	Combined GPRS/IMSI detach procedures initiated by MS .....	95
5.1.9.1	Attempted combined GPRS/IMSI detach procedures initiated by MS .....	95
5.1.10	Combined RA/LA intra-SGSN Routing Area update procedures .....	96
5.1.10.1	Attempted combined RA/LA intra-SGSN Routing Area update procedures .....	96
5.1.10.2	Successful combined RA/LA intra-SGSN Routing Area update procedures .....	96
5.1.11	"Combined RA/LA with IMSI Attach" intra-SGSN Routing Area update procedures .....	97
5.1.11.1	Attempted "combined RA/LA with IMSI Attach" intra-SGSN Routing Area update procedures .....	97
5.1.12	Combined RA/LA inter-SGSN Routing Area update procedures .....	97
5.1.12.1	Attempted combined RA/LA inter-SGSN Routing Area update procedures .....	97
5.1.12.2	Successful combined RA/LA inter-SGSN Routing Area update procedures .....	98
5.1.13	"Combined RA/LA with IMSI Attach" inter-SGSN Routing Area update procedures .....	98
5.1.13.1	Attempted "combined RA/LA with IMSI Attach" inter-SGSN Routing Area update procedures .....	98
5.1.14	Number of received invalid P-TMSI's during detach .....	98
5.1.15	GSM PS paging procedures .....	99
5.1.15.1	Attempted GSM PS paging procedures .....	99
5.1.15.2	Successful GSM PS paging procedures .....	99
5.1.15.3	Failed GSM PS paging procedures .....	100
5.1.16	UMTS PS paging procedures .....	100
5.1.16.1	Attempted UMTS PS paging procedures .....	100
5.1.16.2	Successful UMTS PS paging procedures .....	100
5.1.16.3	Failed UMTS PS paging procedures .....	101
5.1.17	PS paging procedures with unknown access type .....	101
5.1.17.1	Attempted PS paging procedures with unknown access type .....	101
5.1.18	Number of PS paging message sends from 2G-SGSN to the MS .....	101
5.1.19	Number of PS paging message sends from 3G-SGSN to the MS .....	102
5.1.20	GSM subscribers state .....	102
5.1.20.1	Subscribers in STANDBY state .....	102
5.1.20.1.1	Number of subscribers in STANDBY state .....	102
5.1.20.1.2	Mean number of subscribers in STANDBY state .....	102
5.1.20.1.3	Max number of subscribers in STANDBY state .....	102
5.1.20.2	Subscribers in READY state .....	103
5.1.20.2.1	Number of subscribers in READY state .....	103
5.1.20.2.2	Mean number of subscribers in READY state .....	103
5.1.20.2.3	Max number of subscribers in READY state .....	103
5.1.21	UMTS subscribers state .....	104
5.1.21.1	Subscribers in PMM-IDLE state .....	104
5.1.21.1.1	Number of subscribers in PMM-IDLE state .....	104
5.1.21.1.2	Mean number of subscribers in PMM-IDLE state .....	104
5.1.21.1.3	Max number of subscribers in PMM-IDLE state .....	104
5.1.21.2	Subscribers in PMM-CONNECTED state .....	105
5.1.21.2.1	Number of subscribers in PMM-CONNECTED state .....	105
5.1.21.2.2	Mean number of subscribers in PMM-CONNECTED state .....	105
5.1.21.2.3	Max number of subscribers in PMM-CONNECTED state .....	105
5.1.22	Attached subscribers .....	106
5.1.22.1	Number of attached subscribers .....	106
5.1.22.2	Mean number of attached subscribers .....	106
5.1.22.3	Max number of attached subscribers .....	106
5.1.23	Home subscribers .....	107
5.1.23.1	Number of home subscribers .....	107
5.1.23.2	Mean number of home subscribers .....	107
5.1.23.3	Max number of home subscribers .....	108
5.1.24	Visiting national subscribers .....	108
5.1.24.1	Number of visiting national subscribers .....	108
5.1.24.2	Mean number of visiting national subscribers .....	109
5.1.24.3	Max number of visiting national subscribers .....	109



5.1.25	Visiting foreign subscribers .....	109
5.1.25.1	Number of visiting foreign subscribers .....	109
5.1.25.2	Mean number of visiting foreign subscribers .....	110
5.1.25.3	Max number of visiting foreign subscribers.....	110
5.1.26	Void .....	111
5.1.27	Void .....	111
5.1.28	Void .....	111
5.1.29	Void .....	111
5.1.30	CAMEL subscribers .....	111
5.1.30.1	Number of CAMEL subscribers .....	111
5.1.30.2	Mean Number of CAMEL subscribers .....	111
5.1.30.3	Max number of CAMEL subscribers .....	112
5.1.31	Void .....	112
5.1.32	InsertSubscriberData requests received from a HLR during GPRS Update Location procedure .....	112
5.1.32.1	Attempted InsertSubscriberData requests received from a HLR during GPRS Update Location procedure.....	112
5.1.33	GPRS Update Locations sent to the HLR.....	113
5.1.33.1	Attempted GPRS Update Locations sent to the HLR .....	113
5.1.33.2	Successful GPRS Update Locations returned from the HLR.....	113
5.1.34	CancelLocation requests received from an HLR-operator, in case of a HLR-initiated Detach .....	113
5.1.34.1	Attempted CancelLocation requests received from an HLR-operator, in case of a HLR-initiated Detach .....	113
5.1.35	CancelLocation requests received from a HLR due to a SGSN-change (previous SGSN).....	114
5.1.35.1	Attempted CancelLocation requests received from a HLR due to a SGSN-change (previous SGSN) .....	114
5.1.36	Reset requests received from a HLR due to an HLR restart, indicating that a failure occurred .....	114
5.1.36.1	Attempted Reset requests received from a HLR due to an HLR restart, indicating that a failure occurred.....	114
5.2	Subscriber Management .....	114
5.2.1	Insert Subscriber Data requests received from a HLR due to an HLR-operator intervention.....	114
5.2.1.1	Attempted Insert Subscriber Data requests received from a HLR due to an HLR-operator intervention .....	114
5.2.2	Delete Subscriber Data requests received from a HLR due to an HLR-operator intervention .....	115
5.2.2.1	Attempted Delete Subscriber Data requests received from a HLR due to an HLR-operator intervention .....	115
5.3	SRNS Relocation.....	115
5.3.1	Intra 3G-SGSN SRNS Relocations.....	115
5.3.1.1	Attempted intra 3G-SGSN SRNS Relocations .....	116
5.3.1.2	Successful intra 3G-SGSN SRNS Relocations .....	116
5.3.1.3	Failed intra 3G-SGSN SRNS Relocations, due to internal reasons.....	116
5.3.1.4	Failed intra 3G-SGSN SRNS Relocations, due to external reasons .....	116
5.3.2	Inter 3G-SGSN SRNS Relocations.....	117
5.3.2.1	Attempted inter 3G-SGSN SRNS Relocations, counted in the old 3G-SGSN.....	117
5.3.2.2	Successful inter 3G-SGSN SRNS Relocations, counted in the old 3G-SGSN .....	117
5.3.2.3	Failed inter 3G-SGSN SRNS Relocations, due to internal reasons, counted in the old 3G-SGSN.....	117
5.3.2.4	Failed inter 3G-SGSN SRNS Relocations, due to external reasons, counted in the old 3G-SGSN ....	118
5.3.3	Inter 3G-SGSN SRNS Relocations, counted in the new 3G-SGSN .....	118
5.3.3.1	Attempted inter 3G-SGSN SRNS Relocations, counted in the new 3G-SGSN .....	118
5.3.3.2	Successful Inter 3G-SGSN SRNS Relocations, counted in the new 3G-SGSN.....	118
5.4	Security .....	119
5.4.1	P-TMSI reallocation procedures .....	119
5.4.1.1	Attempted P-TMSI reallocation procedures.....	119
5.4.1.2	Successful P-TMSI reallocation procedures .....	119
5.4.2	Identity Request procedures initiated by this SGSN.....	120
5.4.2.1	Attempted Identity Request procedures initiated by this SGSN .....	120
5.4.2.2	Successful completed Identity Request procedures initiated by this SGSN.....	120
5.4.3	Identification information requests sent to a partner (previous) SGSN for subscribers registering afresh in this SGSN.....	121
5.4.3.1	Attempted identification information requests sent to a partner (previous) SGSN for subscribers registering afresh in this SGSN .....	121
5.4.3.2	Successful replied identification information requests that were sent to a partner (previous) SGSN .....	121

5.4.4	Attempted Identity Requests sent to the MS.....	122
5.4.4.1	Attempted Identity Requests sent to the MS.....	122
5.4.4.2	Successful replied Identity Requests from the MS.....	122
5.4.5	Authentication procedures that are started within this SGSN area for a subscriber using a SIM.....	122
5.4.5.1	Attempted authentication procedures that are started within this SGSN area for a subscriber using a SIM.....	122
5.4.5.2	Successful authentication procedures within this SGSN area, for a subscriber using a SIM.....	123
5.4.6	Authentication procedures that are started within this SGSN area for a subscriber using a USIM.....	123
5.4.6.1	Attempted authentication procedures that are started within this SGSN area for a subscriber using a USIM.....	123
5.4.6.2	Successful authentication procedures within this SGSN area, for a subscriber using a USIM.....	124
5.4.6.3	Received ciphering and Authentication failures within this SGSN area.....	124
5.4.7	Identification information requests that were received from a partner (new) SGSN for subscribers de-registering from this SGSN.....	125
5.4.7.1	Attempted identification information requests that were received from a partner (new) SGSN for subscribers de-registering from this SGSN.....	125
5.4.7.2	Successfully replied identification information requests that were received from a partner (new) SGSN.....	125
5.4.8	SGSN context requests sent to a partner (previous) SGSN for subscribers registering afresh in this SGSN.....	126
5.4.8.1	Attempted SGSN context requests sent to a partner (previous) SGSN for subscribers registering afresh in this SGSN.....	126
5.4.8.2	Successfully replied SGSN context requests that were sent to a partner (previous) SGSN.....	126
5.4.9	SGSN context requests received from a partner (new) SGSN for a subscriber de-registering from this SGSN.....	127
5.4.9.1	Attempted SGSN context requests received from a partner (new) SGSN for a subscriber de-registering from this SGSN.....	127
5.4.9.2	Successfully replied SGSN context requests received from a partner (new) SGSN.....	127
5.4.10	Number of P-TMSI - IMSI correlation failures (User Identity Confidentiality (TS 23.060)).....	127
5.4.11	Security mode control procedures started by the SGSN.....	128
5.4.11.1	Attempted security mode control procedures started by the SGSN.....	128
5.4.11.2	Successful security mode procedures.....	128
5.4.12	Ciphering procedures started by the SGSN.....	128
5.4.12.1	Attempted GSM ciphering procedures started by the SGSN.....	128
5.4.12.2	Successful GSM ciphering procedures started by the SGSN.....	129
5.4.12.3	Attempted UMTS ciphering procedures started by the SGSN.....	129
5.4.12.4	Successful UMTS ciphering procedures started by the SGSN.....	129
5.4.13	MAP V1 requests for authentication sets.....	130
5.4.13.1	Attempted MAP V1 requests for authentication sets, sent to the HLR by SGSN.....	130
5.4.13.2	Successful MAP V1 requests for authentication sets that were sent to the HLR.....	130
5.4.13.3	Number of empty responses to the MAP V1 request for authentication sets that were sent to the HLR.....	130
5.4.14	MAP V3 requests for Authentication sets.....	131
5.4.14.1	Attempted MAP V3 requests for Authentication sets sent to the HLR by SGSN.....	131
5.4.14.2	Successful MAP V3 requests for authentication sets that were sent to the HLR.....	131
5.4.14.3	Number of empty responses to the MAP V3 request for authentication sets that were sent to the HLR.....	131
5.5	SMS.....	132
5.5.1	SMS in the CS domain (MSC).....	132
5.5.1.1	CS SMS mobile originating.....	132
5.5.1.1.1	Attempted CS SMS mobile originating.....	132
5.5.1.1.2	Successful CS SMS mobile originating.....	132
5.5.1.2	CS SMS mobile terminating.....	133
5.5.1.2.1	Attempted CS SMS mobile terminating.....	133
5.5.1.2.2	Successful CS SMS mobile terminating.....	133
5.5.1.3	CS ms-Present.....	133
5.5.1.3.1	Attempted CS ms-Present.....	133
5.5.1.3.2	Successful CS ms-Present.....	134
5.5.1.4	CS "memory available".....	134
5.5.1.4.1	Attempted CS "memory available".....	134
5.5.1.4.2	Successful CS "memory available".....	135
5.5.2	SMS in the PS domain (SGSN).....	135

5.5.2.1	PS SMS mobile originating.....	135
5.5.2.1.1	Attempted PS SMS mobile originating .....	135
5.5.2.1.2	Successful PS SMS mobile originating .....	135
5.5.2.2	PS SMS mobile terminating.....	136
5.5.2.2.1	Attempted PS SMS mobile terminating .....	136
5.5.2.2.2	Successful PS SMS mobile terminating .....	136
5.5.2.3	PS ms-Present .....	137
5.5.2.3.1	Attempted PS ms-Present .....	137
5.5.2.3.2	Successful PS ms-Present .....	137
5.5.2.4	PS "memory available" .....	138
5.5.2.4.1	Attempted PS "memory available" .....	138
5.5.2.4.2	Successful PS "memory available" .....	138
5.5.3	SMS in the CS/PS domain (MSC/SGSN).....	138
5.5.3.1	SMS mobile originating .....	139
5.5.3.1.1	Attempted SMS mobile originating.....	139
5.5.3.1.2	Successful SMS mobile originating.....	139
5.5.3.2	SMS mobile terminating .....	139
5.5.3.2.1	Attempted SMS mobile terminating .....	139
5.5.3.2.2	Successful SMS mobile terminating.....	140
5.5.3.3	Ms-Present .....	140
5.5.3.3.1	Attempted ms-Present .....	140
5.5.3.3.2	Successful ms-Present .....	141
5.5.3.4	"Memory available" .....	141
5.5.3.4.1	Attempted "memory available" .....	141
5.5.3.4.2	Successful "memory available" .....	141
5.6	Session Management.....	142
5.6.1	PDP context activation procedures initiated by MS .....	142
5.6.1.1	Attempted PDP context activation procedures initiated by MS .....	142
5.6.1.2	Successful PDP context activation procedures initiated by MS .....	142
5.6.1.3	Failed PDP context activation procedures initiated by MS .....	143
5.6.2	dynamic PDP context activation procedures initiated by MS.....	143
5.6.2.1	Attempted dynamic PDP context activation procedures initiated by MS .....	143
5.6.2.2	Successful dynamic PDP context activation procedures initiated by MS .....	144
5.6.3	Mean number of activated PDP contexts .....	144
5.6.4	PDP context deactivation procedures initiated by the MS .....	144
5.6.4.1	Attempted PDP context deactivation procedures initiated by the MS .....	144
5.6.4.2	Successful PDP context deactivation procedures initiated by the MS .....	145
5.6.5	Number of active PDP context .....	145
5.6.6	Subscribers with activated PDP context .....	146
5.6.6.1	Number of subscribers with activated PDP context .....	146
5.6.6.2	Mean number of subscribers with activated PDP context.....	146
5.6.6.3	Max number of subscribers with activated PDP context.....	146
5.6.7	Void .....	147
5.6.8	PDP context deactivation procedures initiated by the GGSN.....	147
5.6.8.1	Attempted PDP context deactivation procedures initiated by the GGSN .....	147
5.6.8.2	Successful PDP context deactivation procedures initiated by the GGSN .....	147
5.6.9	PDP context deactivation procedures initiated by the SGSN .....	148
5.6.9.1	Attempted PDP context deactivation procedures initiated by the SGSN .....	148
5.6.9.2	Successful PDP context deactivations initiated by the SGSN.....	148
5.6.9.3	Abnormal PDP context Deactivation procedures.....	148
5.6.10	SGSN-Initiated PDP context update procedures.....	149
5.6.10.1	Attempted SGSN-Initiated PDP context update procedures .....	149
5.6.10.2	Successful SGSN-Initiated PDP context update procedures .....	149
5.6.11	GGSN-Initiated PDP context update procedures.....	150
5.6.11.1	Attempted GGSN-Initiated PDP context update procedures .....	150
5.6.11.2	Successful GGSN-Initiated PDP context update procedures .....	150
5.6.12	SGSN-Initiated PDP context modifications procedures .....	151
5.6.12.1	Attempted SGSN-Initiated PDP context modifications procedures.....	151
5.6.12.2	Successfully SGSN-Initiated PDP context modifications procedures.....	151
5.6.13	MS-Initiated PDP context modifications procedures.....	151
5.6.13.1	Attempted MS-Initiated PDP context modifications procedures .....	151
5.6.13.2	Successfully MS-Initiated PDP context modifications procedures .....	152

5.6.14	Secondary PDP context activation procedures .....	152
5.6.14.1	Attempted Secondary PDP context activation procedures .....	152
5.6.14.2	Successful Secondary PDP context activations.....	153
5.6.15	PDP context activation procedures initiated by Network .....	153
5.6.15.1	Attempted PDP context activation procedures initiated by Network.....	153
5.6.15.2	Successful PDP context activation procedures initiated by Network.....	153
5.6.15.3	Failed PDP context activation procedures initiated by Network.....	154
5.6.16	PDP Context set-up time, initiated by MS (Mean) .....	154
5.6.17	PDP Context set-up time, initiated by MS (Max) .....	155
5.6.18	PDP Context set-up time, initiated by Network (Mean) .....	155
5.6.19	PDP Context set-up time, initiated by Network (Max) .....	156
5.7	CAMEL Measurements.....	156
5.7.1	CAMEL dialogues .....	156
5.7.1.1	Attempted CAMEL dialogues.....	156
5.7.1.2	Failed CAMEL dialogues, aborted locally by gprsSSF .....	156
5.7.1.3	Failed CAMEL dialogues, error or reject from gsmSCF .....	157
5.8	UMTS-GSM Intersystem Change .....	157
5.8.1	Intra SGSN inter system changes from UMTS to GSM .....	157
5.8.1.1	Attempted intra SGSN inter system changes from UMTS to GSM.....	157
5.8.1.2	Successful intra SGSN inter system changes from UMTS to GSM.....	158
5.8.1.3	Failed intra SGSN inter system changes UMTS to GSM RAU, due to internal reasons .....	158
5.8.1.4	Failed intra SGSN inter system changes UMTS to GSM RAU, due to external reasons.....	158
5.8.2	Intra SGSN inter system changes from GSM to UMTS .....	159
5.8.2.1	Attempted intra SGSN inter system changes from GSM to UMTS.....	159
5.8.2.2	Successful intra SGSN inter system changes from GSM to UMTS.....	159
5.8.2.3	Failed intra SGSN inter system changes GSM to UMTS RAU, due to internal reasons .....	159
5.8.2.4	Failed intra SGSN inter system changes GSM to UMTS RAU, due to external reasons.....	159
5.9	UMTS GTP Measurements .....	160
5.9.1	GTP-U Iu .....	160
5.9.1.1	Number of outgoing GTP data packets on the Iu interface .....	160
5.9.1.2	Number of incoming GTP data packets on the Iu interface .....	160
5.9.1.3	Number of octets of outgoing GTP data packets on the Iu interface.....	160
5.9.1.4	Number of octets of incoming GTP data packets on the Iu interface.....	161
5.9.2	GTP Gn.....	161
5.9.2.1	Number of outgoing GTP data packets on the Gn interface, from SGSN to GGSN.....	161
5.9.2.2	Number of incoming GTP data packets on the Gn interface, from GGSN to SGSN .....	162
5.9.2.3	Number of octets of outgoing GTP data packets on the Gn interface, from SGSN to GGSN .....	162
5.9.2.4	Number of octets of incoming GTP data packets on the Gn interface, from GGSN to SGSN .....	162
5.9.2.5	Number of outgoing GTP signalling packets on the Gn interface, from SGSN to GGSN.....	163
5.9.2.6	Number of incoming GTP signalling packets on the Gn interface, from GGSN to SGSN.....	163
5.9.2.7	Number of octets of outgoing GTP signalling packets on the Gn interface, from SGSN to GGSN ..	164
5.9.2.8	Number of octets of incoming GTP signalling packets on the Gn interface, from GGSN to SGSN ..	164
5.9.2.9	Number of outgoing GTP data packets on the Gn interface, from SGSN to SGSN.....	164
5.9.2.10	Number of incoming GTP data packets on the Gn interface, from SGSN to SGSN.....	165
5.9.2.11	Number of octets of outgoing GTP data packets on the Gn interface, from SGSN to SGSN .....	165
5.9.2.12	Number of octets of incoming GTP data packets on the Gn interface, from SGSN to SGSN .....	166
5.9.2.13	Number of outgoing GTP signalling packets on the Gn interface, from SGSN to SGSN .....	166
5.9.2.14	Number of incoming GTP signalling packets on the Gn interface, from SGSN to SGSN.....	166
5.9.2.15	Number of octets of outgoing GTP signalling packets on the Gn interface, from SGSN to SGSN....	167
5.9.2.16	Number of octets of incoming GTP signalling packets on the Gn interface, from SGSN to SGSN ...	167
5.10	UMTS Bearer Service .....	168
5.10.1	UMTS Bearer Service CS time to register (Mean) .....	168
5.10.2	UMTS Bearer Service CS time to register (Max) .....	168
5.10.3	UMTS Bearer Service PS time to register (Mean).....	168
5.10.4	UMTS Bearer Service PS time to register (Max) .....	169
5.10.5	UMTS Bearer Service time to establish Communications Management (CM) radio access connectivity (Mean).....	169
5.10.6	UMTS Bearer Service time to establish Communications Management (CM) radio access connectivity (Max).....	170
5.11	LLC frames .....	170
5.11.1	Number of LLC frames sent .....	170
5.11.2	Number of LLC frames received .....	170

5.11.3	Number of erroneous LLC frames received.....	171
5.11.4	Number of LLC frames retransmitted.....	171
5.12	SNDCP N-PDUs .....	171
5.12.1	Number of SNDCP N-PDUs sent.....	171
5.12.2	Number of SNDCP N-PDU octets sent .....	171
5.12.3	Number of SNDCP N-PDUs received.....	172
5.12.4	Number of SNDCP N-PDU octets received .....	172
5.13	IMEI checking procedure.....	172
5.13.1	Number of check IMEI requests .....	172
5.13.2	Number of check IMEI white list responses.....	173
5.13.3	Number of check IMEI grey list responses.....	173
5.13.4	Number of check IMEI black list responses .....	173
5.13.5	Number of check IMEI unknown equipment responses .....	174
6	Measurements related to the GGSN .....	174
6.1	Session Management.....	174
6.1.1	Session establishments.....	174
6.1.1.1	Attempted session establishments .....	175
6.1.1.2	Successful session establishments.....	176
6.1.1.3	Failed session establishments.....	176
6.1.2	Network-initiated session establishments .....	177
6.1.2.1	Number of routing information requests for network-initiated session establishment attempts .....	177
6.1.2.2	Number of routing information successful responses for network-initiated session establishment attempts .....	178
6.1.2.3	Attempted Network-initiated session establishments.....	178
6.1.2.3.1	Attempted Network-initiated session establishments .....	178
6.1.2.3.2	Failed Network-initiated session establishments - failures occurred before sending PDP context activation request to the MS .....	178
6.1.2.3.3	Failed Network-initiated session establishments - failures occurred after sending PDP context activation request to the MS .....	179
6.1.3	Subscribers with activated PDP context .....	179
6.1.3.1	Number of subscribers with activated PDP context .....	179
6.1.3.2	Mean number of subscribers with activated PDP context.....	180
6.1.3.3	Max number of subscribers with activated PDP context.....	180
6.1.4	Session conclusions .....	180
6.1.4.1	MS & SGSN-initiated session conclusions .....	181
6.1.4.1.1	Attempted MS & SGSN-initiated session conclusions.....	181
6.1.4.1.2	Successful MS & SGSN-initiated session conclusions .....	182
6.1.4.2	GGSN-initiated session conclusions .....	182
6.1.4.2.1	Attempted GGSN-initiated session conclusions.....	182
6.1.4.2.2	Successful GGSN-initiated session conclusions.....	182
6.2	Per APN measurements.....	183
6.2.1	Session establishments.....	183
6.2.1.1	Session establishments, per APN.....	184
6.2.1.1.1	Attempted session establishments, per APN .....	184
6.2.1.1.2	Successfully established sessions, per APN.....	185
6.2.1.2	Session establishments with dynamic PDP address allocation required, per APN .....	185
6.2.1.2.1	Attempted session establishments with dynamic PDP address allocation required, per APN.....	185
6.2.1.2.2	Successfully established sessions with dynamic PDP address allocation required, per APN .....	185
6.2.1.3	Session establishments with user authentication required, per APN.....	186
6.2.1.3.1	Attempted session establishments with user authentication required, per APN .....	186
6.2.1.3.2	Failed session establishments due to user authentication failure, per APN .....	186
6.2.2	Active sessions.....	187
6.2.2.1	Number of simultaneous active sessions, per APN.....	187
6.2.2.2	Peak number of simultaneous active sessions, per APN .....	187
6.2.2.3	MS & SGSN-initiated session modifications, per APN .....	188
6.2.2.3.1	Attempted MS & SGSN-initiated session modifications, per APN.....	188
6.2.2.3.2	Successfully performed MS & SGSN-initiated session modifications, per APN.....	188
6.2.3	Session conclusions .....	188
6.2.3.1	MS-initiated session conclusions, per APN .....	188
6.2.3.1.1	Attempted MS-initiated session conclusions, per APN .....	188
6.2.3.1.2	Successful MS-initiated session conclusions, per APN.....	189

6.2.3.2	GGSN-initiated session conclusions, per APN .....	189
6.2.3.2.1	Attempted GGSN-initiated session conclusions, per APN .....	189
6.2.3.2.2	Successful GGSN-initiated session conclusions, per APN .....	189
6.3	GTP measurements.....	190
6.3.1	Number of incoming GTP data packets on the Gn interface .....	190
6.3.2	Number of outgoing GTP data packets on the Gn interface .....	190
6.3.3	Number of discarded GTP data packets.....	191
6.3.4	Number of octets of incoming GTP data packets on the Gn interface.....	191
6.3.5	Number of octets of outgoing GTP data packets on the Gn interface.....	192
6.3.6	Number of incoming GTP signalling packets on the Gn interface .....	192
6.3.7	Number of outgoing GTP signalling packets on the Gn interface .....	193
6.3.8	Number of discarded GTP signalling packets.....	193
6.3.9	Number of octets of incoming GTP signalling packets on the Gn interface.....	194
6.3.10	Number of octets of outgoing GTP signalling packets on the Gn interface.....	194
6.3.11	Number of GTP tunnels on the Gn interface .....	195
6.3.12	Number of GTP tunnels created on the Gn interface.....	195
6.4	GTP' measurements.....	195
6.4.1	Attempted CDR information transfers.....	196
6.4.2	Successful CDR information transfers.....	196
6.4.3	Failed CDR information transfers.....	197
6.5	IP measurements .....	197
6.5.1	Number of incoming IP data packets on the Gi interface .....	198
6.5.2	Number of outgoing IP data packets on the Gi interface .....	199
6.5.3	Number of IP data packets discarded due to node congestion.....	199
6.5.4	Number of octets of incoming IP data packets on the Gi interface.....	199
6.5.5	Number of octets of outgoing IP data packets on the Gi interface.....	200
7	Measurements related to the MMS Relay/Server.....	201
7.1	MM1.....	203
7.1.1	Number of Multimedia Messages submit requests received by MMS Relay/Server.....	203
7.1.2	Number of Multimedia Messages submit responses sent by MMS Relay/Server .....	204
7.1.3	Number of Multimedia Messages notification requests sent by MMS Relay/Server .....	204
7.1.4	Number of Multimedia Messages notification responses received by MMS Relay/Server.....	204
7.1.5	Number of Multimedia Messages retrieve requests received by MMS Relay/Server .....	205
7.1.6	Number of Multimedia Messages retrieve responses sent by MMS Relay/Server .....	205
7.1.7	Number of Multimedia Messages acknowledgement requests received by MMS Relay/Server.....	205
7.1.8	Number of Multimedia Messages forward requests received by MMS Relay/Server .....	206
7.1.9	Number of Multimedia Messages forward responses sent by MMS Relay/Server.....	206
7.1.10	Number of Multimedia Messages delivery report requests sent by MMS Relay/Server .....	206
7.1.11	Number of Multimedia Messages read reply recipient requests received by MMS Relay/Server.....	207
7.1.12	Number of Multimedia Messages read reply originator requests sent by MMS Relay/Server.....	207
7.2	MM4.....	207
7.2.1	Number of Multimedia Messages forward requests received by MMS Relay/Server .....	207
7.2.2	Number of Multimedia Messages forward requests sent by MMS Relay/Server .....	208
7.2.3	Number of Multimedia Messages forward responses received by MMS Relay/Server.....	208
7.2.4	Number of Multimedia Messages forward responses sent by MMS Relay/Server.....	208
7.2.5	Number of Multimedia Messages delivery report requests received by MMS Relay/Server .....	209
7.2.6	Number of Multimedia Messages delivery report requests sent by MMS Relay/Server .....	209
7.2.7	Number of Multimedia Messages delivery report responses received by MMS Relay/Server.....	209
7.2.8	Number of Multimedia Messages delivery report responses sent by MMS Relay/Server.....	210
7.2.9	Number of Multimedia Messages read reply requests received by MMS Relay/Server.....	210
7.2.10	Number of Multimedia Messages read reply requests sent by MMS Relay/Server.....	210
7.2.11	Number of Multimedia Messages read reply responses received by MMS Relay/Server .....	211
7.2.12	Number of Multimedia Messages read reply responses sent by MMS Relay/Server .....	211
<b>Annex A (informative):</b>	<b>Examples for "(n-1) out of n" approach.....</b>	<b>212</b>
A.1	Attempt/success/failure procedure measurements .....	212
A.2	GSM/UMTS combined measurements.....	212
A.3	Embedded "(n-1) out of n" approaches .....	213

<b>Annex B (informative):</b>	<b>Top-Down Performance Measurement Definition Process.....</b>	<b>214</b>
B.1	Scope of this annex.....	214
B.2	Overview .....	214
B.3	Measurement User Communities .....	215
B.3.1	Network Operator Business Community.....	215
B.3.2	Network Operator Maintenance Community .....	215
B.3.3	Network Operator Traffic Engineering Community .....	216
B.3.4	Network Operator Customer Care Community.....	216
B.3.5	Equipment Vendor Performance Modelling Community.....	216
B.3.6	Equipment Vendor Development Engineering Community.....	217
B.3.7	User Community Conclusion .....	217
B.4	Enhanced GQM.....	217
B.4.1	GQM Methodology .....	217
B.4.2	Enhanced GQM (EGQM) Methodology .....	218
B.5	Measurements Life Cycle Process .....	220
B.6	Conclusion.....	221
<b>Annex C (informative):</b>	<b>Change history .....</b>	<b>222</b>
History .....		224

---

## Foreword

This Technical Specification has been produced by the 3<sup>rd</sup> Generation Partnership Project (3GPP).

The contents of the present document are subject to continuing work within the TSG and may change following formal TSG approval. Should the TSG modify the contents of the present document, it will be re-released by the TSG with an identifying change of release date and an increase in version number as follows:

Version x.y.z

where:

- x the first digit:
  - 1 presented to TSG for information;
  - 2 presented to TSG for approval;
  - 3 or greater indicates TSG approved document under change control.
- y the second digit is incremented for all changes of substance, i.e. technical enhancements, corrections, updates, etc.
- z the third digit is incremented when editorial only changes have been incorporated in the document.

---

## Introduction

The present document is part of a TS-family covering the 3rd Generation Partnership Project; Technical Specification Group Services and System Aspects; Telecommunication Management; as identified below:

- TS 32.401: "Performance Management (PM); Concept and requirements";
- TS 52.402: "Performance Management (PM); Performance measurements - GSM";
- TS 32.403: "Performance Management (PM); Performance measurements UMTS and combined UMTS/GSM".**

The present document is part of a set of specifications, which describe the requirements and information model necessary for the standardised Operation, Administration and Maintenance (OA&M) of a multi-vendor 3G-system.

During the lifetime of a 3G network, its logical and physical configuration will undergo changes of varying degrees and frequencies in order to optimise the utilisation of the network resources. These changes will be executed through network configuration management activities and/or network engineering, see TS 32.600 [3].

Many of the activities involved in the daily operation and future network planning of a 3G network require data on which to base decisions. This data refers to the load carried by the network and the grade of service offered. In order to produce this data performance measurements are executed in the NEs, which comprise the network. The data can then be transferred to an external system, e.g. an Operations System (OS) in TMN terminology, for further evaluation. The purpose of the present document is to describe the mechanisms involved in the collection of the data and the definition of the data itself.

Annex B has been added to help in the definition of new performance measurements that can be submitted to 3GPP for potential adoption and inclusion in the present document. Annex B discusses a top-down performance measurement definition methodology that focuses on how the end-user of performance measurements can use the measurements.



---

# 1 Scope

The present document describes the measurements for UMTS and combined UMTS/GSM.

TS 32.401 [12] describes Performance Management concepts and requirements.

The present document is valid for all measurement types provided by an implementation of a UMTS network and combined UMTS/GSM network.

Only measurement types that are specific to UMTS or combined UMTS/GSM networks are defined within the present documents. Vendor specific measurement types used in UMTS and combined UMTS/GSM networks are not covered. Instead, these could be applied according to manufacturer's documentation.

Measurements related to "external" technologies (such as ATM or IP) as described by "external" standards bodies (e.g. ITU-T or IETF) shall only be referenced within this specification, wherever there is a need identified for the existence of such a reference.

The definition of the standard measurements is intended to result in comparability of measurement data produced in a multi-vendor network, for those measurement types that can be standardised across all vendors' implementations.

The structure of the present document is as follows:

- Header 1: Network Element (e.g. RNC related measurements);
- Header 2: Measurement function (e.g. soft handover measurements);
- Header 3: Measurements.

---

# 2 References

The following documents contain provisions which, through reference in this text, constitute provisions of the present document.

- References are either specific (identified by date of publication and/or edition number or version number) or non-specific.
- For a specific reference, subsequent revisions do not apply.
- For a non-specific reference, the latest version applies. In the case of a reference to a 3GPP document (including a GSM document), a non-specific reference implicitly refers to the latest version of that document *in the same Release as the present document*.

[1] 3GPP TS 32.101: "Telecommunication management; Principles and high level requirements".

[2] 3GPP TS 32.102: "Telecommunication management; Architecture".

[3] 3GPP TS 32.600: "Telecommunication management; Configuration Management (CM); Concept and high-level requirements".

[4] 3GPP TS 25.331: "Radio Resource Control (RRC) protocol specification".

[5] 3GPP TS 25.413: "UTRAN Iu Interface RANAP signalling".

[6] 3GPP TS 25.423: "UTRAN Iur Interface RNSAP signalling".

[7] 3GPP TS 25.433: "UTRAN Iub Interface NBAP signalling".

[8] 3GPP TS 23.107: "Quality of Service (QoS) concept and architecture".

[9] 3GPP TS 32.622: "Telecommunication management; Configuration Management (CM); Generic network resources Integration Reference Point (IRP); Network Resource Model (NRM)".

- [10] 3GPP TS 32.632: "Telecommunication management; Configuration Management (CM); Core Network Resources Integration Reference Point (IRP): Network Resource Model (NRM)".
- [11] 3GPP TS 32.642: "Telecommunication management; Configuration Management (CM); UTRAN network resources Integration Reference Point (IRP): Network Resource Model (NRM)".
- [12] 3GPP TS 32.401: "Telecommunication management; Performance Management (PM); Concept and requirements".
- [13] GSM 12.04: "Digital cellular telecommunications system (Phase 2+); Performance data measurements".
- [14] 3GPP TS 52.402: "Telecommunication management; Performance Management (PM); Performance measurements - GSM".
- [15] 3GPP TS 24.008: "Mobile Radio Interface Layer 3 specification; Core Network Protocols; Stage 3".
- [16] GSM 08.18: "Digital cellular telecommunication system (Phase 2); General Packet Radio Service (GPRS); Base Station System (BSS) - Serving GPRS Support Node (SGSN); BSS GPRS Protocol (BSSGP)".
- [17] 3GPP TS 23.060: "General Packet Radio Service (GPRS) Service description; Stage 2".
- [18] 3GPP TS 29.002: "Mobile Application Part (MAP) specification".
- [19] 3GPP TS 29.060: "General Packet Radio Service (GPRS); GPRS Tunnelling Protocol (GTP) across the Gn and Gp interface".
- [20] 3GPP TS 24.011: "Point-to-Point (PP) Short Message Service (SMS) support on mobile radio interface".
- [21] 3GPP TS 23.003: "Numbering, Addressing and Identification".
- [22] Victor R Basili and H. Dieter Rombach: "The TAME project: Towards improvement-oriented software environments", IEEE Transactions of Software Engineering, Vol. 14, No. 6, June 1988.
- [23] Victor R Basili and David M. Weiss: "A Methodology for Collecting Valid Software Engineering Data", IEEE Transactions of Software Engineering, Vol. SE- 10, No. 6, November 1984.
- [24] 3GPP TS 25.322: "Radio Link Control (RLC) protocol specification".
- [25] 3GPP TS 23.140: "Multimedia Messaging Service (MMS); Functional description; Stage 2".
- [26] 3GPP TS 29.061: "Interworking between the Public Land Mobile Network (PLMN) supporting packet based services and Packet Data Networks (PDN)".
- [27] 3GPP TS 44.064: "Digital cellular telecommunications system (Phase 2+); General Packet Radio Service (GPRS); Mobile Station - Serving GPRS Support Node (MS-SGSN) Logical Link Control (LLC) layer specification".
- [28] 3GPP TS 44.065: "Digital cellular telecommunications system (Phase 2+); General Packet Radio Service (GPRS); Mobile Station (MS) - Serving GPRS Support Node (SGSN); Subnetwork Dependent Convergence Protocol (SNDCCP)".

---

## 3 Definitions and abbreviations

### 3.1 Definitions

For the purposes of the present document, the following terms and definitions apply:

**"(n-1) out of n" approach:**

- The measurements result values generated by a NE can be obtained in a number of different ways. Therefore, the "(n-1) out of n approach" has been defined in order to avoid redundancy in the measurements.
- The "(n-1) out of n approach" allows a vendor to choose any (n-1) out of the n defined counters for implementation but some choices can offer more detailed information than others. The missing n<sup>th</sup> value can be calculated in post-processing.
- If multiple measurements are included in one template, then the applicability of the "(n-1) out of n" scenario are mentioned in template item A with the following sentence "The n measurement types defined in item E are subject to the "(n-1) out of n approach"". The item D will specify the measurement result per measurement type specified in template item E.
- If the measurements that are applicable to the "(n-1) out of n" scenario are defined in separate templates, then they will be grouped together into a common clause of the TS, and the applicability of the approach will be mentioned in the clause that groups the measurements.
- Examples of measurements which are subject to the "(n-1) out of n" approach are provided in the annex A.

### Measurement community

Several measurement communities are defined in the present document to identify the end users of system measurements. Each measurement should be defined to address the needs of at least one of these user communities.

Six communities have been identified so far:

- Network Operator's Business Community.
- Network Operator's Maintenance Community.
- Network Operator's Traffic Engineering Community.
- Network Operator's Customer Care Community.
- Equipment Vendor's Performance Modelling Community.
- Equipment Vendor's Development Engineering Community.

A comprehensive description of measurement communities is provided in Annex B. The user communities names are a composite of the various terms used in the industry and might be subject to modification or refinement in future releases.

### Measurement family

The measurement names defined in the present document are all beginning with a prefix containing the measurement family name (e.g. RAB.AttEstabCS.Conv, MM.AttGprsAttach). This family name identifies all measurements which relate to a given functionality and it may be used for measurement administration (see TS 32.401 [12]).

The list of families currently used in the present document is as follows:

- CAM (measurements related to CAMEL).
- GTP (measurements related to GTP).
- HHO (measurements related to Hard Handover).
- IMEI (measurements related to IMEI verification).
- IRATHO (measurements related to inter-Radio Access Technology Handover).
- ISYSC (measurements related to GSM/UMTS Intersystem changes).
- IU (measurements related to Iu connection).
- LLC (measurements related to Logical Link Control).
- MM (measurements related to Mobility Management).

- MMS (measurements related to Multimedia Messaging Services).
- RAB (measurements related to Radio Access Bearer management).
- RELOC (measurements related to SRNS Relocation).
- RLC (measurements related to Radio Link Control).
- RLM (measurements related to Radio Link Management)
- RRC (measurements related to Radio Resource Control).
- SEC (measurements related to Security).
- SHO (measurements related to Soft Handover).
- SIG (measurements related to Signalling).
- SM (measurements related to Session Management).
- SMS (measurements related to Short Message Service).
- SNDCP (measurements related to Sub-Network Dependent Convergence Protocol).
- SUB (measurements related to Subscriber Management).
- UBS (measurements related to UMTS Bearer Service).

## 3.2 Abbreviations

For the purposes of the present document, the following abbreviations apply:

3G	3 <sup>rd</sup> Generation
3GPP	3G Partnership Project
ASN.1	Abstract Syntax Notation 1
BER	Basic Encoding Rules
CN	Core Network
DTD	Document Type Definition
EGQM	Enhanced Goal, Question, Metric
EM	(Network) Element Manager
FTAM	File Transfer Access and Management
FTP	File Transfer Protocol
GQM	Goal, Question, Metric
IEEE	Institute of Electrical and Electronics Engineers, Inc.
Itf	Interface
ITU-T	International Telecommunication Union - Telecommunications Standardisation Sector
MSC	Mobile services Switching Centre
NE	Network Element
NM	Network Manager
OA&M	Operation, Administration and Maintenance
OS	Operations System (EM, NM)
OSI	Open Systems Interconnection
PM	Performance Management
QoS	Quality of Service
RNC	Radio Network Controller
TFTP	Trivial FTP
UMTS	Universal Mobile Telecommunications System
UTRAN	Universal Terrestrial Radio Access Network

You can find below a list of abbreviations used within the measurement types for field E of the measurement template (see subclause 3.3).

Assn	Assign(ment,ed)
Att	Attempt(s,ed)
Auth	Authentication
Bgrd	Background
Call	Call
Chg	Change
Conn	Connection
Combi	Combined
CS	Circuit switched
Ctrl	Controlled
Conv	Conversational
Del	Deletion
Drop	Drop(ped)
Estab	Establish (ed,ment)
Fail	Fail(ed, ure)
HHO	Hard Handover
HO	Handover
Inc	Incoming
Intact	Interactive
Inter	Inter
Intra	Intra
Invol	Involve(d)
MM	Mobility Management
Nat	National
Netw	Network
NodeB	NodeB
Oct	Octet(s)
Out	Outgoing
Pkt	Packet(s)
Prep	Preparation
Proc	Procedure
PS	Packet switched
RAB	Radio Access Bearer
RAT	Radio Access Technology
ReEstab	Re-establish (ed,ment)
Rel	Released
Reloc	Relocation
Req	Request(s,ed)
Res	Resource
RL	Radio Link
RNC	RNC
RRC	Radio Resource Control
Setup	Setup
SGSN	SGSN
SHO	Soft Handover
Sig	Signalling
Strm	Streaming
Sub	Subscriber
Succ	Success(es,ful)
UE	User Equipment
UTRAN	UTRAN

### 3.3 Measurement definition template

Following is the template used to describe the measurements contained in this subclause.

**C.x.y. Measurement Name (clause header)**

This is a descriptive name of the measurement type that is specified as clause C.x.y of the present document.

The measurement name shall be written in lower-case characters except abbreviations (e.g. RNC).

A measurement name can apply to one or more measurements. If the measurement name applies to several measurements then all fields of the template will take this into account.

Measurement names shall not exceed 64 characters in length and should be constrained to 32 characters maximum. Exceptions greater than 32 characters are allowed but should be kept to a minimum and only made where necessary.

#### a) Description

This subclause contains an explanation of the measurement operation.

#### b) Collection Method

This contains the form in which this measurement data is obtained:

- **CC** (Cumulative Counter);
- **GAUGE** (dynamic variable), used when data being measured can vary up or down during the period of measurement;
- **DER** (Discrete Event Registration), when data related to a particular event are captured every  $n^{\text{th}}$  event is registered, where  $n$  can be 1 or larger;
- **SI** (Status Inspection).

#### c) Condition

This subclause contains the condition which causes the measurement result data to be updated; This will be defined by identifying protocol related trigger events for starting and stopping measurement processes, or updating the current measurement result value. Where it is not possible to give a precise condition, then the conditional circumstances leading to the update are stated.

If a measurement is not available for FDD or TDD, then the measurement description shall contain a statement.

#### d) Measurement Result (measured value(s), Units)

This subclause contains a description of expected result value(s) (e.g. a single integer value).

The definition applies for each measurement result.

#### e) Measurement Type

This subclause contains a short form of the measurement name specified in the header, which is used to identify the measurement type in the result files.

The measurement names are dotted sequences of items. The sequence of elements identifying a measurement is organised from the general to the particular.

- The first item identifies the measurement family (e.g. HHO, RAB, SMS). Note that this family may also be used for measurement administration purpose.
- The second item identifies the name of the measurement itself.
- Depending on the measurement type, additional items may be present to specify subcounters (failure causes, traffic classes, min, max, avg, G, U ...). In case of multiple additional items, they are also represented as a dotted sequence of items. When available, the template will describe to which standard it is referring to for these additional items (e.g. cause, traffic class). Otherwise, the additional item semantics must be described in details in the present document. Standardised causes will be a number. (e.g. RRC.ConnEstab.1) but non standardised causes should be a string (e.g. RRC.ConnEstab.NoReply).

It is to be noted that the set of values issued for a measurement does not depend on the associated collection method (CC, SI, Gauge, DER). For instance, a gauge collected counter does not necessarily provide min, max, average values.

The vendor-specific UMTS and combined GSM/UMTS measurement names will all begin with the VS prefix.

In addition, it is recommended that a prefix is added for non-UMTS measurements:

- Q3 for Q3 measurements;
- MIB for IETF measurements (ATM, IP);
- OS for other standards measurements.

NOTE 1: The 3GPP standardised measurements name must not commence with the above prefixes.

Examples of valid measurement names are:

- VS.HO.InterSGSNReject.NoResource;
- HHO.SuccOutIntraCell;
- MM.AttachedSubs.Max;
- RAB.EstabAttCS.Conversational;
- RRC.ConnEstab.*Cause*  
where *Cause* identifies the failure cause.

Abbreviations to be used within measurement types can be found in subclause 3.2 of the present document.

#### f) Measurement Object Class

This subclause describes the measured object class (e.g. UtranCell, RncFunction, SgsnFunction). The object class used for this purpose shall be in accordance with the Network Resource Model defined in 3GPP TS 32.622 [9], TS 32.632 [10] and TS 32.642 [11].

For object classes currently not defined in CM, the present document defines its own nomenclature (e.g. RA, LAC).

NOTE: It is possible to use the same measurement name for a standardized measurement type implemented at a different object class level than the one defined in the Standard. The same measurement type can apply to one or more measurements for which all fields of the measurement template are the same except the clause f) "Measurement Object Class". For instance, a measurement which uses the same template as a given measurement type but relates to another object class (e.g. UtranCell instead of UtranRelation) shall have the same name.

#### g) Switching Technology

This subclause contains the Switching domain(s) this measurement is applicable to i.e. Circuit Switched and/or Packet Switched.

#### h) Generation

The generation determines if it concerns a GSM, UMTS, or combined (GSM+UMTS) measurement.

- **GSM:** pure GSM measurement; it only counts GSM events. In a combined (GSM+UMTS) NE the count would be exactly the same as in a pure GSM NE. In a pure UMTS NE this counter does not exist;
- **UMTS:** pure UMTS measurement; it only counts UMTS events. In a combined (GSM+UMTS) NE the count would be exactly the same as in a pure UMTS NE. In a pure GSM NE this counter does not exist;
- **GSM/UMTS:** measurement applicable to both GSM and UMTS systems; in a combined (GSM+UMTS) NE separate subcounts for GSM and/or UMTS events can be obtained;
- **Combined:** measurement applicable to combined GSM and UMTS systems, but regardless of whether the measured event occurred on the GSM or UMTS part of the system. This means that in a combined NE only one total (i.e. GSM+UMTS) count is obtained for the measured event.

The above aspects are also reflected in the measurement type name in template item E by adding a "G" to the GSM measurements and "U" to the UMTS measurements.

NOTE 2: The 2G component of a combined 2G/3G equipment may actually choose to implement GSM measurements according to the present document or GSM12.04/TS 52.402, based on GSM standards.

**i) Purpose**

This optional clause aims at describing who will be using the measurement. It is proposed to indicate in this clause the targeted categories of users based on the measurement user communities described in Annex B.

When available, this clause provides additional information on the interest of the measurement but is however purely indicative.

## 3.4 Definition of private Object Classes

Private Object Classes are Object Classes which are needed for PM purposes, but that are not yet defined by CM.

### 3.4.1 Routing Area

The Object Class Routing Area (RA) is needed to conduct measurements on RA level. For the purpose of the present document, the Routing Area should be encoded in the file format as the concatenation of the MCC, MNC, LAC and the RAC, in decimal notation. See further definition of Routing Area Identification in TS 23.003 [21]. Since LAC is a 2 byte number (00000-65535), 5 characters are needed in the moid PrintableString. Since RAC is a 1 byte number (000-255) 3 characters are needed in the moid PrintableString. MCC is 3 digits and MNC 2 or 3 digits. The concatenated moid PrintableString will always contain 14 characters. In the case where MNC has the length 2, a leading underscore character will be added.

EXAMPLE 1: LAC = Hexadecimal 4E20 = Decimal 20000;  
RAC = Hexadecimal BE = Decimal 190; MCC = Decimal 046; MNC = Decimal 01  
moid = "046\_0120000190".

The Object Class Routing Area (RA) is needed to conduct measurements on RA level. For the purpose of the present document the Routing Area should be encoded in the file format as the concatenation of the LAC and the RAC, in decimal notation. Since LAC is a 2 byte number (00000-65535) 5 characters are needed in the moid PrintableString. Since RAC is a 1 byte number (000-255) 3 characters are needed in the moid PrintableString. Hence concatenated moid PrintableString will always contain 8 characters.

EXAMPLE 2: LAC = Hexadecimal 4E20 = Decimal 20000;  
RAC = Hexadecimal BE = Decimal 190;  
moid = "20000190".

### 3.4.2 MMS Relay/Server

The Object Class MMS Relay/Server is needed to conduct measurements on MMS Relay/Server level. No specific moid structure is defined for the MMS Relay/Server. The moid is a PrintableString which contains a maximum of 20 characters.

## 3.5 Management of per cause measurements

Per cause measurements may lead in certain cases to a lot of subcounters which will increase substantially the size of the measurement report file. Since all per cause measurements are not necessarily useful to the end-user, two options are possible for the management of the corresponding subcounters:

- support all the subcounters corresponding to the cause codes as defined in the 3GPP standards. In that case, the sum of all supported per cause measurements is equal to the total sum across all subcounters;
- support only a subset of the subcounters (allowed only if the cause codes are specified in 3GPP standards). In that case, the first value of the result sequence must be the total sum across all the cause codes as defined in 3GPP standards. This implies that all subcounters of a given measurement type appear as uninterrupted sequence in the result file. The keyword *.sum* placed behind the measurement type is used to identify the sum subcounter. The choice of the supported cause codes is manufacturer dependent.



---

## 4 Measurements related to the RNC

### 4.1 RAB management

#### 4.1.1 Overview

##### 4.1.1.1 Measurements are based on the success and failure of procedures

The proposed measurements are not merely based on the counting of a given type of message since a same message may be repeated by an implementation dependent process. The aim here is to provide implementation independent specification.

Proposed measurements are based on the success/failure of procedures identified in the reference documents. The end of a procedure implies a stable state of the communication between the two involved parties. This stable state is normally the object of a common understanding from the two parties. As a consequence, proposed measurements are attached either to the successful or the unsuccessful issue of a procedure.

##### 4.1.1.2 Combination of Traffic Class and Core Network domains

A Radio Access Bearer (RAB) is characterized by several QOS parameters among them is the Traffic Class. Currently there are not any 3GPP specifications including TS 23.107 [8] in which may be found restrictions related to the possible combinations between Traffic Class and Core Network domain.

Consequently, as a conservative position, this specification should leave open every possible combination between Traffic Class and Core Network domain as specification TS 23.107 [8] does.

##### 4.1.1.3 Considered Radio Access Bearer management procedures

Performance Measurement definitions in this subclause are based on TS 25.413 "UTRAN Iu Interface RANAP Signalling" [5].

The following paragraphs are of interest for this purpose:

- RAB Assignment;
- RAB Release Request;
- RAB ASSIGNMENT REQUEST;
- RAB ASSIGNMENT RESPONSE;
- RAB RELEASE REQUEST.

These paragraphs show in particular the following diagrams.

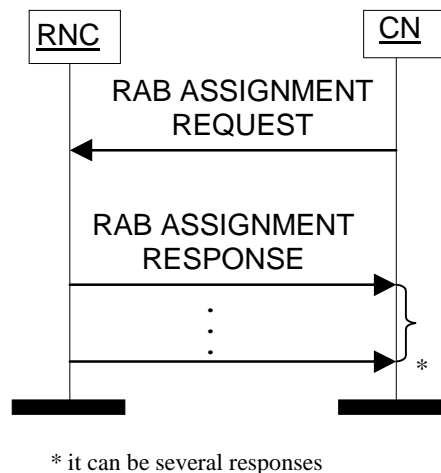

**Figure: RAB Assignment procedure. Successful operation**

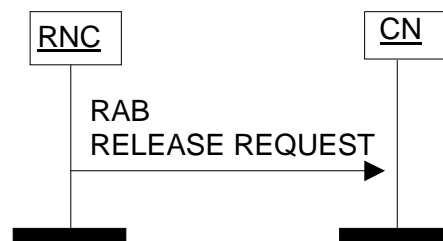

**Figure: RAB Release Request procedure**

#### 4.1.1.4 Measurements relate to RAB establishment, modification and release

RAB management procedure includes RAB Assignment procedure and RAB Release Request procedure. The purpose of RAB Assignment procedure is to establish new RABs and/or to enable modifications and/or releases of already established RABs for a given UE. If RABs are failed to be established or modified, the involved services may fail. RAB release request can be initiated by CN or RNC when the services terminate normally or abnormally.

During daily maintenance of network, measurements regarding RAB establishment, modification and release are useful for operators to evaluate RAB management procedures, to analyze failure reasons of RAB establishment and RAB modification, and to analyze the causes of RAB release, especially in case RAB release abnormally.

### 4.1.2 RAB establishment for CS domain

The five measurement types defined in the clause 4.1.2 for CS domain are subject to the "4 out of 5 approach".

#### 4.1.2.1 Attempted RAB establishments for CS domain

- a) This measurement provides the number of requested RAB in establishment attempts for CS domain. The measurement is split into subcounters per traffic class.
- b) CC.
- c) On receipt by the RNC of a RANAP RAB ASSIGNMENT REQUEST message for CS domain, each requested RAB in establishment attempts is added to the relevant measurement according to the traffic class requested. See TS 25.413 [5] and TS 23.107 [8].

**NOTE:** The addition is performed with the condition that the RAB has not been setup or modified successfully in a previous RANAP RAB ASSIGNMENT RESPONSE or RELOCATION REQUEST ACKNOWLEDGE.

- d) Four integer values.
- e) RAB.AttEstabCS.Conv  
RAB.AttEstabCS.Strm  
RAB.AttEstabCS.Intact  
RAB.AttEstabCS.Bgrd
- f) RncFunction.
- g) Valid for circuit switched traffic.
- h) UMTS.

#### 4.1.2.2 Successful RAB establishments without queuing for CS domain

- a) This measurement provides the number of successfully established RABs for CS domain in which a queuing process has not been involved. The measurement is split into subcounters per traffic class.
- b) CC.
- c) On transmission by the RNC of a RANAP RAB ASSIGNMENT RESPONSE message for CS domain, each successfully established RAB is added to the relevant measurement according to the traffic class requested in the RAB ASSIGNMENT REQUEST message. See TS 25.413 [5] and TS 23.107 [8].

NOTE: The addition is performed with the condition that the RAB has not been mentioned as queued in a previous RANAP RAB ASSIGNMENT RESPONSE and the RAB has not been setup or modified successfully in a previous RANAP RAB ASSIGNMENT RESPONSE or RELOCATION REQUEST ACKNOWLEDGE.

- d) Four integer values.
- e) RAB.SuccEstabCSNoQueuing.Conv  
RAB.SuccEstabCSNoQueuing.Strm  
RAB.SuccEstabCSNoQueuing.Intact  
RAB.SuccEstabCSNoQueuing.Bgrd
- f) RncFunction.
- g) Valid for circuit switched traffic.
- h) UMTS.

#### 4.1.2.3 Failed RAB establishments without queuing for CS domain

- a) This measurement provides the number of RABs failed to establish for CS domain in which a queuing process has not been involved. The measurement is split into subcounters per failure cause.
- b) CC.
- c) On transmission by the RNC of a RANAP RAB ASSIGNMENT RESPONSE message for CS domain, each RAB failed to establish is added to the relevant measurement according to the failure cause. Possible causes are included in TS 25.413 [5]. The sum of all supported per cause measurements shall equal the total number of RAB Establishment Failures. In case only a subset of per cause measurements is supported, a sum subcounter will be provided first.

NOTE: The addition is performed with the condition that the RAB has not been mentioned as queued in a previous RANAP RAB ASSIGNMENT RESPONSE and the RAB has not been setup or modified successfully in a previous RANAP RAB ASSIGNMENT RESPONSE or RELOCATION REQUEST ACKNOWLEDGE.

- d) Each measurement is an integer value. The number of measurements is equal to the number of causes supported plus a possible sum value identified by the *.sum* suffix.
- e) The measurement name has the form RAB.FailEstabCSNoQueuing.*Cause* where *Cause* identifies the failure cause.

- f) RncFunction.
- g) Valid for circuit switched traffic.
- h) UMTS.

#### 4.1.2.4 Successful RAB establishments with queuing for CS domain

- a) This measurement provides the number of successfully established RABs for CS domain in which a queuing process has been involved. The measurement is split into subcounters per traffic class.
- b) CC.
- c) On transmission by the RNC of a RANAP RAB ASSIGNMENT RESPONSE message for CS domain, each successfully established RAB is added to the relevant measurement according to the traffic class. See TS 25.413 [5] and TS 23.107 [8].

NOTE: The addition is performed with the condition that the RAB has been mentioned as queued in a previous RANAP RAB ASSIGNMENT RESPONSE and the RAB has not been setup or modified successfully in a previous RANAP RAB ASSIGNMENT RESPONSE or RELOCATION REQUEST ACKNOWLEDGE.

- d) Four integer values.
- e) RAB.SuccEstabCSQueuing.Conv  
RAB.SuccEstabCSQueuing.Strm  
RAB.SuccEstabCSQueuing.Intact  
RAB.SuccEstabCSQueuing.Bgrd
- f) RncFunction.
- g) Valid for circuit switched traffic.
- h) UMTS.

#### 4.1.2.5 Failed RAB establishments with queuing for CS domain

- a) This measurement provides the number of RABs failed to establish for CS domain in which a queuing process has been involved. The measurement is split into subcounters per failure cause.
- b) CC.
- c) On transmission by the RNC of a RANAP RAB ASSIGNMENT RESPONSE message for CS domain, each RAB failed to establish is added to the relevant measurement according to the cause. Possible causes are included in TS 25.413 [5]. The sum of all supported per cause measurements shall equal the total number of RAB Establishment Failures. In case only a subset of per cause measurements is supported, a sum subcounter will be provided first.

NOTE: The addition is performed with the condition that the RAB has been mentioned as queued in a previous RANAP RAB ASSIGNMENT RESPONSE and the RAB has not been setup or modified successfully in a previous RANAP RAB ASSIGNMENT RESPONSE or RELOCATION REQUEST ACKNOWLEDGE.

- d) Each measurement is an integer value. The number of measurements is equal to the number of causes plus a possible sum value identified by the *.sum* suffix.
- e) The measurement name has the form RAB.FailEstabCSQueuing.*Cause* where *Cause* identifies the failure cause.
- f) RncFunction.
- g) Valid for circuit switched traffic.
- h) UMTS.

### 4.1.3 RAB establishment for PS domain

The five measurement types defined in the clause 4.1.3 for PS domain are subject to the "4 out of 5 approach".

#### 4.1.3.1 Attempted RAB establishments for PS domain

- a) This measurement provides the number of requested RABs in establishment attempts for PS domain. The measurement is split into subcounters per traffic class.
- b) CC.
- c) On receipt by the RNC of a RANAP RAB ASSIGNMENT REQUEST message for PS domain, each requested RAB in establishment attempts is added to the relevant measurement according to the traffic class requested. See TS 25.413 [5] and TS 23.107 [8].

NOTE: The addition is performed with the condition that the RAB has not been setup or modified successfully in a previous RANAP RAB ASSIGNMENT RESPONSE or RELOCATION REQUEST ACKNOWLEDGE.

- d) Four integer values.
- e) RAB.AttEstabPS.Conv  
RAB.AttEstabPS.Strm  
RAB.AttEstabPS.Intact  
RAB.AttEstabPS.Bgrd
- f) RncFunction.
- g) Valid for packet switched traffic.
- h) UMTS.

#### 4.1.3.2 Successful RAB establishments without queuing for PS domain

- a) This measurement provides the number of successfully established RABs for PS domain in which a queuing process has not been involved. The measurement is split into subcounters per traffic class.
- b) CC.
- c) On transmission by the RNC of a RANAP RAB ASSIGNMENT RESPONSE message for PS domain, each successfully established RAB is added to the relevant measurement according to the traffic class. See TS 25.413 [5] and TS 23.107 [8].

NOTE: The addition is performed with the condition that the RAB has not been mentioned as queued in a previous RANAP RAB ASSIGNMENT RESPONSE and the RAB has not been setup or modified successfully in a previous RANAP RAB ASSIGNMENT RESPONSE or RELOCATION REQUEST ACKNOWLEDGE.

- d) Four integer values.
- e) RAB.SuccEstabPSNoQueuing.Conv  
RAB.SuccEstabPSNoQueuing.Strm  
RAB.SuccEstabPSNoQueuing.Intact  
RAB.SuccEstabPSNoQueuing.Bgrd
- f) RncFunction.
- g) Valid for packet switched traffic.
- h) UMTS.

#### 4.1.3.3 Failed RAB establishments without queuing for PS domain

- a) This measurement provides the number of RABs failed to establish for PS in which a queuing process has not been involved. The measurement is split into subcounters per failure cause.
- b) CC.
- c) On transmission by the RNC of a RANAP RAB ASSIGNMENT RESPONSE message for PS domain, each RAB failed to establish is added to the relevant measurement according to the failure cause. Possible causes are included in TS 25.413 [5]. The sum of all supported per cause measurements shall equal the total number of RAB Establishment Failures. In case only a subset of per cause measurements is supported, a sum subcounter will be provided first.

NOTE: The addition is performed with the condition that the RAB has not been mentioned as queued in a previous RANAP RAB ASSIGNMENT RESPONSE and the RAB has not been setup or modified successfully in a previous RANAP RAB ASSIGNMENT RESPONSE or RELOCATION REQUEST ACKNOWLEDGE.

- d) Each measurement is an integer value. The number of measurements is equal to the number of causes plus a possible sum value identified by the *.sum* suffix.
- e) The measurement name has the form RAB.FailEstabPSNoQueuing.*Cause* where *Cause* identifies the failure cause.
- f) RncFunction.
- g) Valid for packet switched traffic.
- h) UMTS.

#### 4.1.3.4 Successful RAB establishments with queuing for PS domain

- a) This measurement provides the number of successfully established RABs for PS domain in which a queuing process has been involved. The measurement is split into subcounters per traffic class.
- b) CC.
- c) On transmission by the RNC of a RANAP RAB ASSIGNMENT RESPONSE message for PS domain, each successfully established RAB is added to the relevant measurement according to the traffic class. See TS 25.413 [5] and TS 23.107 [8].

NOTE: The addition is performed with the condition that the RAB has been mentioned as queued in a previous RANAP RAB ASSIGNMENT RESPONSE and the RAB has not been setup or modified successfully in a previous RANAP RAB ASSIGNMENT RESPONSE or RELOCATION REQUEST ACKNOWLEDGE.

- d) Four integer values.
- e) RAB.SuccEstabPSQueuing.Conv  
RAB.SuccEstabPSQueuing.Strm  
RAB.SuccEstabPSQueuing.Intact  
RAB.SuccEstabPSQueuing.Bgrd
- f) RncFunction.
- g) Valid for packet switched traffic.
- h) UMTS.

#### 4.1.3.5 Failed RAB establishments with queuing for PS domain

- a) This measurement provides the number of RABs failed to establish for PS domain in which a queuing process has been involved. The measurement is split into subcounters per failure cause.
- b) CC.

- c) On transmission by the RNC of a RANAP RAB ASSIGNMENT RESPONSE message for PS domain, each RAB failed to establish is added to the relevant measurement according to the cause. Possible causes are included in TS 25.413 [5]. The sum of all supported per cause measurements shall equal the total number of RAB Establishment Failures. In case only a subset of per cause measurements is supported, a sum subcounter will be provided first.

NOTE: The addition is performed with the condition that the RAB has been mentioned as queued in a previous RANAP RAB ASSIGNMENT RESPONSE and the RAB has not been setup or modified successfully in a previous RANAP RAB ASSIGNMENT RESPONSE or RELOCATION REQUEST ACKNOWLEDGE.

- d) Each measurement is an integer value. The number of measurements is equal to the number of causes plus a possible sum value identified by the *.sum* suffix.
- e) The measurement name has the form RAB.FailEstabPSQueuing.*Cause* where *Cause* identifies the failure cause.
- f) RncFunction.
- g) Valid for packet switched traffic.
- h) UMTS.

#### 4.1.4 RAB modification for CS domain

The five measurement types defined in the clause 4.1.4 for CS domain are subject to the "4 out of 5 approach".

##### 4.1.4.1 Attempted RAB modifications for CS domain

- a) This measurement provides the number of requested RABs in modification attempts for CS domain. The measurement is split into subcounters per traffic class.
- b) CC.
- c) On receipt by the RNC of a RANAP RAB ASSIGNMENT REQUEST message for CS domain, each requested RAB in modification attempts is added to the relevant measurement according to the traffic class requested. See TS 25.413 and TS 23.107.

NOTE: The addition is performed with the condition that the RAB has been setup or modified successfully in a previous RANAP RAB ASSIGNMENT RESPONSE or RELOCATION REQUEST ACKNOWLEDGE.

- d) Four integer values.
- e) RAB.AttModCS.Conv  
RAB.AttModCS.Strm  
RAB.AttModCS.Intact  
RAB.AttModCS.Bgrd
- f) RncFunction.
- g) Valid for circuit switched traffic.
- h) UMTS.

##### 4.1.4.2 Successful RAB modifications without queuing for CS domain

- a) This measurement provides the number of successfully modified RABs for CS domain in which a queuing process has not been involved. The measurement is split into subcounters per traffic class.
- b) CC.
- c) On transmission by the RNC of a RANAP RAB ASSIGNMENT RESPONSE message for CS domain, each successfully modified RAB is added to the relevant measurement according to the traffic class requested in the RAB ASSIGNMENT REQUEST message. See TS 25.413 and TS 23.107.

NOTE: The addition is performed with the condition that the RAB has not been mentioned as queued in a previous RANAP RAB ASSIGNMENT RESPONSE and the RAB has been setup or modified successfully in a previous RANAP RAB ASSIGNMENT RESPONSE or RELOCATION REQUEST ACKNOWLEDGE.

- d) Four integer values.
- e) RAB.SuccModCSNoQueuing.Conv  
RAB.SuccModCSNoQueuing.Strm  
RAB.SuccModCSNoQueuing.Intact  
RAB.SuccModCSNoQueuing.Bgrd
- f) RncFunction.
- g) Valid for circuit switched traffic.
- h) UMTS.

#### 4.1.4.3 Failed RAB modifications without queuing for CS domain

- a) This measurement provides the number of RABs failed to modify for CS domain in which a queuing process has not been involved. The measurement is split into subcounters per failure cause.
- b) CC.
- c) On transmission by the RNC of a RANAP RAB ASSIGNMENT RESPONSE message for CS domain, each RAB failed to modify is added to the relevant measurement according to the failure cause. Possible causes are included in TS 25.413. The sum of all supported per cause measurements shall equal the total number of RAB Modification Failures. In case only a subset of per cause measurements is supported, a sum measurement subtype will be provided first.

NOTE: The addition is performed with the condition that the RAB has not been mentioned as queued in a previous RANAP RAB ASSIGNMENT RESPONSE and the RAB has been setup or modified successfully in a previous RANAP RAB ASSIGNMENT RESPONSE or RELOCATION REQUEST ACKNOWLEDGE.

- d) Each measurement is an integer value. The number of measurements is equal to the number of causes supported plus a possible sum value identified by the *.sum* suffix.
- e) The measurement name has the form RAB.FailModCSNoQueuing.*Cause* where *Cause* identifies the failure cause.
- f) RncFunction.
- g) Valid for circuit switched traffic.
- h) UMTS.

#### 4.1.4.4 Successful RAB modifications with queuing for CS domain

- a) This measurement provides the number of successfully modified RABs for CS domain in which a queuing process has been involved. The measurement is split into subcounters per traffic class.
- b) CC.
- c) On transmission by the RNC of a RANAP RAB ASSIGNMENT RESPONSE message for CS domain, each successfully modified RAB is added to the relevant measurement according to the traffic class. See TS 25.413 and TS 23.107.

NOTE: The addition is performed with the condition that the RAB has been mentioned as queued in a previous RANAP RAB ASSIGNMENT RESPONSE and the RAB has been setup or modified successfully in a previous RANAP RAB ASSIGNMENT RESPONSE or RELOCATION REQUEST ACKNOWLEDGE.

- d) Four integer values.



- e) RAB.SuccModCSQueuing.Conv  
RAB.SuccModCSQueuing.Strm  
RAB.SuccModCSQueuing.Intact  
RAB.SuccModCSQueuing.Bgrd
- f) RncFunction.
- g) Valid for circuit switched traffic.
- h) UMTS.

#### 4.1.4.5 Failed RAB modifications with queuing for CS domain

- a) This measurement provides the number of RABs failed to modify for CS domain in which a queuing process has been involved. The measurement is split into subcounters per failure cause.
- b) CC.
- c) On transmission by the RNC of a RANAP RAB ASSIGNMENT RESPONSE message for CS domain, each RAB failed to modify is added to the relevant measurement according to the cause. Possible causes are included in TS 25.413. The sum of all supported per cause measurements shall equal the total number of RAB Modification Failures. In case only a subset of per cause measurements is supported, a sum measurement subtype will be provided first.

NOTE: The addition is performed with the condition that the RAB has been mentioned as queued in a previous RANAP RAB ASSIGNMENT RESPONSE and the RAB has been setup or modified successfully in a previous RANAP RAB ASSIGNMENT RESPONSE or RELOCATION REQUEST ACKNOWLEDGE.

- d) Each measurement is an integer value. The number of measurements is equal to the number of causes plus a possible sum value identified by the *.sum* suffix.
- e) The measurement name has the form RAB.FailModCSQueuing.*Cause* where *Cause* identifies the failure cause.
- f) RncFunction.
- g) Valid for circuit switched traffic.
- h) UMTS.

#### 4.1.5 RAB modification for PS domain

The five measurement types defined in the clause 4.1.5 for PS domain are subject to the "4 out of 5 approach".

##### 4.1.5.1 Attempted RAB modifications for PS domain

- a) This measurement provides the number of requested RABs in modification attempts for PS domain. The measurement is split into subcounters per traffic class.
- b) CC.
- c) On receipt by the RNC of a RANAP RAB ASSIGNMENT REQUEST message for PS domain, each requested RAB in modification attempts is added to the relevant measurement according to the traffic class requested. See TS 25.413 and TS 23.107.

NOTE: The addition is performed with the condition that the RAB has been setup or modified successfully in a previous RANAP RAB ASSIGNMENT RESPONSE or RELOCATION REQUEST ACKNOWLEDGE.

- d) Four integer values.
- e) RAB.AttModPS.Conv  
RAB.AttModPS.Strm  
RAB.AttModPS.Intact  
RAB.AttModPS.Bgrd.

- f) RncFunction.
- g) Valid for packet switched traffic.
- h) UMTS.

#### 4.1.5.2 Successful RAB modifications without queuing for PS domain

- a) This measurement provides the number of successfully modified RABs for PS domain in which a queuing process has not been involved. The measurement is split into subcounters per traffic class.
- b) CC.
- c) On transmission by the RNC of a RANAP RAB ASSIGNMENT RESPONSE message for PS domain, each successfully modified RAB is added to the relevant measurement according to the traffic class. See TS 25.413 and TS 23.107.

NOTE: The addition is performed with the condition that the RAB has not been mentioned as queued in a previous RANAP RAB ASSIGNMENT RESPONSE and the RAB has been setup or modified successfully in a previous RANAP RAB ASSIGNMENT RESPONSE or RELOCATION REQUEST ACKNOWLEDGE.

- d) Four integer values.
- e) RAB.SuccModPSNoQueuing.Conv  
RAB.SuccModPSNoQueuing.Strm  
RAB.SuccModPSNoQueuing.Intact  
RAB.SuccModPSNoQueuing.Bgrd.
- f) RncFunction.
- g) Valid for packet switched traffic.
- h) UMTS.

#### 4.1.5.3 Failed RAB modifications without queuing for PS domain

- a) This measurement provides the number of RABs failed to modify for PS in which a queuing process has not been involved. The measurement is split into subcounters per failure cause.
- b) CC.
- c) On transmission by the RNC of a RANAP RAB ASSIGNMENT RESPONSE message for PS domain, each RAB failed to modify is added to the relevant measurement according to the failure cause. Possible causes are included in TS 25.413. The sum of all supported per cause measurements shall equal the total number of RAB Modification Failures. In case only a subset of per cause measurements is supported, a sum measurement subtype will be provided first.

NOTE: The addition is performed with the condition that the RAB has not been mentioned as queued in a previous RANAP RAB ASSIGNMENT RESPONSE and the RAB has been setup or modified successfully in a previous RANAP RAB ASSIGNMENT RESPONSE or RELOCATION REQUEST ACKNOWLEDGE.

- d) Each measurement is an integer value. The number of measurements is equal to the number of causes plus a possible sum value identified by the *.sum* suffix.
- e) The measurement name has the form RAB.FailModPSNoQueuing.*Cause* where *Cause* identifies the failure cause.
- f) RncFunction.
- g) Valid for packet switched traffic.
- h) UMTS.

#### 4.1.5.4 Successful RAB modifications with queuing for PS domain

- a) This measurement provides the number of successfully modified RABs for PS domain in which a queuing process has been involved. The measurement is split into subcounters per traffic class.
- b) CC.
- c) On transmission by the RNC of a RANAP RAB ASSIGNMENT RESPONSE message for PS domain, each successfully modified RAB is added to the relevant measurement according to the traffic class. See TS 25.413 and TS 23.107.

NOTE: The addition is performed with the condition that the RAB has been mentioned as queued in a previous RANAP RAB ASSIGNMENT RESPONSE and the RAB has been setup or modified successfully in a previous RANAP RAB ASSIGNMENT RESPONSE or RELOCATION REQUEST ACKNOWLEDGE.

- d) Four integer values.
- e) RAB.SuccModPSQueuing.Conv  
RAB.SuccModPSQueuing.Strm  
RAB.SuccModPSQueuing.Intact  
RAB.SuccModPSQueuing.Bgrd.
- f) RncFunction.
- g) Valid for packet switched traffic.
- h) UMTS.

#### 4.1.5.5 Failed RAB modifications with queuing for PS domain

- a) This measurement provides the number of RABs failed to modify for PS domain in which a queuing process has been involved. The measurement is split into subcounters per failure cause.
- b) CC.
- c) On transmission by the RNC of a RANAP RAB ASSIGNMENT RESPONSE message for PS domain, each RAB failed to modify is added to the relevant measurement according to the cause. Possible causes are included in TS 25.413. The sum of all supported per cause measurements shall equal the total number of RAB Modification Failures. In case only a subset of per cause measurements is supported, a sum measurement subtype will be provided first.

NOTE: The addition is performed with the condition that the RAB has been mentioned as queued in a previous RANAP RAB ASSIGNMENT RESPONSE and the RAB has been setup or modified successfully in a previous RANAP RAB ASSIGNMENT RESPONSE or RELOCATION REQUEST ACKNOWLEDGE.

- d) Each measurement is an integer value. The number of measurements is equal to the number of causes plus a possible sum value identified by the *.sum* suffix.
- e) The measurement name has the form RAB.FailModPSQueuing.*Cause* where *Cause* identifies the failure cause.
- f) RncFunction.
- g) Valid for packet switched traffic.
- h) UMTS.

#### 4.1.6 RAB release request by CN for CS domain

The five measurement types defined in the clause 4.1.2 for CS domain are subject to the "4 out of 5 approach".

#### 4.1.6.1 Attempted RAB releases for CS domain

- a) This measurement provides the number of requested RABs in release attempts for CS domain. The measurement is split into subcounters per release cause.
- b) CC.
- c) On receipt by the RNC of a RANAP RAB ASSIGNMENT REQUEST message for CS domain, each requested RAB in release attempts is added to the relevant measurement according to the release cause requested. Possible causes are included in TS 25.413. The sum of all supported per cause measurements shall equal the total number of RAB Release Attempts. In case only a subset of per cause measurements is supported, a sum measurement subtype will be provided first. See TS 25.413 and TS 23.107.
- d) Each measurement is an integer value. The number of measurements is equal to the number of causes plus a possible sum value identified by the *.sum* suffix.
- e) The measurement name has the form RAB.AttRelCS.*Cause* where *Cause* identifies the release cause.
- f) RncFunction.
- g) Valid for circuit switched traffic.
- h) UMTS.

#### 4.1.6.2 Successful RAB releases without queuing for CS domain

- a) This measurement provides the number of successfully released RABs for CS domain in which a queuing process has not been involved. The measurement is split into subcounters per release cause.
- b) CC.
- c) On transmission by the RNC of a RANAP RAB ASSIGNMENT RESPONSE message for CS domain, each successfully released RAB is added to the relevant measurement according to the release cause requested in the RAB ASSIGNMENT REQUEST message. Possible causes are included in TS 25.413. The sum of all supported per cause measurements shall equal the total number of RAB Release Successes. In case only a subset of per cause measurements is supported, a sum measurement subtype will be provided first. See TS 25.413 and TS 23.107.

NOTE: The addition is performed with the condition that the RAB has not been mentioned as queued in a previous RANAP RAB ASSIGNMENT RESPONSE.

- d) Each measurement is an integer value. The number of measurements is equal to the number of causes plus a possible sum value identified by the *.sum* suffix.
- e) The measurement name has the form RAB.SuccRelCSNoQueuing.*Cause* where *Cause* identifies the release cause.
- f) RncFunction.
- g) Valid for circuit switched traffic.
- h) UMTS.

#### 4.1.6.3 Failed RAB releases without queuing for CS domain

- a) This measurement provides the number of RABs failed to release for CS domain in which a queuing process has not been involved. The measurement is split into subcounters per failure cause.
- b) CC.

- c) On transmission by the RNC of a RANAP RAB ASSIGNMENT RESPONSE message for CS domain, each RAB failed to release is added to the relevant measurement according to the failure cause. Possible causes are included in TS 25.413. The sum of all supported per cause measurements shall equal the total number of RAB Release Failures. In case only a subset of per cause measurements is supported, a sum measurement subtype will be provided first.

NOTE: The addition is performed with the condition that the RAB has not been mentioned as queued in a previous RANAP RAB ASSIGNMENT RESPONSE.

- d) Each measurement is an integer value. The number of measurements is equal to the number of causes supported plus a possible sum value identified by the *.sum* suffix.
- e) The measurement name has the form RAB.FailRelCSNoQueuing.*Cause* where *Cause* identifies the failure cause.
- f) RncFunction.
- g) Valid for circuit switched traffic.
- h) UMTS.

#### 4.1.6.4 Successful RAB releases with queuing for CS domain

- a) This measurement provides the number of successfully released RABs for CS domain in which a queuing process has been involved. The measurement is split into subcounters per release cause.
- b) CC.
- c) On transmission by the RNC of a RANAP RAB ASSIGNMENT RESPONSE message for CS domain, each successfully released RAB is added to the relevant measurement according to the release cause. Possible causes are included in TS 25.413. The sum of all supported per cause measurements shall equal the total number of RAB Release Successes. In case only a subset of per cause measurements is supported, a sum measurement subtype will be provided first. See TS 25.413 and TS 23.107.

NOTE: The addition is performed with the condition that the RAB has been mentioned as queued in a previous RANAP RAB ASSIGNMENT RESPONSE.

- d) Each measurement is an integer value. The number of measurements is equal to the number of causes plus a possible sum value identified by the *.sum* suffix.
- e) The measurement name has the form RAB.SuccRelCSQueuing.*Cause* where *Cause* identifies the release cause.
- f) RncFunction.
- g) Valid for circuit switched traffic.
- h) UMTS.

#### 4.1.6.5 Failed RAB releases with queuing for CS domain

- a) This measurement provides the number of RABs failed to release for CS domain in which a queuing process has been involved. The measurement is split into subcounters per failure cause.
- b) CC.
- c) On transmission by the RNC of a RANAP RAB ASSIGNMENT RESPONSE message for CS domain, each RAB failed to release is added to the relevant measurement according to the cause. Possible causes are included in TS 25.413. The sum of all supported per cause measurements shall equal the total number of RAB Release Failures. In case only a subset of per cause measurements is supported, a sum measurement subtype will be provided first.

NOTE: The addition is performed with the condition that the RAB has been mentioned as queued in a previous RANAP RAB ASSIGNMENT RESPONSE.

- d) Each measurement is an integer value. The number of measurements is equal to the number of causes plus a possible sum value identified by the *.sum* suffix.
- e) The measurement name has the form RAB.FailRelCSQueuing.Cause where *Cause* identifies the failure cause.
- f) RncFunction.
- g) Valid for circuit switched traffic.
- h) UMTS.

#### 4.1.7 RAB release request by CN for PS domain

The five measurement types defined in the clause 4.1.3 for PS domain are subject to the "4 out of 5 approach".

##### 4.1.7.1 Attempted RAB releases for PS domain

- a) This measurement provides the number of requested RABs in release attempts for PS domain. The measurement is split into subcounters per release cause.
- b) CC.
- c) On receipt by the RNC of a RANAP RAB ASSIGNMENT REQUEST message for PS domain, each requested RAB in release attempts is added to the relevant measurement according to the release cause. Possible causes are included in TS 25.413. The sum of all supported per cause measurements shall equal the total number of RAB Release Attempts. In case only a subset of per cause measurements is supported, a sum measurement subtype will be provided first. See TS 25.413 and TS 23.107.
- d) Each measurement is an integer value. The number of measurements is equal to the number of causes plus a possible sum value identified by the *.sum* suffix.
- e) The measurement name has the form RAB.AttRelPS.Cause where *Cause* identifies the release cause.
- f) RncFunction.
- g) Valid for packet switched traffic.
- h) UMTS.

##### 4.1.7.2 Successful RAB releases without queuing for PS domain

- a) This measurement provides the number of successfully released RABs for PS domain in which a queuing process has not been involved. The measurement is split into subcounters per release cause.
- b) CC.
- c) On transmission by the RNC of a RANAP RAB ASSIGNMENT RESPONSE message for PS domain, each successfully released RAB is added to the relevant measurement according to the release cause. Possible causes are included in TS 25.413. The sum of all supported per cause measurements shall equal the total number of RAB Release Successes. In case only a subset of per cause measurements is supported, a sum measurement subtype will be provided first. See TS 25.413 and TS 23.107.

NOTE: The addition is performed with the condition that the RAB has not been mentioned as queued in a previous RANAP RAB ASSIGNMENT RESPONSE.

- d) Each measurement is an integer value. The number of measurements is equal to the number of causes plus a possible sum value identified by the *.sum* suffix.
- e) The measurement name has the form RAB.SuccRelPSNoQueuing.Cause where *Cause* identifies the release cause.
- e) RncFunction.

- f) Valid for packet switched traffic.
- g) UMTS.

#### 4.1.7.3 Failed RAB releases without queuing for PS domain

- a) This measurement provides the number of RABs failed to release for PS in which a queuing process has not been involved. The measurement is split into subcounters per failure cause.
- b) CC.
- c) On transmission by the RNC of a RANAP RAB ASSIGNMENT RESPONSE message for PS domain, each RAB failed to release is added to the relevant measurement according to the failure cause. Possible causes are included in TS 25.413. The sum of all supported per cause measurements shall equal the total number of RAB Release Failures. In case only a subset of per cause measurements is supported, a sum measurement subtype will be provided first.

NOTE: The addition is performed with the condition that the RAB has not been mentioned as queued in a previous RANAP RAB ASSIGNMENT RESPONSE.

- d) Each measurement is an integer value. The number of measurements is equal to the number of causes plus a possible sum value identified by the *.sum* suffix.
- e) The measurement name has the form RAB.FailRelPSNoQueuing.*Cause* where *Cause* identifies the failure cause.
- f) RncFunction.
- g) Valid for packet switched traffic.
- h) UMTS.

#### 4.1.7.4 Successful RAB releases with queuing for PS domain

- a) This measurement provides the number of successfully released RABs for PS domain in which a queuing process has been involved. The measurement is split into subcounters per release cause.
- b) CC.
- c) On transmission by the RNC of a RANAP RAB ASSIGNMENT RESPONSE message for PS domain, each successfully released RAB is added to the relevant measurement according to the release cause. Possible causes are included in TS 25.413. The sum of all supported per cause measurements shall equal the total number of RAB Release Successes. In case only a subset of per cause measurements is supported, a sum measurement subtype will be provided first. See TS 25.413 and TS 23.107. See TS 25.413 and TS 23.107.

NOTE: The addition is performed with the condition that the RAB has been mentioned as queued in a previous RANAP RAB ASSIGNMENT RESPONSE.

- d) Each measurement is an integer value. The number of measurements is equal to the number of causes plus a possible sum value identified by the *.sum* suffix.
- e) The measurement name has the form RAB.SuccRelPSQueuing.*Cause* where *Cause* identifies the release cause.
- f) RncFunction.
- g) Valid for packet switched traffic.
- h) UMTS.

#### 4.1.7.5 Failed RAB releases with queuing for PS domain

- a) This measurement provides the number of RABs failed to release for PS domain in which a queuing process has been involved. The measurement is split into subcounters per failure cause.
- b) CC.
- c) On transmission by the RNC of a RANAP RAB ASSIGNMENT RESPONSE message for PS domain, each RAB failed to release is added to the relevant measurement according to the cause. Possible causes are included in TS 25.413. The sum of all supported per cause measurements shall equal the total number of RAB Release Failures. In case only a subset of per cause measurements is supported, a sum measurement subtype will be provided first.
- d) Each measurement is an integer value. The number of measurements is equal to the number of causes plus a possible sum value identified by the *.sum* suffix.
- e) The measurement name has the form RAB.FailRelPSQueuing.*Cause* where *Cause* identifies the failure cause.
- f) RncFunction.
- g) Valid for packet switched traffic.
- h) UMTS.

#### 4.1.8 RAB setup time

##### 4.1.8.1 RAB CS connection set-up time (Mean)

- a) This measurement provides the mean time during each granularity period for a RNC to establish a RAB CS connection.
- b) DER (n=1).
- c) This measurement is obtained by accumulating the time intervals for each successful RAB establishment between the receipt by the RNC of a RANAP "RAB ASSIGNMENT REQUEST" message to establish a RAB for CS domain, and the first corresponding (based on RAB ID) transmission by the RNC of a RANAP "RAB ASSIGNMENT RESPONSE" message for successfully established RABs over a granularity period using DER, see TS 25.413 [5]. This end value of the time will then be divided by the number of successfully established RABs observed in the granularity period to give the arithmetic mean, the accumulator shall be reinitialised at the beginning of each granularity period.
- d) Each measurement is an integer value.(in milliseconds).
- e) RAB.SuccEstabCSSetupTimeMean
- f) RncFunction.
- g) Valid for circuit switched traffic.
- h) UMTS.

##### 4.1.8.2 RAB CS connection set-up time (Maximum)

- a) This measurement provides the maximum time during each granularity period for a RNC to establish a RAB CS connection.
- b) GAUGE.
- c) This measurement is obtained by monitoring the time intervals for each successful RAB establishment between the receipt by the RNC of a RANAP "RAB ASSIGNMENT REQUEST" message to establish a RAB for CS domain, and the first corresponding (based on RAB ID) transmission by the RNC of a RANAP "RAB ASSIGNMENT RESPONSE" message for successfully established RABs see TS 25.413 [5]. The high tide mark of this time will be stored in a gauge, the gauge shall be reinitialised at the beginning of each granularity period.



- d) Each measurement is an integer value.(in milliseconds).
- e) RAB.SuccEstabCSSSetupTimeMax
- f) RncFunction.
- g) Valid for circuit switched traffic.
- h) UMTS.

#### 4.1.8.3 RAB PS connection set-up time (Mean)

- a) This measurement provides the mean time during each granularity period for a RNC to establish a RAB PS connection.
- b) DER (n=1).
- c) This measurement is obtained by accumulating the time intervals for each successful RAB establishment between the receipt by the RNC of a RANAP "RAB ASSIGNMENT REQUEST" message to establish a RAB for PS domain, and the first corresponding (based on RAB ID) transmission by the RNC of a RANAP "RAB ASSIGNMENT RESPONSE" message for successfully established RABs over a granularity period using DER, see TS 25.413 [5]. This end value of the time will then be divided by the number of successfully established RABs observed in the granularity period to give the arithmetic mean, the accumulator shall be reinitialised at the beginning of each granularity period.
- d) Each measurement is an integer value.(in milliseconds).
- e) RAB.SuccEstabPSSetupTimeMean
- f) RncFunction.
- g) Valid for packet switched traffic.
- h) UMTS.

#### 4.1.8.4 RAB PS connection set-up time (Maximum)

- a) This measurement provides the maximum time during each granularity period for a RNC to establish a RAB PS connection.
- b) GAUGE.
- c) This measurement is obtained by monitoring the time intervals for each successful RAB establishment between the receipt by the RNC of a RANAP "RAB ASSIGNMENT REQUEST" message to establish a RAB for PS domain, and the first corresponding (based on RAB ID) transmission by the RNC of a RANAP "RAB ASSIGNMENT RESPONSE" message for successfully established RABs see TS 25.413 [5]. The high tide mark of this time will be stored in a gauge, the gauge shall be reinitialised at the beginning of each granularity period.
- d) Each measurement is an integer value.(in milliseconds).
- e) RAB.SuccEstabPSSetupTimeMax
- f) RncFunction.
- g) Valid for packet switched traffic.
- h) UMTS.

## 4.1.9 RAB release request by UTRAN

### 4.1.9.1 RAB release requests for CS domain

- a) This measurement provides the number of RABs requested to release by UTRAN for CS domain split into subcounters per cause.
- b) CC.
- c) On transmission by the RNC of a RANAP RAB RELEASE REQUEST message for CS domain, each RAB requested to be released is added to the relevant per cause measurement. Possible causes are included in TS 25.413 [5]. The sum of all supported per cause measurements shall equal the total number of RAB Release Requests for the CS domain. In case only a subset of per cause measurements is supported, a sum subcounter will be provided first.
- d) Each measurement is an integer value. The number of measurements is equal to the number of causes plus a possible sum value identified by the *.sum* suffix.
- e) The measurement name has the form RAB.RelReqCS.*Cause* where *Cause* identifies the release cause.
- f) RncFunction.
- g) Valid for circuit switched traffic.
- h) UMTS.

### 4.1.9.2 RAB release requests for PS domain

- a) This measurement provides the number of RABs requested to release by UTRAN for PS domain split into subcounters per cause.
- b) CC.
- c) On transmission by the RNC of a RANAP RAB RELEASE REQUEST message for PS domain, each RAB requested to be released is added to the relevant per cause measurement. Possible causes are included in TS 25.413 [5]. The sum of all supported per cause measurements shall equal the total number of RAB Release Requests for the PS domain. In case only a subset of per cause measurements is supported, a sum subcounter will be provided first.
- d) Each measurement is an integer value. The number of measurements is equal to the number of causes plus a possible sum value identified by the *.sum* suffix.
- e) The measurement name has the form RAB.RelReqPS.*Cause* where *Cause* identifies the release cause.
- f) RncFunction.
- g) Valid for packet switched traffic.
- h) UMTS.

## 4.2 Void

## 4.3 Signalling connection establishment

### 4.3.1 Attempted signalling connection establishments for CS domain

- a) This measurement provides the number of attempts by RNC to establish an Iu control plane connection between the RNC and a CS CN.

NOTE: There is no confirmation in response to this message to indicate that the CN-RNC connection was successfully setup.

- b) CC.
- c) Transmission of a RANAP Initial UE message by the RNC to the CN. This is sent by the RNC on receipt of an RRC Initial Direct Transfer message from the UE.
- d) A single integer value.
- e) SIG.AttConnEstabCS.
- f) RncFunction.
- g) Valid for circuit switching.
- h) UMTS.

### 4.3.2 Attempted signalling connection establishments for PS domain

- a) This measurement provides the number of requests by RNC to establish an Iu control plane connection between the RNC and a PS CN.

NOTE: There is no confirmation in response to this message to indicate that the CN-RNC connection was successfully setup.

- b) CC.
- c) Transmission of a RANAP Initial UE message by the RNC to the CN. This is sent by the RNC on receipt of an RRC Initial Direct Transfer message from the UE.
- d) A single integer value.
- e) SIG.AttConnEstabPS.
- f) RncFunction.
- g) Valid for packet switching.
- h) UMTS.

## 4.4 RRC connection establishment

### 4.4.1 RRC connection establishments

The three measurement types defined in the clause 4.4.1.n are subject to the "2 out of 3 approach".

#### 4.4.1.1 Attempted RRC connection establishments

- a) This measurement provides the number of RRC connection establishment attempts for each establishment cause.
- b) CC.

- c) Receipt of an RRC Connection Request message by the RNC from the UE. Each RRC Connection Request message received is added to the relevant per cause measurement. The possible causes are included in TS 25.331 [4]. The sum of all supported per cause measurements shall equal the total number of RRC Connection Establishment attempts. In case only a subset of per cause measurements is supported, a sum subcounter will be provided first.
- d) Each measurement is an integer value. The number of measurements is equal to the number of causes plus a possible sum value identified by the *.sum* suffix.
- e) The measurement name has the form RRC.AttConnEstab.*Cause* where *Cause* identifies the Establishment Cause.
- f) UtranCell.
- g) Valid for circuit switched and packet switched traffic.
- h) UMTS.

#### 4.4.1.2 Failed RRC connection establishments

- a) This measurement provides the number of RRC establishment failures for each rejection cause.
- b) CC.
- c) Transmission of an RRC Connection Reject message by the RNC to the UE or an expected RRC CONNECTION SETUP COMPLETE message not received by the RNC. Each RRC Connection Reject message received is added to the relevant per cause measurement. The possible causes are included in TS 25.331 [4]. Each expected RRC CONNECTION SETUP COMPLETE not received by the RNC is added to the measurement cause 'No Reply' (not specified in TS 25.331 [4]). The sum of all supported per cause measurements shall equal the total number of RRC Connection Establishment Failures. In case only a subset of per cause measurements is supported, a sum subcounter will be provided first.
- d) Each measurement is an integer value. The number of measurements is equal to the number of causes plus a possible sum value identified by the *.sum* suffix.
- e) The measurement name has the form RRC.FailConnEstab.*Cause* where *Cause* identifies the Rejection Cause. The cause 'No Reply' is identified by the *.NoReply* suffix.
- f) UtranCell.
- g) Valid for circuit switched and packet switched traffic.
- h) UMTS.

#### 4.4.1.3 Successful RRC connection establishments

- a) This measurement provides the number of successful RRC establishments for each establishment cause.
- b) CC.
- c) Receipt by the RNC of a RRC CONNECTION SETUP COMPLETE message following a RRC establishment attempt. Each RRC Connection Setup Complete message received is added to the relevant per cause measurement. The possible causes are included in TS 25.331 [4]. The sum of all supported per cause measurements shall equal the total number of RRC Connection Establishments. In case only a subset of per cause measurements is supported, a sum subcounter will be provided first.
- d) Each measurement is an integer value. The number of measurements is equal to the number of causes plus a possible sum value identified by the *.sum* suffix.
- e) The measurement name has the form RRC.SuccConnEstab.*Cause* where *Cause* identifies the Establishment Cause.
- f) UtranCell.

- g) Valid for circuit switched and packet switched traffic.
- h) UMTS.

## 4.4.2 RRC connection establishment setup time

### 4.4.2.1 RRC connection set-up time (Mean)

- a) This measurement provides the mean time per establishment cause it takes for the RNC to establish a RRC connection during each granularity period. The measurement is split into subcounters per establishment cause.
- b) DER (n=1)
- c) This measurement is obtained by accumulating the time intervals for every successful RRC connection establishment per establishment cause between the receipt by the RNC from the UE of a "RRC CONNECTION REQUEST" and the corresponding "RRC CONNECTION SETUP COMPLETE" message over a granularity period using DER. The end value of this time will then be divided by the number of successful RRC connections observed in the granularity period to give the arithmetic mean, the accumulator shall be reinitialised at the beginning of each granularity period. The measurement is split into subcounters per establishment cause, see TS 25.331 [4].

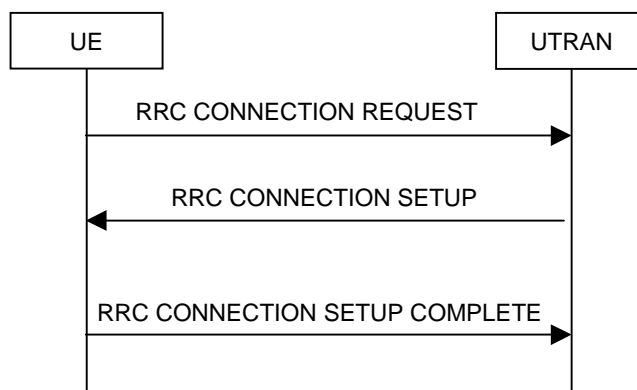

**Figure**

- d) Each measurement is an integer value.(in milliseconds)
- e) RRC.AttConnEstabTimeMean.Cause  
where *Cause* identifies the Establishment Cause.
- f) UtranCell.
- g) Valid for circuit switched and packet switched traffic
- h) UMTS

### 4.4.2.2 RRC connection set-up time (Max)

- a) This measurement provides the maximum time per establishment cause it takes for the RNC in order to establish a RRC connection during each granularity period. The measurement is split into subcounters per establishment cause.
- b) GAUGE
- c) This measurement is obtained by monitoring the time intervals for each successful RRC connection establishment per establishment cause between the receipt by the RNC from the UE of a "RRC CONNECTION REQUEST" and the corresponding "RRC CONNECTION SETUP COMPLETE" message, see TS 25.331 [4]. The high tide mark of this time will be stored in a gauge, the gauge shall be reinitialised at the beginning of each granularity period. The measurement is split into subcounters per establishment cause.

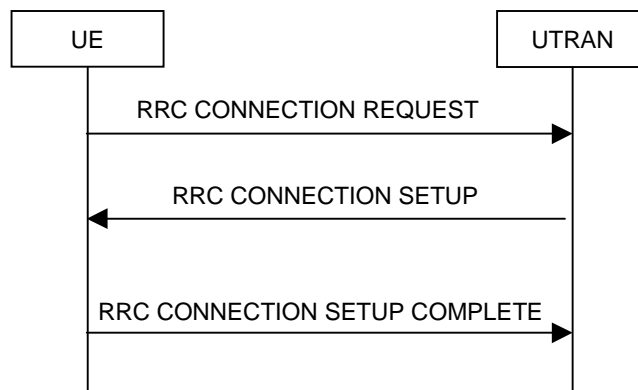

**Figure**

- d) Each measurement is an integer value.(in milliseconds)
- e) RRC.AttConnEstabTimeMax.Cause  
where Cause identifies the Establishment Cause.
- f) UtranCell.
- g) Valid for circuit switched and packet switched traffic
- h) UMTS

## 4.5 RRC connection re-establishment

The three measurement types defined in the subclause 4.5.n are subject to the "2 out of 3 approach".

### 4.5.1 Attempted RRC re-establishments

- a) This measurement provides the number of RRC re-establishments attempts.
- b) CC.
- c) Receipt by the RNC of a CELL UPDATE message using the Cell Update cause "Radio link failure". See TS 25.331 [4].
- d) A single integer value.
- e) RRC.AttConnReEstab.
- f) UtranCell.
- g) Valid for circuit switched and packet switched traffic.
- h) UMTS.

### 4.5.2 Failed RRC re-establishments

- a) This measurement provides the number of RRC re-establishment failures.
- b) CC.

- c) Transmission of an RRC Connection Release message by RNC to the UE or an expected UTRAN Mobility Information Confirm message not received by RNC from the UE. See TS 25.331 [4].  
Each RRC Connection Release message received is added to the relevant per cause measurement. The possible causes are included in TS 25.331 [4].  
Each expected UTRAN Mobility Information Confirm message not received by the RNC is added to the measurement cause 'No Reply' (not specified in TS 25.331 [4]).  
The sum of all supported per cause measurements shall equal the total number of RRC re-establishment failures. In case only a subset of per cause measurements is supported, a sum subcounter will be provided first.
- d) Each measurement is an integer value. The number of measurements is equal to the number of causes plus a possible sum value identified by the *.sum* suffix.
- e) The measurement name has the form RRC.FailConnReEstab.*Cause* where *Cause* identifies the Failure Cause.  
The cause 'No Reply' is identified by the *.NoReply* suffix.
- f) UtranCell.
- g) Valid for circuit switched and packet switched traffic.
- h) UMTS.

### 4.5.3 Successful RRC re-establishments

- a) This measurement provides the number of successful RRC re-establishments.
- b) CC.
- c) Receipt by the RNC of a UTRAN MOBILITY INFORMATION CONFIRM in a CELL UPDATE procedure using the value cause "Radio link failure". See TS 25.331 [4].
- d) A single integer value.
- e) RRC.SuccConnReEstab.
- f) UtranCell.
- g) Valid for circuit switched and packet switched traffic.
- h) UMTS.

## 4.6 RRC connection release

### 4.6.1 Attempted RRC connection releases on DCCH

- a) This measurement provides the number of RRC connection release attempts per release cause sent from UTRAN to the UE on the DCCH.
- b) CC.
- c) Transmission of an RRC CONNECTION RELEASE message by the RNC to the UE on DCCH. Each RRC Connection Release message sent on DCCH is added to the relevant per cause measurement. The possible causes are included in TS 25.331 [4]. The sum of all supported per cause measurements shall equal the total number of RRC Connection Release attempts on DCCH. In case only a subset of per cause measurements is supported, a sum subcounter will be provided first.
- d) Each measurement is an integer value. The number of measurements is equal to the number of causes plus a possible sum value identified by the *.sum* suffix.
- e) The measurement name has the form RRC.AttConnRelDCCH.*Cause* where *Cause* identifies the Release Cause.
- f) UtranCell.

- g) Valid for circuit switched and packet switched traffic.
- h) UMTS.

## 4.6.2 Attempted RRC connection releases on CCCH

- a) This measurement provides the number of RRC connection release attempts per release cause sent from UTRAN to the UE on the CCCH.
- b) CC.
- c) Transmission by the RNC of an RRC CONNECTION RELEASE message to the UE on CCCH. Each RRC Connection Release message sent on CCCH is added to the relevant per cause measurement. The possible causes are included in TS 25.331 [4]. The sum of all supported per cause measurements shall equal the total number of RRC Connection Release attempts on CCCH. In case only a subset of per cause measurements is supported, a sum subcounter will be provided first.
- d) Each measurement is an integer value. The number of measurements is equal to the number of causes plus a possible sum value identified by the *.sum* suffix.
- e) The measurement name has the form RRC.AttConnRelCCCH.Cause where *Cause* identifies the Release Cause.
- f) UtranCell.
- g) Valid for circuit switched and packet switched traffic.
- h) UMTS.

## 4.7 RLC connection

### 4.7.1 Number of RLC blocks sent (per Mode)

- a) This measurement provides the number of RLC blocks sent by the RNC including retransmitted blocks.
- b) CC.
- c) Transmission of RLC block, see TS 25.322 [24].
- d) RLC.NbrBlocksSent.TM  
RLC.NbrBlocksSent.UM  
RLC.NbrBlocksSent.AM
- e) A single integer value.
- f) RncFunction, per Mode (Transparent, Unacknowledged and Acknowledged).
- g) Valid for packet switching and circuit switching.
- h) UMTS.

### 4.7.2 Number of RLC blocks Received (per Mode)

- a) This measurement provides the number of received RLC blocks by the RNC.
- b) CC.
- c) Receipt of a RLC blocks from a peer entity and before any error checking, see TS 25.322 [24].
- d) RLC.NbrBlocksReceived.TM  
RLC.NbrBlocksReceived.UM  
RLC.NbrBlocksReceived.AM



- e) A single integer value.
- f) RncFunction per Mode (Transparent, Unacknowledged and Acknowledged).
- g) Valid for packet switching and circuit switching.
- h) UMTS.

### 4.7.3 Discarded RLC blocks by RNC

- a) This measurement provides the number of discarded RLC blocks in case of error detection in the RNC (uplink transmission, RNC).
- b) CC.
- c) Discard of a received block in the RNC, see TS 25.322 [24].
- d) RLC.DiscardedBlocksByRNC.
- e) A single integer value.
- f) RncFunction.
- g) Valid for packet switching.
- h) UMTS.

### 4.7.4 Number of Retransmitted RLC blocks in Acknowledge Mode

- a) This measurement provides the number of retransmitted RLC blocks in RLC acknowledge mode, detected in the UE and signalled to the RNC (downlink transmission, UE).
- b) CC.
- c) Receipt of a NACK or SACK block from the peer entity (UE) , see TS 25.322 [24].
- d) RLC.RetransmittedBlocksToUE.
- e) A single integer value.
- f) RncFunction.
- g) Valid for packet switching.
- h) UMTS

## 4.8 Soft handover

### 4.8.1 Radio link additions to active link set (UE side)

The three measurement types defined in the subclause 4.8.1.n for the radio link additions to active link set (UE side) are subject to the "2 out of 3 approach".

#### 4.8.1.1 Attempted radio link additions to active link set (UE side)

- a) This measurement provides the number of attempted radio link additions during active link set update procedure (UE side) for each cell. This measurement shall be increased for each attempted radio link addition (UE side). This measurement is only valid for FDD mode.
- b) CC.

- c) Transmission of an ACTIVE SET UPDATE message (RRC) by the serving RNC to the UE. Within an ACTIVE SET UPDATE message more than one radio link can be added. Each existing radio link addition information element shall be considered separately (see TS 25.331 [4]).
- d) A single integer value.
- e) SHO.AttRLAddUESide.
- f) UtranCell.
- g) Valid for circuit switched and packet switched traffic.
- h) UMTS.

#### 4.8.1.2 Successful radio link additions to active link set (UE side)

- a) This measurement provides the number of successful radio link additions during active link set update procedure (UE side) for each cell. This measurement shall be increased for each successful radio link addition (UE side). This measurement is only valid for FDD mode.
- b) CC.
- c) Receipt of an ACTIVE SET UPDATE COMPLETE message (RRC), sent by the UE to the SERVING RNC, in response to an ACTIVE SET UPDATE message with one or more existing radio link addition information element. One ACTIVE SET UPDATE COMPLETE message can be related to more than one added radio link. Each successful added radio link shall be considered separately (see TS 25.331 [4]).
- d) A single integer value.
- e) SHO.SuccRLAddUESide.
- f) UtranCell.
- g) Valid for circuit switched and packet switched traffic.
- h) UMTS.

#### 4.8.1.3 Failed radio link additions to active link set (UE side)

- a) This measurement provides the number of failed radio link additions during active link set Update procedure (UE side) for each cell per cause. For each failure cause a separate subcounter is defined. Every failed radio link addition (UE side) shall be considered separately. This measurement is only valid for FDD mode.
- b) CC.
- c) Receipt of an ACTIVE SET UPDATE FAILURE message (RRC) sent by UE to the UTRAN in response to an ACTIVE SET UPDATE message with non-empty radio link addition information element or an expected ACTIVE SET UPDATE COMPLETE message not received by the RNC. Each message can be related to more than one radio link.
  - Each failed attempt to add a radio link shall be considered separately and added to the relevant per cause measurement. Failure causes are defined within TS 25.331 [4].
  - Each expected ACTIVE SET UPDATE COMPLETE message not received by the RNC is added to the measurement cause 'No Reply' (not specified in TS 25.331 [4]).
  - The sum of all supported per cause measurements shall equal the total number of failures. In case only a subset of per cause measurements is supported, a sum subcounter will be provided first.
- d) Each measurement is an integer value. The number of measurements is equal to the number of causes supported plus a possible sum value identified by the *.sum* suffix.
- e) The measurement name has the form SHO.FailRLAddUESide.*Cause* where *Cause* identifies the failure cause. The cause 'No Reply' is identified by the *.NoReply* suffix.

- f) UtranCell.
- g) Valid for circuit switched and packet switched traffic.
- h) UMTS.

## 4.8.2 Radio link deletions from active link set (UE side)

### 4.8.2.1 Attempted radio link deletions from active link set (UE side)

- a) This measurement provides the number of attempted radio link deletions during active link set update procedure (UE side) for each cell. This measurement shall be increased for each attempted radio link deletion (UE side). This measurement is only valid for FDD mode.
- b) CC.
- c) Transmission of an ACTIVE SET UPDATE message (RRC) by the SERVING RNC to the UE. Within an ACTIVE SET UPDATE message more than one radio link can be removed. Each existing radio link removal information element shall be considered separately (see TS 25.331 [4]).
- d) A single integer value.
- e) SHO.AttRLDelUESide.
- f) UtranCell.
- g) Valid for circuit switched and packet switched traffic.
- h) UMTS.

### 4.8.2.2 Successful radio link deletions from active link set (UE side)

- a) This measurement provides the number of successful radio link deletions during active link set update procedure (UE side) for each cell. This measurement shall be increased for each successful radio link deletion (UE side). This measurement is only valid for FDD mode.
- b) CC.
- c) Receipt of an ACTIVE SET UPDATE COMPLETE message (RRC) sent by UE to the Serving RNC in response to an ACTIVE SET UPDATE message with one or more existing radio link removal information element. One ACTIVE SET UPDATE COMPLETE message can be related to more than one deleted radio link. Each successful deleted radio link shall be considered separately (see TS 25.331 [4]).
- d) A single integer value.
- e) SHO.SuccRLDelUESide.
- f) UtranCell.
- g) Valid for circuit switched and packet switched traffic.
- h) UMTS.

## 4.9 Radio link management procedures

### 4.9.1 Overview

#### 4.9.1.1 Considered radio link management procedures

Performance Measurement definitions in subclause 4.9 are based on the TS 25.423 "UTRAN Iur interface RNSAP Signalling" [6] and TS 25.433 "UTRAN Iub Interface NBAP signalling" [7].

The following paragraphs are of interest for this purpose:

- Radio Link Setup (NBAP);
- Radio Link Addition (NBAP);
- Radio Link Deletion (NBAP);
- Radio Link Setup (RNSAP);
- Radio Link Addition (RNSAP);
- Radio Link Deletion (RNSAP);
- RADIO LINK SETUP REQUEST (NBAP);
- RADIO LINK SETUP RESPONSE (NBAP);
- RADIO LINK SETUP FAILURE (NBAP);
- RADIO LINK ADDITION REQUEST (NBAP);
- RADIO LINK ADDITION RESPONSE (NBAP);
- RADIO LINK ADDITION FAILURE (NBAP);
- RADIO LINK DELETION REQUEST (NBAP);
- RADIO LINK DELETION RESPONSE (NBAP);
- RADIO LINK SETUP REQUEST (RNSAP);
- RADIO LINK SETUP RESPONSE (RNSAP);
- RADIO LINK SETUP FAILURE (RNSAP);
- RADIO LINK ADDITION REQUEST (RNSAP);
- RADIO LINK ADDITION RESPONSE (RNSAP);
- RADIO LINK ADDITION FAILURE (RNSAP);
- RADIO LINK DELETION REQUEST (RNSAP);
- RADIO LINK DELETION RESPONSE (RNSAP).

These paragraphs show in particular the following diagrams:

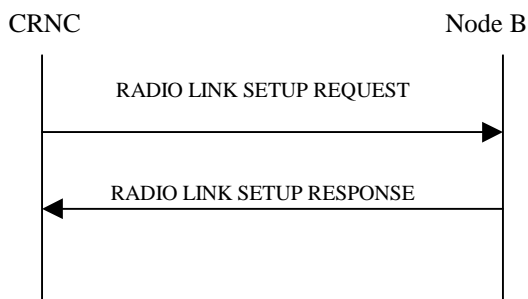

**Figure: Radio Link Setup procedure on lub, Successful Operation**

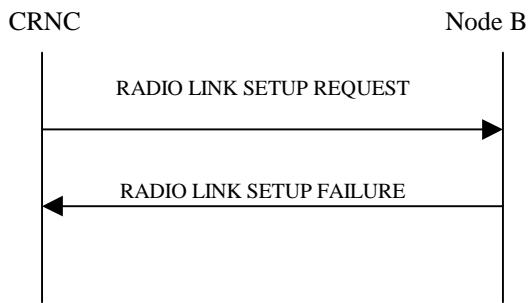

Figure: Radio Link Setup procedure on Iub, Unsuccessful Operation

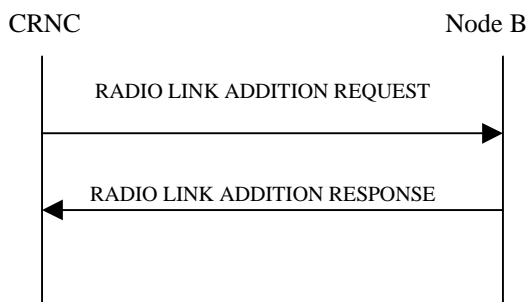

Figure: Radio Link Addition procedure on Iub, Successful Operation

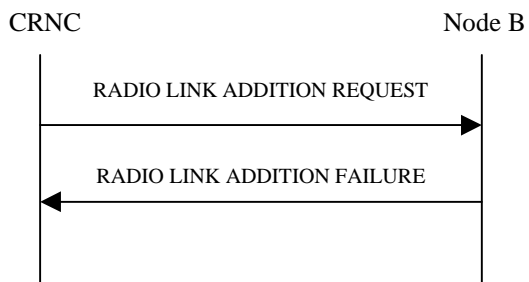

Figure: Radio Link Addition procedure on Iub, Unsuccessful Operation

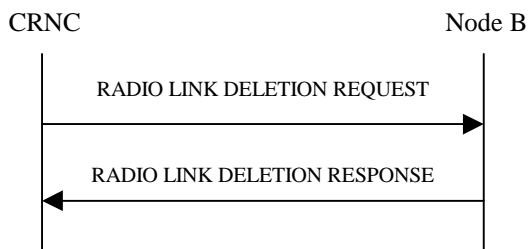

Figure: Radio Link Deletion procedure on Iub, Successful Operation

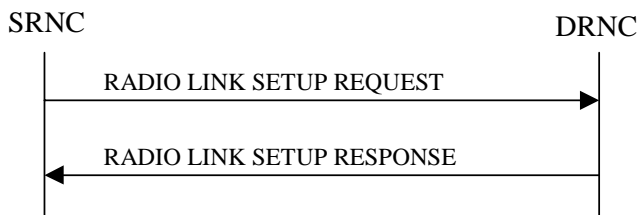
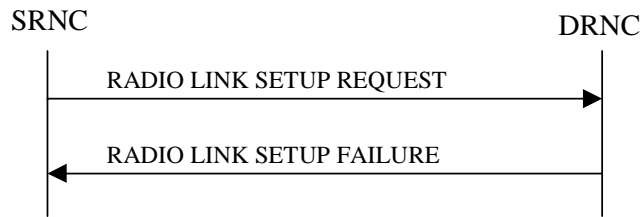
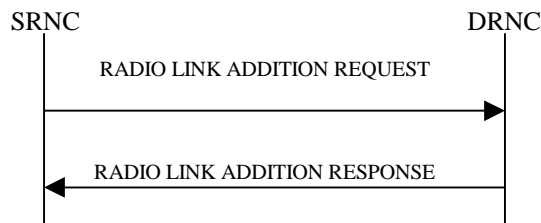

Figure: Radio Link Setup procedure on Iur, Successful Operation



**Figure: Radio Link Setup procedure on Iur, Unsuccessful Operation**



**Figure: Radio Link Addition procedure on Iur, Successful Operation**

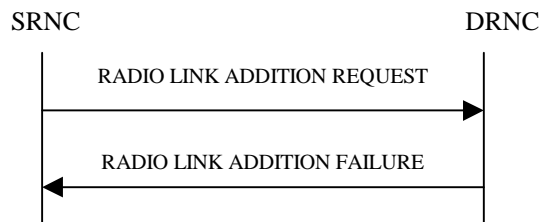

**Figure: Radio Link Addition procedure on Iur, Unsuccessful Operation**

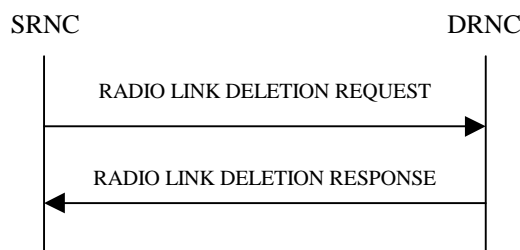

**Figure: Radio Link Deletion procedure on Iur, Successful Operation**

#### 4.9.1.2 Relation between Iub measurements and Iur measurements

The following figure shows the relation between Iub interface and Iur interface. There are two cases for SRNC (CRNC1) to request radio link management activities in this figure.

In case (1), SRNC (CRNC1) sets up/adds/deletes radio links in NodeB1 and NodeB1 is directly controlled by SRNC (CRNC1).

In case (2/2bis), NodeB2 is directly controlled by DRNC (CRNC2). If SRNC (CRNC1) wants to set up/add/delete radio links in NodeB2, SRNC (CRNC1) will send request to DRNC (CRNC2), and DRNC (CRNC2) set up/add/delete radio links in NodeB2. In such case, if DRNC (CRNC2) fails to set up/add radio links in NodeB2 and receives failure message from NodeB2, DRNC (CRNC2) will send failure message back to SRNC (CRNC1). Furthermore if DRNC (CRNC2) has problem inside and fails to send request to NodeB2, it will send failure message back to the SRNC (CRNC1) directly.

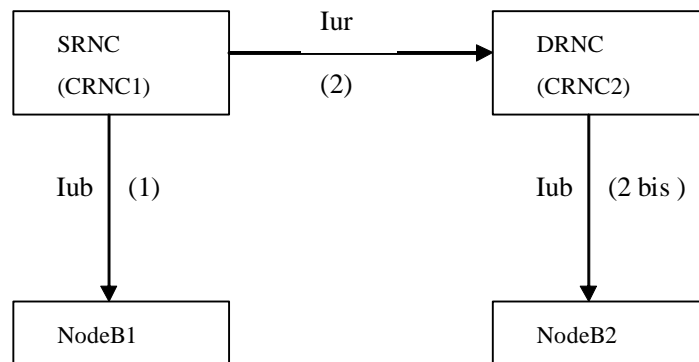

**Figure: Relation between Iub interface and Iur interface**

Subclause 4.9 has separated measurements for both Iur interface and Iub interface. From the above figure and description, we can see that the Iub interface measurements and Iur interface measurements overlap in some degree. Based on maintenance requirements, these two kinds measurements are needed and they are useful for operators to evaluate both the Iub interface and Iur interface, and to analyze all the failure cases they concern.

## 4.9.2 Radio link setups on Iub

The three measurement types defined in the subclauses 4.9.2.n for radio link setups on Iub are subject to the "2 out of 3 approach".

### 4.9.2.1 Attempted radio link setups on Iub

- a) This measurement provides the number of attempted radio link setups on Iub for each cell. This measurement shall be increased for each attempted radio link setup on Iub. This measurement is valid for FDD and TDD mode.
- b) CC.
- c) Transmission of a RADIO LINK SETUP REQUEST message (NBAP) by the controlling RNC to the NodeB. Within a RADIO LINK SETUP REQUEST message more than one radio link can be set up. Each existing radio link information element shall be considered separately (see TS 25.433 [7]).
- d) A single integer value.
- e) RLM.AttRLSetupIub.
- f) UtranCell.
- g) Valid for circuit switched and packet switched traffic.
- h) UMTS.

### 4.9.2.2 Successful radio link setups on Iub

- a) This measurement provides the number of successful radio link setups on Iub for each cell. This measurement shall be increased for each successful radio link setup on Iub. This measurement is valid for FDD and TDD mode.
- b) CC.
- c) This measurement is based on two different events:
  - Receipt of a RADIO LINK SETUP RESPONSE message (NBAP) sent by NodeB to the controlling RNC in response to a RADIO LINK SETUP REQUEST message with one or more existing radio link information

elements. One RADIO LINK SETUP RESPONSE message can be related to more than one radio link. Each radio link that is set up successfully shall be considered separately (see TS 25.433 [7]).

- Receipt of a RADIO LINK SETUP FAILURE message (NBAP) sent by NodeB to the controlling RNC in response to a RADIO LINK SETUP REQUEST message with at least one Successful RL Information Response information element. One RADIO LINK SETUP FAILURE message can be related to more than one radio link. Each radio link that is set up successfully shall be considered separately (see TS 25.433 [7]).
- d) A single integer value.
- e) RLM.SuccRLSetupIub.
- f) UtranCell.
- g) Valid for circuit switched and packet switched traffic.
- h) UMTS.

#### 4.9.2.3 Failed radio link setups on Iub

- a) This measurement provides the number of failed radio link setups on Iub for each cell. This measurement shall be increased for each failed radio link setup on Iub. For each failure cause a separate measurement is defined. Every failed radio link setup on Iub shall be considered separately. This measurement is valid for FDD and TDD mode.
- b) CC.
- c) Receipt of a RADIO LINK SETUP FAILURE message (NBAP) sent by NodeB to the controlling RNC in response to a RADIO LINK SETUP REQUEST message with one or more existing radio link information elements. One RADIO LINK SETUP FAILURE message can be related to more than one radio link. Each failed attempt to set up a radio link shall be considered separately. Failure causes are defined within TS 25.433 [7].

Each expected RADIO LINK SETUP RESPONSE or RADIO LINK SETUP FAILURE not received by the controlling RNC is added to the measurement cause 'No Reply' (not specified in TS 25.433 [7]).

The sum of all supported per cause measurements shall equal the total number of failures. In case only a subset of per cause measurements is supported, a sum measurement subtype will be provided first.

- d) Each measurement is an integer value. The number of measurements is equal to the number of causes supported plus a possible sum value identified by the *.sum* suffix.
- e) The measurement name has the form RLM.FailRLSetupIub.*Cause* where *Cause* identifies the failure cause.
- f) UtranCell.
- g) Valid for circuit switched and packet switched traffic.
- h) UMTS.

### 4.9.3 Radio link setups on Iur

The three measurement types defined in the subclauses 4.9.3.n for radio link setups on Iur are subject to the "2 out of 3 approach".

#### 4.9.3.1 Attempted radio link setups on Iur

- a) This measurement provides the number of attempted radio link setups on Iur for each cell. This measurement shall be increased for each attempted radio link setup on Iur. This measurement is valid for FDD and TDD mode.
- b) CC.



- c) Receipt of a RADIO LINK SETUP REQUEST message (RNSAP) sent by the serving RNC to the drift RNC. Within a RADIO LINK SETUP REQUEST message more than one radio link can be set up. Each existing radio link information element shall be considered separately (see TS 25.423 [6]).
- d) A single integer value.
- e) RLM.AttRLSetupIur.
- f) UtranCell.
- g) Valid for circuit switched and packet switched traffic.
- h) UMTS.

#### 4.9.3.2 Successful radio link setups on Iur

- a) This measurement provides the number of successful radio link setups on Iur for each cell. This measurement shall be increased for each successful radio link setup on Iur. This measurement is valid for FDD and TDD mode.
- b) CC.
- c) This measurement is based on two different events:
  - Transmission of a RADIO LINK SETUP RESPONSE message (RNSAP) by the drift RNC to the serving RNC in response to a RADIO LINK SETUP REQUEST message with one or more existing radio link information elements. One RADIO LINK SETUP RESPONSE message can be related to more than one radio link. Each radio link that is set up successfully shall be considered separately (see TS 25.423 [6]).
  - Transmission of a RADIO LINK SETUP FAILURE message (RNSAP) by the drift RNC to the serving RNC in response to a RADIO LINK SETUP REQUEST message with at least one Successful RL Information Response information element. One RADIO LINK SETUP FAILURE message can be related to more than one radio link. Each radio link that is set up successfully shall be considered separately (see TS 25.423 [6]).
- d) A single integer value.
- e) RLM.SuccRLSetupIur.
- f) UtranCell.
- g) Valid for circuit switched and packet switched traffic.
- h) UMTS.

#### 4.9.3.3 Failed radio link setups on Iur

- a) This measurement provides the number of failed radio link setups on Iur for each cell. This measurement shall be increased for each failed radio link setup on Iur. For each failure cause a separate measurement is defined. Every failed radio link setup on Iur shall be considered separately. This measurement is valid for FDD and TDD mode.
- b) CC.
- c) Transmission of a RADIO LINK SETUP FAILURE message (RNSAP) by the drift RNC to the serving RNC in response to a RADIO LINK SETUP REQUEST message with one or more existing radio link information elements. One RADIO LINK SETUP FAILURE message can be related to more than one radio link. Each failed attempt to set up a radio link shall be considered separately. Failure causes are defined within TS 25.423 [6].
 

The sum of all supported per cause measurements shall equal the total number of failures. In case only a subset of per cause measurements is supported, a sum measurement subtype will be provided first.
- d) Each measurement is an integer value. The number of measurements is equal to the number of causes supported plus a possible sum value identified by the *.sum* suffix.
- e) The measurement name has the form RLM.FailRLSetupIur.*Cause* where *Cause* identifies the failure cause.

- f) UtranCell.
- g) Valid for circuit switched and packet switched traffic.
- h) UMTS.

#### 4.9.4 Radio link additions on Iub

The three measurement types defined in the subclauses 4.9.4.n for radio link additions on Iub are subject to the "2 out of 3 approach".

##### 4.9.4.1 Attempted radio link additions on Iub

- a) This measurement provides the number of attempted radio link additions on Iub for each cell. This measurement shall be increased for each attempted radio link addition on Iub. This measurement is valid for FDD and TDD mode.
- b) CC.
- c) Transmission of a RADIO LINK ADDITION REQUEST message (NBAP) by the controlling RNC to the NodeB. Within a RADIO LINK ADDITION REQUEST message more than one radio link can be added. Each existing radio link information element shall be considered separately (see TS 25.433 [7]).
- d) A single integer value.
- e) RLM.AttRLAddIub.
- f) UtranCell.
- g) Valid for circuit switched and packet switched traffic.
- h) UMTS.

##### 4.9.4.2 Successful radio link additions on Iub

- a) This measurement provides the number of successful radio link additions on Iub for each cell. This measurement shall be increased for each successful radio link addition on Iub. This measurement is valid for FDD and TDD mode.
- b) CC.
- c) This measurement is based on two different events:
  - Receipt of a RADIO LINK ADDITION RESPONSE message (NBAP) sent by NodeB to the controlling RNC in response to a RADIO LINK ADDITION REQUEST message with one or more existing radio link information elements. One RADIO LINK ADDITION RESPONSE message can be related to more than one added radio link. Each successful added radio link shall be considered separately (see TS 25.433 [7]).
  - Receipt of a RADIO LINK ADDITION FAILURE message (NBAP) sent by NodeB to the controlling RNC in response to a RADIO LINK ADDITION REQUEST message with at least one Successful RL Information Response information element. One RADIO LINK ADDITION FAILURE message can be related to more than one radio link. Each successful added radio link shall be considered separately (see TS 25.433 [7]).
- d) A single integer value.
- e) RLM.SuccRLAddIub.
- f) UtranCell.
- g) Valid for circuit switched and packet switched traffic.
- h) UMTS.

#### 4.9.4.3 Failed radio link additions on Iub

- a) This measurement provides the number of failed radio link additions on Iub for each cell. This measurement shall be increased for each failed radio link addition on Iub. For each failure cause a separate measurement is defined. Every failed radio link addition on Iub shall be considered separately. This measurement is valid for FDD and TDD mode.
- b) CC.
- c) Receipt of a RADIO LINK ADDITION FAILURE message (NBAP) sent by NodeB to the controlling RNC in response to a RADIO LINK ADDITION REQUEST message with one or more existing radio link information elements. One RADIO LINK ADDITION FAILURE message can be related to more than one radio link. Each failed attempt to add a radio link shall be considered separately. Failure causes are defined within TS 25.433 [7].

Each expected RADIO LINK ADDITION RESPONSE or RADIO LINK ADDITION FAILURE not received by the controlling RNC is added to the measurement cause 'No Reply' (not specified in TS 25.433 [7]).

The sum of all supported per cause measurements shall equal the total number of failures. In case only a subset of per cause measurements is supported, a sum measurement subtype will be provided first.

- d) Each measurement is an integer value. The number of measurements is equal to the number of causes supported plus a possible sum value identified by the *.sum* suffix.
- e) The measurement name has the form RLM.FailRLAddIub.*Cause* where *Cause* identifies the failure cause.
- f) UtranCell.
- g) Valid for circuit switched and packet switched traffic.
- h) UMTS.

#### 4.9.5 Radio link additions on Iur

The three measurement types defined in the subclauses 4.9.5.n for radio link additions on Iur are subject to the "2 out of 3 approach".

##### 4.9.5.1 Attempted radio link additions on Iur

- a) This measurement provides the number of attempted radio link additions on Iur for each cell. This measurement shall be increased for each attempted radio link addition on Iur. This measurement is valid for FDD and TDD mode.
- b) CC.
- c) Receipt of a RADIO LINK ADDITION REQUEST message (RNSAP) sent by the serving RNC to the drift RNC. Within a RADIO LINK ADDITION REQUEST message more than one radio link can be added. Each existing radio link information element shall be considered separately (see TS 25.423 [6]).
- d) A single integer value.
- e) RLM.AttRLAddIur.
- f) UtranCell.
- g) Valid for circuit switched and packet switched traffic.
- h) UMTS.

##### 4.9.5.2 Successful radio link additions on Iur

- a) This measurement provides the number of successful radio link additions on Iur for each cell. This measurement shall be increased for each successful radio link addition on Iur. This measurement is valid for FDD and TDD mode.

- b) CC.
- c) This measurement is based on two different events:
  - Transmission of a RADIO LINK ADDITION RESPONSE message (RNSAP) by the drift RNC to the serving RNC in response to a RADIO LINK ADDITION REQUEST message with one or more existing radio link information elements. One RADIO LINK ADDITION RESPONSE message can be related to more than one added radio link. Each successful added radio link shall be considered separately (see TS 25.423 [6]).
  - Transmission of a RADIO LINK ADDITION FAILURE message (RNSAP) by the drift RNC to the serving RNC in response to a RADIO LINK ADDITION REQUEST message with at least one Successful RL Information Response information element. One RADIO LINK ADDITION FAILURE message can be related to more than one radio link. Each successful added radio link shall be considered separately (see TS 25.423 [6]).
- d) A single integer value.
- e) RLM.SuccRLAddIur.
- f) UtranCell.
- g) Valid for circuit switched and packet switched traffic.
- h) UMTS.

#### 4.9.5.3 Failed radio link additions on Iur

- a) This measurement provides the number of failed radio link additions on Iur for each cell. This measurement shall be increased for each failed radio link addition on Iur. For each failure cause a separate measurement is defined. Every failed radio link addition shall be considered separately. This measurement is valid for FDD and TDD mode.
- b) CC.
- c) Transmission of a RADIO LINK ADDITION FAILURE message (RNSAP) by the drift RNC to the serving RNC in response to a RADIO LINK ADDITION REQUEST message with one or more existing radio link information elements. One RADIO LINK ADDITION FAILURE message can be related to more than one radio link. Each failed attempt to add a radio link shall be considered separately. Failure causes are defined within TS 25.423 [6].

The sum of all supported per cause measurements shall equal the total number of Failures. In case only a subset of per cause measurements is supported, a sum measurement subtype will be provided first.

- d) Each measurement is an integer value. The number of measurements is equal to the number of causes supported plus a possible sum value identified by the *.sum* suffix.
- e) The measurement name has the form RLM.FailRLAddIur.*Cause* where *Cause* identifies the failure cause.
- f) UtranCell.
- g) Valid for circuit switched and packet switched traffic.
- h) UMTS.

#### 4.9.6 Radio link deletions on Iub

##### 4.9.6.1 Attempted radio link deletions on Iub

- a) This measurement provides the number of attempted radio link deletions on Iub for each cell. This measurement shall be increased for each attempted radio link deletion on Iub. This measurement is valid for FDD and TDD mode.

- b) CC.
- c) Transmission of a RADIO LINK DELETION REQUEST message (NBAP) by the controlling RNC to the NodeB. Within a RADIO LINK DELETION REQUEST message more than one radio link can be removed. Each existing radio link information element shall be considered separately (see TS 25.433 [7]).
- d) A single integer value.
- e) RLM.AttRLDelIub.
- f) UtranCell.
- g) Valid for circuit switched and packet switched traffic.
- h) UMTS.

#### 4.9.6.2 Successful radio link deletions on Iub

- a) This measurement provides the number of successful radio link deletions on Iub for each cell. This measurement shall be increased for each successful radio link deletion on Iub. This measurement is valid for FDD and TDD mode.
- b) CC.
- c) Receipt of a RADIO LINK DELETION RESPONSE message (NBAP) sent by NodeB to the controlling RNC in response to a RADIO LINK DELETION REQUEST message with one or more existing radio link removal information element. One RADIO LINK DELETION RESPONSE message can be related to more than one deleted radio link. Each successful deleted radio link shall be considered separately (see TS 25.433 [7]).
- d) A single integer value.
- e) RLM.SuccRLDelIub.
- f) UtranCell.
- g) Valid for circuit switched and packet switched traffic.
- h) UMTS

#### 4.9.7 Radio link deletions on Iur

##### 4.9.7.1 Attempted radio link deletions on Iur

- a) This measurement provides the number of attempted radio link deletions on Iur for each cell. This measurement shall be increased for each attempted radio link deletion on Iur. This measurement is valid for FDD and TDD mode.
- b) CC.
- c) Receipt of a RADIO LINK DELETION REQUEST message (RNSAP) sent by the serving RNC to the drift RNC. Within a RADIO LINK DELETION REQUEST message more than one radio link can be removed. Each existing radio link information element shall be considered separately (see TS 25.423 [6]).
- d) A single integer value.
- e) RLM.AttRLDelIur.
- f) UtranCell.
- g) Valid for circuit switched and packet switched traffic.
- h) UMTS.

#### 4.9.7.2 Successful radio link deletions on Iur

- a) This measurement provides the number of successful radio link deletions on Iur for each cell. This measurement shall be increased for each successful radio link deletion on Iur. This measurement is valid for FDD and TDD mode.
- b) CC.
- c) Transmission of a RADIO LINK DELETION RESPONSE message (RNSAP) by the drift RNC to the serving RNC in response to a RADIO LINK DELETION REQUEST message with one or more existing radio link removal information element. One RADIO LINK DELETION RESPONSE message can be related to more than one deleted radio link. Each successful deleted radio link shall be considered separately (see TS 25.423 [6]).
- d) A single integer value.
- e) RLM.SuccRLDelIur.
- f) UtranCell.
- g) Valid for circuit switched and packet switched traffic.
- h) UMTS.

### 4.10 Hard handover

#### 4.10.1 Void

#### 4.10.2 Outgoing intra-NodeB hard handovers

The three measurement types defined in the subclause 4.10.2.n for outgoing intra-NodeB hard handovers are subject to the "2 out of 3 approach".

##### 4.10.2.1 Attempted outgoing intra-NodeB hard handovers

- a) This measurement provides the number of attempted outgoing intra-NodeB hard handovers per neighbour cell relation.
- b) CC.
- c) Transmission of a RRC message PHYSICAL CHANNEL RECONFIGURATION, RADIO BEARER SETUP, RADIO BEARER RECONFIGURATION, RADIO BEARER RELEASE, or TRANSPORT CHANNEL RECONFIGURATION from the source RNC to the UE, indicating the attempt of an outgoing intra-NodeB hard handover (see TS 25.331 [4]).
- d) A single integer value.
- e) HHO.AttOutIntraNodeB.
- f) UtranRelation.
- g) Valid for circuit switched and packet switched traffic.
- h) UMTS.

##### 4.10.2.2 Successful outgoing intra-NodeB hard handovers

- a) This measurement provides the number of successful outgoing intra-NodeB hard handovers per neighbour cell relation.
- b) CC.

- c) Receipt of a RRC message PHYSICAL CHANNEL RECONFIGURATION COMPLETE, RADIO BEARER SETUP COMPLETE, RADIO BEARER RECONFIGURATION COMPLETE, RADIO BEARER RELEASE COMPLETE, or TRANSPORT CHANNEL RECONFIGURATION COMPLETE sent from the UE to the source RNC, indicating a successful outgoing intra-NodeB hard handover (see TS 25.331 [4]).
- d) A single integer value.
- e) HHO.SuccOutIntraNodeB.
- f) UtranRelation.
- g) Valid for circuit switched and packet switched traffic.
- h) UMTS.

#### 4.10.2.3 Failed outgoing intra-NodeB hard handovers

- a) This measurement provides the number of failed outgoing intra-NodeB hard handovers per neighbour cell relation per cause.
- b) CC.
- c) Receipt of a RRC message PHYSICAL CHANNEL RECONFIGURATION FAILURE, RADIO BEARER SETUP FAILURE, RADIO BEARER RECONFIGURATION FAILURE, RADIO BEARER RELEASE FAILURE, or TRANSPORT CHANNEL RECONFIGURATION FAILURE sent from the UE to the source RNC, indicating a failed outgoing intra-NodeB hard handover. Failure causes are defined within TS 25.331 [4].

Each expected RRC message PHYSICAL CHANNEL RECONFIGURATION COMPLETE, RADIO BEARER SETUP COMPLETE, RADIO BEARER RECONFIGURATION COMPLETE, RADIO BEARER RELEASE COMPLETE, TRANSPORT CHANNEL RECONFIGURATION COMPLETE, PHYSICAL CHANNEL RECONFIGURATION FAILURE, RADIO BEARER SETUP FAILURE, RADIO BEARER RECONFIGURATION FAILURE, RADIO BEARER RELEASE FAILURE, or TRANSPORT CHANNEL RECONFIGURATION FAILURE not received by the source RNC is added to the measurement cause 'No Reply' (not specified in TS 25.331 [4]).

The sum of all supported per cause measurements shall equal the total number of failed events. In case only a subset of per cause measurements is supported, a sum subcounter will be provided first.

- d) Each measurement is an integer value. The number of measurements is equal to the number of causes supported plus a possible sum value identified by the *.sum* suffix.
- e) The measurement name has the form HHO.FailOutIntraNodeB.*Cause* where *Cause* identifies the failure cause. The cause 'No Reply' is identified by the *.NoReply* suffix.
- f) UtranRelation.
- g) Valid for circuit switched and packet switched traffic.
- h) UMTS.

#### 4.10.3 Outgoing inter-NodeB, intra-RNC hard handovers

The three measurement types defined in the subclause 4.10.3.n for outgoing inter-NodeB, intra-RNC hard handovers are subject to the "2 out of 3 approach".

##### 4.10.3.1 Attempted outgoing inter-NodeB, intra-RNC hard handovers

- a) This measurement provides the number of attempted outgoing inter-NodeB, intra-RNC hard handovers per neighbour cell relation.
- b) CC.

- c) Transmission of a RRC message PHYSICAL CHANNEL RECONFIGURATION, RADIO BEARER SETUP, RADIO BEARER RECONFIGURATION, RADIO BEARER RELEASE, or TRANSPORT CHANNEL RECONFIGURATION from the source RNC to the UE, indicating the attempt of an outgoing inter-NodeB, intra-RNC hard handover (see TS 25.331 [4]).
- d) A single integer value.
- e) HHO.AttOutInterNodeBIntraRNC.
- f) UtranRelation.
- g) Valid for circuit switched and packet switched traffic.
- h) UMTS.

#### 4.10.3.2 Successful outgoing inter-NodeB, intra-RNC hard handovers

- a) This measurement provides the number of successful outgoing inter-NodeB, intra-RNC hard handovers per neighbour cell relation.
- b) CC.
- c) Receipt of a RRC message PHYSICAL CHANNEL RECONFIGURATION COMPLETE, RADIO BEARER SETUP COMPLETE, RADIO BEARER RECONFIGURATION COMPLETE, RADIO BEARER RELEASE COMPLETE, or TRANSPORT CHANNEL RECONFIGURATION COMPLETE sent from the UE to the source RNC, indicating a successful outgoing inter-NodeB, intra-RNC hard handover (see TS 25.331 [4]).
- d) A single integer value.
- e) HHO.SuccOutInterNodeBIntraRNC.
- f) UtranRelation.
- g) Valid for circuit switched and packet switched traffic.
- h) UMTS.

#### 4.10.3.3 Failed outgoing inter-NodeB, intra-RNC hard handovers

- a) This measurement provides the number of failed outgoing inter-NodeB, intra-RNC hard handovers per neighbour cell relation per cause.
- b) CC.
- c) Receipt of a RRC message PHYSICAL CHANNEL RECONFIGURATION FAILURE, RADIO BEARER SETUP FAILURE, RADIO BEARER RECONFIGURATION FAILURE, RADIO BEARER RELEASE FAILURE, or TRANSPORT CHANNEL RECONFIGURATION FAILURE sent from the UE to the source RNC, indicating a failed outgoing inter-NodeB, intra-RNC hard handover. Failure causes are defined within TS 25.331 [4].

Each expected RRC message PHYSICAL CHANNEL RECONFIGURATION COMPLETE, RADIO BEARER SETUP COMPLETE, RADIO BEARER RECONFIGURATION COMPLETE, RADIO BEARER RELEASE COMPLETE, TRANSPORT CHANNEL RECONFIGURATION COMPLETE, PHYSICAL CHANNEL RECONFIGURATION FAILURE, RADIO BEARER SETUP FAILURE, RADIO BEARER RECONFIGURATION FAILURE, RADIO BEARER RELEASE FAILURE, or TRANSPORT CHANNEL RECONFIGURATION FAILURE not received by the source RNC is added to the measurement cause 'No Reply' (not specified in TS 25.331 [4]).

The sum of all supported per cause measurements shall equal the total number of failed events. In case only a subset of per cause measurements is supported, a sum subcounter will be provided first.

- d) Each measurement is an integer value. The number of measurements is equal to the number of causes supported plus a possible sum value identified by the *.sum* suffix.



- e) The measurement name has the form `HHO.FailOutInterNodeBIntraRNC.Cause` where *Cause* identifies the failure cause. The cause 'No Reply' is identified by the *NoReply* suffix.
- f) `UtranRelation`.
- g) Valid for circuit switched and packet switched traffic.
- h) UMTS.

#### 4.10.4 Outgoing inter-RNC hard handovers via Iur

The three measurement types defined in the subclause 4.10.4.n for outgoing inter-RNC hard handovers are subject to the "2 out of 3 approach".

##### 4.10.4.1 Attempted outgoing inter-RNC hard handovers via Iur

- a) This measurement provides the number of attempted outgoing inter-RNC hard handovers via Iur per neighbour cell relation.
- b) CC.
- c) Transmission of a RRC message `PHYSICAL CHANNEL RECONFIGURATION`, `RADIO BEARER SETUP`, `RADIO BEARER RECONFIGURATION`, `RADIO BEARER RELEASE`, or `TRANSPORT CHANNEL RECONFIGURATION` from the source RNC to the UE, indicating the attempt of an outgoing inter-RNC hard handover via Iur (see TS 25.331 [4]).
- d) A single integer value.
- e) `HHO.AttOutInterRNCIur`.
- f) `UtranRelation`.
- g) Valid for circuit switched and packet switched traffic.
- h) UMTS.

##### 4.10.4.2 Successful outgoing inter-RNC hard handovers via Iur

- a) This measurement provides the number of successful outgoing inter-RNC hard handovers via Iur per neighbour cell relation.
- b) CC.
- c) Receipt of a RRC message `PHYSICAL CHANNEL RECONFIGURATION COMPLETE`, `RADIO BEARER SETUP COMPLETE`, `RADIO BEARER RECONFIGURATION COMPLETE`, `RADIO BEARER RELEASE COMPLETE`, or `TRANSPORT CHANNEL RECONFIGURATION COMPLETE` sent from the UE to the source RNC, indicating a successful outgoing inter-RNC hard handover via Iur (see TS 25.331 [4]).
- d) A single integer value.
- e) `HHO.SuccOutInterRNCIur`.
- f) `UtranRelation`.
- g) Valid for circuit switched and packet switched traffic.
- h) UMTS.

#### 4.10.4.3 Failed outgoing inter-RNC hard handovers via Iur

- a) This measurement provides the number of failed outgoing inter-RNC hard handovers via Iur per neighbour cell relation per cause.
- b) CC.
- c) Receipt of a RRC message PHYSICAL CHANNEL RECONFIGURATION FAILURE, RADIO BEARER SETUP FAILURE, RADIO BEARER RECONFIGURATION FAILURE, RADIO BEARER RELEASE FAILURE, or TRANSPORT CHANNEL RECONFIGURATION FAILURE sent from the UE to the source RNC, indicating a failed outgoing inter-RNC hard handover via Iur. Failure causes are defined within TS 25.331 [4].

Each expected RRC message PHYSICAL CHANNEL RECONFIGURATION COMPLETE, RADIO BEARER SETUP COMPLETE, RADIO BEARER RECONFIGURATION COMPLETE, RADIO BEARER RELEASE COMPLETE, TRANSPORT CHANNEL RECONFIGURATION COMPLETE, PHYSICAL CHANNEL RECONFIGURATION FAILURE, RADIO BEARER SETUP FAILURE, RADIO BEARER RECONFIGURATION FAILURE, RADIO BEARER RELEASE FAILURE, or TRANSPORT CHANNEL RECONFIGURATION FAILURE not received by the source RNC is added to the measurement cause 'No Reply' (not specified in TS 25.331 [4]).

The sum of all supported per cause measurements shall equal the total number of failed events. In case only a subset of per cause measurements is supported, a sum subcounter will be provided first.

- d) Each measurement is an integer value. The number of measurements is equal to the number of causes supported plus a possible sum value identified by the *.sum* suffix.
- e) The measurement name has the form HHO.FailOutInterRNCIur.Cause where *Cause* identifies the failure cause. The cause 'No Reply' is identified by the *.NoReply* suffix.
- f) UtranRelation.
- g) Valid for circuit switched and packet switched traffic.

#### 4.10.5 Relocation preparation for outgoing inter-RNC hard handovers switching in the CN

The three measurement types defined in the subclause 4.10.5.n for relocation preparation for outgoing inter-RNC hard handovers switching in the CN are subject to the "2 out of 3 approach".

##### 4.10.5.1 Attempted relocation preparation for outgoing inter-RNC hard handovers switching in the CN

- a) This measurement provides the number of attempted relocation preparation for outgoing inter-RNC hard handovers switching in the CN per neighbour cell relation.
- b) CC.
- c) Transmission of a RANAP message RELOCATION REQUIRED from the source RNC to the CN (Source side), indicating an attempted relocation preparation of a outgoing inter-RNC hard handover switching in the CN (see TS 25.413 [5]).
- d) A single integer value.
- e) HHO.AttRelocPrepOutInterRNCCN.
- f) UtranRelation.
- g) Valid for circuit switched and packet switched traffic.
- h) UMTS.

#### 4.10.5.2 Successful relocation preparation for outgoing inter-RNC hard handovers switching in the CN

- a) This measurement provides the number of successful relocation for outgoing inter-RNC hard handovers switching in the CN per neighbour cell relation.
- b) CC.
- c) Receipt of a RANAP message RELOCATION COMMAND sent from the CN (Source side) to the source RNC, indicating a successful relocation preparation of a outgoing inter-RNC hard handover switching in the CN (see TS 25.413 [5]).
- d) A single integer value.
- e) HHO.SuccAttRelocPrepOutInterRNCCN.
- f) UtranRelation.
- g) Valid for circuit switched and packet switched traffic.
- h) UMTS.

#### 4.10.5.3 Failed relocation preparation for outgoing inter-RNC hard handovers switching in the CN

- a) This measurement provides number of failed relocation for outgoing inter-RNC hard handovers switching in the CN per neighbour cell relation per cause.
- b) CC.
- c) Receipt of a RANAP message RELOCATION PREPARATION FAILURE sent from the CN (Source side) to the source RNC, indicating a failed relocation preparation for outgoing inter-RNC hard handover switching in the CN. Failure causes are defined within TS 25.413 [5]. The sum of all supported per cause measurements shall equal the total number of failed events. In case only a subset of per cause measurements is supported, a sum subcounter will be provided first.
- d) Each measurement is an integer value. The number of measurements is equal to the number of causes supported plus a possible sum value identified by the *.sum* suffix.
- e) The measurement name has the form HHO.FailRelocPrepOutInterRNCCN.*Cause* where *Cause* identifies the name of the failure cause.
- f) UtranRelation.
- g) Valid for circuit switched and packet switched traffic.
- h) UMTS.

#### 4.10.6 Outgoing inter-RNC hard handovers switching in the CN

The three measurement types defined in the subclause 4.10.6.n for outgoing inter-RNC hard handovers switching in the CN are subject to the "2 out of 3 approach".

##### 4.10.6.1 Attempted outgoing inter-RNC hard handovers switching in the CN

- a) This measurement provides the number of attempted outgoing inter-RNC hard handovers switching in the CN per neighbour cell relation related to UEs.
- b) CC.
- c) Transmission of a RRC message PHYSICAL CHANNEL RECONFIGURATION, RADIO BEARER SETUP, RADIO BEARER RECONFIGURATION, RADIO BEARER RELEASE, or TRANSPORT CHANNEL RECONFIGURATION from the source RNC to the UE, indicating the attempt of an inter-RNC hard handover switching in the CN (see TS 25.331 [4]).

- d) A single integer value.
- e) HHO.AttOutInterRNCCN.
- f) UtranRelation.
- g) Valid for circuit switched and packet switched traffic.
- h) UMTS.

#### 4.10.6.2 Successful outgoing inter-RNC hard handovers switching in the CN

- a) This measurement provides the number of successful outgoing inter-RNC hard handovers switching in the CN per neighbour cell relation related to UEs.
- b) CC.
- c) Receipt of a RANAP message Iu RELEASE COMMAND sent from the CN (Source side) to the source RNC, indicating a successful inter-RNC hard handover switching in the CN (see TS 25.413 [5]).
- d) A single integer value.
- e) HHO.SuccOutInterRNCCN.
- f) UtranRelation.
- g) Valid for circuit switched and packet switched traffic.
- h) UMTS.

#### 4.10.6.3 Failed outgoing inter-RNC hard handovers switching in the CN

- a) This measurement provides the number of failed outgoing inter-RNC hard handovers switching in the CN per neighbour cell relation related to UEs.
- b) CC.
- c) Receipt of a RRC message PHYSICAL CHANNEL RECONFIGURATION FAILURE, RADIO BEARER SETUP FAILURE, RADIO BEARER RECONFIGURATION FAILURE, RADIO BEARER RELEASE FAILURE, or TRANSPORT CHANNEL RECONFIGURATION FAILURE sent from the UE to the source RNC, indicating a failed inter-RNC hard handover switching in the CN. Failure causes are defined within TS 25.331 [4].

Each expected RRC message PHYSICAL CHANNEL RECONFIGURATION COMPLETE, RADIO BEARER SETUP COMPLETE, RADIO BEARER RECONFIGURATION COMPLETE, RADIO BEARER RELEASE COMPLETE, TRANSPORT CHANNEL RECONFIGURATION COMPLETE, PHYSICAL CHANNEL RECONFIGURATION FAILURE, RADIO BEARER SETUP FAILURE, RADIO BEARER RECONFIGURATION FAILURE, RADIO BEARER RELEASE FAILURE, or TRANSPORT CHANNEL RECONFIGURATION FAILURE not received by the source RNC is added to the measurement cause 'No Reply' (not specified in TS 25.331 [4]).

The sum of all supported per cause measurements shall equal the total number of failed events. In case only a subset of per cause measurements is supported, a sum subcounter will be provided first.

- d) Each measurement is an integer value. The number of measurements is equal to the number of causes supported plus a possible sum value identified by the *.sum* suffix.
- e) The measurement name has the form HHO.FailOutInterRNCCN.*Cause* where *Cause* identifies the failure cause. The cause 'No Reply' is identified by the *.NoReply* suffix.
- f) UtranRelation.
- g) Valid for circuit switched and packet switched traffic.

- h) UMTS.

## 4.11 Relocation

### 4.11.1 Relocations for CS domain

#### 4.11.1.1 Relocation preparations with UE involved for CS domain

The three measurement types defined in the subclause 4.11.1.1.n for relocation preparations with UE involved for CS domain are subject to the "2 out of 3 approach".

##### 4.11.1.1.1 Attempted relocation preparations with UE involved for CS domain

- a) This measurement provides the number of attempted relocation preparations with UE involved for CS domain.
- b) CC.
- c) Transmission of a RANAP message RELOCATION REQUIRED from the source RNC to the CS CN (Source side) with Relocation Type set to "UE involved in relocation of SRNS", indicating an attempted relocation preparation with UE involved for CS domain (see TS 25.413 [5]).
- d) A single integer value.
- e) RELOC.AttPrepUEInvolCS.
- f) RncFunction.
- g) Valid for circuit switched traffic.
- h) UMTS.

##### 4.11.1.1.2 Successful relocation preparations with UE involved for CS domain

- a) This measurement provides the number of successful relocation preparations with UE involved for CS domain.
- b) CC.
- c) Receipt of a RANAP message RELOCATION COMMAND sent from the CS CN (Source side) to the source RNC, in response to a RELOCATION REQUIRED message with Relocation Type set to "UE involved in relocation of SRNS", indicating a successful relocation preparation with UE involved for CS domain (see TS 25.413 [5]).
- d) A single integer value.
- e) RELOC.SuccPrepUEInvolCS.
- f) RncFunction.
- g) Valid for circuit switched traffic.
- h) UMTS.

##### 4.11.1.1.3 Failed relocation preparations with UE involved for CS domain

- a) This measurement provides the number of failed relocation preparations with UE involved for CS domain per cause.
- b) CC.

- c) Receipt of a RANAP message RELOCATION PREPARATION FAILURE sent from the CS CN (Source side) to the source RNC, in response to a RELOCATION REQUIRED message with Relocation Type set to "UE involved in relocation of SRNS", indicating a failed relocation preparation with UE involved for CS domain. Failure causes are defined within TS 25.413 [5].

Each expected RANAP message RELOCATION COMMAND or RELOCATION PREPARATION FAILURE not received by the source RNC is added to the measurement cause 'No Reply' (not specified in TS 25.413 [5]).

The sum of all supported per cause measurements shall equal the total number of failed events. In case only a subset of per cause measurements is supported, a sum subcounter will be provided first.

- d) Each measurement is an integer value. The number of measurements is equal to the number of causes supported plus a possible sum value identified by the *.sum* suffix.
- e) The measurement name has the form RELOC.FailPrepUEInvolCS.*Cause* where *Cause* identifies the failure cause.
- f) RncFunction.
- g) Valid for circuit switched traffic.
- h) UMTS.

#### 4.11.1.2 Relocation preparations with UE not involved for CS domain

The three measurement types defined in the subclause 4.11.1.2.n for relocation preparations with UE not involved for CS domain are subject to the "2 out of 3 approach".

##### 4.11.1.2.1 Attempted relocation preparations with UE not involved for CS domain

- a) This measurement provides the number of attempted relocation preparations with UE not involved for CS domain.
- b) CC.
- c) Transmission of a RANAP message RELOCATION REQUIRED from the source RNC to the CS CN (Source side) with Relocation Type set to "UE not involved in relocation of SRNS", indicating an attempted relocation preparation with UE not involved for CS domain (see TS 25.413 [5]).
- d) A single integer value.
- e) RELOC.AttPrepUENotInvolCS.
- f) RncFunction.
- g) Valid for circuit switched traffic.
- h) UMTS.

##### 4.11.1.2.2 Successful relocation preparations with UE not involved for CS domain

- a) This measurement provides the number of successful relocation preparations with UE not involved for CS domain.
- b) CC.
- c) Receipt of a RANAP message RELOCATION COMMAND sent from the CS CN (Source side) to the source RNC, in response to a RELOCATION REQUIRED message with Relocation Type set to "UE not involved in relocation of SRNS", indicating a successful relocation preparation with UE not involved for CS domain (see TS 25.413 [5]).
- d) A single integer value.
- e) RELOC.SuccPrepUENotInvolCS.

- f) RncFunction.
- g) Valid for circuit switched traffic.
- h) UMTS.

#### 4.11.1.2.3 Failed relocation preparations with UE not involved for CS domain

- a) This measurement provides the number of failed relocation preparations with UE not involved for CS domain per cause.
- b) CC.
- c) Receipt of a RANAP message RELOCATION PREPARATION FAILURE sent from the CS CN (Source side) to the source RNC, in response to a RELOCATION REQUIRED message with Relocation Type set to "UE not involved in relocation of SRNS", indicating a failed relocation preparation with UE not involved for CS domain. Failure causes are defined within TS 25.413 [5].

Each expected RANAP message RELOCATION COMMAND or RELOCATION PREPARATION FAILURE not received by the source RNC is added to the measurement cause 'No Reply' (not specified in TS 25.413 [5]).

The sum of all supported per cause measurements shall equal the total number of failed events. In case only a subset of per cause measurements is supported, a sum subcounter will be provided first.

- d) Each measurement is an integer value. The number of measurements is equal to the number of causes supported plus a possible sum value identified by the *.sum* suffix.
- e) The measurement name has the form RELOC.FailPrepUENotInvolCS.*Cause* where *Cause* identifies the failure cause.
- f) RncFunction.
- g) Valid for circuit switched traffic.
- h) UMTS.

#### 4.11.1.3 Relocation resource allocations with UE involved for CS domain

The three measurement types defined in the subclause 4.11.1.3.n for relocation resource allocations with UE involved for CS domain are subject to the "2 out of 3 approach".

##### 4.11.1.3.1 Attempted relocations resource allocations with UE involved for CS domain

- a) This measurement provides the number of attempted relocation resource allocations with UE involved for CS domain.
- b) CC.
- c) Receipt of a RANAP message RELOCATION REQUEST sent from the CS CN (Target side) to the target RNC with Relocation Type set to "UE involved in relocation of SRNS", indicating an attempted relocation resource allocation with UE involved for CS domain (see TS 25.413 [5]).
- d) A single integer value.
- e) RELOC.AttResAllocUEInvolCS.
- f) RncFunction.
- g) Valid for circuit switched traffic.
- h) UMTS.

#### 4.11.1.3.2 Successful relocation resource allocations with UE involved for CS domain

- a) This measurement provides the number of successful relocation resource allocations with UE involved for CS domain.
- b) CC.
- c) Transmission of a RANAP message RELOCATION REQUEST ACKNOWLEDGE from the target RNC to the CS CN (Target side), in response to a RELOCATION REQUEST message with Relocation Type set to "UE involved in relocation of SRNS", indicating a successful relocation resource allocation with UE involved for CS domain (see TS 25.413 [5]).
- d) A single integer value.
- e) RELOC.SuccResAllocUEInvolCS.
- f) RncFunction.
- g) Valid for circuit switched traffic.
- h) UMTS.

#### 4.11.1.3.3 Failed relocation resource allocations with UE involved for CS domain

- a) This measurement provides the number of failed relocation resource allocations with UE involved for CS domain per cause.
- b) CC.
- c) Transmission of a RANAP message RELOCATION FAILURE from the target RNC to the CS CN (Target side), in response to a RELOCATION REQUEST message with Relocation Type set to "UE involved in relocation of SRNS", indicating a failed relocation resource allocation with UE involved for CS domain. Failure causes are defined within TS 25.413 [5].

The sum of all supported per cause measurements shall equal the total number of failed events. In case only a subset of per cause measurements is supported, a sum subcounter will be provided first.

- d) Each measurement is an integer value. The number of measurements is equal to the number of causes supported plus a possible sum value identified by the *.sum* suffix.
- e) The measurement name has the form RELOC.FailResAllocUEInvolCS.*Cause* where *Cause* identifies the failure cause.
- f) RncFunction.
- g) Valid for circuit switched traffic.
- h) UMTS.

#### 4.11.1.4 Relocation resource allocations with UE not involved for CS domain

The three measurement types defined in the subclause 4.11.1.4.n for relocation resource allocations with UE not involved for CS domain are subject to the "2 out of 3 approach".

##### 4.11.1.4.1 Attempted relocations resource allocations with UE not involved for CS domain

- a) This measurement provides the number of attempted relocation resource allocations with UE not involved for CS domain.
- b) CC.
- c) Receipt of a RANAP message RELOCATION REQUEST sent from the CS CN (Target side) to the target RNC with Relocation Type set to "UE not involved in relocation of SRNS", indicating an attempted relocation resource allocation with UE not involved for CS domain (see TS 25.413 [5]).



- d) A single integer value.
- e) RELOC.AttResAllocUENotInvolCS.
- f) RncFunction.
- g) Valid for circuit switched traffic.
- h) UMTS.

#### 4.11.1.4.2 Successful relocation resource allocations with UE not involved for CS domain

- a) This measurement provides the number of successful relocation resource allocations with UE not involved for CS domain.
- b) CC.
- c) Transmission of a RANAP message RELOCATION REQUEST ACKNOWLEDGE from the target RNC to the CS CN (Target side), in response to a RELOCATION REQUEST message with Relocation Type set to "UE not involved in relocation of SRNS", indicating a successful relocation resource allocation with UE not involved for CS domain (see TS 25.413 [5]).
- d) A single integer value.
- e) RELOC.SuccResAllocUENotInvolCS.
- f) RncFunction.
- g) Valid for circuit switched traffic.
- h) UMTS.

#### 4.11.1.4.3 Failed relocation resource allocations with UE not involved for CS domain

- a) This measurement provides the number of failed relocation resource allocations with UE not involved for CS domain per cause.
- b) CC.
- c) Transmission of a RANAP message RELOCATION FAILURE from the target RNC to the CS CN (Target side), in response to a RELOCATION REQUEST message with Relocation Type set to "UE not involved in relocation of SRNS", indicating a failed relocation resource allocation with UE not involved for CS domain. Failure causes are defined within TS 25.413 [5].

The sum of all supported per cause measurements shall equal the total number of failed events. In case only a subset of per cause measurements is supported, a sum subcounter will be provided first.

- d) Each measurement is an integer value. The number of measurements is equal to the number of causes supported plus a possible sum value identified by the *.sum* suffix.
- e) The measurement name has the form RELOC.FailResAllocUENotInvolCS.*Cause* where *Cause* identifies the failure cause.
- f) RncFunction.
- g) Valid for circuit switched traffic.
- h) UMTS.

#### 4.11.1.5 Relocations for CS domain

##### 4.11.1.5.1 Successful relocations for CS domain

- a) This measurement provides the number of successful relocations for CS domain ('UE involved' and 'UE not involved' Relocations).
- b) CC.
- c) Receipt of a RANAP message Iu RELEASE COMMAND sent from the CS CN (Source side) to the source RNC in response to a RELOCATION REQUIRED message, indicating a successful relocation for CS domain (see TS 25.413 [5]).
- d) A single integer value.
- e) RELOC.SuccCS.
- f) RncFunction.
- g) Valid for circuit switched traffic.
- h) UMTS.

#### 4.11.2 Relocations for PS domain

##### 4.11.2.1 Relocation preparations with UE involved for PS domain

The three measurement types defined in the subclause 4.11.2.1.n for relocation preparations with UE involved for PS domain are subject to the "2 out of 3 approach".

###### 4.11.2.1.1 Attempted relocation preparations with UE involved for PS domain

- a) This measurement provides the number of attempted relocation preparations with UE involved for PS domain.
- b) CC.
- c) Transmission of a RANAP message RELOCATION REQUIRED from the source RNC to the PS CN (Source side) with Relocation Type set to "UE involved in relocation of SRNS", indicating an attempted relocation preparation with UE involved for PS domain (see TS 25.413 [5]).
- d) A single integer value.
- e) RELOC.AttPrepUEInvolPS.
- f) RncFunction.
- g) Valid for packet switched traffic.
- h) UMTS.

###### 4.11.2.1.2 Successful relocation preparations with UE involved for PS domain

- a) This measurement provides the number of successful relocation preparations with UE involved for PS domain.
- b) CC.
- c) Receipt of a RANAP message RELOCATION COMMAND sent from the PS CN (Source side) to the source RNC, in response to a RELOCATION REQUIRED message with Relocation Type set to "UE involved in relocation of SRNS", indicating a successful relocation preparation with UE involved for PS domain (see TS 25.413 [5]).
- d) A single integer value.
- e) RELOC.SuccPrepUEInvolPS.

- f) RncFunction.
- g) Valid for packet switched traffic.
- h) UMTS.

#### 4.11.2.1.3 Failed relocation preparations with UE involved for PS domain

- a) This measurement provides the number of failed relocation preparations with UE involved for PS domain per cause.
- b) CC.
- c) Receipt of a RANAP message RELOCATION PREPARATION FAILURE sent from the PS CN (Source side) to the source RNC, in response to a RELOCATION REQUIRED message with Relocation Type set to "UE involved in relocation of SRNS", indicating a failed relocation preparation with UE involved for PS domain. Failure causes are defined within TS 25.413 [5].

Each expected RANAP message RELOCATION COMMAND or RELOCATION PREPARATION FAILURE not received by the source RNC is added to the measurement cause 'No Reply' (not specified in TS 25.413 [5]).

The sum of all supported per cause measurements shall equal the total number of failed events. In case only a subset of per cause measurements is supported, a sum subcounter will be provided first.

- d) Each measurement is an integer value. The number of measurements is equal to the number of causes supported plus a possible sum value identified by the *.sum* suffix.
- e) The measurement name has the form RELOC.FailPrepUEInvolPS.*Cause* where *Cause* identifies the failure cause.
- f) RncFunction.
- g) Valid for packet switched traffic.
- h) UMTS.

#### 4.11.2.2 Relocation preparations with UE not involved for PS domain

The three measurement types defined in the subclause 4.11.2.2.n for relocation preparations with UE not involved for PS domain are subject to the "2 out of 3 approach".

##### 4.11.2.2.1 Attempted relocation preparations with UE not involved for PS domain

- a) This measurement provides the number of attempted relocation preparations with UE not involved for PS domain.
- b) CC.
- c) Transmission of a RANAP message RELOCATION REQUIRED from the source RNC to the PS CN (Source side) with Relocation Type set to "UE not involved in relocation of SRNS", indicating an attempted relocation preparation with UE not involved for PS domain (see TS 25.413 [5]).
- d) A single integer value.
- e) RELOC.AttPrepUENotInvolPS.
- f) RncFunction.
- g) Valid for packet switched traffic.
- h) UMTS.

#### 4.11.2.2.2 Successful relocation preparations with UE not involved for PS domain

- a) This measurement provides the number of successful relocation preparations with UE not involved for PS domain.
- b) CC.
- c) Receipt of a RANAP message RELOCATION COMMAND sent from the PS CN (Source side) to the source RNC, in response to a RELOCATION REQUIRED message with Relocation Type set to "UE not involved in relocation of SRNS", indicating a successful relocation preparation with UE not involved for PS domain (see TS 25.413 [5]).
- d) A single integer value.
- e) RELOC.SuccPrepUENotInvolPS.
- f) RncFunction.
- g) Valid for packet switched traffic.
- h) UMTS.

#### 4.11.2.2.3 Failed relocation preparations with UE not involved for PS domain

- a) This measurement provides the number of failed relocation preparations with UE not involved for PS domain per cause.
- b) CC.
- c) Receipt of a RANAP message RELOCATION PREPARATION FAILURE sent from the PS CN (Source side) to the source RNC, in response to a RELOCATION REQUIRED message with Relocation Type set to "UE not involved in relocation of SRNS", indicating a failed relocation preparation with UE not involved for PS domain. Failure causes are defined within TS 25.413 [5].

Each expected RANAP message RELOCATION COMMAND or RELOCATION PREPARATION FAILURE not received by the source RNC is added to the measurement cause 'No Reply' (not specified in TS 25.413 [5]).

The sum of all supported per cause measurements shall equal the total number of failed events. In case only a subset of per cause measurements is supported, a sum subcounter will be provided first.

- d) Each measurement is an integer value. The number of measurements is equal to the number of causes supported plus a possible sum value identified by the *.sum* suffix.
- e) The measurement name has the form RELOC.FailPrepUENotInvolPS.*Cause* where *Cause* identifies the failure cause.
- f) RncFunction.
- g) Valid for packet switched traffic.
- h) UMTS.

#### 4.11.2.3 Relocation resource allocations with UE involved for PS domain

The three measurement types defined in the subclause 4.11.2.3.n for relocation resource allocations with UE involved for PS domain are subject to the "2 out of 3 approach".

##### 4.11.2.3.1 Attempted relocations resource allocations with UE involved for PS domain

- a) This measurement provides the number of attempted relocation resource allocations with UE involved for PS domain.
- b) CC.

- c) Receipt of a RANAP message RELOCATION REQUEST sent from the PS CN (Target side) to the target RNC with Relocation Type set to "UE involved in relocation of SRNS", indicating an attempted relocation resource allocation with UE involved for PS domain (see TS 25.413 [5]).
- d) A single integer value.
- e) RELOC.AttResAllocUEInvolPS.
- f) RncFunction.
- g) Valid for packet switched traffic.
- h) UMTS.

#### 4.11.2.3.2 Successful relocation resource allocations with UE involved for PS domain

- a) This measurement provides the number of successful relocation resource allocations with UE involved for PS domain.
- b) CC.
- c) Transmission of a RANAP message RELOCATION REQUEST ACKNOWLEDGE from the target RNC to the PS CN (Target side), in response to a RELOCATION REQUEST message with Relocation Type set to "UE involved in relocation of SRNS", indicating a successful relocation resource allocation with UE involved for PS domain (see TS 25.413 [5]).
- d) A single integer value.
- e) RELOC.SuccResAllocUEInvolPS.
- f) RncFunction.
- g) Valid for packet switched traffic.
- h) UMTS.

#### 4.11.2.3.3 Failed relocation resource allocations with UE involved for PS domain

- a) This measurement provides the number of failed relocation resource allocations with UE involved for PS domain per cause.
- b) CC.
- c) Transmission of a RANAP message RELOCATION FAILURE from the target RNC to the PS CN (Target side), in response to a RELOCATION REQUEST message with Relocation Type set to "UE involved in relocation of SRNS", indicating a failed relocation resource allocation with UE involved for PS domain. Failure causes are defined within TS 25.413 [5].

The sum of all supported per cause measurements shall equal the total number of failed events. In case only a subset of per cause measurements is supported, a sum subcounter will be provided first.

- d) Each measurement is an integer value. The number of measurements is equal to the number of causes supported plus a possible sum value identified by the *.sum* suffix.
- e) The measurement name has the form RELOC.FailResAllocUEInvolPS.*Cause* where *Cause* identifies the failure cause.
- f) RncFunction.
- g) Valid for packet switched traffic.
- h) UMTS.

#### 4.11.2.4 Relocation resource allocations with UE not involved for PS domain

The three measurement types defined in the subclause 4.11.2.4.n for relocation resource allocations with UE not involved for PS domain are subject to the "2 out of 3 approach".

##### 4.11.2.4.1 Attempted relocations resource allocations with UE not involved for PS domain

- a) This measurement provides the number of attempted relocation resource allocations with UE not involved for PS domain.
- b) CC.
- c) Receipt of a RANAP message RELOCATION REQUEST sent from the PS CN (Target side) to the target RNC with Relocation Type set to "UE not involved in relocation of SRNS", indicating an attempted relocation resource allocation with UE not involved for PS domain (see TS 25.413 [5]).
- d) A single integer value.
- e) RELOC.AttResAllocUENotInvolPS.
- f) RncFunction.
- g) Valid for packet switched traffic.
- h) UMTS.

##### 4.11.2.4.2 Successful relocation resource allocations with UE not involved for PS domain

- a) This measurement provides the number of successful relocation resource allocations with UE not involved for PS domain.
- b) CC.
- c) Transmission of a RANAP message RELOCATION REQUEST ACKNOWLEDGE from the target RNC to the PS CN (Target side), in response to a RELOCATION REQUEST message with Relocation Type set to "UE not involved in relocation of SRNS", indicating a successful relocation resource allocation with UE not involved for PS domain (see TS 25.413 [5]).
- d) A single integer value.
- e) RELOC.SuccResAllocUENotInvolPS.
- f) RncFunction.
- g) Valid for packet switched traffic.
- h) UMTS.

##### 4.11.2.4.3 Failed relocation resource allocations with UE not involved for PS domain

- a) This measurement provides the number of failed relocation resource allocations with UE not involved for PS domain per cause.
- b) CC.
- c) Transmission of a RANAP message RELOCATION FAILURE from the target RNC to the PS CN (Target side), in response to a RELOCATION REQUEST message with Relocation Type set to "UE not involved in relocation of SRNS", indicating a failed relocation resource allocation with UE not involved for PS domain. Failure causes are defined within TS 25.413 [5].

The sum of all supported per cause measurements shall equal the total number of failed events. In case only a subset of per cause measurements is supported, a sum subcounter will be provided first.

- d) Each measurement is an integer value. The number of measurements is equal to the number of causes supported plus a possible sum value identified by the *.sum* suffix.

- e) The measurement name has the form RELOC.FailResAllocUENotInvolPS.*Cause* where *Cause* identifies the failure cause.
- f) RncFunction.
- g) Valid for packet switched traffic.
- h) UMTS.

#### 4.11.2.5 Relocations for PS domain

##### 4.11.2.5.1 Successful relocations for PS domain

- a) This measurement provides the number of successful relocations for PS domain ('UE involved' and 'UE not involved' Relocations).
- b) CC.
- c) Receipt of a RANAP message Iu RELEASE COMMAND sent from the PS CN (Source side) to the source RNC in response to a RELOCATION REQUIRED message, indicating a successful relocation for PS domain (see TS 25.413 [5]).
- d) A single integer value.
- e) RELOC.SuccPS.
- f) RncFunction.
- g) Valid for packet switched traffic.
- h) UMTS.

## 4.12 Circuit switched inter-RAT handover

### 4.12.1 Relocation preparation for outgoing circuit switched inter-RAT handovers

The three measurement types defined in the subclause 4.12.1.n for relocation preparation for outgoing circuit switched inter-RAT handovers are subject to the "2 out of 3 approach".

#### 4.12.1.1 Attempted relocation preparation for outgoing circuit switched inter-RAT handovers

- a) This measurement provides the number of attempted relocation preparations for outgoing circuit switched inter-RAT handovers per neighbour cell.
- b) CC.
- c) Transmission of a RANAP message RELOCATION REQUIRED from the serving RNC to the CN, indicating an attempted relocation preparation of an outgoing inter-RAT handover (see TS 25.413 [5]).
- d) A single integer value.
- e) IRATHO.AttRelocPrepOutCS.
- f) GsmRelation.
- g) Valid for circuit switched traffic.
- h) UMTS.

#### 4.12.1.2 Successful relocation preparation for outgoing circuit switched inter-RAT handovers

- a) This measurement provides the number of successful relocation preparations for outgoing circuit switched inter-RAT handovers per neighbour cell.
- b) CC.
- c) Receipt of a RANAP message RELOCATION COMMAND sent from the CN to the serving RNC, indicating a successful relocation preparation of an inter-RAT handover (see TS 25.413 [5]).
- d) A single integer value.
- e) IRATHO.SuccRelocPrepOutCS.
- f) GsmRelation.
- g) Valid for circuit switched traffic.
- h) UMTS.

#### 4.12.1.3 Failed relocation preparation for outgoing circuit switched inter-RAT handovers

- a) This measurement provides number of failed relocation preparations for outgoing circuit switched inter-RAT handovers per neighbour cell per cause.
- b) CC.
- c) Receipt of a RANAP message RELOCATION PREPARATION FAILURE sent from the CN to the serving RNC, indicating a failed relocation preparation for outgoing inter-RAT handovers. Failure causes are defined within TS 25.413 [5].  
The sum of all supported per cause measurements shall equal the total number of failed events. In case only a subset of per cause measurements is supported, a sum subcounter will be provided first.
- d) Each measurement is an integer value. The number of measurements is equal to the number of causes supported plus a possible sum value identified by the *.sum* suffix.
- e) The measurement name has the form IRATHO.FailRelocPrepOutCS.*Cause* where *Cause* identifies the failure cause.
- f) GsmRelation.
- g) Valid for circuit switched traffic.
- h) UMTS.

### 4.12.2 Outgoing circuit switched inter-RAT handovers

The three measurement types defined in the subclause 4.12.2.n for outgoing circuit switched inter-RAT handovers are subject to the "2 out of 3 approach".

#### 4.12.2.1 Attempted outgoing circuit switched inter-RAT handovers

- a) This measurement provides the number of attempted outgoing circuit switched inter-RAT handovers per neighbour cell from UEs point of view.
- b) CC.
- c) Transmission of a RRC-message HANDOVER FROM UTRAN COMMAND from serving RNC to the UE, indicating an attempted outgoing inter-RAT handover (see TS 25.331 [4]).
- d) A single integer value.



- e) IRATHO.AttOutCS.
- f) GsmRelation.
- g) Valid for circuit switched traffic.
- h) UMTS.

#### 4.12.2.2 Successful outgoing circuit switched inter-RAT handovers

- a) This measurement provides the number of successful outgoing circuit switched inter-RAT handovers per neighbour cell from UEs point of view.
- b) CC.
- c) Receipt of a RANAP message IU RELEASE COMMAND sent from the CN to the serving RNC, indicating a successful inter-RAT handover (see TS 25.413 [5]).
- d) A single integer value.
- e) IRATHO.SuccOutCS.
- f) GsmRelation.
- g) Valid for circuit switched traffic.
- h) UMTS.

#### 4.12.2.3 Failed outgoing circuit switched inter-RAT handovers

- a) This measurement provides the number of failed outgoing circuit switched inter-RAT handovers per neighbour cell per cause from UEs point of view, where the UE returned to the original physical channel configuration.
- b) CC.
- c) Receipt of a RRC message HANDOVER FROM UTRAN FAILURE sent from the UE to the serving RNC, indicating a failed inter-RAT handover. Failure causes are defined within TS 25.331 [4].  
The sum of all supported per cause measurements shall equal the total number of failed events. In case only a subset of per cause measurements is supported, a sum subcounter will be provided first.
- d) Each measurement is an integer value. The number of measurements is equal to the number of causes supported plus a possible sum value identified by the *.sum* suffix.
- e) The measurement name has the form IRATHO.FailOutCS.*Cause* where *Cause* identifies the failure cause.
- f) GsmRelation.
- g) Valid for circuit switched traffic.
- h) UMTS.

### 4.12.3 Incoming circuit switched inter-RAT handovers

The three measurement types defined in the subclause 4.12.3.n for incoming circuit switched inter-RAT handovers are subject to the "2 out of 3 approach".

#### 4.12.3.1 Attempted incoming circuit switched inter-RAT handovers

- a) This measurement provides the number of attempted incoming circuit switched inter-RAT handovers for each cell.
- b) CC.

- c) Receipt of a RANAP RELOCATION REQUEST message sent from the CN to the target RNC, indicating the attempt of an inter-RAT handover (see TS 25.413 [5]).
- d) A single integer value.
- e) IRATHO.AttIncCS.
- f) UtranCell.
- g) Valid for circuit switched traffic.
- h) UMTS.

#### 4.12.3.2 Successful incoming circuit switched inter-RAT handovers

- a) This measurement provides the number of successful incoming circuit switched interRAT handovers for each cell.
- b) CC.
- c) Receipt of a RRC HANDOVER TO UTRAN COMPLETE message sent from the UE to the target RNC, indicating a successful interRAT handover (see TS 25.331 [4]).
- d) A single integer value.
- e) IRATHO.SuccIncCS.
- f) UtranCell.
- g) Valid for circuit switched traffic.
- h) UMTS.

#### 4.12.3.3 Failed incoming circuit switched inter-RAT handovers

- a) This measurement provides the number of failed incoming circuit switched interRAT handovers per cell per cause.
- b) CC.
- c) Transmission of a RANAP message RELOCATION FAILURE from the target RNC to the CN, indicating a failed inter-RAT handovers. Failure causes are defined within TS 25.413 [5].  
The sum of all supported per cause measurements shall equal the total number of failed events. In case only a subset of per cause measurements is supported, a sum subcounter will be provided first.
- d) Each measurement is an integer value. The number of measurements is equal to the number of causes supported plus a possible sum value identified by the *.sum* suffix.
- e) The measurement name has the form IRATHO.FailIncCS.*Cause* where *Cause* identifies the failure cause.
- f) UtranCell.
- g) Valid for circuit switched traffic.
- h) UMTS.

### 4.13 Packet switched inter-RAT handover

#### 4.13.1 Outgoing packet switched inter-RAT handovers, UTRAN controlled

The three measurement types defined in the subclause 4.13.1.n for outgoing packet switched inter-RAT handovers, UTRAN controlled are subject to the "2 out of 3 approach".

#### 4.13.1.1 Attempted outgoing packet switched inter-RAT handovers, UTRAN controlled

- a) This measurement provides the number of attempted outgoing, UTRAN controlled, Packet Switched interRAT handovers per cell.
- b) CC.
- c) Transmission of a RRC-message, CELL CHANGE ORDER FROM UTRAN, from source RNC to the UE, indicating an attempted outgoing Packet Switched inter-RAT handover (see TS 25.331 [4]).
- d) A single integer value.
- e) IRATHO.AttOutPSUTRAN.
- f) UtranCell.
- g) Valid for packet switched traffic.
- h) UMTS.

#### 4.13.1.2 Successful outgoing packet switched inter-RAT handovers, UTRAN controlled

- a) This measurement provides the number of successful outgoing, UTRAN controlled, Packet Switched interRAT handovers per cell.
- b) CC.
- c) Receipt of a RANAP message, IU RELEASE COMMAND, sent from the PS CN to the source RNC, indicating a successful outgoing Packet Switched inter-RAT handover (see TS 25.413 [5]).
- d) A single integer value.
- e) IRATHO.SuccOutPSUTRAN.
- f) UtranCell.
- g) Valid for packet switched traffic.
- h) UMTS.

#### 4.13.1.3 Failed outgoing packet switched inter-RAT handovers UTRAN controlled

- a) This measurement provides the number of failed outgoing, UTRAN controlled, Packet Switched interRAT handovers per cause, where the UE resumes the connection to UTRAN using the same resources used before receiving the cell change order. This is measured per cell.
- b) CC.
- c) Receipt of an RRC message, CELL CHANGE ORDER FROM UTRAN FAILURE, sent from the UE to the source RNC, indicating a failed inter-RAT handover. Failure causes are defined within TS 25.331 [4]. The sum of all supported per cause measurements shall equal the total number of failed events. In case only a subset of per cause measurements is supported, a sum subcounter will be provided first.
- d) Each measurement is an integer value. The number of measurements is equal to the number of causes supported plus a possible sum value identified by the *.sum* suffix.
- e) The measurement name has the form IRATHO.FailOutPSUTRAN.*Cause* where *Cause* identifies the failure cause.
- f) UtranCell.
- g) Valid for packet switched traffic.
- h) UMTS.

## 4.13.2 Outgoing packet switched inter-RAT handovers, UE controlled

### 4.13.2.1 Successful outgoing packet switched inter-RAT handovers, UE controlled

- a) This measurement provides the number of successful outgoing, UE controlled, Packet Switched inter-RAT handovers per cell.
- b) CC.
- c) Receipt of an RANAP message, SRNS CONTEXT REQUEST, sent from the PS CN to the serving RNC, indicating a successful outgoing UE controlled Packet Switched inter-RAT handover (see TS 25.413 [5]).
- d) A single integer value.
- e) IRATHO.SuccOutPSUE.
- f) UtranCell.
- g) Valid for packet switched traffic.
- h) UMTS.

## 4.14 Iu connection release

### 4.14.1 Overview

#### 4.14.1.1 Considered Iu connection release procedures

Performance Measurement definitions in this subclause are based on TS 25.413 [5].

The following paragraphs are of interest for this purpose:

- Iu Release Request;
- Iu Release;
- IU RELEASE REQUEST;
- IU RELEASE COMMAND;
- IU RELEASE COMPLETE.

These paragraphs show in particular the following diagrams:



**Figure: Iu Release Request procedure. Successful operation**

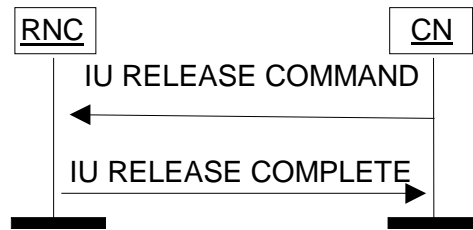

Figure: Iu Release procedure. Successful operation

## 4.14.2 Iu connection release request by UTRAN

### 4.14.2.1 Attempted Iu connection release request by UTRAN for CS domain

- a) This measurement provides the number of attempted requests by UTRAN to release an Iu connection between the RNC and a CS CN. The measurement is split into subcounters per release cause.
- b) CC.
- c) Transmission of a RANAP message IU RELEASE REQUEST by the RNC to the CS CN. Each RANAP message IU RELEASE REQUEST sent to the CS CN is added to the relevant per cause measurement. The possible causes are included in TS 25.413 [5]. The sum of all supported per cause measurements shall equal the total number of IU RELEASE REQUEST attempts. In case only a subset of per cause measurements is supported, a sum measurement subtype will be provided first.
- d) Each measurement is an integer value. The number of measurements is equal to the number of causes plus a possible sum value identified by the *.sum* suffix.
- e) The measurement name has the form *IU.AttConnRelReqUTRANCS.Cause* where *Cause* identifies the release cause.
- f) RncFunction.
- g) Valid for circuit switched traffic.
- h) UMTS.

### 4.14.2.2 Attempted Iu connection release request by UTRAN for PS domain

- a) This measurement provides the number of attempted requests by UTRAN to release an Iu connection between the RNC and a PS CN. The measurement is split into subcounters per release cause.
- b) CC.
- c) Transmission of a RANAP message IU RELEASE REQUEST by the RNC to the PS CN. Each RANAP message IU RELEASE REQUEST sent to the PS CN is added to the relevant per cause measurement. The possible release causes are included in TS 25.413 [5]. The sum of all supported per cause measurements shall equal the total number of IU RELEASE REQUEST attempts. In case only a subset of per cause measurements is supported, a sum measurement subtype will be provided first.
- d) Each measurement is an integer value. The number of measurements is equal to the number of causes plus a possible sum value identified by the *.sum* suffix.
- e) The measurement name has the form *IU.AttConnRelReqUTRANPS.Cause* where *Cause* identifies the release cause.
- f) RncFunction.
- g) Valid for packet switched traffic.
- h) UMTS.

### 4.14.3 Iu connection release by CN

#### 4.14.3.1 Attempted Iu connection release by CN for CS domain

- a) This measurement provides the number of attempted release by a CS CN to an Iu connection between the RNC and a CS CN. The measurement is split into subcounters per release cause.
- b) CC.
- c) Receipt of a RANAP message IU RELEASE COMMAND sent by the CS CN to the RNC. Each RANAP message IU RELEASE COMMAND received from the CS CN is added to the relevant per cause measurement. The possible causes are included in TS 25.413 [5]. The sum of all supported per cause measurements shall equal the total number of IU RELEASE COMMAND attempts. In case only a subset of per cause measurements is supported, a sum measurement subtype will be provided first.
- d) Each measurement is an integer value. The number of measurements is equal to the number of causes plus a possible sum value identified by the *.sum* suffix.
- e) The measurement name has the form *IU.AttConnRelCNCS.Cause* where *Cause* identifies the release cause.
- f) RncFunction.
- g) Valid for circuit switching.
- h) UMTS.

#### 4.14.3.2 Attempted Iu connection release by CN for PS domain

- a) This measurement provides the number of attempted release by a PS CN to an Iu connection between the RNC and a PS CN. The measurement is split into subcounters per release cause.
- b) CC.
- c) Receipt of a RANAP message IU RELEASE COMMAND sent by the PS CN to the RNC. Each RANAP message IU RELEASE COMMAND received from the PS CN is added to the relevant per cause measurement. The possible causes are included in TS 25.413 [5]. The sum of all supported per cause measurements shall equal the total number of IU RELEASE COMMAND attempts. In case only a subset of per cause measurements is supported, a sum measurement subtype will be provided first.
- d) Each measurement is an integer value. The number of measurements is equal to the number of causes plus a possible sum value identified by the *.sum* suffix.
- e) The measurement name has the form *IU.AttConnRelCNPS.Cause* where *Cause* identifies the release cause.
- f) RncFunction.
- g) Valid for packet switching.
- h) UMTS.

#### 4.14.3.3 Successful Iu connection release by CN for CS domain

- a) This measurement provides the number of successful release by a CS CN to an Iu connection between the RNC and a CS CN. The measurement is split into subcounters per release cause.
- b) CC.
- c) Transmission of a RANAP message IU RELEASE COMPLETE by the RNC to the CS CN. Each RANAP message IU RELEASE COMPLETE sent to the CS CN is added to the relevant per cause measurement. The possible causes are included in TS 25.413 [5]. The sum of all supported per cause measurements shall equal the total number of IU RELEASE COMPLETE. In case only a subset of per cause measurements is supported, a sum measurement subtype will be provided first.

- d) Each measurement is an integer value. The number of measurements is equal to the number of causes plus a possible sum value identified by the *.sum* suffix.
- e) The measurement name has the form *IU.SuccConnRelCNCS.Cause* where *Cause* identifies the release cause.
- f) *RncFunction*.
- g) Valid for circuit switching.
- h) UMTS.

#### 4.14.3.4 Successful Iu connection release by CN for PS domain

- a) This measurement provides the number of successful release by a PS CN to an Iu connection between the RNC and a PS CN. The measurement is split into subcounters per release cause.
- b) CC.
- c) Transmission of a RANAP message IU RELEASE COMPLETE by the RNC to the PS CN. Each RANAP message IU RELEASE COMPLETE sent to the PS CN is added to the relevant per cause measurement. The possible causes are included in TS 25.413 [5]. The sum of all supported per cause measurements shall equal the total number of IU RELEASE COMPLETE. In case only a subset of per cause measurements is supported, a sum measurement subtype will be provided first.
- d) Each measurement is an integer value. The number of measurements is equal to the number of causes plus a possible sum value identified by the *.sum* suffix.
- e) The measurement name has the form *IU.SuccConnRelCNPS.Cause* where *Cause* identifies the release cause.
- f) *RncFunction*.
- g) Valid for packet switching.
- h) UMTS.

---

## 5 Measurements related to the SGSN

### 5.1 Mobility Management

#### 5.1.1 GPRS attach procedures

The four measurements defined in the clause 5.1.1 are subject to the "3 out of 4 approach".

NOTE: Number of Attempted GPRS attach procedures = Number of Successful GPRS attach procedures + Total Number of Failed GPRS attach procedures + Aborted GPRS attach procedures.

##### 5.1.1.1 Attempted GPRS attach procedures

- a) This measurement provides the number of attempted GPRS attach procedures initiated within this SGSN area. The three measurement types defined in e) are subject to the "2 out of 3 approach".
- b) CC.
- c) Receipt of "ATTACH REQUEST" message with "Attach type" information element indicating "GPRS attach" from the MS (TS 24.008).
- d) A single integer value per measurement type defined in e).

- e) MM.AttGprsAttach:
- MM.AttGprsAttach Combined (don't care);
  - MM.AttGprsAttach.G GSM;
  - MM.AttGprsAttach.U UMTS.
- f) RA, specified by a concatenation of the MCC, MNC, LAC and the RAC.
- g) Valid for packet switching.
- h) GSM/UMTS.

### 5.1.1.2 Successful GPRS attach procedures

- a) This measurement provides the number of successfully performed GPRS attach procedures within this SGSN area.  
The three measurement types defined in e) are subject to the "2 out of 3 approach".
- b) CC.
- c) Transmission of a "ATTACH ACCEPT" message to the MS, in response to a "ATTACH REQUEST" message with the "Attach type" information element indicating "GPRS attach". If the "ATTACH ACCEPT" message is caused by a retransmission, this will not cause the counter to be increased. (TS 24.008).
- d) A single integer value per measurement type defined in e).
- e) MM.SuccGprsAttach:
- MM.SuccGprsAttach Combined (don't care);
  - MM.SuccGprsAttach.G GSM;
  - MM.SuccGprsAttach.U UMTS.
- f) RA, specified by a concatenation of the MCC, MNC, LAC and the RAC.
- g) Valid for packet switching.
- h) GSM/UMTS.

### 5.1.1.3 Failed GPRS attach procedures

- a) This measurement provides the number of failed GPRS attach procedures. The measurement is split into subcounters per the reject cause. The three measurements defined in e) are subject to the "2 out of 3 approach".
- b) CC
- c) Transmission by the SGSN of the ATTACH REJECT message to the MS, in response to a "ATTACH REQUEST" message with the "Attach type" information element indicating "GPRS attach", the relevant measurement is incremented according to the reject cause. Possible reject causes are defined within TS 24.008 [15].  
The sum of all supported per cause measurements shall be equal to the total number of failed GPRS attach procedures. In case only a subset of per cause measurements is supported, a sum subcounter will be provided first.
- d) Each measurement (as defined in e) is an integer value. The number of measurements is equal to the number of causes supported plus a possible sum value identified by the *.sum* suffix.
- e) MM. FailedGprsAttach.Cause:
- MM. FailedGprsAttach.Cause Combined (don't care);
  - MM. FailedGprsAttach.Cause.G GSM;



- MM. FailedGprsAttach.Cause.U UMTS;  
where *Cause* identifies the reject cause.
- f) RA, specified by a concatenation of the MCC, MNC, LAC and the RAC.
- g) Valid for packet switching
- h) GSM/UMTS

#### 5.1.1.4 Aborted GPRS attach procedures

- a) This measurement provides the number of aborted GPRS attach procedures. The three measurements defined in e) are subject to the "2 out of 3 approach".
- b) CC
- c) Abortion of a GPRS attach procedure, or a "ATTACH REQUEST" message with "Attach type" information element indicating "GPRS attach" would not be treated (TS 24.008).
- d) A single integer value per measurement type defined in e).
- e) MM.AbortedGprsAttach:
  - MM. AbortedGprsAttach Combined (don't care);
  - MM. AbortedGprsAttach.G GSM;
  - MM. AbortedGprsAttach.U UMTS.
- f) RA, specified by a concatenation of the MCC, MNC, LAC and the RAC.
- g) Valid for packet switching
- h) GSM/UMTS

#### 5.1.2 Intra-SGSN Routing Area update procedures

##### 5.1.2.1 Attempted intra-SGSN Routing Area update procedures

- a) This measurement provides the number of attempted intra-SGSN Routing Area Update procedures initiated within this SGSN area.  
The three measurement types defined in e) are subject to the "2 out of 3 approach".
- b) CC.
- c) Receipt of a "ROUTING AREA UPDATE REQUEST" message from the MS, where the old RA and the new RA are served by this SGSN (TS 24.008).
- d) A single integer value per measurement type defined in e).
- e) MM.AttIntraSgsnRaUpdate:
  - MM.AttIntraSgsnRaUpdate Combined (don't care);
  - MM.AttIntraSgsnRaUpdate.G GSM;
  - MM.AttIntraSgsnRaUpdate.U UMTS.
- f) RA, specified by a concatenation of the MCC, MNC, LAC and the RAC.
- g) Valid for packet switching.
- h) GSM/UMTS.

### 5.1.2.2 Successful intra-SGSN Routing Area update procedures

- a) This measurement provides the number of successfully performed intra-SGSN Routing Area Update procedures initiated in this SGSN.  
The three measurement types defined in e) are subject to the "2 out of 3 approach".
- b) CC.
- c) Transmission of "ROUTING AREA UPDATE ACCEPT" message to the MS (TS 24.008).
- d) A single integer value.
- e) MM.SuccIntraSgsnRaUpdate:
  - MM.SuccIntraSgsnRaUpdate Combined (don't care);
  - MM.SuccIntraSgsnRaUpdate.G GSM;
  - MM.SuccIntraSgsnRaUpdate.U UMTS.
- f) RA, specified by a concatenation of the MCC, MNC, LAC and the RAC.
- g) Valid for packet switching.
- h) GSM/UMTS.

### 5.1.3 GPRS detach procedures initiated by MS

#### 5.1.3.1 Attempted GPRS detach procedures initiated by MS

- a) This measurement provides the number of MS initiated GPRS detach procedures within this SGSN area.  
The three measurement types defined in e) are subject to the "2 out of 3 approach".
- b) CC.
- c) Receipt of a "DETACH REQUEST" message from the MS indicating a GPRS detach (TS 24.008).
- d) A single integer value per measurement type defined in e).
- e) MM.AttGprsDetachMs:
  - MM.AttGprsDetachMs Combined (don't care);
  - MM.AttGprsDetachMs.G GSM;
  - MM.AttGprsDetachMs.U UMTS.
- f) RA, specified by a concatenation of the MCC, MNC, LAC and the RAC.
- g) Valid for packet switching.
- h) GSM/UMTS.

### 5.1.4 GPRS detach procedures initiated by SGSN

#### 5.1.4.1 Attempted GPRS detach procedures initiated by SGSN

- a) This measurement provides the number of attempted GPRS detach procedures initiated by SGSN.  
The three measurement types defined in e) are subject to the "2 out of 3 approach".
- b) CC.
- c) Transmission of a "DETACH REQUEST" message to the MS (TS 24.008).
- d) A single integer value per measurement type defined in e).

- e) MM.AttGprsDetachSgsn:
  - MM.AttGprsDetachSgsn Combined (don't care);
  - MM.AttGprsDetachSgsn.G GSM;
  - MM.AttGprsDetachSgsn.U UMTS.
- f) RA, specified by a concatenation of the MCC, MNC, LAC and the RAC.
- g) Valid for packet switching.
- h) GSM/UMTS.

#### 5.1.4.2 Successful GPRS detach procedures initiated by SGSN

- a) This measurement provides the number of successfully completed GPRS detach procedures SGSN-initiated within this SGSN area.  
The three measurement types defined in e) are subject to the "2 out of 3 approach".
- b) CC.
- c) Receipt of "DETACH ACCEPT" message from the MS (TS 24.008).
- d) A single integer value per measurement type defined in e).
- e) MM.SuccGprsDetachSgsn:
  - MM.SuccGprsDetachSgsn Combined (don't care);
  - MM.SuccGprsDetachSgsn.G GSM;
  - MM.SuccGprsDetachSgsn.U UMTS.
- f) RA, specified by a concatenation of the MCC, MNC, LAC and the RAC.
- g) Valid for packet switching.  
GSM/UMTS.

#### 5.1.5 Inter-SGSN Routing Area update procedures

##### 5.1.5.1 Attempted inter-SGSN Routing Area update procedures

- a) This measurement provides the number of attempted inter-SGSN Routing Area Update procedures initiated in this SGSN.  
The three measurement types defined in e) are subject to the "2 out of 3 approach".
- b) CC.
- c) Receipt of an "ROUTING AREA UPDATE REQUEST" message from the MS where the old RA is served by another SGSNs (TS 24.008).
- d) A single integer value per measurement type defined in e).
- e) MM.AttInterSgsnRaUpdate:
  - MM.AttInterSgsnRaUpdate Combined (don't care);
  - MM.AttInterSgsnRaUpdate.G GSM;
  - MM.AttInterSgsnRaUpdate.U UMTS.
- f) RA, specified by a concatenation of the MCC, MNC, LAC and the RAC.
- g) Valid for packet switching.

- h) GSM/UMTS.

#### 5.1.5.2 Successful inter-SGSN Routing Area update procedures

- a) This measurement provides the number of successfully completed inter-SGSN Routing Area Update procedures in this SGSN.  
The three measurement types defined in e) are subject to the "2 out of 3 approach".
- b) CC.
- c) Transmission of a "ROUTING AREA UPDATE ACCEPT" message to the MS (TS 24.008).
- d) A single integer value per measurement type defined in e).
- e) MM.SuccInterSgsnRaUpdate:
  - MM.SuccInterSgsnRaUpdate Combined (don't care);
  - MM.SuccInterSgsnRaUpdate.G GSM;
  - MM.SuccInterSgsnRaUpdate.U UMTS.
- f) RA, specified by a concatenation of the MCC, MNC, LAC and the RAC.
- g) Valid for packet switching.
- h) GSM/UMTS.

#### 5.1.6 GPRS attach procedures with IMSI already attached

The four measurements defined in the clause 5.1.6 are subject to the "3 out of 4 approach".

NOTE: Number of Attempted GPRS attach procedures with IMSI already attached = Number of Successful GPRS attach procedures with IMSI already attached + Total Number of Failed GPRS attach procedures with IMSI already attached + Aborted GPRS attach procedures with IMSI already attached.

##### 5.1.6.1 Attempted GPRS attach procedures with IMSI already attached

- a) This measurement provides the number of attempted GPRS attach procedures, while IMSI is already attached.  
The three measurement types defined in e) are subject to the "2 out of 3 approach".
- b) CC.
- c) Receipt of "ATTACH REQUEST" Message with "Attach type" information element indicating "GPRS attach while IMSI attached" from the MS (TS 24.008).
- d) A single integer value per measurement type defined in e).
- e) MM.AttGprsAttachImsiAttached:
  - MM.AttGprsAttachImsiAttached Combined (don't care);
  - MM.AttGprsAttachImsiAttached.G GSM;
  - MM.AttGprsAttachImsiAttached.U UMTS.
- f) RA, specified by a concatenation of the MCC, MNC, LAC and the RAC.
- g) Valid for packet switching.
- h) GSM/UMTS.

### 5.1.6.2 Successful GPRS attach procedures with IMSI already attached

- a) This measurement provides the number of successfully performed GPRS attach procedures with IMSI already attached within this SGSN area.  
The three measurement types defined in e) are subject to the "2 out of 3 approach".
- b) CC.
- c) Transmission of a "ATTACH ACCEPT" message to the MS, in response to a "ATTACH REQUEST" message with the "Attach type" information element indicating "GPRS attach while IMSI attached". If the "ATTACH ACCEPT" message is caused by a retransmission, this will not cause the counter to be increased. (TS 24.008).
- d) A single integer value per measurement type defined in e).
- e) MM.SuccGprsAttachImsiAttached:
  - MM.SuccGprsAttachImsiAttached Combined (don't care);
  - MM.SuccGprsAttachImsiAttached.G GSM;
  - MM.SuccGprsAttachImsiAttached.U UMTS.
- f) RA, specified by a concatenation of the MCC, MNC, LAC and the RAC.
- g) Valid for packet switching.
- h) GSM/UMTS.

### 5.1.6.3 Failed GPRS attach procedures with IMSI already attached

- a) This measurement provides the number of failed GPRS attach procedures with IMSI already attached. The measurement is split into subcounters per the reject cause. The three measurements defined in e) are subject to the "2 out of 3 approach".
- b) CC
- c) Transmission by the SGSN of the ATTACH REJECT message to the MS, in response to a "ATTACH REQUEST" message with the "Attach type" information element indicating "GPRS attach while IMSI attached", the relevant measurement is incremented according to the reject cause. Possible reject causes are defined within TS 24.008 [15].  
The sum of all supported per cause measurements shall be equal to the total number of failed GPRS attach procedures with IMSI already attached. In case only a subset of per cause measurements is supported, a sum subcounter will be provided first.
- d) Each measurement (as defined in e) is an integer value. The number of measurements is equal to the number of causes supported plus a possible sum value identified by the .sum suffix.
- e) MM. FailedGprsAttachImsiAttached.Cause:
  - MM. FailedGprsAttachImsiAttached.Cause Combined (don't care);
  - MM. FailedGprsAttachImsiAttached.Cause.G GSM;
  - MM. FailedGprsAttachImsiAttached.Cause.U UMTS;
 where *Cause* identifies the reject cause.
- f) RA, specified by a concatenation of the MCC, MNC, LAC and the RAC.
- g) Valid for packet switching.
- h) GSM/UMTS.

#### 5.1.6.4 Aborted GPRS attach procedures with IMSI already attached

- a) This measurement provides the number of aborted GPRS attach procedures with IMSI already attached. The three measurements defined in e) are subject to the "2 out of 3 approach".
- b) CC.
- c) Abortion of a GPRS attach procedure with IMSI already attached, or a "ATTACH REQUEST" message with "Attach type" information element indicating "GPRS attach while IMSI attached" would not be treated (TS 24.008).
- d) A single integer value per measurement type defined in e).
- e) MM.AbortedGprsAttachImsiAttached:
  - MM. AbortedGprsAttachImsiAttached Combined (don't care);
  - MM. AbortedGprsAttachImsiAttached.G GSM;
  - MM. AbortedGprsAttachImsiAttached.U UMTS.
- f) RA, specified by a concatenation of the MCC, MNC, LAC and the RAC.
- g) Valid for packet switching.
- h) GSM/UMTS.

#### 5.1.7 IMSI detach procedures initiated by MS

##### 5.1.7.1 Attempted IMSI detach procedures initiated by MS

- a) This measurement provides the number of attempted IMSI detach procedures MS-initiated within this SGSN area.  
The three measurement types defined in e) are subject to the "2 out of 3 approach".
- b) CC.
- c) Receipt of a "DETACH REQUEST" message from the MS, indicating a IMSI detach (TS 24.008).
- d) A single integer value per measurement type defined in e).
- e) MM.AttImsiDetachMs:
  - MM.AttImsiDetachMs Combined (don't care);
  - MM.AttImsiDetachMs.G GSM;
  - MM.AttImsiDetachMs.U UMTS.
- f) RA, specified by a concatenation of the MCC, MNC, LAC and the RAC.
- g) Valid for packet switching.
- h) GSM/UMTS.

#### 5.1.8 Combined GPRS/IMSI attach procedures

The four measurements defined in the clause 5.1.8 are subject to the "3 out of 4 approach".

NOTE: Number of Attempted combined GPRS/IMSI attach procedures = Number of Successful combined GPRS/IMSI attach procedures + Total Number of Failed combined GPRS/IMSI attach procedures + Aborted combined GPRS/IMSI attach procedures.

### 5.1.8.1 Attempted combined GPRS/IMSI attach procedures

- a) This measurement provides the number of attempts of combined GPRS/IMSI attach procedures initiated within this SGSN area.  
The three measurement types defined in e) are subject to the "2 out of 3 approach".
- b) CC.
- c) Receipt of a "ATTACH REQUEST" message with "Attach type" information element indicating "Combined GPRS/IMSI attach" from the MS (TS 24.008).
- d) A single integer value per measurement type defined in e) .
- e) MM.AttCombiAttach:
  - MM.AttCombiAttach Combined (don't care);
  - MM.AttCombiAttach.G GSM;
  - MM.AttCombiAttach.U UMTS.
- f) RA, specified by a concatenation of the MCC, MNC, LAC and the RAC.
- g) Valid for packet switching.
- h) GSM/UMTS.

### 5.1.8.2 Successful combined GPRS/IMSI attach procedures

- a) This measurement provides the number of successfully performed combined GPRS/IMSI attach procedures within this SGSN area.  
The three measurement types defined in e) are subject to the "2 out of 3 approach".
- b) CC.
- c) Transmission of a "ATTACH ACCEPT" message to the MS, in response to a "ATTACH REQUEST" message with the "Attach type" information element indicating "Combined GPRS/IMSI attach". If the "ATTACH ACCEPT" message is caused by a retransmission, this will not cause the counter to be increased. (TS 24.008).
- d) A single integer value per measurement type defined in e).
- e) MM.SuccCombiAttach:
  - MM.SuccCombiAttach Combined (don't care);
  - MM.SuccCombiAttach.G GSM;
  - MM.SuccCombiAttach.U UMTS.
- f) RA, specified by a concatenation of the MCC, MNC, LAC and the RAC.
- g) Valid for packet switching.
- h) GSM/UMTS.

### 5.1.8.3 Failed combined GPRS/IMSI attach procedures

- a) This measurement provides the number of failed combined GPRS/IMSI attach procedures. The measurement is split into subcounters per the reject cause. The three measurements defined in e) are subject to the "2 out of 3 approach".
- b) CC

- c) Transmission by the SGSN of the ATTACH REJECT message to the MS, in response to a "ATTACH REQUEST" message with the "Attach type" information element indicating "Combined GPRS/IMSI attach", the relevant measurement is incremented according to the reject cause. Possible reject causes are defined within TS 24.008 [15].  
The sum of all supported per cause measurements shall be equal to the total number of failed combined GPRS/IMSI attach procedures. In case only a subset of per cause measurements is supported, a sum subcounter will be provided first.
- d) Each measurement (as defined in e) is an integer value. The number of measurements is equal to the number of causes supported plus a possible sum value identified by the .sum suffix.
- e) MM.FailedCombiAttach.Cause:
- MM.FailedCombiAttach.Cause Combined (don't care);
  - MM.FailedCombiAttach.Cause.G GSM;
  - MM.FailedCombiAttach.Cause.U UMTS;
- where Cause identifies the reject cause.
- f) RA, specified by a concatenation of the MCC, MNC, LAC and the RAC.
- g) Valid for packet switching.
- h) GSM/UMTS.

#### 5.1.8.4 Aborted combined GPRS/IMSI attach procedures

- a) This measurement provides the number of aborted combined GPRS/IMSI attach procedures. The three measurements defined in e) are subject to the "2 out of 3 approach".
- b) CC.
- c) Abortion of a combined GPRS/IMSI attach procedure, or a "ATTACH REQUEST" message with "Attach type" information element indicating "Combined GPRS/IMSI attach" would not be treated (TS 24.008).
- d) A single integer value per measurement type defined in e).
- e) MM.AbortedCombiAttach:
- MM.AbortedCombiAttach Combined (don't care);
  - MM.AbortedCombiAttach.G GSM;
  - MM.AbortedCombiAttach.U UMTS.
- f) RA, specified by a concatenation of the MCC, MNC, LAC and the RAC.
- g) Valid for packet switching.
- h) GSM/UMTS.

#### 5.1.9 Combined GPRS/IMSI detach procedures initiated by MS

##### 5.1.9.1 Attempted combined GPRS/IMSI detach procedures initiated by MS

- a) This measurement provides the number of attempted Combined GPRS/IMSI detach procedures MS-initiated within this SGSN area.  
The three measurement types defined in e) are subject to the "2 out of 3 approach".
- b) CC.
- c) Receipt of "DETACH REQUEST" message from the MS, indicating a Combined GPRS/IMSI detach (TS 24.008).



- d) A single integer value per measurement type defined in e).
- e) MM.AttCombiDetachMs:
  - MM.AttCombiDetachMs Combined (don't care);
  - MM.AttCombiDetachMs.G GSM;
  - MM.AttCombiDetachMs.U UMTS.
- f) RA, specified by a concatenation of the MCC, MNC, LAC and the RAC.
- g) Valid for packet switching.
- h) GSM/UMTS.

## 5.1.10 Combined RA/LA intra-SGSN Routing Area update procedures

### 5.1.10.1 Attempted combined RA/LA intra-SGSN Routing Area update procedures

- a) This measurement provides the number of combined RA/LA updates (intra-SGSN) procedures initiated in this SGSN. These are counted as attempts.  
The three measurement types defined in e) are subject to the "2 out of 3 approach".
- b) CC.
- c) Receipt of "Routing Area Update REQUEST" message from the MS, indicating a combined RA/LA update (TS 24.008).
- d) A single integer value per measurement type defined in e).
- e) MM.AttCombiIntraSgsnRaUpdate:
  - MM.AttCombiIntraSgsnRaUpdate Combined (don't care);
  - MM.AttCombiIntraSgsnRaUpdate.G GSM;
  - MM.AttCombiIntraSgsnRaUpdate.U UMTS.
- f) RA, specified by a concatenation of the MCC, MNC, LAC and the RAC.
- g) Valid for packet switching.
- h) GSM/UMTS.

### 5.1.10.2 Successful combined RA/LA intra-SGSN Routing Area update procedures

- a) This measurement provides the number of success-fully performed combined RA/LA updates (intra-SGSN) procedures initiated in this SGSN.  
The three measurement types defined in e) are subject to the "2 out of 3 approach".
- b) CC.
- c) Transmission of "Routing Area Update ACCEPT" message to the MS (TS 24.008).
- d) A single integer value per measurement type defined in e).
- e) MM.SuccCombiIntraSgsnRaUpdate:
  - MM.SuccCombiIntraSgsnRaUpdate Combined (don't care);
  - MM.SuccCombiIntraSgsnRaUpdate.G GSM;
  - MM.SuccCombiIntraSgsnRaUpdate.U UMTS.
- f) RA, specified by a concatenation of the MCC, MNC, LAC and the RAC.

- g) Valid for packet switching.
- h) GSM/UMTS.

### 5.1.11 "Combined RA/LA with IMSI Attach" intra-SGSN Routing Area update procedures

#### 5.1.11.1 Attempted "combined RA/LA with IMSI Attach" intra-SGSN Routing Area update procedures

- a) This measurement provides the number of combined RA/LA updates with IMSI attach (intra-SGSN) procedures initiated in this SGSN. These are counted as attempts.  
The three measurement types defined in e) are subject to the "2 out of 3 approach".
- b) CC.
- c) Receipt of "Routing Area Update REQUEST" message from the MS, indicating a combined RA/LA update with IMSI attach (TS 24.008).
- d) A single integer value per measurement type defined in e).
- e) MM.AttImsiCombiIntraSgsnRAUpdate:
  - MM.AttImsiCombiIntraSgsnRAUpdate Combined (don't care);
  - MM.AttImsiCombiIntraSgsnRAUpdate.G GSM;
  - MM.AttImsiCombiIntraSgsnRAUpdate.U UMTS.
- f) RA, specified by a concatenation of the MCC, MNC, LAC and the RAC.
- g) Valid for packet switching.
- h) GSM/UMTS.

### 5.1.12 Combined RA/LA inter-SGSN Routing Area update procedures

#### 5.1.12.1 Attempted combined RA/LA inter-SGSN Routing Area update procedures

- a) This measurement provides the number of combined RA/LA updates (inter-SGSN) procedures initiated in this SGSN. These are counted as attempts.  
The three measurement types defined in e) are subject to the "2 out of 3 approach".
- b) CC.
- c) Receipt of "Routing Area Update REQUEST" message from the MS, indicating a combined RA/LA update (TS 24.008).
- d) A single integer value per measurement type defined in e).
- e) MM.AttCombiInterSgsnRaUpdate:
  - MM.AttCombiInterSgsnRaUpdate Combined (don't care);
  - MM.AttCombiInterSgsnRaUpdate.G GSM;
  - MM.AttCombiInterSgsnRaUpdate.U UMTS.
- f) RA, specified by a concatenation of the MCC, MNC, LAC and the RAC.
- g) Valid for packet switching.
- h) GSM/UMTS.

### 5.1.12.2 Successful combined RA/LA inter-SGSN Routing Area update procedures

- a) This measurement provides the number of success-fully performed combined RA/LA updates (inter-SGSN) procedures initiated in this SGSN.  
The three measurement types defined in e) are subject to the "2 out of 3 approach".
- b) CC.
- c) Transmission of "Routing Area Update ACCEPT" message to the MS (TS 24.008).
- d) A single integer value per measurement type defined in e).
- e) MM.SuccCombiInterSgsnRaUpdate:
  - MM.SuccCombiInterSgsnRaUpdate Combined (don't care);
  - MM.SuccCombiInterSgsnRaUpdate.G GSM;
  - MM.SuccCombiInterSgsnRaUpdate.U UMTS.
- f) RA, specified by a concatenation of the MCC, MNC, LAC and the RAC.
- g) Valid for packet switching.
- h) GSM/UMTS.

### 5.1.13 "Combined RA/LA with IMSI Attach" inter-SGSN Routing Area update procedures

#### 5.1.13.1 Attempted "combined RA/LA with IMSI Attach" inter-SGSN Routing Area update procedures

- a) This measurement provides the number of combined RA/LA updates with IMSI attach (inter-SGSN) procedures initiated in this SGSN. These are counted as attempts:  
The three measurement types defined in e) are subject to the "2 out of 3 approach".
- b) CC.
- c) Receipt of "Routing Area Update REQUEST" message from the MS, indicating a combined RA/LA update with IMSI attach.E52.
- d) A single integer value per measurement type defined in e).
- e) MM.AttImsiCombiInterSgsnRAUpdate:
  - MM.AttImsiCombiInterSgsnRAUpdate Combined (don't care);
  - MM.AttImsiCombiInterSgsnRAUpdate.G GSM;
  - MM.AttImsiCombiInterSgsnRAUpdate.U UMTS.
- f) RA, specified by a concatenation of the MCC, MNC, LAC and the RAC.
- g) Valid for packet switching.
- h) GSM/UMTS.

### 5.1.14 Number of received invalid P-TMSI's during detach

- a) This measurement provides the number of received invalid P-TMSI's during detach.  
The three measurement types defined in e) are subject to the "2 out of 3 approach".
- b) CC.

- c) Receipt of an "DETACH\_REQUEST" with invalid P-TMSI (TS 24.008).
- d) A single integer value per measurement type defined in e).
- e) MM.NbrPTMSIDetachFail:
  - MM.NbrPTMSIDetachFail Combined (don't care);
  - MM.NbrPTMSIDetachFail.G GSM;
  - MM.NbrPTMSIDetachFail.U UMTS.
- f) RA, specified by a concatenation of the MCC, MNC, LAC and the RAC.
- g) Valid for packet switching.
- h) GSM/UMTS.

### 5.1.15 GSM PS paging procedures

The three measurement types defined in clauses 5.1.15.n are subject to the "2 out of 3 approach".

#### 5.1.15.1 Attempted GSM PS paging procedures

- a) This measurement provides the number of attempted PS paging procedures initiated at the SGSN over the Gb interface. The initial paging procedures as well as the repeated paging procedures are counted.
- b) CC.
- c) Incremented when a GSM PS paging procedure is started, i.e. at the transmission of the first BSSGP Paging Request (GSM 08.18) from the SGSN to the MS.
- d) A single integer value.
- e) MM.AttPsPagingProcGb.
- f) RA, specified by a concatenation of the MCC, MNC, LAC and the RAC.
- g) Valid for packet switching.
- h) GSM.

#### 5.1.15.2 Successful GSM PS paging procedures

- a) This measurement provides the number of successful PS paging procedures initiated at the SGSN over the Gb interface. The initial paging procedures as well as the repeated paging procedures are counted.
- b) CC.
- c) Incremented when an uplink\_trigger (any LLC frame) is received by the SGSN from the MS (over the Gb interface) as response to a GSM PS paging procedure (TS 23.060) or during intersystem change UMTS -> GSM.
- d) A single integer value.
- e) MM.SuccPsPagingProcGb.
- f) RA, specified by a concatenation of the MCC, MNC, LAC and the RAC.
- g) Valid for packet switching.
- h) GSM.

### 5.1.15.3 Failed GSM PS paging procedures

- a) This measurement provides the number of failed PS paging procedures initiated at the SGSN over the Gb interface, i.e. PS paging procedures that time out. The initial paging procedures as well as the repeated paging procedures are counted.
- b) CC.
- c) Incremented when a GSM PS paging procedure times out.
- d) A single integer value.
- e) MM.FailPsPagingProcGb.
- f) RA, specified by a concatenation of the MCC, MNC, LAC and the RAC.
- g) Valid for packet switching.
- h) GSM.

### 5.1.16 UMTS PS paging procedures

The three measurement types defined in clauses 5.1.16.n are subject to the "2 out of 3 approach".

#### 5.1.16.1 Attempted UMTS PS paging procedures

- a) This measurement provides the number of attempted PS paging procedures initiated at the SGSN over the Iu interface. The initial paging procedures as well as the repeated paging procedures are counted.
- b) CC.
- c) Incremented when a UMTS PS paging procedure is started i.e. at the transmission of the first "Paging" message (TS 25.413 [5]) from the SGSN to the MS.
- d) A single integer value.
- e) MM.AttPsPagingProcIu.
- f) RA, specified by a concatenation of the MCC, MNC, LAC and the RAC.
- g) Valid for packet switching.
- h) UMTS.

#### 5.1.16.2 Successful UMTS PS paging procedures

- a) This measurement provides the number of successful PS paging procedures initiated at the SGSN over the Iu interface. The initial paging procedures as well as the repeated paging procedures are counted.
- b) CC.
- c) Incremented when a paging\_response is received by the SGSN from the MS (over the Iu interface) as response to a UMTS PS paging procedure (Receipt of "Service Request" message with Service Type = Paging Response from the MS (TS 24.008)) or during intersystem change GSM -> UMTS.
- d) A single integer value.
- e) MM.SuccPsPagingProcIu.
- f) RA, specified by a concatenation of the MCC, MNC, LAC and the RAC.
- g) Valid for packet switching.
- h) UMTS.

### 5.1.16.3 Failed UMTS PS paging procedures

- a) This measurement provides the number of failed PS paging procedures initiated at the SGSN over the Iu interface, i.e. PS paging procedures that time out. The initial paging procedures as well as the repeated paging procedures are counted.
- b) CC.
- c) Incremented when a UMTS PS paging procedure times out.
- d) A single integer value.
- e) MM.FailPsPagingProcIu.
- f) RA, specified by a concatenation of the MCC, MNC, LAC and the RAC.
- g) Valid for packet switching.
- h) UMTS.

### 5.1.17 PS paging procedures with unknown access type

#### 5.1.17.1 Attempted PS paging procedures with unknown access type

- a) This measurement provides the number of attempted PS paging procedures initiated at the SGSN with access type unknown. In this case the paging will be done both over the Gb and the Iu interface. The initial paging procedures as well as the repeated paging procedures are counted.
- b) CC.
- c) Incremented when a paging procedure is started for which MM doesn't know the access type i.e. at the transmission of the first BSSGP Paging Request (GSM 08.18) and/or "Paging" message (TS 25.413 [5]) from the SGSN to the MS.
- d) A single integer value.
- e) MM.AttPsPagingProcGbIu.
- f) RA, specified by a concatenation of the MCC, MNC, LAC and the RAC.
- g) Valid for packet switching.
- h) Combined.

### 5.1.18 Number of PS paging message sends from 2G-SGSN to the MS

- a) This measurement provides the Number of PS paging message sends from 2G-SGSN to the MS.
- b) CC.
- c) Transmission of "GMM-PAGING.req" (GSM 08.18) from the SGSN to the MS. Each paging message will be counted separately, addressed to all BSS in this certain RA.
- d) A single integer value.
- e) MM.NbrPsPagingMesGb.
- f) RA, specified by a concatenation of the MCC, MNC, LAC and the RAC.
- g) Valid for packet switching.
- h) GSM.

## 5.1.19 Number of PS paging message sends from 3G-SGSN to the MS

- a) This measurement provides the Number of PS paging message sends from 3G-SGSN to the MS.
- b) CC.
- c) Transmission of "Paging" message (CN Domain Indicator = PS Domain) from the SGSN to the MS (TS 25.413 [5]). Each paging message will be counted separately, addressed to all RNC in this certain RA.
- d) A single integer value.
- e) MM.NbrPsPagingMesIu.
- f) RA, specified by a concatenation of the MCC, MNC, LAC and the RAC.
- g) Valid for packet switching.
- h) UMTS.

## 5.1.20 GSM subscribers state

### 5.1.20.1 Subscribers in STANDBY state

#### 5.1.20.1.1 Number of subscribers in STANDBY state

- a) This measurement provides the number of subscribers in STANDBY state.
- b) GAUGE.
- c) Incremented at transition of a subscriber registered in the SGSN into STANDBY state, decremented at transition of a subscriber registered in the SGSN out from STANDBY state.
- d) A single integer value.
- e) MM.NbrSubStandby.
- f) SgsnFunction.
- g) Valid for packet switching.
- h) GSM.

#### 5.1.20.1.2 Mean number of subscribers in STANDBY state

- a) This measurement provides the mean number of subscribers in STANDBY state.
- b) SI.
- c) This measurement is obtained by sampling at a pre-defined interval the number of subscribers in STANDBY state and then taking the arithmetic mean.
- d) A single integer value.
- e) MM.MeanNbrSubStandby.
- f) SgsnFunction.
- g) Valid for packet switching.
- h) GSM.

#### 5.1.20.1.3 Max number of subscribers in STANDBY state

- a) This measurement provides the maximum number of subscribers in STANDBY state.

- b) SI.
- c) This measurement is obtained by sampling at a pre-defined interval the number of subscribers in STANDBY state and then taking the maximum.
- d) A single integer value.
- e) MM.MaxNbrSubStandby.
- f) SgsnFunction.
- g) Valid for packet switching.
- h) GSM.

## 5.1.20.2 Subscribers in READY state

### 5.1.20.2.1 Number of subscribers in READY state

- a) This measurement provides the number of subscribers in READY state.
- b) GAUGE.
- c) Incremented at transition of a subscriber registered in the SGSN into READY state, decremented at transition of a subscriber registered in the SGSN out from READY state.
- d) A single integer value.
- e) MM.NbrSubReady
- f) SgsnFunction.
- g) Valid for packet switching.
- h) GSM.

### 5.1.20.2.2 Mean number of subscribers in READY state

- a) This measurement provides the mean number of subscribers in READY state.
- b) SI.
- c) This measurement is obtained by sampling at a pre-defined interval the number of subscribers in READY state and then taking the arithmetic mean.
- d) A single integer value.
- e) MM.MeanNbrSubReady.
- f) SgsnFunction.
- g) Valid for packet switching.
- h) GSM.

### 5.1.20.2.3 Max number of subscribers in READY state

- a) This measurement provides the maximum number of subscribers in READY state.
- b) SI.
- c) This measurement is obtained by sampling at a pre-defined interval the number of subscribers in READY state and then taking the maximum.
- d) A single integer value.



- e) MM.MaxNbrSubReady.
- f) SgsnFunction.
- g) Valid for packet switching.
- h) GSM.

## 5.1.21 UMTS subscribers state

### 5.1.21.1 Subscribers in PMM-IDLE state

#### 5.1.21.1.1 Number of subscribers in PMM-IDLE state

- a) This measurement provides the number of subscribers in PMM-IDLE state.
- b) GAUGE.
- c) Incremented at PS Signalling Connection Release (Iu Release), decremented at PS Detach or PS Signalling Connection Establish (Service Request).
- d) A single integer value.
- e) MM.NbrSubPmmIdle.
- f) SgsnFunction.
- g) Valid for packet switching.
- h) UMTS.

#### 5.1.21.1.2 Mean number of subscribers in PMM-IDLE state

- a) This measurement provides the mean number of subscribers in PMM-IDLE state.
- b) SI.
- c) This measurement is obtained by sampling at a pre-defined interval the number of subscribers in PMM-IDLE state and then taking the arithmetic mean.
- d) A single integer value.
- e) MM.MeanNbrSubPmmIdle.
- f) SgsnFunction.
- g) Valid for packet switching.
- h) UMTS.

#### 5.1.21.1.3 Max number of subscribers in PMM-IDLE state

- a) This measurement provides the maximum number of subscribers in PMM-IDLE state.
- b) SI.
- c) This measurement is obtained by sampling at a pre-defined interval the number of subscribers in PMM-IDLE state and then taking the maximum.
- d) A single integer value.
- e) MM.MaxNbrSubPmmIdle.
- f) SgsnFunction.

- g) Valid for packet switching.
- h) UMTS.

#### 5.1.21.2 Subscribers in PMM-CONNECTED state

##### 5.1.21.2.1 Number of subscribers in PMM-CONNECTED state

- a) This measurement provides the number of subscribers in PMM-CONNECTED state.
- b) GAUGE.
- c) Decrementated at PS Signalling Connection Release (Iu Release), Detach, PS Attach Reject or RAU Reject, incremented at PS Attach or PS Signalling Connection Establish (Service Request).
- d) A single integer value.
- e) MM.NbrSubPmmConnected
- f) SgsnFunction.
- g) Valid for packet switching.
- h) UMTS.

##### 5.1.21.2.2 Mean number of subscribers in PMM-CONNECTED state

- a) This measurement provides the mean number of subscribers in PMM-CONNECTED state.
- b) SI.
- c) This measurement is obtained by sampling at a pre-defined interval the number of subscribers in PMM-CONNECTED state and then taking the arithmetic mean.
- d) A single integer value.
- e) MM.MeanNbrSubPmmConnected.
- f) SgsnFunction.
- g) Valid for packet switching.
- h) UMTS.

##### 5.1.21.2.3 Max number of subscribers in PMM-CONNECTED state

- a) This measurement provides the maximum number of subscribers in PMM-CONNECTED state.
- b) SI.
- c) This measurement is obtained by sampling at a pre-defined interval the number of subscribers in PMM-CONNECTED state and then taking the maximum.
- d) A single integer value.
- e) MM.MaxNbrSubPmmConnected.
- f) SgsnFunction.
- g) Valid for packet switching.
- h) UMTS.

## 5.1.22 Attached subscribers

### 5.1.22.1 Number of attached subscribers

- a) This measurement provides the number of attached subscribers within this SGSN area. The three measurement types defined in e) are subject to the "2 out of 3 approach".
- b) GAUGE.
- c) Incremented when a subscriber enters the GMM\_REGISTERED state in the SGSN Location Register, and decremented when a subscriber leaves the GMM\_REGISTERED state.

NOTE: The GMM state machine in the SGSN Location Register is described in TS 24.008 [15], clause 4.1.3.3 (Figure 4.1c/3GPP TS 24.008: GMM main states on the network side).

- d) A single integer value per measurement type defined in e).
- e) MM.NbrActAttachedSub:
  - MM.NbrActAttachedSub Combined (don't care);
  - MM.NbrActAttachedSub.G GSM;
  - MM.NbrActAttachedSub.U UMTS.
- f) SgsnFunction.
- g) Valid for packet switching.
- h) GSM/UMTS.

### 5.1.22.2 Mean number of attached subscribers

- i) This measurement provides the mean number of attached subscribers within this SGSN area. The three measurement types defined in e) are subject to the "2 out of 3 approach".
- j) SI.
- k) This measurement is obtained by sampling at a pre-defined interval the number of attached subscribers and then taking the arithmetic mean.
- l) A single integer value per measurement type defined in e).
- m) MM.MeanNbrAttachedSub:
  - MM.MeanNbrAttachedSub Combined (don't care);
  - MM.MeanNbrAttachedSub.G GSM;
  - MM.MeanNbrAttachedSub.U UMTS.
- n) SgsnFunction.
- o) Valid for packet switching.
- p) GSM/UMTS.

### 5.1.22.3 Max number of attached subscribers

- i) This measurement provides the maximum number of attached subscribers within this SGSN area. The three measurement types defined in e) are subject to the "2 out of 3 approach".
- j) SI.

- k) This measurement is obtained by sampling at a pre-defined interval the number of attached subscribers and then taking the maximum.
- l) A single integer value per measurement type defined in e).
- m) MM.MaxNbrAttachedSub:
  - MM.MaxNbrAttachedSub Combined (don't care);
  - MM.MaxNbrAttachedSub.G GSM;
  - MM.MaxNbrAttachedSub.U UMTS.
- n) SgsnFunction.
- o) Valid for packet switching.
- p) GSM/UMTS.

## 5.1.23 Home subscribers

### 5.1.23.1 Number of home subscribers

- a) This measurement provides the number of GPRS home subscribers located in the SGSN location register. The GPRS MM state of this subscriber is GMM\_REGISTERED or GMM\_DEREGISTERED. Only GPRS subscribers that are homed in the same GPRS network are considered. The three measurement types defined in e) are subject to the "2 out of 3 approach".
- b) GAUGE.
- c) Incremented by one when GPRS home subscriber is successfully registered in the SGSN location register and decremented by one when GPRS home subscriber is successfully deregistered out of the SGSN location register (TS 24.008).
- d) A single integer value per measurement type defined in e).
- e) MM.NbrHomeSub:
  - MM.NbrHomeSub Combined (don't care);
  - MM.NbrHomeSub.G GSM;
  - MM.NbrHomeSub.U UMTS.
- f) SgsnFunction.
- g) Valid for packet switching.
- h) GSM/UMTS.

### 5.1.23.2 Mean number of home subscribers

- a) This measurement provides the mean number of GPRS home subscribers located in the SGSN location register. The three measurement types defined in e) are subject to the "2 out of 3 approach".
- b) SI.
- c) This measurement is obtained by sampling at a pre-defined interval the number of GPRS home subscribers located in the SGSN location register and then taking the arithmetic mean.
- d) A single integer value per measurement type defined in e).
- e) MM.MeanNbrHomeSub:
  - MM.MeanNbrHomeSub Combined (don't care);

- MM.MeanNbrHomeSub.G GSM;
  - MM.MeanNbrHomeSub.U UMTS.
- f) SgsnFunction.
- g) Valid for packet switching.
- h) GSM/UMTS.

### 5.1.23.3 Max number of home subscribers

- a) This measurement provides the maximum number of GPRS home subscribers located in the SGSN location register.  
The three measurement types defined in e) are subject to the "2 out of 3 approach".
- b) SI.
- c) This measurement is obtained by sampling at a pre-defined interval the number of GPRS home subscribers located in the SGSN location register and then taking the maximum.
- d) A single integer value per measurement type defined in e).
- e) MM.MaxNbrHomeSub:
- MM.MaxNbrHomeSub Combined (don't care);
  - MM.MaxNbrHomeSub.G GSM;
  - MM.MaxNbrHomeSub.U UMTS.
- f) SgsnFunction.
- g) Valid for packet switching.
- h) GSM/UMTS.

### 5.1.24 Visiting national subscribers

#### 5.1.24.1 Number of visiting national subscribers

- a) This measurement provides the number of visiting national GPRS subscribers located in the SGSN location register. The GPRS MM state of this subscriber is GMM\_REGISTERED or GMM\_DEREGISTERED. Only GPRS subscribers that are homed in a partner GPRS network of the same country are considered.  
The three measurement types defined in e) are subject to the "2 out of 3 approach".
- b) GAUGE.
- c) This measurement provides the number of visiting national GPRS subscribers located in the SGSN location register. The GPRS MM state of this subscriber is GMM\_REGISTERED or GMM\_DEREGISTERED. Only GPRS subscribers that are homed in a partner GPRS network of the same country are considered.
- d) A single integer value per measurement type defined in e).
- e) MM.NbrVisitingNatSub:
- MM.NbrVisitingNatSub Combined (don't care);
  - MM.NbrVisitingNatSub.G GSM;
  - MM.NbrVisitingNatSub.U UMTS.
- f) SgsnFunction.
- g) Valid for packet switching.

h) GSM/UMTS.

### 5.124.2 Mean number of visiting national subscribers

a) This measurement provides the mean number of visiting national GPRS subscribers located in the SGSN location register.

The three measurement types defined in e) are subject to the "2 out of 3 approach".

b) SI.

c) This measurement is obtained by sampling at a pre-defined interval the number of visiting national GPRS subscribers located in the SGSN location register and then taking the arithmetic mean.

d) A single integer value per measurement type defined in e).

e) MM.MeanNbrVisitingNatSub:

- MM.MeanNbrVisitingNatSub Combined (don't care);
- MM.MeanNbrVisitingNatSub.G GSM;
- MM.MeanNbrVisitingNatSub.U UMTS.

f) SgsnFunction.

g) Valid for packet switching.

h) GSM/UMTS.

### 5.1.24.3 Max number of visiting national subscribers

a) This measurement provides the maximum number of visiting national GPRS subscribers located in the SGSN location register.

The three measurement types defined in e) are subject to the "2 out of 3 approach".

b) SI.

c) This measurement is obtained by sampling at a pre-defined interval the number of visiting national GPRS subscribers located in the SGSN location register and then taking the maximum.

d) A single integer value per measurement type defined in e).

e) MM.MaxNbrVisitingNatSub:

- MM.MaxNbrVisitingNatSub Combined (don't care);
- MM.MaxNbrVisitingNatSub.G GSM;
- MM.MaxNbrVisitingNatSub.U UMTS.

f) SgsnFunction.

g) Valid for packet switching.

h) GSM/UMTS.

## 5.1.25 Visiting foreign subscribers

### 5.1.25.1 Number of visiting foreign subscribers

a) This measurement provides the number of visiting foreign GPRS located in the SGSN location register. The GPRS MM state of this subscriber is GMM\_REGISTERED or MM\_DEREGISTERED. Only GPRS subscribers that are homed in a GPRS network of a foreign country are considered.

The three measurement types defined in e) are subject to the "2 out of 3 approach".

- b) GAUGE.
- c) Incremented by one when GPRS subscriber is successfully registered in the SGSN location register and decremented by one when GPRS subscriber is successfully deregistered out of the SGSN location register (TS 24.008).
- d) A single integer value per measurement type defined in e).
- e) MM.NbrVisitingForeign:
  - MM.NbrVisitingForeign Combined (don't care);
  - MM.NbrVisitingForeign.G GSM;
  - MM.NbrVisitingForeign.U UMTS.
- f) SgsnFunction.
- g) Valid for packet switching.
- h) GSM/UMTS.

### 5.1.25.2 Mean number of visiting foreign subscribers

- a) This measurement provides the mean number of visiting foreign GPRS subscribers located in the SGSN location register.  
The three measurement types defined in e) are subject to the "2 out of 3 approach".
- b) SI.
- c) This measurement is obtained by sampling at a pre-defined interval the number of visiting foreign GPRS subscribers located in the SGSN location register and then taking the arithmetic mean.
- d) A single integer value per measurement type defined in e).
- e) MM.MeanNbrVisitingForeign:
  - MM.MeanNbrVisitingForeign Combined (don't care);
  - MM.MeanNbrVisitingForeign.G GSM;
  - MM.MeanNbrVisitingForeign.U UMTS.
- f) SgsnFunction.
- g) Valid for packet switching.
- h) GSM/UMTS.

### 5.1.25.3 Max number of visiting foreign subscribers

- a) This measurement provides the maximum number of visiting foreign GPRS subscribers located in the SGSN location register.  
The three measurement types defined in e) are subject to the "2 out of 3 approach".
- b) SI.
- c) This measurement is obtained by sampling at a pre-defined interval the number of visiting foreign GPRS subscribers located in the SGSN location register and then taking the maximum.
- d) A single integer value per measurement type defined in e).
- e) MM.MaxNbrVisitingForeign:
  - MM.MaxNbrVisitingForeign Combined (don't care);

- MM.MaxNbrVisitingForeign.G GSM;
- MM.MaxNbrVisitingForeign.U UMTS.

f) SgsnFunction.

g) Valid for packet switching.

h) GSM/UMTS.

### 5.1.26 Void

### 5.1.27 Void

### 5.1.28 Void

### 5.1.29 Void

## 5.1.30 CAMEL subscribers

### 5.1.30.1 Number of CAMEL subscribers

a) This measurement provides the number of attached subscriber within this SGSN area with CAMEL service. The three measurement types defined in e) are subject to the "2 out of 3 approach".

b) GAUGE.

c) Incremented when a CAMEL subscriber enters the GMM\_REGISTERED state in the SGSN Location Register, and decremented when a subscriber leaves the GMM\_REGISTERED state.

Note: the GMM state machine in the SGSN Location Register is described in 3GPP TS 24.008 [15], subclause 4.1.3.3 (Figure 4.1c/3GPP TS 24.008: GMM main states on the network side).

d) A single integer value per measurement type defined in e).

e) MM.NbrCamelSub:

- MM.NbrCamelSub Combined (don't care);
- MM.NbrCamelSub.G GSM;
- MM.NbrCamelSub.U UMTS.

f) SgsnFunction.

g) Valid for packet switching.

h) GSM/UMTS.

### 5.1.30.2 Mean Number of CAMEL subscribers

a) This measurement provides the mean number of attached subscribers with CAMEL service. The three measurement types defined in e) are subject to the "2 out of 3 approach".

b) SI.

c) This measurement is obtained by sampling at a pre-defined interval the number of attached subscribers with CAMEL service and then taking the arithmetic mean.

d) A single integer value per measurement type defined in e).



- e) MM.MeanNbrCamelSub:
  - MM.MeanNbrCamelSub Combined (don't care);
  - MM.MeanNbrCamelSub.G GSM;
  - MM.MeanNbrCamelSub.U UMTS.
- f) SgsnFunction.
- g) Valid for packet switching.
- h) GSM/UMTS.

### 5.1.30.3 Max number of CAMEL subscribers

- a) This measurement provides the maximum number of attached subscribers with CAMEL service. The three measurement types defined in e) are subject to the "2 out of 3 approach".
- b) SI.
- c) This measurement is obtained by sampling at a pre-defined interval the number of attached subscribers with CAMEL service and then taking the maximum.
- d) A single integer value per measurement type defined in e).
- e) MM.MaxNbrCamelSub:
  - MM.MaxNbrCamelSub Combined (don't care);
  - MM.MaxNbrCamelSub.G GSM;
  - MM.MaxNbrCamelSub.U UMTS.
- f) SgsnFunction.
- g) Valid for packet switching.
- h) GSM/UMTS.

### 5.1.31 Void

### 5.1.32 InsertSubscriberData requests received from a HLR during GPRS Update Location procedure

#### 5.1.32.1 Attempted InsertSubscriberData requests received from a HLR during GPRS Update Location procedure

- a) This measurement provides the number of InsertSubscriberData requests received from a HLR during GPRS Update Location procedure.
- b) CC.
- c) Receipt of a "MAP-INSERT-SUBSCRIBER-DATA" service request (TS 29.002) during a GPRS Update Location procedure.
- d) A single integer value.
- e) MM.AttInsertSubscrDataHlrUpdLoc.
- f) SgsnFunction.
- g) Valid for packet switching.

- h) Combined.

### 5.1.33 GPRS Update Locations sent to the HLR

#### 5.1.33.1 Attempted GPRS Update Locations sent to the HLR

- a) This measurement provides the number of GPRS Update Locations sent to the HLR.
- b) CC.
- c) Transmission of a 'MAP\_UPDATE\_LOCATION' service request (TS 29.002).
- d) A single integer value.
- e) MM.AttUpdateGprsLocationHlr.
- f) SgsnFunction.
- g) Valid for packet switching.
- h) Combined.

#### 5.1.33.2 Successful GPRS Update Locations returned from the HLR

- a) This measurement provides the number of successful GPRS Update Locations returned from the HLR.
- b) CC.
- c) Receipt of a 'MAP\_UPDATE\_LOCATION ack' service response/confirm indicating a successful GPRS Update location (TS 29.002).
- d) A single integer value.
- e) MM.SuccUpdateGprsLocationHlr.
- f) SgsnFunction.
- g) Valid for packet switching.
- h) Combined.

### 5.1.34 CancelLocation requests received from an HLR-operator, in case of a HLR-initiated Detach

#### 5.1.34.1 Attempted CancelLocation requests received from an HLR-operator, in case of a HLR-initiated Detach

- a) This measurement provides the number of CancelLocation requests received from an HLR-operator, in case of a HLR-initiated Detach.
- b) CC.
- c) Receipt of a 'MAP\_CANCEL\_LOCATION' service request (TS 29.002).
- d) A single integer value.
- e) MM.AttCancelLocHlrOp.
- f) SgsnFunction.
- g) Valid for packet switching.
- h) Combined.

### 5.1.35 CancelLocation requests received from a HLR due to a SGSN-change (previous SGSN)

#### 5.1.35.1 Attempted CancelLocation requests received from a HLR due to a SGSN-change (previous SGSN)

- a) This measurement provides the number of CancelLocation requests received from a HLR due to a SGSN-change(previous SGSN).
- b) CC.
- c) Receipt of a 'MAP\_CANCEL\_LOCATION' service request (TS 29.002) due to a SGSN-change (previous SGSN).
- d) A single integer value.
- e) MM.AttCancelLocHlrSgsnChg.
- f) SgsnFunction.
- g) Valid for packet switching.
- h) Combined.

### 5.1.36 Reset requests received from a HLR due to an HLR restart, indicating that a failure occurred

#### 5.1.36.1 Attempted Reset requests received from a HLR due to an HLR restart, indicating that a failure occurred

- a) This measurement provides the number of Reset requests received from a HLR due to an HLR restart, indicating that a failure occurred.
- b) CC.
- c) Receipt of a 'MAP\_RESET' service request (TS 29.002) from a HLR.
- d) A single integer value.
- e) MM.AttResetHlr.
- f) SgsnFunction.
- g) Valid for packet switching.
- h) Combined.

## 5.2 Subscriber Management

### 5.2.1 Insert Subscriber Data requests received from a HLR due to an HLR-operator intervention

#### 5.2.1.1 Attempted Insert Subscriber Data requests received from a HLR due to an HLR-operator intervention

- a) This measurement provides the number of Insert Subscriber Data requests received from a HLR due to an HLR-operator intervention.  
The three measurement types defined in e) are subject to the "2 out of 3 approach".

- b) CC.
- c) Receipt of a "MAP-INSERT-SUBSCRIBER-DATA" service request (TS 29.002).
- d) A single integer value per measurement type defined in e).
- e) SUB.AttInsertSubscrDataHlrOp:
  - SUB.AttInsertSubscrDataHlrOp Combined (don't care);
  - SUB.AttInsertSubscrDataHlrOp.G GSM;
  - SUB.AttInsertSubscrDataHlrOp.U UMTS.
- f) SgsnFunction.
- g) Valid for packet switching.
- h) GSM/UMTS.

## 5.2.2 Delete Subscriber Data requests received from a HLR due to an HLR-operator intervention

### 5.2.2.1 Attempted Delete Subscriber Data requests received from a HLR due to an HLR-operator intervention

- a) This measurement provides the number of Delete Subscriber Data requests received from a HLR due to an HLR-operator intervention.  
The three measurement types defined in e) are subject to the "2 out of 3 approach".
- b) CC.
- c) Receipt of a "MAP\_DELETE\_SUBSCRIBER\_DATA" service request (TS 29.002).
- d) A single integer value per measurement type defined in e).
- e) SUB.AttDeleteSubscrDataHlrOp:
  - SUB.AttDeleteSubscrDataHlrOp Combined (don't care);
  - SUB.AttDeleteSubscrDataHlrOp.G GSM;
  - SUB.AttDeleteSubscrDataHlrOp.U UMTS.
- f) SgsnFunction.
- g) Valid for packet switching.
- h) GSM/UMTS.

## 5.3 SRNS Relocation

### 5.3.1 Intra 3G-SGSN SRNS Relocations

The four measurements defined in the clause 5.3.1 are subject to the "3 out of 4 approach".

NOTE: Number of Attempted intra 3G-SGSN SRNS Relocations = Number of Successful intra 3G-SGSN SRNS Relocations + Number of Failed intra 3G-SGSN SRNS Relocations, due to internal reasons + Number of Failed intra 3G-SGSN SRNS Relocations, due to external reasons.

### 5.3.1.1 Attempted intra 3G-SGSN SRNS Relocations

- a) This measurement provides the number of attempts intra 3G-SGSN SRNS Relocations.
- b) CC.
- c) Receipt of "Relocation Required" message (TS 25.413 [5]) from SRNC, where the Target ID indicates Intra SGSN SRNS Relocation.
- d) A single integer value.
- e) RELOC.AttIntraSGSN.
- f) SgsnFunction.
- g) Valid for packet switching.
- h) UMTS.

### 5.3.1.2 Successful intra 3G-SGSN SRNS Relocations

- a) This measurement provides the number of successful intra 3G-SGSN SRNS Relocations.
- b) CC.
- c) Receipt of "Relocation Complete" message for intra 3G-SGSN SRNS Relocation (TS 25.413 [5]) from TRNC.
- d) A single integer value.
- e) RELOC.SuccIntraSGSN.
- f) SgsnFunction.
- g) Valid for packet switching.
- h) UMTS.

### 5.3.1.3 Failed intra 3G-SGSN SRNS Relocations, due to internal reasons

- a) This measurement provides the number of failed intra 3G-SGSN SRNS Relocations, due to internal reasons.
- b) CC.
- c) Intra 3G-SGSN SRNS Relocation fails due to reasons located inside this SGSN:- internal resource problem-recovery- ...
- d) A single integer value.
- e) RELOC.FailIntraSGSNInt.
- f) SgsnFunction.
- g) Valid for packet switching.
- h) UMTS.

### 5.3.1.4 Failed intra 3G-SGSN SRNS Relocations, due to external reasons

- a) This measurement provides the number of failed intra 3G-SGSN SRNS Relocations, due to external reasons.
- b) CC.
- c) Intra 3G-SGSN SRNS Relocation fails due to reasons located in NE outside this SGSN:- "Relocation Preparation Failure" (TS 25.413 [5]) is sent to the SRNC- "Relocation Failure" (TS 25.413 [5]) is received from the TRNC- "Relocation Cancel" (TS 25.413 [5]) is received from the SRNC- missing expected message from RNC (timer expiry)- ...

- d) A single integer value.
- e) RELOC.FailIntraSGSNext.
- f) SgsnFunction.
- g) Valid for packet switching.
- h) UMTS.

### 5.3.2 Inter 3G-SGSN SRNS Relocations

The four measurements defined in the clause 5.3.2 are subject to the "3 out of 4 approach".

NOTE: Number Attempted inter 3G-SGSN SRNS Relocations, counted in the old 3G-SGSN = Number of Successful inter 3G-SGSN SRNS Relocations, counted in the old 3G-SGSN + Number of Failed inter 3G-SGSN SRNS Relocations, due to external reasons, counted in the old 3G-SGSN + Number of Failed inter 3G-SGSN SRNS Relocations, due to external reasons, counted in the old 3G-SGSN.

#### 5.3.2.1 Attempted inter 3G-SGSN SRNS Relocations, counted in the old 3G-SGSN

- a) This measurement provides the number of attempted inter 3G-SGSN SRNS Relocations.
- b) CC.
- c) Receipt of "Relocation Required" message (TS 25.413 [5]) from SRNC, where the Target ID indicates Inter SGSN SRNS Relocation.
- d) A single integer value.
- e) RELOC.AttInterSGSN.
- f) SgsnFunction.
- g) Valid for packet switching.
- h) UMTS.

#### 5.3.2.2 Successful inter 3G-SGSN SRNS Relocations, counted in the old 3G-SGSN

- a) This measurement provides the number of successful Inter 3G-SGSN SRNS Relocations, counted in the old 3G-SGSN.
- b) CC.
- c) Receipt of "Forward Relocation Complete" message (TS 29.060) from the new SGSN.
- d) A single integer value.
- e) RELOC.SuccInterSGSN.
- f) SgsnFunction.
- g) Valid for packet switching.
- h) UMTS.

#### 5.3.2.3 Failed inter 3G-SGSN SRNS Relocations, due to internal reasons, counted in the old 3G-SGSN

- a) This measurement provides the number of failed Inter 3G-SGSN SRNS Relocations, due to internal reasons.
- b) CC.

- c) Inter 3G-SGSN SRNS Relocation fails due to reasons located inside this SGSN:- internal resource problem-recovery- ...
- d) A single integer value.
- e) RELOC.FailInterSGSNInt.
- f) SgsnFunction.
- g) Valid for packet switching.
- h) UMTS.

#### 5.3.2.4 Failed inter 3G-SGSN SRNS Relocations, due to external reasons, counted in the old 3G-SGSN

- a) This measurement provides the number of failed Inter 3G-SGSN SRNS Relocations, due to external reasons.
- b) CC.
- c) Inter 3G-SGSN SRNS Relocation fails due to reasons located in NE outside this SGSN:- the Cause in "Forward Relocation Response" (TS 29.060) from the new 3G-SGSN is not "Request Accepted"- "Relocation Preparation Failure" (TS 25.413 [5]) is sent to the SRNC- "Relocation Failure" (TS 25.413 [5]) is received from the TRNC- "Relocation Cancel" (TS 25.413 [5]) is received from the SRNC- missing expected message from RNC or new 3G-SGSN (timer expiry)- ...
- d) A single integer value.
- e) RELOC.FailInterSGSNExt.
- f) SgsnFunction.
- g) Valid for packet switching.
- h) UMTS.

### 5.3.3 Inter 3G-SGSN SRNS Relocations, counted in the new 3G-SGSN

#### 5.3.3.1 Attempted inter 3G-SGSN SRNS Relocations, counted in the new 3G-SGSN

- a) This measurement provides the number of attempted inter 3G-SGSN SRNS Relocations, counted in the new 3G-SGSN.
- b) CC.
- c) Receipt of "Forward Relocation Request" message (TS 29.060) from the old SGSN.
- d) A single integer value.
- e) RELOC.AttInterSGSNNew.
- f) SgsnFunction.
- g) Valid for packet switching.
- h) UMTS.

#### 5.3.3.2 Successful Inter 3G-SGSN SRNS Relocations, counted in the new 3G-SGSN

- a) This measurement provides the number of successful Inter 3G-SGSN SRNS Relocations, counted in the new 3G-SGSN.
- b) CC.

- c) Transmission of "Forward Relocation Complete" message (TS 29.060) to the old SGSN.
- d) A single integer value.
- e) RELOC.SuccInterSGSNNew.
- f) SgsnFunction.
- g) Valid for packet switching.
- h) UMTS.

## 5.4 Security

### 5.4.1 P-TMSI reallocation procedures

#### 5.4.1.1 Attempted P-TMSI reallocation procedures

- a) This measurement provides the number of attempted P-TMSI reallocation, or implicitly as part of the Location Updating, procedures in this SGSN.  
The three measurement types defined in e) are subject to the "2 out of 3 approach".
- b) CC.
- c) Transmission of "P-TMSI REALLOCATION COMMAND" message by the SGSN (TS 24.008).
- d) A single integer value per measurement type defined in e).
- e) SEC.AttPTMSIRealloc:
  - SEC.AttPTMSIRealloc Combined (don't care);
  - SEC.AttPTMSIRealloc.G GSM;
  - SEC.AttPTMSIRealloc.U UMTS.
- f) SgsnFunction.
- g) Valid for packet switching.
- h) GSM/UMTS.

#### 5.4.1.2 Successful P-TMSI reallocation procedures

- a) This measurement provides the number of successfully performed P-TMSI reallocation procedures in this SGSN.  
The three measurement types defined in e) are subject to the "2 out of 3 approach".
- b) CC.
- c) Receipt of "P-TMSI REALLOCATION COMPLETE" message by the SGSN (TS 24.008).
- d) A single integer value per measurement type defined in e).
- e) SEC.SuccPTMSIRealloc:
  - SEC.SuccPTMSIRealloc Combined (don't care);
  - SEC.SuccPTMSIRealloc.G GSM;
  - SEC.SuccPTMSIRealloc.U UMTS.
- f) SgsnFunction.



- g) Valid for packet switching.
- h) GSM/UMTS.

## 5.4.2 Identity Request procedures initiated by this SGSN

### 5.4.2.1 Attempted Identity Request procedures initiated by this SGSN

- a) This measurement provides the number of attempted Identity Request procedures initiated by this SGSN. The three measurement types defined in e) are subject to the "2 out of 3 approach".
- b) CC.
- c) Transmission of an "IDENTITY REQUEST" (with Identity Type = IMSI) message to the MS (TS 24.008).
- d) A single integer value per measurement type defined in e).
- e) SEC.AttIdentityReqImsi:
  - SEC.AttIdentityReqImsi Combined (don't care);
  - SEC.AttIdentityReqImsi.G GSM;
  - SEC.AttIdentityReqImsi.U UMTS.
- f) SgsnFunction.
- g) Valid for packet switching.
- h) GSM/UMTS.

### 5.4.2.2 Successful completed Identity Request procedures initiated by this SGSN

- a) This measurement provides the number of successfully completed Identity Request procedures initiated by this SGSN. The three measurement types defined in e) are subject to the "2 out of 3 approach".
- b) CC.
- c) Receipt of an "IDENTITY RESPONSE" message with IMSI by the SGSN from the MS (TS 24.008).
- d) A single integer value per measurement type defined in e).
- e) SEC.SuccIdentityReqImsi:
  - SEC.SuccIdentityReqImsi Combined (don't care);
  - SEC.SuccIdentityReqImsi.G GSM;
  - SEC.SuccIdentityReqImsi.U UMTS.
- f) SgsnFunction.
- g) Valid for packet switching.
- h) GSM/UMTS.

### 5.4.3 Identification information requests sent to a partner (previous) SGSN for subscribers registering afresh in this SGSN

#### 5.4.3.1 Attempted identification information requests sent to a partner (previous) SGSN for subscribers registering afresh in this SGSN

- a) This measurement provides the number of identification information requests sent to a partner (previous) SGSN for subscribers registering afresh in this SGSN.  
The three measurement types defined in e) are subject to the "2 out of 3 approach".
- b) CC.
- c) Transmission of the "Identification Request" message to the old SGSN (TS 29.060).
- d) A single integer value per measurement type defined in e).
- e) SEC.AttIdentityReqToPsgsn:
  - SEC.AttIdentityReqToPsgsn Combined (don't care);
  - SEC.AttIdentityReqToPsgsn.G GSM;
  - SEC.AttIdentityReqToPsgsn.U UMTS.
- f) SgsnFunction.
- g) Valid for packet switching.
- h) GSM/UMTS.

#### 5.4.3.2 Successful replied identification information requests that were sent to a partner (previous) SGSN

- a) This measurement provides the number of successfully replied identification information requests that were sent to a partner (previous) SGSN.  
The three measurement types defined in e) are subject to the "2 out of 3 approach".
- b) CC.
- c) Receipt of the "Identification Response" message from the old SGSN (TS 29.060).
- d) A single integer value per measurement type defined in e).
- e) SEC.SuccIdentityReqToPsgsn:
  - SEC.SuccIdentityReqToPsgsn Combined (don't care);
  - SEC.SuccIdentityReqToPsgsn.G GSM;
  - SEC.SuccIdentityReqToPsgsn.U UMTS.
- f) SgsnFunction.
- g) Valid for packet switching.
- h) GSM/UMTS.

## 5.4.4 Attempted Identity Requests sent to the MS

### 5.4.4.1 Attempted Identity Requests sent to the MS

- a) This measurement provides the number of Identity Requests sent to the MS.  
The three measurement types defined in e) are subject to the "2 out of 3 approach".
- b) CC.
- c) Transmission of an "IDENTITY REQUEST" message (TS 24.008).
- d) A single integer value per measurement type defined in e).
- e) SEC.AttIdentityRequest:
  - SEC.AttIdentityRequest Combined (don't care);
  - SEC.AttIdentityRequest.G GSM;
  - SEC.AttIdentityRequest.U UMTS.
- f) SgsnFunction.
- g) Valid for packet switching.
- h) GSM/UMTS.

### 5.4.4.2 Successful replied Identity Requests from the MS

- a) This measurement provides the number of successfully replied Identity Requests from the MS.  
The three measurement types defined in e) are subject to the "2 out of 3 approach".
- b) CC.
- c) Receipt of an "IDENTITY RESPONSE" message (TS 24.008) from the MS.
- d) A single integer value per measurement type defined in e).
- e) SEC.SuccIdentityRequest:
  - SEC.SuccIdentityRequest Combined (don't care);
  - SEC.SuccIdentityRequest.G GSM;
  - SEC.SuccIdentityRequest.U UMTS.
- f) SgsnFunction.
- g) Valid for packet switching.
- h) GSM/UMTS.

## 5.4.5 Authentication procedures that are started within this SGSN area for a subscriber using a SIM

### 5.4.5.1 Attempted authentication procedures that are started within this SGSN area for a subscriber using a SIM

- a) This measurement provides the number of authentication procedures that are started within this SGSN area for a subscriber using a SIM.  
The three measurement types defined in e) are subject to the "2 out of 3 approach".
- b) CC.

- c) Transmission of an "AUTHENTICATION AND CIPHERING REQUEST" message to a MS using a SIM (TS 24.008).
- d) A single integer value per measurement type defined in e).
- e) SEC.AttAuthProcsSgsnSim:
  - SEC.AttAuthProcsSgsnSim Combined (don't care);
  - SEC.AttAuthProcsSgsnSim.G GSM;
  - SEC.AttAuthProcsSgsnSim.U UMTS.
- f) SgsnFunction.
- g) Valid for packet switching.
- h) GSM/UMTS.

#### 5.4.5.2 Successful authentication procedures within this SGSN area, for a subscriber using a SIM

- a) This measurement provides the number of successful authentication procedures within this SGSN area, for a subscriber using a SIM.  
The three measurement types defined in e) are subject to the "2 out of 3 approach".
- b) CC.
- c) Receipt of an "AUTHENTICATION AND CIPHERING RESPONSE" message from the MS, using a SIM, where the receipt SRES parameter value matches the value stored in the SGSN (TS 24.008).
- d) A single integer value per measurement type defined in e).
- e) SEC.SuccAuthProcsSgsnSim:
  - SEC.SuccAuthProcsSgsnSim Combined (don't care);
  - SEC.SuccAuthProcsSgsnSim.G GSM;
  - SEC.SuccAuthProcsSgsnSim.U UMTS.
- f) SgsnFunction.
- g) Valid for packet switching.
- h) GSM/UMTS.

#### 5.4.6 Authentication procedures that are started within this SGSN area for a subscriber using a USIM

##### 5.4.6.1 Attempted authentication procedures that are started within this SGSN area for a subscriber using a USIM

- a) This measurement provides the number of authentication procedures that are started within this SGSN area for a subscriber using a USIM.  
The three measurement types defined in e) are subject to the "2 out of 3 approach".
- b) CC.
- c) Transmission of an "AUTHENTICATION AND CIPHERING REQUEST" message to a MS using a USIM (TS 24.008).
- d) A single integer value per measurement type defined in e).

- e) SEC.AttAuthProcsSgsnUsim:
  - SEC.AttAuthProcsSgsnUsim Combined (don't care);
  - SEC.AttAuthProcsSgsnUsim.G GSM;
  - SEC.AttAuthProcsSgsnUsim.U UMTS.
- f) SgsnFunction.
- g) Valid for packet switching.
- h) GSM/UMTS.

#### 5.4.6.2 Successful authentication procedures within this SGSN area, for a subscriber using a USIM

- a) This measurement provides the number of successful authentication procedures within this SGSN area, for a subscriber using a USIM.  
The three measurement types defined in e) are subject to the "2 out of 3 approach".
- b) CC.
- c) Receipt of an "AUTHENTICATION AND CIPHERING RESPONSE" message from the MS , using a USIM, where the receipt RES parameter value matches the value stored in the SGSN (TS 24.008).
- d) A single integer value per measurement type defined in e).
- e) SEC.SuccAuthProcsSgsnUsim:
  - SEC.SuccAuthProcsSgsnUsim Combined (don't care);
  - SEC.SuccAuthProcsSgsnUsim.G GSM;
  - SEC.SuccAuthProcsSgsnUsim.U UMTS.
- f) SgsnFunction.
- g) Valid for packet switching.
- h) GSM/UMTS.

#### 5.4.6.3 Received ciphering and Authentication failures within this SGSN area

- a) This measurement provides the number of ciphering and Authentication failures within this SGSN area.  
The three measurement types defined in e) are subject to the "2 out of 3 approach".
- b) CC.
- c) Receipt of an "AUTHENTICATION AND CIPHERING FAILURE" message from the MS (TS 24.008).
- d) A single integer value per measurement type defined in e).
- e) SEC.RecPOAuthFailSgsn:
  - SEC.RecPOAuthFailSgsn Combined (don't care);
  - SEC.RecPOAuthFailSgsn.G GSM;
  - SEC.RecPOAuthFailSgsn.U UMTS.
- f) SgsnFunction.
- g) Valid for packet switching.
- h) GSM/UMTS.

## 5.4.7 Identification information requests that were received from a partner (new) SGSN for subscribers de-registering from this SGSN

### 5.4.7.1 Attempted identification information requests that were received from a partner (new) SGSN for subscribers de-registering from this SGSN

- a) This measurement provides the number of identification information requests that were received from a partner (new) SGSN for subscribers de-registering from this SGSN.  
The three measurement types defined in e) are subject to the "2 out of 3 approach".
- b) CC.
- c) Receipt of the "Identification Request" message from a partner (new) SGSN (TS 29.060).
- d) A single integer value per measurement type defined in e).
- e) SEC.AttIdentityReqFromPsgsn:
  - SEC.AttIdentityReqFromPsgsn Combined (don't care);
  - SEC.AttIdentityReqFromPsgsn.G GSM;
  - SEC.AttIdentityReqFromPsgsn.U UMTS.
- f) SgsnFunction.
- g) Valid for packet switching.
- h) GSM/UMTS.

### 5.4.7.2 Successfully replied identification information requests that were received from a partner (new) SGSN

- a) This measurement provides the number of successfully replied identification information requests that were received from a partner (new) SGSN.  
The three measurement types defined in e) are subject to the "2 out of 3 approach".
- b) CC.
- c) Transmission of the "Identification Response" message to the new SGSN (TS 29.060).
- d) A single integer value per measurement type defined in e).
- e) SEC.SuccIdentityReqFromPsgsn:
  - SEC.SuccIdentityReqFromPsgsn Combined (don't care);
  - SEC.SuccIdentityReqFromPsgsn.G GSM;
  - SEC.SuccIdentityReqFromPsgsn.U UMTS.
- f) SgsnFunction.
- g) Valid for packet switching.
- h) GSM/UMTS.

## 5.4.8 SGSN context requests sent to a partner (previous) SGSN for subscribers registering afresh in this SGSN

### 5.4.8.1 Attempted SGSN context requests sent to a partner (previous) SGSN for subscribers registering afresh in this SGSN

- a) This measurement provides the number of SGSN context requests sent to a partner (previous) SGSN for subscribers registering afresh in this SGSN.  
The three measurement types defined in e) are subject to the "2 out of 3 approach".
- b) CC.
- c) Transmission of the "Context Request" message to the previous SGSN (TS 29.060).
- d) A single integer value per measurement type defined in e).
- e) SEC.AttContextRequestToPsgsn:
  - SEC.AttContextRequestToPsgsn Combined (don't care);
  - SEC.AttContextRequestToPsgsn.G GSM;
  - SEC.AttContextRequestToPsgsn.U UMTS.
- f) SgsnFunction.
- g) Valid for packet switching.
- h) GSM/UMTS.

### 5.4.8.2 Successfully replied SGSN context requests that were sent to a partner (previous) SGSN

- a) This measurement provides the number of successfully replied SGSN context requests that were sent to a partner (previous) SGSN.  
The three measurement types defined in e) are subject to the "2 out of 3 approach".
- b) CC.
- c) Receipt of the "Context Response" message from the previous SGSN (TS 29.060).
- d) A single integer value per measurement type defined in e).
- e) SEC.SuccContextRequestToPsgsn:
  - SEC.SuccContextRequestToPsgsn Combined (don't care);
  - SEC.SuccContextRequestToPsgsn.G GSM;
  - SEC.SuccContextRequestToPsgsn.U UMTS.
- f) SgsnFunction.
- g) Valid for packet switching.
- h) GSM/UMTS.

## 5.4.9 SGSN context requests received from a partner (new) SGSN for a subscriber de-registering from this SGSN

### 5.4.9.1 Attempted SGSN context requests received from a partner (new) SGSN for a subscriber de-registering from this SGSN

- a) This measurement provides the number of SGSN context requests received from a partner (new) SGSN for a subscriber de-registering from this SGSN.  
The three measurement types defined in e) are subject to the "2 out of 3 approach".
- b) CC.
- c) Receipt of the "Context Request" message from the new SGSN (TS 29.060).
- d) A single integer value per measurement type defined in e).
- e) SEC.AttContextRequestFromPsgsn:
  - SEC.AttContextRequestFromPsgsn Combined (don't care);
  - SEC.AttContextRequestFromPsgsn.G GSM;
  - SEC.AttContextRequestFromPsgsn.U UMTS.
- f) SgsnFunction.
- g) Valid for packet switching.
- h) GSM/UMTS.

### 5.4.9.2 Successfully replied SGSN context requests received from a partner (new) SGSN

- a) This measurement provides the number of successfully replied SGSN context requests received from a partner (new) SGSN.  
The three measurement types defined in e) are subject to the "2 out of 3 approach".
- b) CC.
- c) Transmission of the "Context Response" message to the new SGSN (TS 29.060).
- d) A single integer value per measurement type defined in e).
- e) SEC.SuccContextRequestFromPsgsn:
  - SEC.SuccContextRequestFromPsgsn Combined (don't care);
  - SEC.SuccContextRequestFromPsgsn.G GSM;
  - SEC.SuccContextRequestFromPsgsn.U UMTS.
- f) SgsnFunction.
- g) Valid for packet switching.
- h) GSM/UMTS.

## 5.4.10 Number of P-TMSI - IMSI correlation failures (User Identity Confidentiality (TS 23.060))

- a) This measurement provides the number of P-TMSI - IMSI correlation failures (User Identity Confidentiality (TS 23.060)).
- b) CC.



- c) This counter is triggered before the handling of the "Security Functions" (TS 23.060), in case of "Attach Request", "Routing Area Update Request", or "Service Request": if the correlation between the received P-TMSI and the stored IMSI is not valid then this counter is incremented.
- d) A single integer value.
- e) SEC.NbrPTMSICorrFailRnc.
- f) SgsnFunction.
- g) Valid for packet switching.
- h) UMTS.

## 5.4.11 Security mode control procedures started by the SGSN

### 5.4.11.1 Attempted security mode control procedures started by the SGSN

- a) This measurement provides the number of security mode control procedures started by the SGSN.
- b) CC.
- c) Transmission of a "SECURITY MODE COMMAND" message to the MS (TS 25.413 [5]).
- d) A single integer value.
- e) SEC.AttSecMode.
- f) SgsnFunction.
- g) Valid for packet switching.
- h) UMTS.

### 5.4.11.2 Successful security mode procedures

- a) This measurement provides the number of successful security mode procedures. The Security mode command response from MS starts the uplink integrity protection (and possible ciphering), i.e. also all following messages sent from the MS are integrity protected (and possibly ciphered).
- b) CC.
- c) Receipt of a "SECURITY MODE COMPLETE" message from the MS (TS 25.413 [5]).
- d) A single integer value.
- e) SEC.SuccSecMode.
- f) SgsnFunction.
- g) Valid for packet switching.
- h) UMTS.

## 5.4.12 Ciphering procedures started by the SGSN

### 5.4.12.1 Attempted GSM ciphering procedures started by the SGSN

- a) This measurement provides the number of GSM ciphering procedures started by the SGSN.
- b) CC.
- c) Transmission of an "AUTHENTICATION AND CIPHERING REQUEST" message with ciphering activated ("Ciphering algorithm" is not "ciphering not used (0)") to the MS (TS 24.008).

- d) A single integer value.
- e) SEC.AttGsmCipherring.
- f) SgsnFunction.
- g) Valid for packet switching.
- h) GSM.

#### 5.4.12.2 Successful GSM cipherring procedures started by the SGSN

- a) This measurement provides the number of successful GSM cipherring procedures started by the SGSN.
- b) CC.
- c) Receipt of an "AUTHENTICATION AND CIPHERING RESPONSE" message with cipherring activated from the MS (TS 24.008).
- d) A single integer value.
- e) SEC.SuccGsmCipherring.
- f) SgsnFunction.
- g) Valid for packet switching.
- h) GSM.

#### 5.4.12.3 Attempted UMTS cipherring procedures started by the SGSN

- a) This measurement provides the number of UMTS cipherring procedures started by the SGSN.
- b) CC.
- c) Transmission of a "SECURITY MODE COMMAND" message with cipherring activated ("Encryption Algorithm" is not "no encryption (0)") to the MS (TS 25.413 [5]).
- d) A single integer value.
- e) SEC.AttUmtsCipherring.
- f) SgsnFunction.
- g) Valid for packet switching.
- h) UMTS.

#### 5.4.12.4 Successful UMTS cipherring procedures started by the SGSN

- a) This measurement provides the number of successful UMTS cipherring procedures started by the SGSN.
- b) CC.
- c) Receipt of a "SECURITY MODE COMPLETE" message with cipherring activated from the MS (TS 25.413 [5]).
- d) A single integer value.
- e) SEC.SuccUmtsCipherring.
- f) SgsnFunction.
- g) Valid for packet switching.
- h) UMTS.

## 5.4.13 MAP V1 requests for authentication sets

### 5.4.13.1 Attempted MAP V1 requests for authentication sets, sent to the HLR by SGSN

- a) This measurement provides the number of attempted MAP V1 requests for authentication sets, sent to the HLR by SGSN.
- b) CC.
- c) Transmission of a "MAP V1 SEND\_AUTHENTICATION\_INFO" service request, requesting authentication sets present (TS 29.002).
- d) A single integer value.
- e) SEC.AttReqAuthSetsHlrV1.
- f) SgsnFunction.
- g) Valid for packet switching.
- h) Combined.

### 5.4.13.2 Successful MAP V1 requests for authentication sets that were sent to the HLR

- a) This measurement provides the number of successful MAP V1 requests for authentication sets that were sent to the HLR.
- b) CC.
- c) Receipt of a "MAP V1 SEND\_AUTHENTICATION\_INFO" service confirmation, containing requested authentication sets (parameter "AuthenticationSetList" present TS 29.002).
- d) A single integer value.
- e) SEC.SuccReqAuthSetsHlrV1.
- f) SgsnFunction.
- g) Valid for packet switching.
- h) Combined.

### 5.4.13.3 Number of empty responses to the MAP V1 request for authentication sets that were sent to the HLR

- a) This measurement provides the number of empty responses to the MAP V1 request for authentication sets that were sent to the HLR.
- b) CC.
- c) Receipt of a MAP V1 "SEND\_AUTHENTICATION\_INFO\_ACK" service confirmation, no Authentication sets present (TS 29.002).
- d) A single integer value.
- e) SEC.NbrEmptyRespAuthSetsHlrV1.
- f) SgsnFunction.
- g) Valid for packet switching.
- h) Combined.

## 5.4.14 MAP V3 requests for Authentication sets

### 5.4.14.1 Attempted MAP V3 requests for Authentication sets sent to the HLR by SGSN

- a) This measurement provides the number of attempted MAP V3 requests for Authentication sets sent to the HLR by SGSN.
- b) CC.
- c) Transmission of a MAP V3 "SEND\_AUTHENTICATION\_INFO" service request, requesting authentication sets present (TS 29.002).
- d) A single integer value.
- e) SEC.AttReqAuthSetsHlrV3.
- f) SgsnFunction.
- g) Valid for packet switching.
- h) Combined.

### 5.4.14.2 Successful MAP V3 requests for authentication sets that were sent to the HLR

- a) This measurement provides the number of successful MAP V3 requests for authentication sets that were sent to the HLR.
- b) CC.
- c) Receipt of a MAP V3 "SEND\_AUTHENTICATION\_INFO" service confirmation, containing requested authentication sets (parameter "AuthenticationSetList" present TS 29.002).
- d) A single integer value.
- e) SEC.SuccReqAuthSetsHlrV3.
- f) SgsnFunction.
- g) Valid for packet switching.
- h) Combined.

### 5.4.14.3 Number of empty responses to the MAP V3 request for authentication sets that were sent to the HLR

- a) This measurement provides the number of empty responses to the MAP V3 request for authentication sets that were sent to the HLR.
- b) CC.
- c) Receipt of a MAP V3 "SEND\_AUTHENTICATION\_INFO\_ACK" service confirmation, no Authentication sets present (TS 29.002).
- d) A single integer value.
- e) SEC.NbrEmptyRespAuthSetsHlrV3.
- f) SgsnFunction.
- g) Valid for packet switching.
- h) Combined.

## 5.5 SMS

The three measurement groups defined in subclause 5.5.n are subject to the "2 out of 3 approach".

### 5.5.1 SMS in the CS domain (MSC)

Up to now, no counters are defined for the failure cases. FFS.

#### 5.5.1.1 CS SMS mobile originating

##### 5.5.1.1.1 Attempted CS SMS mobile originating

- a) This measurement provides the number of CS SMS mobile originating attempts.  
The three measurement types defined in e) are subject to the "2 out of 3 approach".
- b) CC.
- c) Receipt by the MSC of "RP-DATA" Message (TS 24.011) from the MS.
- d) A single integer value per measurement type defined in e).
- e) SMS.AttMoCS:
  - SMS.AttMoCS Combined (don't care);
  - SMS.AttMoCS.G GSM;
  - SMS.AttMoCS.U UMTS.
- f) MscFunction.
- g) Valid for circuit switching.
- h) GSM/UMTS.

##### 5.5.1.1.2 Successful CS SMS mobile originating

- a) This measurement provides the number of successful CS SMS mobile originating attempts.  
The three measurement types defined in e) are subject to the "2 out of 3 approach".
- b) CC.
- c) Transmission by the MSC of "RP-ACK" Message (TS 24.011) to the MS.
- d) A single integer value per measurement type defined in e).
- e) SMS.SuccMoCS:
  - SMS.SuccMoCS Combined (don't care);
  - SMS.SuccMoCS.G GSM;
  - SMS.SuccMoCS.U UMTS.
- f) MscFunction.
- g) Valid for circuit switching.
- h) GSM/UMTS.

## 5.5.1.2 CS SMS mobile terminating

### 5.5.1.2.1 Attempted CS SMS mobile terminating

- a) This measurement provides the number of CS SMS mobile terminating attempts.  
The three measurement types defined in e) are subject to the "2 out of 3 approach".
- b) CC.
- c) Transmission by the MSC of "RP-DATA" Message (TS 24.011).
- d) A single integer value per measurement type defined in e).
- e) SMS.AttMtCS:
  - SMS.AttMtCS Combined (don't care);
  - SMS.AttMtCS.G GSM;
  - SMS.AttMtCS.U UMTS.
- f) MscFunction.
- g) Valid for circuit switching.
- h) GSM/UMTS.

### 5.5.1.2.2 Successful CS SMS mobile terminating

- a) This measurement provides the number of successful CS SMS mobile terminating attempts.  
The three measurement types defined in e) are subject to the "2 out of 3 approach".
- b) CC.
- c) Receipt by the MSC of "RP-ACK" Message (TS 24.011).
- d) A single integer value per measurement type defined in e).
- e) SMS.SuccMtCS:
  - SMS.SuccMtCS Combined (don't care);
  - SMS.SuccMtCS.G GSM;
  - SMS.SuccMtCS.U UMTS.
- f) MscFunction.
- g) Valid for circuit switching.
- h) GSM/UMTS.

## 5.5.1.3 CS ms-Present

### 5.5.1.3.1 Attempted CS ms-Present

- a) This attribute counts the number of times that a MS (attached to a MSC) send that it is ready to receive SM.  
The three measurement types defined in e) are subject to the "2 out of 3 approach".
- b) CC.
- c) Transmission of MAP-READY-FOR-SM with alertReason = ms-Present to the HLR from the MSC (TS 29.002).
- d) A single integer value per measurement type defined in e).
- e) SMS.AttMsPresentCS:

- SMS.AttMsPresentCS Combined (don't care);
  - SMS.AttMsPresentCS.G GSM;
  - SMS.AttMsPresentCS.U UMTS.
- f) MscFunction.
- g) Valid for circuit switching.
- h) GSM/UMTS.

#### 5.5.1.3.2 Successful CS ms-Present

- a) This attribute counts the number of successful times that a MS (attached to a MSC) send that it is ready to receive SM.  
The three measurement types defined in e) are subject to the "2 out of 3 approach".
- b) CC.
- c) This counter will be increased when a return result is received by the MSC from the HLR in response to the MAP\_READY\_FOR\_SM with reason = "MS present" (TS 29.002).
- d) A single integer value per measurement type defined in e).
- e) SMS.SuccMsPresentCS:
- SMS.SuccMsPresentCS Combined (don't care);
  - SMS.SuccMsPresentCS.G GSM;
  - SMS.SuccMsPresentCS.U UMTS.
- f) MscFunction.
- g) Valid for circuit switching.
- h) GSM/UMTS.

#### 5.5.1.4 CS "memory available"

##### 5.5.1.4.1 Attempted CS "memory available"

- a) This attribute counts the number of times that a MS (attached to a MSC) sent a indication of "memory available" to MSC.  
The three measurement types defined in e) are subject to the "2 out of 3 approach".
- b) CC.
- c) Transmission of MAP-READY-FOR-SM with alertReason = memoryAvailable to the HLR from the MSC (TS 29.002).
- d) A single integer value per measurement type defined in e).
- e) SMS.AttMemoryAvailableCS:
- SMS.AttMemoryAvailableCS Combined (don't care);
  - SMS.AttMemoryAvailableCS.G GSM;
  - SMS.AttMemoryAvailableCS.U UMTS.
- f) MscFunction.
- g) Valid for circuit switching.

h) GSM/UMTS.

#### 5.5.1.4.2 Successful CS "memory available"

- a) This attribute counts the number of successful times that a MS (attached to a MSC) sent an indication of "memory available" to MSC.  
The three measurement types defined in e) are subject to the "2 out of 3 approach".
- b) CC.
- c) This counter will be increased when a return result is received by the MSC from the HLR in response to the MAP\_READY\_FOR\_SM with reason = "memory available" (TS 29.002).
- d) A single integer value per measurement type defined in e).
- e) SMS.SuccMemoryAvailableCS:
- SMS.SuccMemoryAvailableCS Combined (don't care);
  - SMS.SuccMemoryAvailableCS.G GSM;
  - SMS.SuccMemoryAvailableCS.U UMTS.
- f) MscFunction.
- g) Valid for circuit switching.
- h) GSM/UMTS.

### 5.5.2 SMS in the PS domain (SGSN)

Up to now, no counters are defined for the failure cases FFS.

#### 5.5.2.1 PS SMS mobile originating

##### 5.5.2.1.1 Attempted PS SMS mobile originating

- a) This measurement provides the number of PS SMS mobile originating attempts.  
The three measurement types defined in e) are subject to the "2 out of 3 approach".
- b) CC.
- c) Receipt by the SGSN of "RP-DATA" Message (TS 24.011) from the MS.
- d) A single integer value per measurement type defined in e).
- e) SMS.AttMoPS:
- SMS.AttMoPS Combined (don't care);
  - SMS.AttMoPS.G GSM;
  - SMS.AttMoPS.U UMTS.
- f) SgsnFunction.
- g) Valid for packet switching.
- h) GSM/UMTS.

##### 5.5.2.1.2 Successful PS SMS mobile originating

- a) This measurement provides the number of successful PS SMS mobile originating attempts.  
The three measurement types defined in e) are subject to the "2 out of 3 approach".



- b) CC.
- c) Transmission by the SGSN of "RP-ACK" Message (TS 24.011) to the MS.
- d) A single integer value per measurement type defined in e).
- e) SMS.SuccMoPS:
  - SMS.SuccMoPS Combined (don't care);
  - SMS.SuccMoPS.G GSM;
  - SMS.SuccMoPS.U UMTS.
- f) SgsnFunction.
- g) Valid for packet switching.
- h) GSM/UMTS.

## 5.5.2.2 PS SMS mobile terminating

### 5.5.2.2.1 Attempted PS SMS mobile terminating

- a) This measurement provides the number of PS SMS mobile terminating attempts. The three measurement types defined in e) are subject to the "2 out of 3 approach".
- b) CC.
- c) Transmission by the SGSN of "RP-DATA" Message (TS 24.011).
- d) A single integer value per measurement type defined in e).
- e) SMS.AttMtPS:
  - SMS.AttMtPS Combined (don't care);
  - SMS.AttMtPS.G GSM;
  - SMS.AttMtPS.U UMTS.
- f) SgsnFunction.
- g) Valid for packet switching.
- h) GSM/UMTS.

### 5.5.2.2.2 Successful PS SMS mobile terminating

- a) This measurement provides the number of successful PS SMS mobile terminating attempts. The three measurement types defined in e) are subject to the "2 out of 3 approach".
- b) CC.
- c) Receipt by the SGSN of "RP-ACK" Message (TS 24.011).
- d) A single integer value per measurement type defined in e).
- e) SMS.SuccMtPS:
  - SMS.SuccMtPS Combined (don't care);
  - SMS.SuccMtPS.G GSM;
  - SMS.SuccMtPS.U UMTS.
- f) SgsnFunction.

- g) Valid for packet switching.
- h) GSM/UMTS.

### 5.5.2.3 PS ms-Present

#### 5.5.2.3.1 Attempted PS ms-Present

- a) This attribute counts the number of times that a MS (attached to a SGSN) send that it is ready to receive SM. The three measurement types defined in e) are subject to the "2 out of 3 approach".
- b) CC.
- c) Transmission of MAP-READY-FOR-SM with alertReason = ms-Present to the HLR from the SGSN (TS 29.002).
- d) A single integer value per measurement type defined in e).
- e) SMS.AttMsPresentPS:
  - SMS.AttMsPresentPS Combined (don't care);
  - SMS.AttMsPresentPS.G GSM;
  - SMS.AttMsPresentPS.U UMTS.
- f) SgsnFunction.
- g) Valid for packet switching.
- h) GSM/UMTS.

#### 5.5.2.3.2 Successful PS ms-Present

- a) This attribute counts the number of successful times that a MS (attached to a SGSN) send that it is ready to receive SM. The three measurement types defined in e) are subject to the "2 out of 3 approach".
- b) CC.
- c) This counter will be increased when a return result is received by the SGSN from the HLR in response to the MAP\_READY\_FOR\_SM with reason = "MS present" (TS 29.002).
- d) A single integer value per measurement type defined in e).
- e) SMS.SuccMsPresentPS:
  - SMS.SuccMsPresentPS Combined (don't care);
  - SMS.SuccMsPresentPS.G GSM;
  - SMS.SuccMsPresentPS.U UMTS.
- f) SgsnFunction.
- g) Valid for packet switching.
- h) GSM/UMTS.

#### 5.5.2.4 PS "memory available"

##### 5.5.2.4.1 Attempted PS "memory available"

- a) This attribute counts the number of times that a MS (attached to a SGSN) sent a indication of "memory available" to SGSN.  
The three measurement types defined in e) are subject to the "2 out of 3 approach".
- b) CC.
- c) Transmission of MAP-READY-FOR-SM with alertReason = memoryAvailable to the HLR from the SGSN (TS 29.002).
- d) A single integer value per measurement type defined in e).
- e) SMS.AttMemoryAvailablePS:
  - SMS.AttMemoryAvailablePS Combined (don't care);
  - SMS.AttMemoryAvailablePS.G GSM;
  - SMS.AttMemoryAvailablePS.U UMTS.
- f) SgsnFunction.
- g) Valid for packet switching.
- h) GSM/UMTS.

##### 5.5.2.4.2 Successful PS "memory available"

- a) This attribute counts the number of successful times that a MS (attached to a SGSN) sent a indication of "memory available" to SGSN.  
The three measurement types defined in e) are subject to the "2 out of 3 approach".
- b) CC.
- c) This counter will be increased when a return result is received by the SGSN from the HLR in response to the MAP\_READY\_FOR\_SM with reason = "memory available" (TS 29.002).
- d) A single integer value per measurement type defined in e).
- e) SMS.SuccMemoryAvailablePS:
  - SMS.SuccMemoryAvailablePS Combined (don't care);
  - SMS.SuccMemoryAvailablePS.G GSM;
  - SMS.SuccMemoryAvailablePS.U UMTS.
- f) SgsnFunction.
- g) Valid for packet switching.
- h) GSM/UMTS.

### 5.5.3 SMS in the CS/PS domain (MSC/SGSN)

Unlike the measurements in previous clauses, the measurements in this subclause do not differentiate between the PS and the CS domain, and deliver one total count.

Up to now, no counters are defined for the failure cases FFS.

### 5.5.3.1 SMS mobile originating

#### 5.5.3.1.1 Attempted SMS mobile originating

- a) This measurement provides the number of SMS mobile originating attempts.  
The three measurement types defined in e) are subject to the "2 out of 3 approach".
- b) CC.
- c) Receipt by the MSC/SGSN of "RP-DATA" Message (TS 24.011) from the MS.
- d) A single integer value per measurement type defined in e).
- e) SMS.AttMo:
  - SMS.AttMo Combined (don't care);
  - SMS.AttMo.G GSM;
  - SMS.AttMo.U UMTS.
- f) MscFunction or SgsnFunction.
- g) Valid for packet switching and circuit switching.
- h) GSM/UMTS.

#### 5.5.3.1.2 Successful SMS mobile originating

- a) This measurement provides the number of successful SMS mobile originating attempts.  
The three measurement types defined in e) are subject to the "2 out of 3 approach".
- b) CC.
- c) Transmission by the MSC/SGSN of "RP-ACK" Message (TS 24.011) to the MS.
- d) A single integer value per measurement type defined in e).
- e) SMS.SuccMo:
  - SMS.SuccMo Combined (don't care);
  - SMS.SuccMo.G GSM;
  - SMS.SuccMo.U UMTS.
- f) MscFunction or SgsnFunction.
- g) Valid for packet switching and circuit switching.
- h) GSM/UMTS.

### 5.5.3.2 SMS mobile terminating

#### 5.5.3.2.1 Attempted SMS mobile terminating

- a) This measurement provides the number of SMS mobile terminating attempts.  
The three measurement types defined in e) are subject to the "2 out of 3 approach".
- b) CC.
- c) Transmission by the MSC/SGSN of "RP-DATA" Message (TS 24.011).
- d) A single integer value per measurement type defined in e).
- e) SMS.AttMt:

- SMS.AttMt Combined (don't care);
  - SMS.AttMt.G GSM;
  - SMS.AttMt.U UMTS.
- f) MscFunction or SgsnFunction.
- g) Valid for packet switching and circuit switching.
- h) GSM/UMTS.

#### 5.5.3.2.2 Successful SMS mobile terminating

- a) This measurement provides the number of successful SMS mobile terminating attempts. The three measurement types defined in e) are subject to the "2 out of 3 approach".
- b) CC.
- c) Receipt by the MSC/SGSN of "RP-ACK" Message (TS 24.011).
- d) A single integer value per measurement type defined in e).
- e) SMS.SuccMt:
- SMS.SuccMt Combined (don't care);
  - SMS.SuccMt.G GSM;
  - SMS.SuccMt.U UMTS.
- f) MscFunction or SgsnFunction.
- g) Valid for packet switching and circuit switching.
- h) GSM/UMTS.

#### 5.5.3.3 Ms-Present

##### 5.5.3.3.1 Attempted ms-Present

- a) This attribute counts the number of times that a MS (attached to a MSC/SGSN) send that it is ready to receive SM. The three measurement types defined in e) are subject to the "2 out of 3 approach".
- b) CC.
- c) Transmission of MAP-READY-FOR-SM with alertReason = ms-Present to the HLR from the MSC/SGSN (TS 29.002).
- d) A single integer value per measurement type defined in e).
- e) SMS.AttMsPresent:
- SMS.AttMsPresent Combined (don't care);
  - SMS.AttMsPresent.G GSM;
  - SMS.AttMsPresent.U UMTS.
- f) MscFunction or SgsnFunction.
- g) Valid for packet switching and circuit switching.
- h) GSM/UMTS.

### 5.5.3.3.2 Successful ms-Present

- a) This attribute counts the number of successful times that a MS (attached to a MSC/SGSN) send that it is ready to receive SM.  
The three measurement types defined in e) are subject to the "2 out of 3 approach".
- b) CC.
- c) This counter will be increased when a return result is received by the MSC/SGSN from the HLR in response to the MAP\_READY\_FOR\_SM with reason = "MS present" (TS 29.002).
- d) A single integer value per measurement type defined in e).
- e) SMS.SuccMsPresent:
  - SMS.SuccMsPresent Combined (don't care);
  - SMS.SuccMsPresent.G GSM;
  - SMS.SuccMsPresent.U UMTS.
- f) MscFunction or SgsnFunction.
- g) Valid for packet switching and circuit switching.
- h) GSM/UMTS.

### 5.5.3.4 "Memory available"

#### 5.5.3.4.1 Attempted "memory available"

- a) This attribute counts the number of times that a MS (attached to a MSC/SGSN) sent a indication of "memory available" to MSC/SGSN.  
The three measurement types defined in e) are subject to the "2 out of 3 approach".
- b) CC.
- c) Transmission of MAP-READY-FOR-SM with alertReason = memoryAvailable to the HLR from the MSC/SGSN (TS 29.002).
- d) A single integer value per measurement type defined in e).
- e) SMS.AttMemoryAvailable:
  - SMS.AttMemoryAvailable Combined (don't care);
  - SMS.AttMemoryAvailable.G GSM;
  - SMS.AttMemoryAvailable.U UMTS.
- f) MscFunction or SgsnFunction.
- g) Valid for packet switching and circuit switching.
- h) GSM/UMTS.

#### 5.5.3.4.2 Successful "memory available"

- a) This attribute counts the number of successful times that a MS (attached to a MSC/SGSN) sent a indication of "memory available" to MSC/SGSN.  
The three measurement types defined in e) are subject to the "2 out of 3 approach".
- b) CC.
- c) This counter will be increased when a return result is received by the MSC/SGSN from the HLR in response to the MAP\_READY\_FOR\_SM with reason = "memory available" (TS 29.002).

- d) A single integer value per measurement type defined in e).
- e) SMS.SuccMemoryAvailable:
  - SMS.SuccMemoryAvailable Combined (don't care);
  - SMS.SuccMemoryAvailable.G GSM;
  - SMS.SuccMemoryAvailable.U UMTS.
- f) MscFunction or SgsnFunction.
- g) Valid for packet switching and circuit switching.
- h) GSM/UMTS.

## 5.6 Session Management

### 5.6.1 PDP context activation procedures initiated by MS

#### 5.6.1.1 Attempted PDP context activation procedures initiated by MS

- a) This measurement provides the number of attempted PDP context activation procedures. These include the static as well as the dynamic PDP addresses.  
The three measurement types defined in e) are subject to the "2 out of 3 approach".
- b) CC.
- c) Receipt of a "Activate PDP Context Request" message from the MS (TS 24.008).
- d) A single integer value.
- e) SM.AttActPdpContext:
  - SM.AttActPdpContext Combined (don't care);
  - SM.AttActPdpContext.G GSM;
  - SM.AttActPdpContext.U UMTS.
- f) SgsnFunction.
- g) Valid for packet switching.
- h) GSM/UMTS.

#### 5.6.1.2 Successful PDP context activation procedures initiated by MS

- a) This measurement provides the number of successfully completed PDP context activations. For these context activations, the GGSN is updated successfully.  
The three measurement types defined in e) are subject to the "2 out of 3 approach".
- b) CC.
- c) Transmission of a "Activate PDP Context Accept" message to the MS (TS 24.008).
- d) A single integer value per measurement type defined in e).
- e) SM.SuccActPdpContext:
  - SM.SuccActPdpContext Combined (don't care);
  - SM.SuccActPdpContext.G GSM;

- SM.SuccActPdpContext.U            UMTS.
- f) SgsnFunction.
- g) Valid for packet switching.
- h) GSM/UMTS.

### 5.6.1.3 Failed PDP context activation procedures initiated by MS

- a) This measurement provides the number of Failed PDP context activation procedures. These include the static as well as the dynamic PDP addresses. This measurement is split into subcounters per failure cause. The three measurement types defined in e) are subject to the "2 out of 3 approach".
- b) CC.
- c) Transmission by the SGSN of an ACTIVATE PDP CONTEXT REJECT message indicating a PDP context activation failure, the relevant measurement is incremented according to the failure cause. Possible causes are included in TS 24.008 Annex G. The sum of all supported per cause measurements should equal the total number of PDP context activation failures. In case only a subset of per cause measurements is supported, a sum subcounter will be provided first.
- d) A single integer value per measurement type as defined in e). The number of measurements is equal to the number of implemented per cause measurements plus a possible sum value identified by the *.sum* suffix.
- e) The measurement name has the form SM.FailActPdpCtxtMs.Cause where Cause identifies the failure cause.
  - SM.FailActPdpCtxtMs.Cause            Combined (don't care);
  - SM.FailActPdpCtxtMs.Cause.G        GSM;
  - SM.FailActPdpCtxtMs.Cause.U        UMTS;
 where *Cause* identifies the failure cause.
- f) SgsnFunction.
- g) Valid for packet switching.
- h) GSM/UMTS.

## 5.6.2 dynamic PDP context activation procedures initiated by MS

### 5.6.2.1 Attempted dynamic PDP context activation procedures initiated by MS

- a) This measurement provides the number of attempted PDP context activation requests where a dynamic PDP address is required to be used.  
The three measurement types defined in e) are subject to the "2 out of 3 approach".
- b) CC.
- c) Receipt of a "Activate PDP Context Request" message from the MS with an empty PDP address (TS 24.008).
- d) A single integer value per measurement type defined in e).
- e) SM.AttActPdpContextDyn:
  - SM.AttActPdpContextDyn            Combined (don't care);
  - SM.AttActPdpContextDyn.G        GSM;
  - SM.AttActPdpContextDyn.U        UMTS.
- f) SgsnFunction.



- g) Valid for packet switching.
- h) GSM/UMTS.

### 5.6.2.2 Successful dynamic PDP context activation procedures initiated by MS

- a) This measurement provides the number of successfully completed PDP context activations where a dynamic PDP address is used.  
The three measurement types defined in e) are subject to the "2 out of 3 approach".
- b) CC.
- c) Transmission of a "Activate PDP Context Accept" message to the MS (TS 24.008), the PDP address has been dynamically assigned.
- d) A single integer value per measurement type defined in e).
- e) SM.SuccActPdpContextDyn:
  - SM.SuccActPdpContextDyn Combined (don't care);
  - SM.SuccActPdpContextDyn.G GSM;
  - SM.SuccActPdpContextDyn.U UMTS.
- f) SgsnFunction.
- g) Valid for packet switching.
- h) GSM/UMTS.

### 5.6.3 Mean number of activated PDP contexts

- a) Mean number of activated PDP contexts.  
The three measurement types defined in e) are subject to the "2 out of 3 approach".
- b) SI.
- c) This measurement is obtained by sampling at a pre-defined interval, the number activated PDP contexts, and then taking the arithmetic mean.
- d) A single integer value per measurement type defined in e).
- e) SM.MeanActPDPContext:
  - SM.MeanActPDPContext Combined (don't care);
  - SM.MeanActPDPContext.G GSM;
  - SM.MeanActPDPContext.U UMTS.
- f) SgsnFunction.
- g) Valid for packet switching.
- h) GSM/UMTS.

### 5.6.4 PDP context deactivation procedures initiated by the MS

#### 5.6.4.1 Attempted PDP context deactivation procedures initiated by the MS

- a) This measurement provides the number of PDP context deactivation procedures initiated by the MS.  
The three measurement types defined in e) are subject to the "2 out of 3 approach".
- b) CC.

- c) Receipt of a "Deactivate PDP Context Request" message from the MS (TS 24.008).
- d) A single integer value per measurement type defined in e).
- e) SM.AttDeactPdpContextMs:
  - SM.AttDeactPdpContextMs Combined (don't care);
  - SM.AttDeactPdpContextMs.G GSM;
  - SM.AttDeactPdpContextMs.U UMTS.
- f) SgsnFunction.
- g) Valid for packet switching.
- h) GSM/UMTS.

#### 5.6.4.2 Successful PDP context deactivation procedures initiated by the MS

- a) This measurement provides the number of successfully completed PDP context deactivations. For these context deactivations, the GGSN is updated successfully (i.e. deletion of the PDP context). The three measurement types defined in e) are subject to the "2 out of 3 approach".
- b) CC.
- c) Transmission of a "Deactivate PDP Context Accept" message to the MS (TS 24.008).
- d) A single integer value per measurement type defined in e).
- e) SM.SuccDeactPdpContextMs:
  - SM.SuccDeactPdpContextMs Combined (don't care);
  - SM.SuccDeactPdpContextMs.G GSM;
  - SM.SuccDeactPdpContextMs.U UMTS.
- f) SgsnFunction.
- g) Valid for packet switching.
- h) GSM/UMTS.

#### 5.6.5 Number of active PDP context

- a) This measurement provides the number of active PDP context. The three measurement types defined in e) are subject to the "2 out of 3 approach".
- b) GAUGE.
- c) The gauge will be incremented when a PDP context is created and will be decremented when a PDP context is deleted.
- d) A single integer value per measurement type defined in e).
- e) SM.NbrActPdpContext:
  - SM.NbrActPdpContext Combined (don't care);
  - SM.NbrActPdpContext.G GSM;
  - SM.NbrActPdpContext.U UMTS.
- f) SgsnFunction.
- g) Valid for packet switching.

- h) GSM/UMTS.

## 5.6.6 Subscribers with activated PDP context

### 5.6.6.1 Number of subscribers with activated PDP context

- a) This measurement provides the number of subscribers having an activated PDP context (i.e. subscribers that can send/receive GPRS packet data).  
The three measurement types defined in e) are subject to the "2 out of 3 approach".
- b) GAUGE.
- c) Addition of first PDP context or removal of last PDP context in SGSN location register for a particular subscriber.
- d) A single integer value per measurement type defined in e).
- e) SM.NbrActivePdpPerSgsn:
  - SM.NbrActivePdpPerSgsn Combined (don't care);
  - SM.NbrActivePdpPerSgsn.G GSM;
  - SM.NbrActivePdpPerSgsn.U UMTS.
- f) SgsnFunction.
- g) Valid for packet switching.
- h) GSM/UMTS.

### 5.6.6.2 Mean number of subscribers with activated PDP context

- a) This measurement provides the mean number of subscribers having an activated PDP context (i.e. subscribers that can send/receive GPRS packet data).  
The three measurement types defined in e) are subject to the "2 out of 3 approach".
- b) SI.
- c) This measurement is obtained by sampling at a pre-defined interval the number of subscribers having an activated PDP context in SGSN and then taking the arithmetic mean.
- d) A single integer value per measurement type defined in e).
- e) SM.MeanActivePdpPerSgsn:
  - SM.MeanActivePdpPerSgsn Combined (don't care);
  - SM.MeanActivePdpPerSgsn.G GSM;
  - SM.MeanActivePdpPerSgsn.U UMTS.
- f) SgsnFunction.
- g) Valid for packet switching.
- h) GSM/UMTS.

### 5.6.6.3 Max number of subscribers with activated PDP context

- a) This measurement provides the maximum number of subscribers having an activated PDP context (i.e. subscribers that can send/receive GPRS packet data).  
The three measurement types defined in e) are subject to the "2 out of 3 approach".
- b) SI.

- c) This measurement is obtained by sampling at a pre-defined interval the number of subscribers having an activated PDP context in SGSN and then taking the maximum.
- d) A single integer value per measurement type defined in e).
- e) SM.MaxActivePdpPerSgsn:
  - SM.MaxActivePdpPerSgsn Combined (don't care);
  - SM.MaxActivePdpPerSgsn.G GSM;
  - SM.MaxActivePdpPerSgsn.U UMTS.
- f) SgsnFunction.
- g) Valid for packet switching.
- h) GSM/UMTS.

## 5.6.7 Void

## 5.6.8 PDP context deactivation procedures initiated by the GGSN

### 5.6.8.1 Attempted PDP context deactivation procedures initiated by the GGSN

- a) This measurement provides the number of PDP context deactivation procedures initiated by the GGSN. The three measurement types defined in e) are subject to the "2 out of 3 approach".
- b) CC.
- c) Receipt of a "Delete PDP Context Request" message from the GGSN (TS 29.060).
- d) A single integer value per measurement type defined in e).
- e) SM.AttDeactPdpContextGgsn:
  - SM.AttDeactPdpContextGgsn Combined (don't care);
  - SM.AttDeactPdpContextGgsn.G GSM;
  - SM.AttDeactPdpContextGgsn.U UMTS.
- f) SgsnFunction.
- g) Valid for packet switching.
- h) GSM/UMTS.

### 5.6.8.2 Successful PDP context deactivation procedures initiated by the GGSN

- a) This measurement provides the number of successfully handled PDP context deactivations initiated by the GGSN. For these context deactivations, the MS has accepted the PDP context deactivation. The three measurement types defined in e) are subject to the "2 out of 3 approach".
- b) CC.
- c) Transmission of a "Delete PDP Context Response" message to the GGSN (TS 29.060).
- d) A single integer value per measurement type defined in e).
- e) SM.SuccDeactPdpContextGgsn:
  - SM.SsuccDeactPdpContextGgsn Combined (don't care);
  - SM.SsuccDeactPdpContextGgsn.G GSM;

- SM.SsuccDeactPdpContextGgsn.U UMTS.
- f) SgsnFunction.
- g) Valid for packet switching.
- h) GSM/UMTS.

## 5.6.9 PDP context deactivation procedures initiated by the SGSN

### 5.6.9.1 Attempted PDP context deactivation procedures initiated by the SGSN

- a) This measurement provides the number of PDP context deactivation procedures initiated by the SGSN. The three measurement types defined in e) are subject to the "2 out of 3 approach".
- b) CC.
- c) Transmission of a "Delete PDP Context Request" message to the GGSN (TS 29.060).
- d) A single integer value per measurement type defined in e).
- e) SM.AttDeactPdpContextSgsn:
  - SM.AttDeactPdpContextSgsn Combined (don't care);
  - SM.AttDeactPdpContextSgsn.G GSM;
  - SM.AttDeactPdpContextSgsn.U UMTS.
- f) SgsnFunction.
- g) Valid for packet switching.
- h) GSM/UMTS.

### 5.6.9.2 Successful PDP context deactivations initiated by the SGSN

- a) This measurement provides the number of successfully handled PDP context deactivations initiated by the SGSN. The three measurement types defined in e) are subject to the "2 out of 3 approach".
- b) CC.
- c) Receipt of a "deactivate PDP Context Accept" message from the MS (TS 24.008).
- d) A single integer value per measurement type defined in e).
- e) SM.SuccDeactPdpContextSgsn:
  - SM.SuccDeactPdpContextSgsn Combined (don't care);
  - SM.SuccDeactPdpContextSgsn.G GSM;
  - SM.SuccDeactPdpContextSgsn.U UMTS.
- f) SgsnFunction.
- g) Valid for packet switching.
- h) GSM/UMTS.

### 5.6.9.3 Abnormal PDP context Deactivation procedures

- a) This measurement provides the number of PDP context deactivation procedures initiated by the SGSN. This measurement is split into subcounters per cause.

- b) CC.
- c) Transmission of a "Delete PDP Context Request" message to the GGSN (TS 29.060). the measurement is incremented according to the deletion cause. Possible causes are included in TS 24.008. The sum of all supported per cause measurements should equal the total number of PDP context activation failures.
- d) A single integer value.
- e) SM.AttDeactPdpContextSgsn.cause
- f) SgsnFunction.
- g) Valid for packet switching.
- h) GSM/UMTS.

## 5.6.10 SGSN-Initiated PDP context update procedures

### 5.6.10.1 Attempted SGSN-Initiated PDP context update procedures

- a) This measurement provides the number of attempted SGSN-Initiated PDP context update procedures. An Update PDP Context Request message shall be sent from a SGSN to a GGSN as part of the GPRS Inter SGSN Routing Update procedure or the PDP Context Modification procedure or to redistribute contexts due to load sharing. It shall be used to change the QoS and the path. The message shall be sent by the new SGSN at the Inter SGSN Routing Update procedure.  
The three measurement types defined in e) are subject to the "2 out of 3 approach".
- b) CC.
- c) Transmission of an "Update PDP Context Request" message to the GGSN (TS 29.060).
- d) A single integer value per measurement type defined in e).
- e) SM.AttUpdPdpContextSgsn:
  - SM.AttUpdPdpContextSgsn Combined (don't care);
  - SM.AttUpdPdpContextSgsn.G GSM;
  - SM.AttUpdPdpContextSgsn.U UMTS.
- f) SgsnFunction.
- g) Valid for packet switching.
- h) GSM/UMTS.

### 5.6.10.2 Successful SGSN-Initiated PDP context update procedures

- a) This measurement provides the number of successfully handled SGSN-Initiated PDP context update procedures. These updates are performed successfully when a positive update PDP context response is received from the GGSN.  
The three measurement types defined in e) are subject to the "2 out of 3 approach".
- b) CC.
- c) Receipt of an "Update PDP Context Response" message from the GGSN (TS 29.060).
- d) A single integer value per measurement type defined in e).
- e) SM.SsuccUpdPdpContextSgsn:
  - SM.SsuccUpdPdpContextSgsn Combined (don't care);
  - SM.SsuccUpdPdpContextSgsn.G GSM;

- SM.SsuccUpdPdpContextSgsn.U UMTS.
- f) SgsnFunction.
- g) Valid for packet switching.
- h) GSM/UMTS.

## 5.6.11 GGSN-Initiated PDP context update procedures

### 5.6.11.1 Attempted GGSN-Initiated PDP context update procedures

- a) This measurement provides the number of attempted GGSN-Initiated PDP context update procedures. An Update PDP Context Request may also be sent from a GGSN to a SGSN to re-negotiate the QoS of a PDP context. This GGSN-initiated Update PDP Context Request can also be used to provide a PDP address to the SGSN (and MS). The latter shall be used by GGSN when it acts as a DHCP Relay Agent or Mobil IP Foreign Agent.  
The three measurement types defined in e) are subject to the "2 out of 3 approach".
- b) CC.
- c) Receipt of an "Update PDP Context Request" message from the GGSN (TS 29.060).
- d) A single integer value per measurement type defined in e).
- e) SM.AttUpdPdpContextGgsn:
  - SM.AttUpdPdpContextGgsn Combined (don't care);
  - SM.AttUpdPdpContextGgsn.G GSM;
  - SM.AttUpdPdpContextGgsn.U UMTS.
- f) SgsnFunction.
- g) Valid for packet switching.
- h) GSM/UMTS.

### 5.6.11.2 Successful GGSN-Initiated PDP context update procedures

- a) This measurement provides the number of successfully handled GGSN-Initiated PDP context update procedures. These updates are performed successfully when a positive update PDP context response is received from the SGSN.  
The three measurement types defined in e) are subject to the "2 out of 3 approach".
- b) CC.
- c) Transmission of an "Update PDP Context Response" message to the GGSN (TS 29.060).
- d) A single integer value per measurement type defined in e).
- e) SM.SuccUpdPdpContextGgsn:
  - SM.SuccUpdPdpContextGgsn Combined (don't care);
  - SM.SuccUpdPdpContextGgsn.G GSM;
  - SM.SuccUpdPdpContextGgsn.U UMTS.
- f) SgsnFunction.
- g) Valid for packet switching.
- h) GSM/UMTS.

## 5.6.12 SGSN-Initiated PDP context modifications procedures

### 5.6.12.1 Attempted SGSN-Initiated PDP context modifications procedures

- a) This measurement provides the number of attempted SGSN-Initiated PDP context modifications procedures. The three measurement types defined in e) are subject to the "2 out of 3 approach".
- b) CC.
- c) Transmission of an "Modify PDP Context Request" message to the MS (TS 24.008).
- d) A single integer value per measurement type defined in e).
- e) SM.AttModPdpContextSgsn:
  - SM.AttModPdpContextSgsn Combined (don't care);
  - SM.AttModPdpContextSgsn.G GSM;
  - SM.AttModPdpContextSgsn.U UMTS.
- f) SgsnFunction.
- g) Valid for packet switching.
- h) GSM/UMTS.

### 5.6.12.2 Successfully SGSN-Initiated PDP context modifications procedures

- a) This measurement provides the number of successfully handled SGSN-Initiated PDP context modifications procedures. These modifications are performed successfully when a positive Modify PDP Context Accept is received from the MS. The three measurement types defined in e) are subject to the "2 out of 3 approach".
- b) CC.
- c) Receipt of an "Modify PDP Context Accept" message from the MS (TS 24.008).
- d) A single integer value per measurement type defined in e).
- e) SM.SuccModPdpContextSgsn:
  - SM.SuccModPdpContextSgsn Combined (don't care);
  - SM.SuccModPdpContextSgsn.G GSM;
  - SM.SuccModPdpContextSgsn.U UMTS.
- f) SgsnFunction.
- g) Valid for packet switching.
- h) GSM/UMTS.

## 5.6.13 MS-Initiated PDP context modifications procedures

### 5.6.13.1 Attempted MS-Initiated PDP context modifications procedures

- a) This measurement provides the number of attempted MS-Initiated PDP context modifications procedures. The three measurement types defined in e) are subject to the "2 out of 3 approach".
- b) CC.
- c) Receipt of an "Modify PDP Context Request" message from the MS (TS 24.008).



- d) A single integer value per measurement type defined in e).
- e) SM.AttModPdpContextMs:
  - SM.AttModPdpContextMs Combined (don't care);
  - SM.AttModPdpContextMs.G GSM;
  - SM.AttModPdpContextMs.U UMTS.
- f) SgsnFunction.
- g) Valid for packet switching.
- h) GSM/UMTS.

### 5.6.13.2 Successfully MS-Initiated PDP context modifications procedures

- a) This measurement provides the number of successfully handled MS-Initiated PDP context modifications procedures. These modifications are performed successfully when a positive Modify PDP Context Accept is received from the MS.  
The three measurement types defined in e) are subject to the "2 out of 3 approach".
- b) CC.
- c) Transmission of an "Modify PDP Context Accept" message to the MS (TS 24.008).
- d) A single integer value per measurement type defined in e).
- e) SM.SsuccModPdpContextMs:
  - SM.SsuccModPdpContextMs Combined (don't care);
  - SM.SsuccModPdpContextMs.G GSM;
  - SM.SsuccModPdpContextMs.U UMTS.
- f) SgsnFunction.
- g) Valid for packet switching.
- h) GSM/UMTS.

### 5.6.14 Secondary PDP context activation procedures

#### 5.6.14.1 Attempted Secondary PDP context activation procedures

- a) This measurement provides the number of attempted Secondary PDP context activation procedures.  
The three measurement types defined in e) are subject to the "2 out of 3 approach".
- b) CC.
- c) Receipt of a "Activate Secondary PDP Context Request" message from the MS (TS 24.008).
- d) A single integer value per measurement type defined in e).
- e) SM.AttActSecondPdpContext:
  - SM.AttActSecondPdpContext Combined (don't care);
  - SM.AttActSecondPdpContext.G GSM;
  - SM.AttActSecondPdpContext.U UMTS.
- f) SgsnFunction.

- g) Valid for packet switching.
- h) GSM/UMTS.

#### 5.6.14.2 Successful Secondary PDP context activations

- a) This measurement provides the number of successfully completed Secondary PDP context activations. The three measurement types defined in e) are subject to the "2 out of 3 approach".
- b) CC.
- c) Transmission of a "Activate Secondary PDP Context Accept" message to the MS (TS 24.008).
- d) A single integer value per measurement type defined in e).
- e) SM.SuccActSecondPdpContext:
  - SM.SuccActSecondPdpContext Combined (don't care);
  - SM.SuccActSecondPdpContext.G GSM;
  - SM.SuccActSecondPdpContext.U UMTS.
- f) SgsnFunction.
- g) Valid for packet switching.
- h) GSM/UMTS.

#### 5.6.15 PDP context activation procedures initiated by Network

##### 5.6.15.1 Attempted PDP context activation procedures initiated by Network

- a) This measurement provides the number of attempted PDP context activation procedures initiated by Network. These include the static as well as the dynamic PDP addresses. The three measurement types defined in e) are subject to the "2 out of 3 approach".
- b) CC.
- c) Receipt of a "PDU Notification Request" message from the MS (TS29.060) message from GGSN.
- d) A single integer value.
- e) SM.AttActPdpCtxtNtwk:
  - SM.AttActPdpCtxtNtwk Combined (don't care);
  - SM.AttActPdpCtxtNtwk.G GSM;
  - SM.AttActPdpCtxtNtwk.U UMTS.
- f) SgsnFunction.
- g) Valid for packet switching.
- h) GSM/UMTS.

##### 5.6.15.2 Successful PDP context activation procedures initiated by Network

- a) This measurement provides the number of successful PDP context activation procedures. These include the static as well as the dynamic PDP addresses. The three measurement types defined in e) are subject to the "2 out of 3 approach".
- b) CC.

- c) Transmission by the SGSN of a "Activate PDP Context Accept" message (TS 24.008) to MS for the PDP context activation initiated by Network.
- d) A single integer value.
- e) SM.SuccActPdpCtxtNtwk:
  - SM.SuccActPdpCtxtNtwk Combined (don't care);
  - SM.SuccActPdpCtxtNtwk.G GSM;
  - SM.SuccActPdpCtxtNtwk.U UMTS.
- f) SgsnFunction.
- g) Valid for packet switching.
- h) GSM/UMTS.

### 5.6.15.3 Failed PDP context activation procedures initiated by Network

- a) This measurement provides the number of Failed PDP context activation procedures. These include the static as well as the dynamic PDP addresses. This measurement is split into subcounters per failure cause.
- b) CC.
- c) Receipt of a "REQUEST PDP CONTEXT ACTIVATION REJECT" message from the MS (TS 24.008) message indicating a PDP context activation failure, the measurement is incremented according to the failure cause. Possible causes are included in TS 24.008. The sum of all supported per cause measurements should equal the total number of PDP context activation failures.
- d) A single integer value.
- e) The measurement name has the form SM.FailActPdpCtxtNtwk.Cause where Cause identifies the failure cause.
- f) SgsnFunction.
- g) Valid for packet switching.
- h) GSM/UMTS.

### 5.6.16 PDP Context set-up time, initiated by MS (Mean)

- a) This measurement provides the mean time it takes for the SGSN to establish a PDP context during each collection interval. The measurement is split into subcounters per traffic class per APN (see TS 23.003 for APN definition), these measurements will only be provided for a subset of all APNs. The way the list of monitored APNs is configured is outside the scope of this TS.
- b) DER (n=1).
- c) This measurement is obtained by accumulating the time intervals for each successful mobile originated PDP context activation between the receipt by the SGSN of an "ACTIVATE PDP CONTEXT REQUEST" from the MS and the corresponding transmission by the SGSN to the MS of an "ACTIVATE PDP CONTEXT" message over a granularity period using DER, see TS 29.060, TS 24.008 and TS 23.107 for service class definitions. This end value of the time will then be divided by the number of successful mobile originated PDP context activations observed in the granularity period to give the arithmetic mean, the accumulator shall be reinitialised at the beginning of each granularity period.
- d) Each measurement is an integer value.(in milliseconds).
- e) SM.SuccActPdpContextAPNTimeMOMean.Conv  
SM.SuccActPdpContextAPNTimeMOMean.Strm  
SM.SuccActPdpContextAPNTimeMOMean.Intact  
SM.SuccActPdpContextAPNTimeMOMean.Bgrd.

- f) SgsnFunction, per APN.
- g) Valid for packet switched traffic.
- h) GSM/UMTS.

### 5.6.17 PDP Context set-up time, initiated by MS (Max)

- a) This measurement provides the maximum time it takes for the SGSN to establish a PDP context during each collection interval. The measurement is split into subcounters per traffic class per APN (see TS 23.003 for APN definition), these measurements will only be provided for a subset of all APNs. The way the list of monitored APNs is configured is outside the scope of this TS.
- b) GAUGE.
- c) This measurement is obtained by monitoring the time intervals for each successful mobile originated PDP context activation between the receipt by the SGSN of an "ACTIVATE PDP CONTEXT REQUEST" from the MS and the corresponding transmission by the SGSN to the MS of an "ACTIVATE PDP CONTEXT" message over a granularity period using DER, see TS 29.060, TS 24.008 and TS 23.107 for service class definitions. The high tide mark of this time will be stored in a gauge, the gauge shall be reinitialised at the beginning of each granularity period.
- d) Each measurement is an integer value.(in milliseconds).
- e) SM. SuccActPdpContextAPNTimeMOMax.Conv  
SM. SuccActPdpContextAPNTimeMOMax.Strm  
SM. SuccActPdpContextAPNTimeMOMax.Intact  
SM. SuccActPdpContextAPNTimeMOMax.Bgrd
- f) SgsnFunction, per APN.
- g) Valid for packet switched traffic.
- h) GSM/UMTS.

### 5.6.18 PDP Context set-up time, initiated by Network (Mean)

- a) This measurement provides the mean time it takes for the SGSN to establish a PDP context initiated by the network during each collection interval. The measurement is split into subcounters per traffic class per APN (see TS 23.003 for APN definition), these measurements will only be provided for a subset of all APNs. The way the list of monitored APNs is configured is outside the scope of this TS.
- b) DER (n=1).
- c) This measurement is obtained by accumulating the time intervals for each successful mobile terminated PDP context activation between the transmission by the SGSN of a "REQUEST PDP CONTEXT ACTIVATION" for the MS and the corresponding transmission by the SGSN to the MS of an "ACTIVATE PDP CONTEXT" message over a granularity period using DER, see TS 29.060, TS 24.008 and TS 23.107 for service class definitions. This end value of the time will then be divided by the number of successful mobile originated PDP context activations observed in the granularity period to give the arithmetic mean, the accumulator shall be reinitialised at the beginning of each granularity period.
- d) Each measurement is an integer value.(in milliseconds).
- e) SM. SuccActPdpContextAPNTimeMTMean.Conv  
SM. SuccActPdpContextAPNTimeMTMean.Strm  
SM. SuccActPdpContextAPNTimeMTMean.Intact  
SM. SuccActPdpContextAPNTimeMTMean.Bgrd.
- f) SgsnFunction, per APN.
- g) Valid for packet switched traffic.
- h) GSM/UMTS.

## 5.6.19 PDP Context set-up time, initiated by Network (Max)

- a) This measurement provides the maximum time it takes for the SGSN to establish a PDP context initiated by the network during each collection interval. The measurement is split into subcounters per traffic class per APN (see TS 23.003 for APN definition), these measurements will only be provided for a subset of all APNs. The way the list of monitored APNs is configured is outside the scope of this TS.
- b) GAUGE
- c) This measurement is obtained by monitoring the time intervals for each successful mobile terminated PDP context activation between the transmission by the SGSN of a "REQUEST PDP CONTEXT ACTIVATION" for the MS and the corresponding transmission by the SGSN to the MS of an "ACTIVATE PDP CONTEXT" message over a granularity period using DER, see TS 29.060, TS 24.008 and TS 23.107 for service class definitions. The high tide mark of this time will be stored in a gauge, the gauge shall be reinitialised at the beginning of each granularity period.
- d) Each measurement is an integer value.(in milliseconds).
- e) SM. SuccActPdpContextAPNTimeMTMax.Conv  
SM. SuccActPdpContextAPNTimeMTMax.Strm  
SM. SuccActPdpContextAPNTimeMTMax.Intact  
SM. SuccActPdpContextAPNTimeMTMax.Bgrd.
- f) SgsnFunction, per APN.
- g) Valid for packet switched traffic.
- h) GSM/UMTS.

## 5.7 CAMEL Measurements

### 5.7.1 CAMEL dialogues

#### 5.7.1.1 Attempted CAMEL dialogues

- a) Total number of CAMEL dialogue attempts.  
The three measurement types defined in e) are subject to the "2 out of 3 approach".
- b) CC.
- c) Incremented when a TDP (Trigger Detection Point) is reached and CAP is informed.
- d) A single integer value per measurement type defined in e).
- e) CAM.AttCamelDialogues:
  - CAM.AttCamelDialogues Combined (don't care);
  - CAM.AttCamelDialogues.G GSM;
  - CAM.AttCamelDialogues.U UMTS.
- f) SgsnFunction.
- g) Valid for packet switching.
- h) GSM/UMTS.

#### 5.7.1.2 Failed CAMEL dialogues, aborted locally by gprsSSF

- a) Number of failed CAMEL dialogues, aborted locally by gprsSSF.  
The three measurement types defined in e) are subject to the "2 out of 3 approach".

- b) CC.
- c) Incremented when a CAMEL dialogue is aborted locally by SSF.
- d) A single integer value per measurement type defined in e).
- e) CAM.FailDialoguesSsf:
  - CAM.FailDialoguesSsf Combined (don't care);
  - CAM.FailDialoguesSsf.G GSM;
  - CAM.FailDialoguesSsf.U UMTS.
- f) SgsnFunction.
- g) Valid for packet switching.
- h) GSM/UMTS.

### 5.7.1.3 Failed CAMEL dialogues, error or reject from gsmSCF

- a) Number of failed CAMEL dialogues, error or reject from gsmSCF.  
The three measurement types defined in e) are subject to the "2 out of 3 approach".
- b) CC.
- c) Incremented when a CAMEL dialogue is aborted by SCF.
- d) A single integer value per measurement type defined in e).
- e) CAM.FailDialoguesScf:
  - CAM.FailDialoguesScf Combined (don't care);
  - CAM.FailDialoguesScf.G GSM;
  - CAM.FailDialoguesScf.U UMTS.
- f) SgsnFunction.
- g) Valid for packet switching.
- h) GSM/UMTS.

## 5.8 UMTS-GSM Intersystem Change

### 5.8.1 Intra SGSN inter system changes from UMTS to GSM

#### 5.8.1.1 Attempted intra SGSN inter system changes from UMTS to GSM

- a) Number of attempted intra SGSN inter system changes from UMTS to GSM.
- b) CC.
- c) Receipt of "Routing Area Update REQUEST" message from the MS, where the SGSN determines that it concerns a intra SGSN inter system changes from UMTS to GSM. (TS 24.008).
- d) A single integer value.
- e) ISYSC.AttIntraSgsnUmtsGsmRau.
- f) SgsnFunction.
- g) Valid for packet switching.

h) Combined.

#### 5.8.1.2 Successful intra SGSN inter system changes from UMTS to GSM

- a) Successful intra SGSN inter system changes from UMTS to GSM.
- b) CC.
- c) Transmission of "ROUTING AREA UPDATE ACCEPT" message to the MS (TS 24.008). Only the cases where this message is sent for "UMTS to GSM Intra SGSN Change" are counted.
- d) A single integer value.
- e) ISYSC.SuccIntraSgsnUmtsGsmRau.
- f) SgsnFunction.
- g) Valid for packet switching.
- h) Combined.

#### 5.8.1.3 Failed intra SGSN inter system changes UMTS to GSM RAU, due to internal reasons

- a) Number of failed intra SGSN inter system UMTS to GSM RAU, due to internal reasons.
- b) CC.
- c) "UMTS to GSM Intra SGSN Change" fails due to reasons located inside this 2G+3G-SGSN:- internal resource problem- recovery- ...
- d) A single integer value.
- e) ISYSC.FailIntraSgsnUmtsGsmRauInt.
- f) SgsnFunction.
- g) Valid for packet switching.
- h) Combined.

#### 5.8.1.4 Failed intra SGSN inter system changes UMTS to GSM RAU, due to external reasons

- a) Number of failed intra SGSN inter system UMTS to GSM RAU, due to external reasons.
- b) CC.
- c) "UMTS to GSM Intra SGSN Change" fails due to reasons located in NE outside this 2G+3G-SGSN, such as abnormal (reject, failure,...)/missing responses from SRNS, MSC/VLR, HLR, ...
- d) A single integer value.
- e) ISYSC.FailIntraSgsnUmtsGsmRauExt.
- f) SgsnFunction.
- g) Valid for packet switching.
- h) Combined.

## 5.8.2 Intra SGSN inter system changes from GSM to UMTS

### 5.8.2.1 Attempted intra SGSN inter system changes from GSM to UMTS

- a) Number of attempted intra SGSN inter system changes from GSM to UMTS.
- b) CC.
- c) Receipt of "Routing Area Update REQUEST" message from the MS, where the SGSN determines that it concerns a intra SGSN inter system changes from GSM to UMTS (TS 24.008).
- d) A single integer value.
- e) ISYSC.AttIntraSgsnGsmUmtsRau.
- f) SgsnFunction.
- g) Valid for packet switching.
- h) Combined.

### 5.8.2.2 Successful intra SGSN inter system changes from GSM to UMTS

- a) Successful intra SGSN inter system changes from GSM to UMTS.
- b) CC.
- c) Transmission of "ROUTING AREA UPDATE ACCEPT" message to the MS (TS 24.008). Only the cases where this message is sent for "GSM to UMTS Intra SGSN Change" are counted.
- d) A single integer value.
- e) ISYSC.SuccIntraSgsnGsmUmtsRau.
- f) SgsnFunction.
- g) Valid for packet switching.
- h) Combined.

### 5.8.2.3 Failed intra SGSN inter system changes GSM to UMTS RAU, due to internal reasons

- a) Number of failed intra SGSN inter system GSM to UMTS RAU, due to internal reasons.
- b) CC.
- c) "GSM to UMTS Intra SGSN Change" fails due to reasons located inside this 2G+3G-SGSN:- internal resource problem- recovery- ...
- d) A single integer value.
- e) ISYSC.FailIntraSgsnGsmUmtsRauInt.
- f) SgsnFunction.
- g) Valid for packet switching.
- h) Combined.

### 5.8.2.4 Failed intra SGSN inter system changes GSM to UMTS RAU, due to external reasons

- a) Number of failed intra SGSN inter system GSM to UMTS RAU, due to external reasons.



- b) CC.
- c) "GSM to UMTS Intra SGSN Change" fails due to reasons located in NE outside this 2G+3G-SGSN, such as abnormal (reject, failure,...)/missing responses from SRNS, MSC/VLR, HLR, ...
- d) A single integer value.
- e) ISYSC.FailIntraSgsnGsmUmtsRauExt.
- f) SgsnFunction.
- g) Valid for packet switching.
- h) Combined.

## 5.9 UMTS GTP Measurements

### 5.9.1 GTP-U Iu

#### 5.9.1.1 Number of outgoing GTP data packets on the Iu interface

- a) This measurement provides the number of GTP data PDUs which have been generated by the GTP-U protocol entity on the Iu interface.
- b) CC.
- c) Transmission by the SGSN of a GTP data PDU on the Iu interface to the MS.
- d) A single integer value.
- e) GTP.GtpuOutDataPktIu.
- f) SgsnFunction.
- g) Valid for packet switching.
- h) UMTS.

#### 5.9.1.2 Number of incoming GTP data packets on the Iu interface

- a) This measurement provides the number of GTP data PDUs which have been accepted and processed by the GTP-U protocol entity on the Iu interface.
- b) CC.
- c) Reception by the SGSN of a GTP data PDU on the Iu interface from the MS.
- d) A single integer value.
- e) GTP.GtpuInDataPktIu.
- f) SgsnFunction.
- g) Valid for packet switching.
- h) UMTS.

#### 5.9.1.3 Number of octets of outgoing GTP data packets on the Iu interface

- a) This measurement provides the byte number of outgoing data packets on the Iu interface without the GTP-U header.
- b) CC.

- c) Transmission by the SGSN of an GTP-Data-PDU (T-PDU) on the Iu interface to the MS.
- d) A single integer value.
- e) GTP.GtpuOutDataOctIu.
- f) SgsnFunction.
- g) Valid for packet switching.
- h) UMTS.

#### 5.9.1.4 Number of octets of incoming GTP data packets on the Iu interface

- a) This measurement provides the byte number of incoming data packets on the Iu interface without the GTP-U header.
- b) CC.
- c) Reception by the SGSN of an GTP-Data-PDU (T-PDU) on the Iu interface from the MS.
- d) A single integer value.
- e) GTP.GtpuInDataOctIu.
- f) SgsnFunction.
- g) Valid for packet switching.
- h) UMTS.

### 5.9.2 GTP Gn

#### 5.9.2.1 Number of outgoing GTP data packets on the Gn interface, from SGSN to GGSN

- a) This measurement provides the number of GTP data PDUs which have been generated by the GTP protocol entity on the Gn interface.  
The three measurement types defined in e) are subject to the "2 out of 3 approach".
- b) CC.
- c) Transmission by the SGSN of a GTP data PDU on the Gn interface to the GGSN.
- d) A single integer value per measurement type defined in e).
- e) GTP.OutDataPktGnGGSN:
  - GTP.OutDataPktGnGGSN the total regardless of the GTP version used;
  - GTP.OutDataPktGnGGSN.v0 only the GTPv0 part;
  - GTP.OutDataPktGnGGSN.v1 only the GTPv1 part.
- f) SgsnFunction.
- g) Valid for packet switching.
- h) Combined.

### 5.9.2.2 Number of incoming GTP data packets on the Gn interface, from GGSN to SGSN

- a) This measurement provides the number of GTP Data PDUs which have been accepted and processed by the GTP protocol entity on the Gn interface.  
The three measurement types defined in e) are subject to the "2 out of 3 approach".
- b) CC.
- c) Reception by the SGSN of a GTP data PDU on the Gn interface from the GGSN.
- d) A single integer value per measurement type defined in e).
- e) GTP.InDataPktGnGGSN:
- GTP.InDataPktGnGGSN the total regardless of the GTP version used;
  - GTP.InDataPktGnGGSN.v0 only the GTPv0 part;
  - GTP.InDataPktGnGGSN.v1 only the GTPv1 part.
- f) SgsnFunction.
- g) Valid for packet switching.
- h) Combined.

### 5.9.2.3 Number of octets of outgoing GTP data packets on the Gn interface, from SGSN to GGSN

- a) This measurement provides the number of octets of outgoing GTP data packets on the Gn interface.  
The three measurement types defined in e) are subject to the "2 out of 3 approach".
- b) CC.
- c) Transmission by the SGSN of an GTP-Data-PDU (T-PDU) on the Gn interface to the GGSN.
- d) A single integer value per measurement type defined in e).
- e) GTP.OutDataOctGnGGSN:
- GTP.OutDataOctGnGGSN the total regardless of the GTP version used;
  - GTP.OutDataOctGnGGSN.v0 only the GTPv0 part;
  - GTP.OutDataOctGnGGSN.v1 only the GTPv1 part.
- f) SgsnFunction.
- g) Valid for packet switching.
- h) Combined.

### 5.9.2.4 Number of octets of incoming GTP data packets on the Gn interface, from GGSN to SGSN

- a) This measurement provides the number of octets of incoming GTP data packets on the Gn interface.  
The three measurement types defined in e) are subject to the "2 out of 3 approach".
- b) CC.
- c) Reception by the SGSN of an GTP-Data-PDU (T-PDU) on the Gn interface from the GGSN.
- d) A single integer value per measurement type defined in e).
- e) GTP.InDataOctGnGGSN:

- GTP.InDataOctGnGGSN the total regardless of the GTP version used;
- GTP.InDataOctGnGGSN.v0 only the GTPv0 part;
- GTP.InDataOctGnGGSN.v1 only the GTPv1 part.

f) SgsnFunction.

g) Valid for packet switching.

h) Combined.

#### 5.9.2.5 Number of outgoing GTP signalling packets on the Gn interface, from SGSN to GGSN

a) This measurement provides the number of GTP signalling PDUs which have been generated by the GTP protocol entity on the Gn interface.  
The three measurement types defined in e) are subject to the "2 out of 3 approach".

b) CC.

c) Transmission by the SGSN of a GTP signalling PDU on the Gn interface to the GGSN.

d) A single integer value per measurement type defined in e).

e) GTP.OutSigPktGnGGSN:

- GTP.OutSigPktGnGGSN the total regardless of the GTP version used;
- GTP.OutSigPktGnGGSN.v0 only the GTPv0 part;
- GTP.OutSigPktGnGGSN.v1 only the GTPv1 part.

f) SgsnFunction.

g) Valid for packet switching.

h) Combined.

#### 5.9.2.6 Number of incoming GTP signalling packets on the Gn interface, from GGSN to SGSN

a) This measurement provides the number of GTP signalling PDUs which have been accepted and processed by the GTP protocol entity on the Gn interface.  
The three measurement types defined in e) are subject to the "2 out of 3 approach".

b) CC.

c) Reception by the SGSN of a GTP signalling PDU on the Gn interface from the GGSN.

d) A single integer value per measurement type defined in e).

e) GTP.InSigPktGnGGSN:

- GTP.InSigPktGnGGSN the total regardless of the GTP version used;
- GTP.InSigPktGnGGSN.v0 only the GTPv0 part;
- GTP.InSigPktGnGGSN.v1 only the GTPv1 part.

f) SgsnFunction.

g) Valid for packet switching.

h) Combined.

### 5.9.2.7 Number of octets of outgoing GTP signalling packets on the Gn interface, from SGSN to GGSN

- a) This measurement provides the number of octets of outgoing GTP signalling packets on the Gn interface. The three measurement types defined in e) are subject to the "2 out of 3 approach".
- b) CC.
- c) Transmission by the SGSN of an GTP-Signalling-PDU on the Gn interface to the GGSN.
- d) A single integer value per measurement type defined in e).
- e) GTP.OutSigOctGnGGSN:
  - GTP.OutSigOctGnGGSN the total regardless of the GTP version used;
  - GTP.OutSigOctGnGGSN.v0 only the GTPv0 part;
  - GTP.OutSigOctGnGGSN.v1 only the GTPv1 part.
- f) SgsnFunction.
- g) Valid for packet switching.
- h) Combined.

### 5.9.2.8 Number of octets of incoming GTP signalling packets on the Gn interface, from GGSN to SGSN

- a) This measurement provides the number of octets of incoming GTP signalling packets on the Gn interface. The three measurement types defined in e) are subject to the "2 out of 3 approach".
- b) CC.
- c) Reception by the SGSN of an GTP-Signalling-PDU on the Gn interface from the GGSN.
- d) A single integer value per measurement type defined in e).
- e) GTP.InSigOctGnGGSN:
  - GTP.InSigOctGnGGSN the total regardless of the GTP version used;
  - GTP.InSigOctGnGGSN.v0 only the GTPv0 part;
  - GTP.InSigOctGnGGSN.v1 only the GTPv1 part.
- f) SgsnFunction.
- g) Valid for packet switching.
- h) Combined.

### 5.9.2.9 Number of outgoing GTP data packets on the Gn interface, from SGSN to SGSN

- a) This measurement provides the number of GTP data PDUs which have been generated by the GTP protocol entity on the Gn interface. The three measurement types defined in e) are subject to the "2 out of 3 approach".
- b) CC.
- c) Transmission by the SGSN of a GTP data PDU on the Gn interface to the SGSN.
- d) A single integer value per measurement type defined in e).

- e) GTP.OutDataPktGnSGSN:
  - GTP.OutDataPktGnSGSN the total regardless of the GTP version used;
  - GTP.OutDataPktGnSGSN.v0 only the GTPv0 part;
  - GTP.OutDataPktGnSGSN.v1 only the GTPv1 part.
- f) SgsnFunction.
- g) Valid for packet switching.
- h) Combined.

#### 5.9.2.10 Number of incoming GTP data packets on the Gn interface, from SGSN to SGSN

- a) This measurement provides the number of GTP Data PDUs which have been accepted and processed by the GTP protocol entity on the Gn interface.  
The three measurement types defined in e) are subject to the "2 out of 3 approach".
- b) CC.
- c) Reception by the SGSN of a GTP data PDU on the Gn interface from the SGSN.
- d) A single integer value per measurement type defined in e).
- e) GTP.InDataPktGnSGSN:
  - GTP.InDataPktGnSGSN the total regardless of the GTP version used;
  - GTP.InDataPktGnSGSN.v0 only the GTPv0 part;
  - GTP.InDataPktGnSGSN.v1 only the GTPv1 part.
- f) SgsnFunction.
- g) Valid for packet switching.
- h) Combined.

#### 5.9.2.11 Number of octets of outgoing GTP data packets on the Gn interface, from SGSN to SGSN

- a) This measurement provides the number of octets of outgoing GTP data packets on the Gn interface.  
The three measurement types defined in e) are subject to the "2 out of 3 approach".
- b) CC.
- c) Transmission by the SGSN of an GTP-Data-PDU (T-PDU) on the Gn interface to the SGSN.
- d) A single integer value per measurement type defined in e).
- e) GTP.OutDataOctGnSGSN:
  - GTP.OutDataOctGnSGSN the total regardless of the GTP version used;
  - GTP.OutDataOctGnSGSN.v0 only the GTPv0 part;
  - GTP.OutDataOctGnSGSN.v1 only the GTPv1 part.
- f) SgsnFunction.
- g) Valid for packet switching.

h) Combined.

#### 5.9.2.12 Number of octets of incoming GTP data packets on the Gn interface, from SGSN to SGSN

- a) This measurement provides the number of octets of incoming GTP data packets on the Gn interface. The three measurement types defined in e) are subject to the "2 out of 3 approach".
- b) CC.
- c) Reception by the SGSN of an GTP-Data-PDU (T-PDU) on the Gn interface from the SGSN.
- d) A single integer value per measurement type defined in e).
- e) GTP.InDataOctGnSGSN:
  - GTP.InDataOctGnSGSN the total regardless of the GTP version used;
  - GTP.InDataOctGnSGSN.v0 only the GTPv0 part;
  - GTP.InDataOctGnSGSN.v1 only the GTPv1 part.
- f) SgsnFunction.
- g) Valid for packet switching.
- h) Combined.

#### 5.9.2.13 Number of outgoing GTP signalling packets on the Gn interface, from SGSN to SGSN

- a) This measurement provides the number of GTP signalling PDUs which have been generated by the GTP protocol entity on the Gn interface. The three measurement types defined in e) are subject to the "2 out of 3 approach".
- b) CC.
- c) Transmission by the SGSN of a GTP signalling PDU on the Gn interface to the SGSN.
- d) A single integer value per measurement type defined in e).
- e) GTP.OutSigPktGnSGSN:
  - GTP.OutSigPktGnSGSN the total regardless of the GTP version used;
  - GTP.OutSigPktGnSGSN.v0 only the GTPv0 part;
  - GTP.OutSigPktGnSGSN.v1 only the GTPv1 part.
- f) SgsnFunction.
- g) Valid for packet switching.
- h) Combined.

#### 5.9.2.14 Number of incoming GTP signalling packets on the Gn interface, from SGSN to SGSN

- a) This measurement provides the number of GTP signalling PDUs which have been accepted and processed by the GTP protocol entity on the Gn interface. The three measurement types defined in e) are subject to the "2 out of 3 approach".
- b) CC.

- c) Reception by the SGSN of a GTP signalling PDU on the Gn interface from the SGSN.
- d) A single integer value per measurement type defined in e).
- e) GTP.InSigPktGnSGSN:
  - GTP.InSigPktGnSGSN the total regardless of the GTP version used;
  - GTP.InSigPktGnSGSN.v0 only the GTPv0 part;
  - GTP.InSigPktGnSGSN.v1 only the GTPv1 part.
- f) SgsnFunction.
- g) Valid for packet switching.
- h) Combined.

#### 5.9.2.15 Number of octets of outgoing GTP signalling packets on the Gn interface, from SGSN to SGSN

- a) This measurement provides the number of octets of outgoing GTP signalling packets on the Gn interface. The three measurement types defined in e) are subject to the "2 out of 3 approach".
- b) CC.
- c) Transmission by the SGSN of an GTP-Signalling-PDU on the Gn interface to the SGSN.
- d) A single integer value per measurement type defined in e).
- e) GTP.OutSigOctGnSGSN:
  - GTP.OutSigOctGnSGSN the total regardless of the GTP version used;
  - GTP.OutSigOctGnSGSN.v0 only the GTPv0 part;
  - GTP.OutSigOctGnSGSN.v1 only the GTPv1 part.
- f) SgsnFunction.
- g) Valid for packet switching.
- h) Combined.

#### 5.9.2.16 Number of octets of incoming GTP signalling packets on the Gn interface, from SGSN to SGSN

- a) This measurement provides the number of octets of incoming GTP signalling packets on the Gn interface. The three measurement types defined in e) are subject to the "2 out of 3 approach".
- b) CC.
- c) Reception by the SGSN of an GTP-Signalling-PDU on the Gn interface from the SGSN.
- d) A single integer value per measurement type defined in e).
- e) GTP.InSigOctGnSGSN:
  - GTP.InSigOctGnSGSN the total regardless of the GTP version used;
  - GTP.InSigOctGnSGSN.v0 only the GTPv0 part;
  - GTP.InSigOctGnSGSN.v1 only the GTPv1 part.



- f) SgsnFunction.
- g) Valid for packet switching.
- h) Combined.

## 5.10 UMTS Bearer Service

### 5.10.1 UMTS Bearer Service CS time to register (Mean)

- a) This measurement provides the mean time it takes for the subscribers to register with the network for circuit switched (CS) services during each granularity period.
- b) DER (n=1)
- c) This measurement is obtained by accumulating the time intervals for each successful attach between the receipt by the VLR of an "ATTACH REQUEST" from the MS and the corresponding receipt by the VLR of an "ATTACH COMPLETE" message over a granularity period using DER, see TS 24.008. This end value of the time will then be divided by the number of successful attach requests for CS domain observed in the granularity period to give the arithmetic mean, the accumulator shall be reinitialised at the beginning of each granularity period.
- d) Each measurement is an integer value.(in milliseconds).
- e) UBS.TimeToRegisterCSMean
- f) VlrFunction
- g) Valid for circuit switched traffic.
- h) UMTS.

### 5.10.2 UMTS Bearer Service CS time to register (Max)

- a) This measurement provides the maximum time it takes for the subscribers to register with the network for circuit switched (CS) services during each granularity period.
- b) GAUGE.
- c) This measurement is obtained by monitoring the time intervals for each successful attach between the receipt by the VLR of an "ATTACH REQUEST" from the MS and the corresponding receipt by the VLR of an "ATTACH COMPLETE" message over a granularity period, see TS 24.008. The high tide mark of this time will be stored in a gauge, the gauge shall be reinitialised at the beginning of each granularity period.
- d) Each measurement is an integer value.(in milliseconds).
- e) UBS.TimeToRegisterCSMax.
- f) VlrFunction.
- g) Valid for circuit switched traffic.
- h) UMTS.

### 5.10.3 UMTS Bearer Service PS time to register (Mean)

- a) This measurement provides the mean time it takes for the subscribers to register with the network for packet switched (PS) services during each granularity period.
- b) DER (n=1).
- c) This measurement is obtained by accumulating the time intervals for each successful attach between the receipt by the SGSN of an "ATTACH REQUEST" from the MS and the corresponding receipt by the SGSN of an

"ATTACH COMPLETE" message over a granularity period using DER, see TS 24.008. This end value of the time will then be divided by the number of successful attach requests for PS domain observed in the granularity period to give the arithmetic mean.

- d) Each measurement is an integer value.(in milliseconds).
- e) UBS.TimeToRegisterPSMean.
- f) SgsnFunction.
- g) Valid for packet switched traffic.
- h) UMTS.

#### 5.10.4 UMTS Bearer Service PS time to register (Max)

- a) This measurement provides the maximum time it takes for the subscribers to register with the network for packet switched (PS) services during each granularity period.
- b) GAUGE.
- c) This measurement is obtained by monitoring the time intervals for each successful attach between the receipt by the SGSN of an "ATTACH REQUEST" from the MS and the corresponding receipt by the SGSN of an "ATTACH COMPLETE" message over a granularity period using DER, see TS 24.008. The high tide mark of this time will be stored in a gauge, the gauge shall be reinitialised at the beginning of each granularity period.
- d) Each measurement is an integer value.(in milliseconds).
- e) UBS.TimeToRegisterPSMax.
- f) SgsnFunction.
- g) Valid for packet switched traffic.
- h) UMTS.

#### 5.10.5 UMTS Bearer Service time to establish Communications Management (CM) radio access connectivity (Mean)

- a) This measurement provides the mean time it takes for the radio access network to establish a service connection (for circuit switched connection establishment, supplementary services activation, short message transfer, location services) during each granularity period.
- b) DER (n=1).
- c) This measurement is obtained by accumulating the time intervals for each successful service request between the receipt by the MSC of a "CM SERVICE REQUEST" from the MS and the corresponding receipt by the MSC of an "CM SERVICE ACCEPT" message over a granularity period using DER, see TS 24.008. This end value of the time will then be divided by the number of successful service requests observed in the granularity period to give the arithmetic mean, the accumulator shall be reinitialised at the beginning of each granularity period.
- d) Each measurement is an integer value.(in milliseconds).
- e) UBS.TimeForCMConnectRANMean.
- f) MscFunction.
- g) Valid for circuit switched traffic.
- h) UMTS.

## 5.10.6 UMTS Bearer Service time to establish Communications Management (CM) radio access connectivity (Max)

- a) This measurement provides the maximum time it takes for the radio access network to establish a service connection (for circuit switched connection establishment, supplementary services activation, short message transfer, location services) during each granularity period.
- b) GAUGE.
- c) This measurement is obtained by monitoring the time intervals for each successful service request between the receipt by the MSC of a "CM SERVICE REQUEST" from the MS and the corresponding receipt by the MSC of an "CM SERVICE ACCEPT" message over a granularity period, see TS 24.008. The high tide mark of this time will be stored in a gauge, the gauge shall be reinitialised at the beginning of each granularity period.
- d) Each measurement is an integer value.(in milliseconds).
- e) UBS.TimeForCMConnectRANMax
- f) MscFunction.
- g) Valid for circuit switched traffic.
- h) UMTS.

## 5.11 LLC frames

### 5.11.1 Number of LLC frames sent

- f) This measurement provides the number of LLC frames sent by the SGSN.
- g) CC.
- h) Transmission of a LLC frame to a peer entity (TS 44.064 [27]).
- i) A single integer value
- j) LLC.NbrFramesSent.
- k) SgsnFunction.
- l) Valid for packet switching.
- m) GSM.

### 5.11.2 Number of LLC frames received

- a) This measurement provides the number of LLC frames received by the SGSN.
- b) CC.
- c) Receipt of a LLC frame from a peer entity before any error checking (TS 44.064 [27]).
- d) A single integer value
- e) LLC.NbrFramesReceived.
- f) SgsnFunction.
- g) Valid for packet switching.
- h) GSM.

### 5.11.3 Number of erroneous LLC frames received

- a) This measurement provides the number of erroneous LLC frames received by the SGSN.
- b) CC.
- c) Discard of an erroneous LLC frame received from a peer entity (TS 44.064 [27]).
- d) A single integer value
- e) LLC.NbrErroneousFrames.
- f) SgsnFunction.
- g) Valid for packet switching.
- h) GSM.

### 5.11.4 Number of LLC frames retransmitted

- a) This measurement provides the number of LLC frames retransmitted in LLC acknowledge mode by the SGSN.
- b) CC.
- c) Receipt of a NACK or SACK frame from a peer entity (TS 44.064 [27]).
- d) A single integer value
- e) LLC.NbrFramesRetransmitted.
- f) SgsnFunction.
- g) Valid for packet switching.
- h) GSM.

## 5.12 SNDCCP N-PDUs

### 5.12.1 Number of SNDCCP N-PDUs sent

- a) This measurement provides the number of SNDCCP N-PDUs sent by the SGSN.
- b) CC.
- c) Transmission of a SN-DATA or SN-UNITDATA request (TS 44.065 [28]).
- d) A single integer value
- e) SNDCCP.NbrNpdusSent.
- f) SgsnFunction.
- g) Valid for packet switching.
- h) GSM.

### 5.12.2 Number of SNDCCP N-PDU octets sent

- a) This measurement provides the number of octets in SNDCCP N-PDUs sent by the SGSN.
- b) CC.
- c) Transmission of a SN-DATA or SN-UNITDATA request (TS 44.065 [28]).

- d) A single integer value
- e) SNDTCP.NbrNpduOctetsSent.
- f) SgsnFunction.
- g) Valid for packet switching.
- h) GSM.

### 5.12.3 Number of SNDTCP N-PDUs received

- a) This measurement provides the number of SNDTCP N-PDUs received by the SGSN.
- b) CC.
- c) Receipt of a SN-DATA or SN-UNITDATA indication (TS 44.065 [28]).
- d) A single integer value
- e) SNDTCP.NbrNpdusReceived.
- f) SgsnFunction.
- g) Valid for packet switching.
- h) GSM.

### 5.12.4 Number of SNDTCP N-PDU octets received

- a) This measurement provides the number of octets in SNDTCP N-PDUs received by the SGSN.
- b) CC.
- c) Receipt of a SN-DATA or SN-UNITDATA indication (TS 44.065 [28]).
- d) A single integer value
- e) SNDTCP.NbrNpduOctetsReceived.
- f) SgsnFunction.
- g) Valid for packet switching.
- h) GSM.

## 5.13 IMEI checking procedure

### 5.13.1 Number of check IMEI requests

- n) This measurement provides the number of check IMEI requests sent to the EIR.  
The three measurement types defined in e) are subject to the "2 out of 3 approach".
- o) CC.
- p) Transmission of a "MAP\_CHECK\_IMEI" request to the EIR (TS 29.002 [18]).
- q) A single integer value.
- r) IMEI.CheckImeiReq.
- s) SgsnFunction.
- t) Valid for packet switching.

- u) Combined.

### 5.13.2 Number of check IMEI white list responses

- a) This measurement provides the number of check IMEI white list responses received from the EIR. The three measurement types defined in e) are subject to the "2 out of 3 approach".
- b) CC.
- c) Receipt of a "MAP\_CHECK\_IMEI" response from the EIR with parameter "equipment status" indicating a white listed equipment (TS 29.002 [18]).
- d) A single integer value.
- e) IMEI.CheckImeiRspWhite.
- f) SgsnFunction.
- g) Valid for packet switching.
- h) Combined.

### 5.13.3 Number of check IMEI grey list responses

- a) This measurement provides the number of check IMEI grey list responses received from the EIR. The three measurement types defined in e) are subject to the "2 out of 3 approach".
- b) CC.
- c) Receipt of a "MAP\_CHECK\_IMEI" response from the EIR with parameter "equipment status" indicating a grey listed equipment (TS 29.002 [18]).
- d) A single integer value.
- e) IMEI.CheckImeiRspGrey.
- f) SgsnFunction.
- g) Valid for packet switching.
- h) Combined.

### 5.13.4 Number of check IMEI black list responses

- a) This measurement provides the number of check IMEI black list responses received from the EIR. The three measurement types defined in e) are subject to the "2 out of 3 approach".
- b) CC.
- c) Receipt of a "MAP\_CHECK\_IMEI" response from the EIR with parameter "equipment status" indicating a black listed equipment (TS 29.002 [18]).
- d) A single integer value.
- e) IMEI.CheckImeiRspBlack.
- f) SgsnFunction.
- g) Valid for packet switching.
- h) Combined.

### 5.13.5 Number of check IMEI unknown equipment responses

- a) This measurement provides the number of check IMEI unknown equipment responses received from the EIR. The three measurement types defined in e) are subject to the "2 out of 3 approach".
- b) CC.
- c) Receipt of a "MAP\_CHECK\_IMEI" response from the EIR with parameter "user error" indicating an unknown equipment (TS 29.002 [18]).
- d) A single integer value.
- e) IMEI.CheckImeiRspUnknown.
- f) SgsnFunction.
- g) Valid for packet switching.
- h) Combined.

---

## 6 Measurements related to the GGSN

### 6.1 Session Management

#### 6.1.1 Session establishments

The performance counters presented in this subclause are mainly intended to:

- monitor the session establishment success at the GGSN level;
- identify the main causes for GGSN originating session establishment failures;
- and study the repartition of the different traffic classes within session establishment attempts and successes.

These counters are associated to GPRS Tunnelling Protocol signalling (GTP-C for the control plane), between the SGSN and the GGSN, and defined in TS 23.060 and TS 29.060.

The figure below, from TS 23.060, recalls the sequence of messages exchanged for a primary PDP context activation and a subsequent secondary PDP context activation and details the events triggering the update of the counters values.

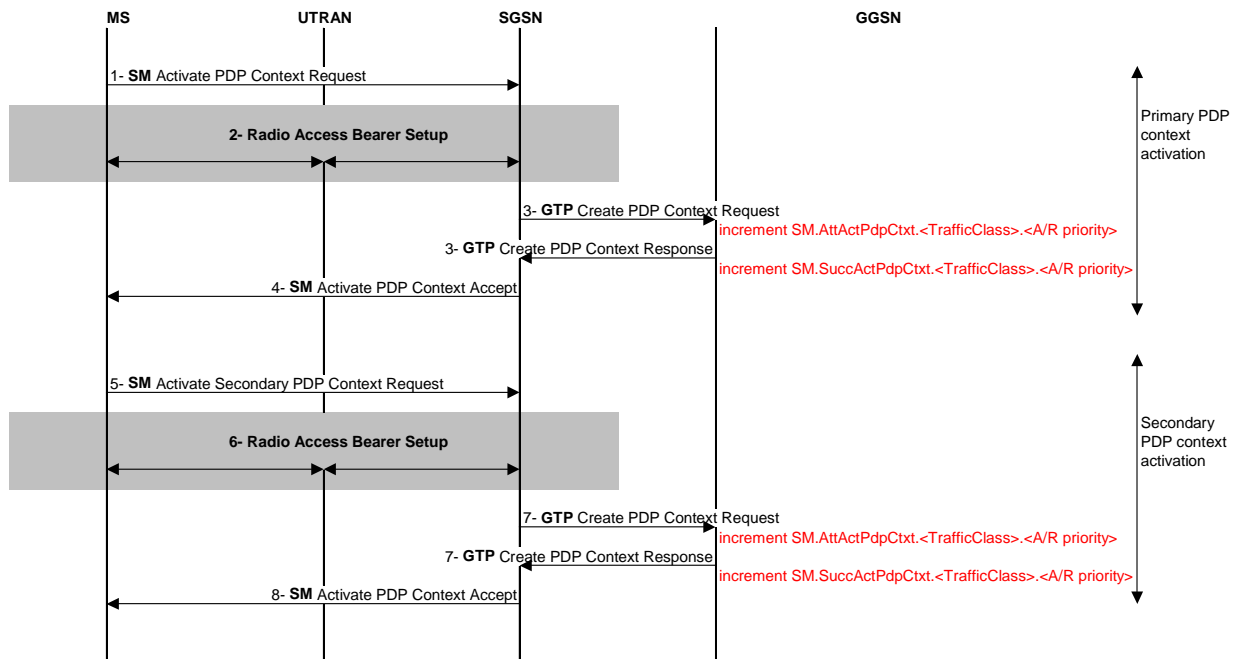

Figure from TS 23.060

The three measurement types defined in the clause 6.1.1 are subject to the "2 out of 3 approach".

### 6.1.1.1 Attempted session establishments

- This measurement provides the number of attempted session establishments. This measurement is split into subcounters per traffic class and allocation/retention priority (or precedence class) indicated in the QoS profile.
- CC.
- On receipt of a CREATE PDP CONTEXT REQUEST message by the GGSN, the relevant measurement is incremented according to the traffic class and allocation/retention priority (or precedence class) indicated in the message. In case of a PDP context activated with R97/98 QoS attributes, the fields traffic class and allocation/retention priority used for screening are derived from delay class and precedence class respectively, as ruled in TS 23.107. See also TS 24.008 and TS 29.060.
- A single integer value per measurement type defined in e).
- SM.AttActPdpCtxt.Bgrd.Low
  - SM.AttActPdpCtxt.Conv.Low
  - SM.AttActPdpCtxt.Intact.Low
  - SM.AttActPdpCtxt.Strm.Low
  - SM.AttActPdpCtxt.Bgrd.High
  - SM.AttActPdpCtxt.Conv.High
  - SM.AttActPdpCtxt.Intact.High
  - SM.AttActPdpCtxt.Strm.High
  - SM.AttActPdpCtxt.Bgrd.Medium
  - SM.AttActPdpCtxt.Conv.Medium
  - SM.AttActPdpCtxt.Intact.Medium
  - SM.AttActPdpCtxt.Strm.Medium.
- GgsnFunction.
- Valid for packet switched traffic.
- COMB.
- This measurement is mainly dedicated to Operator Business and Vendor Performance Modelling communities.



### 6.1.1.2 Successful session establishments

- a) This measurement provides the number of sessions successfully established. This measurement is split into subcounters per traffic class and allocation/retention priority (or precedence class) given in the QoS profile of the related PDP context.
- b) CC.
- c) The relevant measurement is incremented on transmission by the GGSN of a CREATE PDP CONTEXT RESPONSE message sent with cause "Request Accepted", according to the traffic class and allocation/retention priority of the related PDP context. In case of a PDP context activated with R97/98 QoS attributes, the fields traffic class and allocation/retention priority used for screening are derived from delay class and precedence class respectively, as ruled in TS 23.107. See also TS 24.008 and TS 29.060.
- d) A single integer value per measurement type defined in e).
- e) SM.SuccActPdpCtxt.Bgrd.Low  
SM.SuccActPdpCtxt.Conv.Low  
SM.SuccActPdpCtxt.Intact.Low  
SM.SuccActPdpCtxt.Strm.Low  
SM.SuccActPdpCtxt.Bgrd.High  
SM.SuccActPdpCtxt.Conv.High  
SM.SuccActPdpCtxt.Intact.High  
SM.SuccActPdpCtxt.Strm.High  
SM.SuccActPdpCtxt.Bgrd.Medium  
SM.SuccActPdpCtxt.Conv.Medium  
SM.SuccActPdpCtxt.Intact.Medium  
SM.SuccActPdpCtxt.Strm.Medium.
- f) GgsnFunction.
- g) Valid for packet switched traffic.
- h) COMB.
- i) This measurement is mainly dedicated to Operator Business and Vendor Performance Modelling communities.

### 6.1.1.3 Failed session establishments

- a) This measurement provides the number of session establishment failures. This measurement is split into subcounters per failure cause.
- b) CC.
- c) On transmission by the GGSN of a CREATE PDP CONTEXT RESPONSE message indicating a PDP context activation failure, the measurement is incremented according to the failure cause. Possible causes are included in TS 29.060. The sum of all supported per cause measurements should equal the total number of PDP context activation failures.
- d) Each measurement is an integer value. The number of measurements is equal to the number of causes supported.
- e) The measurement name has the form SM.FailActPdpCtxt.Cause where Cause identifies the failure cause.
- f) GgsnFunction.
- g) Valid for packet switched traffic.
- h) COMB.
- i) This measurement is mainly dedicated to Operator Maintenance and Vendor Performance Modelling communities.

## 6.1.2 Network-initiated session establishments

The performance counters presented in this subclause focus on network initiated PDP context activation procedure, that allows the GGSN to initiate the activation of a PDP context on receipt of a PDP PDU on the Gi interface. The counters proposed are mainly intended to

- monitor the signalling exchanged between the HLR and the GGSN during this procedure; and
- monitor the success rate for network-initiated session establishments. It has to be noted that measurements proposed enable to distinguish between the establishment failures occurring before and after the SGSN has sent the context activation request to the MS.

These counters are associated to the Mobile Application Part (MAP) protocol layer (defined in TS 29.002) and to GPRS Tunnelling Protocol signalling (GTP-C for the control plane), between the SGSN and the GGSN (defined in TS 29.060).

The figure below, from TS 23.060, recalls the sequence of messages exchanged for a network initiated PDP context activation and details the events triggering the update of the counters values.

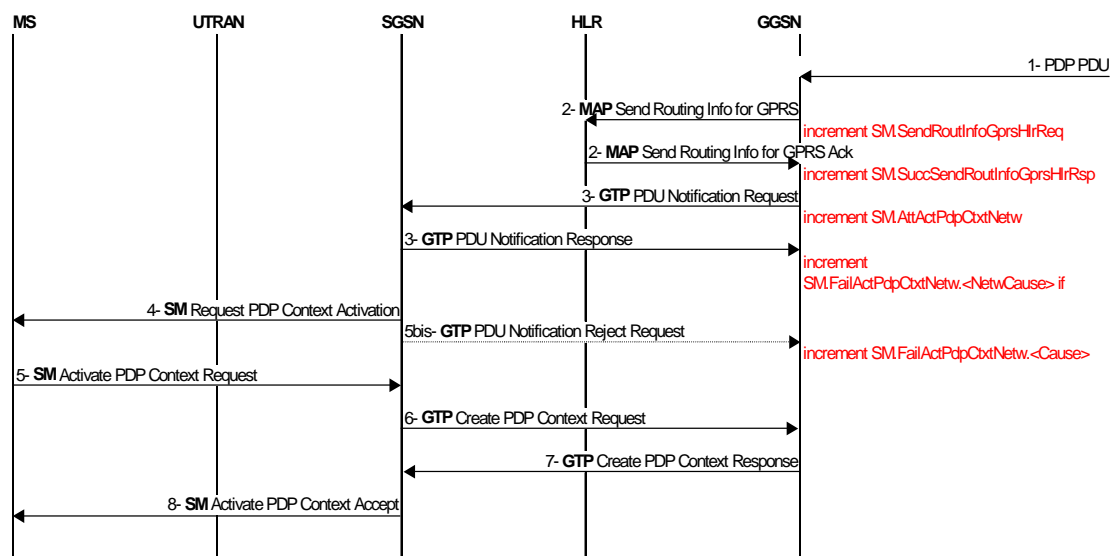

Figure from TS 23.06

### 6.1.2.1 Number of routing information requests for network-initiated session establishment attempts

- This measurement provides the number of «Send Routing Info for GPRS » requests sent to the HLR.
- CC.
- The measurement is incremented on transmission by the GGSN of a MAP SEND ROUTING INFO FOR GPRS message to the HLR. See TS 23.060 and TS 29.002.
- Integer.
- SM.SendRoutInfoGprsHlrReq.
- GgsnFunction.
- Valid for packet switched traffic.
- COMB.
- This measurement is mainly dedicated to Vendor Performance Modelling community.

### 6.1.2.2 Number of routing information successful responses for network-initiated session establishment attempts

- a) This measurement provides the number of "Send Routing Info for GPRS" response messages received from HLR indicating a positive outcome.
- b) CC.
- c) The measurement is incremented on receipt by the GGSN of a MAP SEND ROUTING INFO FOR GPRS response message containing an SGSN address, which indicates a successful outcome. See TS 23.060 and TS 29.002.
- d) Integer.
- e) SM.SuccSendRoutInfoGprsHlrRsp.
- f) GgsnFunction.
- g) Valid for packet switched traffic.
- h) COMB.
- i) This measurement is mainly dedicated to Vendor Performance Modelling and Operator Maintenance communities.

### 6.1.2.3 Attempted Network-initiated session establishments

#### 6.1.2.3.1 Attempted Network-initiated session establishments

- a) This measurement provides the number of network-initiated session establishments attempted. Only the session establishment attempts for which a successful routing response from the HLR has been received are counted (i.e. for which a response including an SGSN address).
- b) CC.
- c) The measurement is incremented on transmission by the GGSN of a PDU NOTIFICATION REQUEST message to the SGSN. See TS 23.060 and TS 29.060.
- d) Integer.
- e) SM.AttActPdpCtxtNetw.
- f) GgsnFunction.
- g) Valid for packet switched traffic.
- h) COMB.
- i) This measurement is mainly dedicated to Vendor Performance Modelling community.

#### 6.1.2.3.2 Failed Network-initiated session establishments - failures occurred before sending PDP context activation request to the MS

- a) This measurement provides the number of network initiated session establishment failures. This measurement is split into subcounters per failure cause.
- b) CC.
- c) On receipt by the GGSN of a PDU NOTIFICATION RESPONSE message with cause different from "Request Accepted", indicating a PDP context activation failure, the relevant measurement is incremented according to the failure cause. Possible causes are included in TS 29.060. The sum of all supported per cause measurements should equal the total number of PDP context activation failures occurred before sending REQUEST PDP CONTEXT ACTIVATION message to the MS.
- d) Each measurement is an integer value. The number of measurements is equal to the number of causes supported.

- e) The measurement name has the form SM.FailActPdpCtxtNetw.NetwCause where NetwCause identifies the failure cause.
- f) GgsnFunction.
- g) Valid for packet switched traffic.
- h) COMB.
- i) This measurement is mainly dedicated to Vendor Performance Modelling and Operator Maintenance communities.

#### 6.1.2.3.3 Failed Network-initiated session establishments - failures occurred after sending PDP context activation request to the MS

- a) This measurement provides the number of network initiated session establishment failures. This measurement is split into subcounters per failure cause.
- b) CC.
- c) On receipt by the GGSN of a PDU NOTIFICATION REJECT REQUEST, the relevant measurement is incremented according to the failure cause. Possible causes are included in TS 29.060. The sum of all supported per cause measurements should equal the total number of PDP context activation failures occurred after sending REQUEST PDP CONTEXT ACTIVATION message to the MS.
- d) Each measurement is an integer value. The number of measurements is equal to the number of causes supported.
- e) The measurement name has the form SM.FailActPdpCtxtNetw.MsCause where MsCause identifies the failure cause.
- f) GgsnFunction.
- g) Valid for packet switched traffic.
- h) COMB.
- i) This measurement is mainly dedicated to Vendor Performance Modelling and Operator Maintenance communities.

### 6.1.3 Subscribers with activated PDP context

The performance counters presented in this subclause are mainly intended to establish a subscriber profile. Such a profile details the number of elementary procedures per active subscriber (PDP context activations, modifications, updates, ...), usually during a busy hour. This profile may be used for 2 main purposes:

- to estimate the current load of the equipment, with details on the respective weight of each procedure in the overall load;
- to estimate the impact on the equipment of a modification of a factor in this subscriber profile (e.g. increase of the number of simultaneous active PDP contexts per subscriber, increase of the number of subscribers, ...).

#### 6.1.3.1 Number of subscribers with activated PDP context

- a) This measurement provides the number of subscribers having an activated PDP context.
- b) GAUGE.
- c) The measurement is incremented on transmission by the GGSN of a CREATE PDP CONTEXT RESPONSE message with cause "Request Accepted" for an MSISDN that had no PDP context already activated. The measurement is decremented on transmission by the GGSN of a DELETE PDP CONTEXT RESPONSE message with cause "Request Accepted" related to the last PDP context for an MSISDN. See TS 29.060 and TS 23.060.
- d) A single integer value.

- e) SM.NbrActSubs.
- f) GgsnFunction.
- g) Valid for packet switched traffic.
- h) Combined.
- i) This measurement is mainly dedicated to Operator Business and Vendor Performance Modelling communities.

#### 6.1.3.2 Mean number of subscribers with activated PDP context

- a) This measurement provides the mean number of subscribers having an activated PDP context.
- b) SI.
- c) This measurement is obtained by sampling at a pre-defined interval the number of subscribers having an activated PDP context in the GGSN and then taking the arithmetic mean.
- d) A single integer value.
- e) SM.MeanActSubs.
- f) GgsnFunction.
- g) Valid for packet switched traffic.
- h) Combined.
- i) This measurement is mainly dedicated to Operator Business and Vendor Performance Modelling communities.

#### 6.1.3.3 Max number of subscribers with activated PDP context

- a) This measurement provides the maximum number of subscribers having an activated PDP context.
- b) SI.
- c) This measurement is obtained by sampling at a pre-defined interval the number of subscribers having an activated PDP context in the GGSN and then taking the maximum.
- d) A single integer value.
- e) SM.MaxActSubs.
- f) GgsnFunction.
- g) Valid for packet switched traffic.
- h) Combined.
- i) This measurement is mainly dedicated to Operator Business and Vendor Performance Modelling communities.

#### 6.1.4 Session conclusions

The performance counters presented in this subclause are related to PDP context deactivation procedure. The counters proposed are mainly intended to evaluate the ratio of GGSN-initiated PDP context deactivations in overall PDP context deactivations, estimate the PDP context deactivation success rate, and may also be used in the subscriber or session profile.

The figures below, from TS 23.060, recall the sequence of messages exchanged for MS, SGSN or GGSN initiated PDP context deactivations and detail the events triggering the update of the counters values.

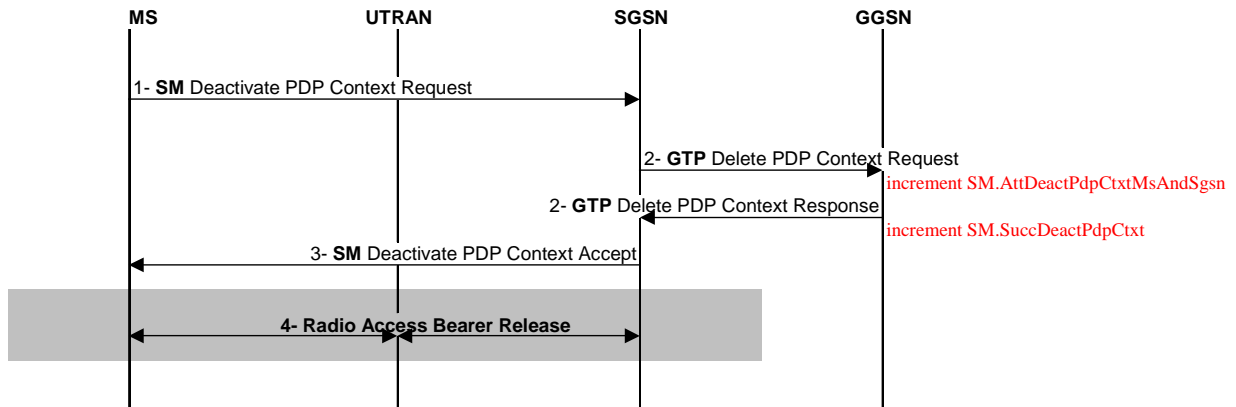

Figure: MS initiated PDP context deactivation

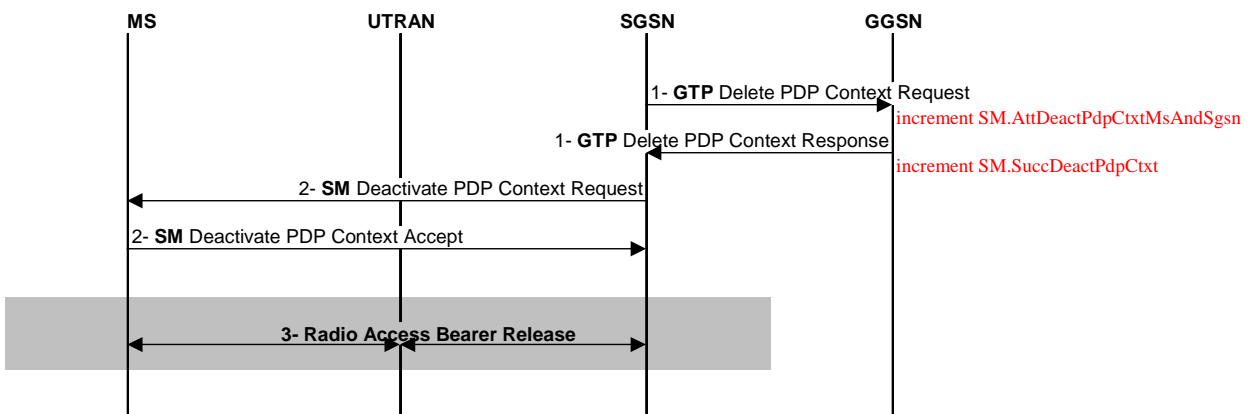

Figure: GSN initiated PDP context deactivation

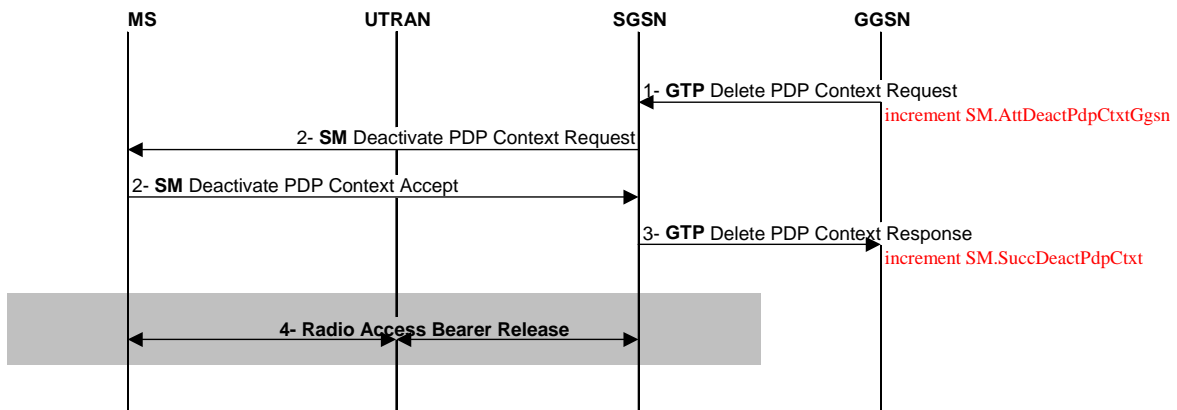

Figure: GGSN initiated PDP context deactivation

6.1.4.1 MS & SGSN-initiated session conclusions

6.1.4.1.1 Attempted MS & SGSN-initiated session conclusions

- a) This measurement provides the number of attempted PDP context deactivations initiated by MS & SGSN.
- b) CC.
- c) The measurement is incremented on receipt by the GGSN of a DELETE PDP CONTEXT REQUEST message. See TS 29.060.
- d) Integer.

- e) SM.AttDeactPdpCtxtMsAndSgsn.
- f) GgsnFunction.
- g) Valid for packet switched traffic.
- h) COMB.
- i) This measurement is mainly dedicated to Vendor Performance Modelling community.

#### 6.1.4.1.2 Successful MS & SGSN-initiated session conclusions

- a) This measurement provides the number of successful PDP context deactivations initiated by MS & SGSN.
- b) CC.
- c) The measurement is incremented on transmission by the GGSN of a DELETE PDP CONTEXT RESPONSE message with cause "Request Accepted". See TS 29.060.
- d) Integer.
- e) SM.SuccDeactPdpCtxtMsAndSgsn.
- f) GgsnFunction.
- g) Valid for packet switched traffic.
- h) COMB.
- i) This measurement is mainly dedicated to Vendor Performance Modelling community.

#### 6.1.4.2 GGSN-initiated session conclusions

##### 6.1.4.2.1 Attempted GGSN-initiated session conclusions

- a) This measurement provides the number of attempted PDP context deactivations initiated by GGSN.
- b) CC.
- c) The measurement is incremented on transmission by the GGSN of a DELETE PDP CONTEXT REQUEST message. See TS 29.060.
- d) Integer.
- e) SM.AttDeactPdpCtxtGgsn.
- f) GgsnFunction.
- g) Valid for packet switched traffic.
- h) COMB.
- i) This measurement is mainly dedicated to Vendor Performance Modelling community.

##### 6.1.4.2.2 Successful GGSN-initiated session conclusions

- a) This measurement provides the number of successful PDP context deactivations initiated by GGSN.
- b) CC.
- c) The measurement is incremented on receipt by the GGSN of a DELETE PDP CONTEXT RESPONSE message with cause "Request Accepted". See TS 29.060.
- d) Integer.
- e) SM.SuccDeactPdpCtxtGgsn.

- f) GgsnFunction.
- g) Valid for packet switched traffic.
- h) COMB.
- i) This measurement is mainly dedicated to Vendor Performance Modelling community.

## 6.2 Per APN measurements

These measurements will only be provided for a subset of all the APNs of the GGSN (see TS 23.003 for APN definition). The way the list of monitored APNs is configured is outside the scope of the present document.

### 6.2.1 Session establishments

The performance counters presented in this subclause are intended to bring a more detailed view on session activations compared to counters defined in subclause 1.1. Especially, they enable to monitor the session establishment success rate when user authentication is required and when a dynamic PDP address is to be allocated by the GGSN.

Furthermore, the definition of "per APN" measurements allows to let performance monitoring focus on a "specific service" handled by a GGSN: TS 23.003 indicates that an APN Network Identifier may be used to access a service associated with a GGSN and that this may be achieved by defining:

- an APN that corresponds to a DNS name of a GGSN and is locally interpreted by the GGSN as a request for a specific service; or
- an APN Network Identifier consisting of 3 or more labels and starting with a Reserved Service Label, or an APN Network Identifier consisting of a Reserved Service Label alone, that indicates a GGSN by the nature of the requested service.

The figure below, from TS 29.061 [26] details the message sequence during a PDP context activation for the non-transparent IP case, where a dynamic PDP address is to be allocated and user authentication is required.



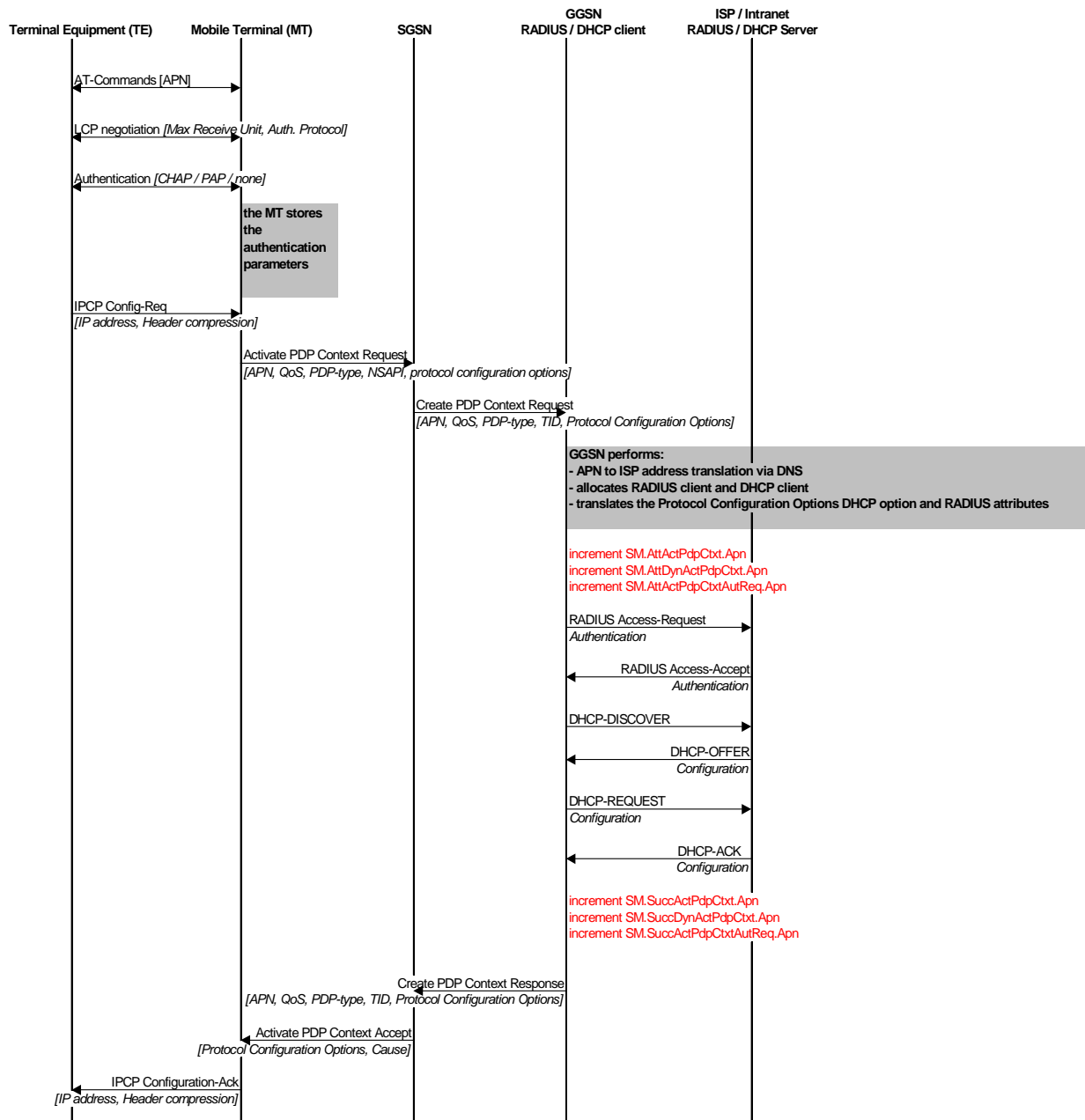

Figure

6.2.1.1 Session establishments, per APN

6.2.1.1.1 Attempted session establishments, per APN

- a) This measurement provides the number of PDP context activation procedures on a per APN of the GGSN basis.
- b) CC.
- c) The measurement is incremented on receipt by the GGSN of a CREATE PDP CONTEXT REQUEST message from the SGSN. See TS 29.060.
- d) Integer.
- e) SM.AttActPdpCtxt.Apn.
- f) GgsnFunction, per APN.
- g) Valid for packet switched traffic.

- h) COMB.
- i) This measurement is mainly dedicated to Operator Business and Vendor Performance Modelling communities.

#### 6.2.1.1.2 Successfully established sessions, per APN

- a) This measurement provides the number of successfully completed activation PDP context procedures on a per APN of the GGSN basis.
- b) CC.
- c) The measurement is incremented on transmission of a CREATE PDP CONTEXT RESPONSE message with cause "Request Accepted " from GGSN. See TS 29.060.
- d) Integer.
- e) SM.SuccActPdpCtxt.Apn.
- f) GgsnFunction, per APN.
- g) Valid for packet switched traffic.
- h) COMB.
- i) This measurement is mainly dedicated to Operator Business and Vendor Performance Modelling communities.

#### 6.2.1.2 Session establishments with dynamic PDP address allocation required, per APN

##### 6.2.1.2.1 Attempted session establishments with dynamic PDP address allocation required, per APN

- a) This measurement provides the number of dynamic PDP context activation procedures where a dynamic PDP address is requested on a per APN of the GGSN basis.
- b) CC.
- c) The measurement is incremented on receipt by the GGSN of a CREATE PDP CONTEXT REQUEST message with an empty PDP address, which indicates that the MS requires a dynamic PDP address. See TS 29.060.
- d) Integer.
- e) SM.AttDynActPdpCtxt.Apn.
- f) GgsnFunction, per APN.
- g) Valid for packet switched traffic.
- h) COMB.
- i) This measurement is mainly dedicated to Vendor Performance Modelling and Operator Maintenance communities.

##### 6.2.1.2.2 Successfully established sessions with dynamic PDP address allocation required, per APN

- a) This measurement provides the number of successfully attempted dynamic PDP context activation procedures where a dynamic PDP address is requested on a per APN of the GGSN basis.
- b) CC.
- c) The measurement is incremented on transmission by the GGSN of a CREATE PDP CONTEXT RESPONSE message with cause "Request Accepted" where the PDP address has been dynamically assigned. See TS 23.060 and TS 29.060.

- d) Integer.
- e) SM.SuccDynActPdpCtxt.Apn.
- f) GgsnFunction, per APN.
- g) Valid for packet switched traffic.
- h) COMB.
- i) This measurement is mainly dedicated to Vendor Performance Modelling and Operator Maintenance communities.

### 6.2.1.3 Session establishments with user authentication required, per APN

#### 6.2.1.3.1 Attempted session establishments with user authentication required, per APN

- a) This measurement provides the number of PDP context activation procedures for which user authentication is required.
- b) CC.
- c) The measurement is incremented when a CREATE PDP CONTEXT REQUEST message is received by the GGSN, for which protocol configuration options indicates that user authentication is required to access the external PDN. See TS 29.060 and TS 24.008.
- d) Integer.
- e) SM.AttActPdpCtxtAutReq.Apn.
- f) GgsnFunction, per APN.
- g) Valid for packet switched traffic.
- h) COMB.
- i) This measurement is mainly dedicated to Vendor Performance Modelling and Operator Maintenance communities.

#### 6.2.1.3.2 Failed session establishments due to user authentication failure, per APN

- a) This measurement provides the number of PDP context activation procedures failed due to user authentication failure.
- b) CC.
- c) The measurement is incremented when a CREATE PDP CONTEXT RESPONSE message with cause "User Authentication Failed" is received by the GGSN. See TS 29.060 and TS 24.008.
- d) Integer.
- e) SM.FailActPdpCtxtAutReq.Apn.
- f) GgsnFunction, per APN.
- g) Valid for packet switched traffic.
- h) COMB.
- i) This measurement is mainly dedicated to Vendor Performance Modelling and Operator Maintenance communities.

## 6.2.2 Active sessions

The performance counters presented in this subclause are defined on a per APN basis and are mainly intended:

- to monitor the repartition of QoS attributes defined for current active sessions; and
- to establish a session profile. A session profile details the number of elementary procedures per active session (PDP context modifications, updates, ...), usually during a busy hour.

### 6.2.2.1 Number of simultaneous active sessions, per APN

- a) This measurement provides the current number of simultaneous active sessions per APN. This measurement is split into subcounters per traffic class and allocation/retention priority (or precedence class) indicated in the QoS profile.
- b) GAUGE.
- c) The relevant measurement is incremented on transmission by the GGSN of a CREATE PDP CONTEXT RESPONSE message with cause "Request Accepted" according to the traffic class or allocation/retention priority indicated in the QoS profile.  
The relevant measurement is decremented on transmission or receipt of DELETE PDP CONTEXT RESPONSE with cause "Request Accepted" according to the traffic class or the allocation/retention priority of the PDP context.  
In case of a PDP context activated with R97/98 QoS attributes, the fields traffic class and allocation/retention priority used for screening are derived from delay class and precedence class respectively, as ruled in TS 23.107 [8].  
See also TS 24.008 and TS 29.060.
- d) A single integer value per measurement type defined in e).
- e) SM.NbrActPdpCtxt.Apn.Low  
SM.NbrActPdpCtxt.Apn.Medium  
SM.NbrActPdpCtxt.Apn.High  
SM.NbrActPdpCtxt.Apn.Conv  
SM.NbrActPdpCtxt.Apn.Strm  
SM.NbrActPdpCtxt.Apn.Intact  
SM.NbrActPdpCtxt.Apn.Bgrd.
- f) GgsnFunction, per APN.
- g) Valid for packet switched traffic.
- h) COMB.
- i) This measurement is mainly dedicated to Operator Business and Vendor Performance Modelling communities.

### 6.2.2.2 Peak number of simultaneous active sessions, per APN

- a) This measurement provides the peak number of active PDP contexts in GGSN per APN. This measurement is obtained by comparing following an update of the actual number of active PDP context in GGSN per APN, this value with the currently maximal value within the actual granularity period.
- b) GAUGE.
- c) The measurement is incremented on transmission by the GGSN of a CREATE PDP CONTEXT RESPONSE message with cause "Request Accepted" and decremented on transmission or receipt by the GGSN of a DELETE PDP CONTEXT RESPONSE message with cause "Request Accepted". The measurement value keeps track of the highest value experienced in the collection interval. See TS 29.060.
- d) Integer.
- e) SM.MaxNbrActPdpCtxt.Apn.
- f) GgsnFunction, per APN.

- g) Valid for packet switched traffic.
- h) COMB.
- i) This measurement is mainly dedicated to Operator Business and Vendor Performance Modelling communities.

### 6.2.2.3 MS & SGSN-initiated session modifications, per APN

#### 6.2.2.3.1 Attempted MS & SGSN-initiated session modifications, per APN

- a) This measurement provides the number of PDP context updates attempted, either by MS or SGSN.
- b) CC.
- c) The measurement is incremented on receipt by the GGSN of an UPDATE PDP CONTEXT REQUEST message. See TS 29.060.
- d) Integer.
- e) SM.AttUpdPdpCtxtMsAndSgsn.Apn.
- f) GgsnFunction, per APN.
- g) Valid for packet switched traffic.
- h) COMB.
- i) This measurement is mainly dedicated to Vendor Performance Modelling community.

#### 6.2.2.3.2 Successfully performed MS & SGSN-initiated session modifications, per APN

- a) This measurement provides the number of successfully performed PDP context updates initiated either by MS or SGSN.
- b) CC.
- c) The measurement is incremented on transmission by the GGSN of an UPDATE PDP CONTEXT RESPONSE message with cause "Request Accepted". See TS 29.060.
- d) Integer.
- e) SM.SuccUpdPdpCtxtMsAndSgsn.Apn.
- f) GgsnFunction, per APN.
- g) Valid for packet switched traffic.
- h) COMB.
- i) This measurement is mainly dedicated to Vendor Performance Modelling community.

## 6.2.3 Session conclusions

### 6.2.3.1 MS-initiated session conclusions, per APN

#### 6.2.3.1.1 Attempted MS-initiated session conclusions, per APN

- a) This measurement provides the number of PDP context deactivation procedures initiated by the MS on a per APN of the GGSN basis.
- b) CC.
- c) The measurement is incremented on receipt by the GGSN of a DELETE PDP CONTEXT REQUEST message from the SGSN. See TS 23.060 and TS 29.060.

- d) Integer.
- e) SM.AttDeactPdpCtxtMs.Apn.
- f) GgsnFunction, per APN.
- g) Valid for packet switched traffic.
- h) COMB.
- i) This measurement is mainly dedicated to Vendor Performance Modelling community.

#### 6.2.3.1.2 Successful MS-initiated session conclusions, per APN

- a) This measurement provides the number of successfully completed PDP context deactivation procedures initiated by the MS on a per APN of the GGSN basis.
- b) CC.
- c) The measurement is incremented on transmission by the GGSN of a DELETE PDP CONTEXT RESPONSE message with cause "Request Accepted" to the SGSN. See TS 29.060.
- d) Integer.
- e) SM.SuccDeactPdpCtxtMs.Apn.
- f) GgsnFunction, per APN.
- g) Valid for packet switched traffic.
- h) COMB.
- i) This measurement is mainly dedicated to Vendor Performance Modelling community.

#### 6.2.3.2 GGSN-initiated session conclusions, per APN

##### 6.2.3.2.1 Attempted GGSN-initiated session conclusions, per APN

- a) This measurement provides the number of PDP context deactivation procedures initiated by the GGSN, on a per APN of the GGSN basis.
- b) CC.
- c) The measurement is incremented on transmission by the GGSN of a DELETE PDP CONTEXT REQUEST message to the SGSN. See TS 29.60.
- d) Integer.
- e) SM.AttDeactPdpCtxtGgsn.Apn.
- f) GgsnFunction, per APN.
- g) Valid for packet switched traffic.
- h) COMB.
- i) This measurement is mainly dedicated to Vendor Performance Modelling community.

##### 6.2.3.2.2 Successful GGSN-initiated session conclusions, per APN

- a) This measurement provides the number of successfully completed PDP context deactivation procedures initiated by the GGSN, on a per APN of the GGSN basis.
- b) CC.

- c) The measurement is incremented on receipt of DELETE PDP CONTEXT RESPONSE message with cause "Request Accepted" from the SGSN.
- d) Integer.
- e) SM.SuccDeactPdpCtxtGgsn.Apn.
- f) GgsnFunction, per APN.
- g) Valid for packet switched traffic.
- h) COMB.
- i) This measurement is mainly dedicated to Vendor Performance Modelling community.

## 6.3 GTP measurements

The performance counters presented in this subclause are mainly intended to:

- monitor the signalling and bearer traffic exchanged between the GGSN and peer GSNs;
- establish the session profile (including GTP average packet size, signalling overhead, uplink and downlink GTP traffic per session, ...); and
- monitor the GGSN load (through measurements such as the total bit rate handled by the node, the number of GTP tunnels handled or the ratio of packets discarded at GGSN level).

These counters are associated to GPRS Tunnelling Protocol (GTP-C and GTP-U), between the SGSN and the GGSN, and defined in TS 23.060 and TS 29.060. The breakdown per traffic class allows to monitor the way traffic is handled by the GGSN according to QoS attributes attached to the relevant PDP context.

### 6.3.1 Number of incoming GTP data packets on the Gn interface

- a) This measurement provides the number of GTP Data Packets received on the Gn interface. This measurement is split into subcounters per traffic class.
- b) CC.
- c) The relevant measurement is incremented on receipt of a GTP data packet on the Gn interface, according to the traffic class of the related PDP context. In case of a PDP context activated with R97/98 QoS attributes, the field traffic class used for screening is derived from delay class, as ruled in TS 23.107 [8]. See also TS 29.060.
- d) A single integer value per measurement type defined in e).
- e) GTP.IncDataPkt.Bgrd  
GTP.IncDataPkt.Conv  
GTP.IncDataPkt.Intact  
GTP.IncDataPkt.Strm.
- f) GgsnFunction.
- g) Valid for packet switched traffic.
- h) COMB.
- i) This measurement is mainly dedicated to Vendor Performance Modelling, Operator Traffic Engineering and Vendor Development Engineering communities.

### 6.3.2 Number of outgoing GTP data packets on the Gn interface

- a) This measurement provides the number of GTP Data Packets sent onto the Gn interface. This measurement is split into subcounters per traffic class.
- b) CC.

- c) The relevant measurement is incremented on transmission of a GTP data packet on the Gn interface, according to the traffic class indicated in the QoS profile of the related PDP context. In case of a PDP context activated with R97/98 QoS attributes, the field traffic class used for screening is derived from delay class, as ruled in TS 23.107 [8]. See also TS 29.060.
- d) A single integer value per measurement type defined in e).
- e) GTP.OutDataPkt.Bgrd  
GTP.OutDataPkt.Conv  
GTP.OutDataPkt.Intact  
GTP.OutDataPkt.Strm.
- f) GgsnFunction.
- g) Valid for packet switched traffic.
- h) COMB.
- i) This measurement is mainly dedicated to Vendor Performance Modelling, Operator Traffic Engineering and Vendor Development Engineering communities.

### 6.3.3 Number of discarded GTP data packets

- a) This measurement provides the number of GTP Data Packets discarded. This measurement is split into subcounters per traffic class.
- b) CC.
- c) The relevant measurement is incremented when a GTP data packet is discarded, according to the traffic class indicated in the QoS profile of the related PDP context. In case of a PDP context activated with R97/98 QoS attributes, the field traffic class used for screening is derived from delay class, as ruled in TS 23.107 [8]. See also TS 29.060.
- d) A single integer value per measurement type defined in e).
- e) GTP.DiscDataPkt.Bgrd  
GTP.DiscDataPkt.Conv  
GTP.DiscDataPkt.Intact  
GTP.DiscDataPkt.Strm.
- f) GgsnFunction.
- g) Valid for packet switched traffic.
- h) COMB.
- i) This measurement is mainly dedicated to Vendor Performance Modelling, Operator Traffic Engineering and Vendor Development Engineering communities.

### 6.3.4 Number of octets of incoming GTP data packets on the Gn interface

- a) This measurement provides the number of GTP payload octets received. This measurement is split into subcounters per traffic class.
- b) CC.
- c) The relevant measurement is incremented on receipt of a GTP data packet on the Gn interface, according to the traffic class indicated in the QoS profile of the related PDP context. In case of a PDP context activated with R97/98 QoS attributes, the field traffic class used for screening is derived from delay class, as ruled in TS 23.107 [8]. The data packet size is extracted from the GTP header and added on to the measurement value. See TS 29.060.
- d) A single integer value per measurement type defined in e).



- e) GTP.IncDataOct.Bgrd  
GTP.IncDataOct.Conv  
GTP.IncDataOct.Intact  
GTP.IncDataOct.Strm.
- f) GgsnFunction.
- g) Valid for packet switched traffic.
- h) COMB.
- i) This measurement is mainly dedicated to Vendor Performance Modelling and Operator Traffic Engineering communities.

### 6.3.5 Number of octets of outgoing GTP data packets on the Gn interface

- a) This measurement provides the number of GTP payload octets sent. This measurement is split into subcounters per traffic class.
- b) CC.
- c) The relevant measurement is incremented on transmission of a GTP data packet on the Gn interface, according to the traffic class indicated in the QoS profile of the related PDP context. In case of a PDP context activated with R97/98 QoS attributes, the field traffic class used for screening is derived from delay class, as ruled in TS 23.107 [8]. The data packet size is extracted from the GTP header and added on to the measurement value. See TS 29.060.
- d) A single integer value per measurement type defined in e).
- e) GTP.OutDataOct.Bgrd  
GTP.OutDataOct.Conv  
GTP.OutDataOct.Intact  
GTP.OutDataOct.Strm.
- f) GgsnFunction.
- g) Valid for packet switched traffic.
- h) COMB.
- i) This measurement is mainly dedicated to Vendor Performance Modelling and Operator Traffic Engineering communities.

### 6.3.6 Number of incoming GTP signalling packets on the Gn interface

- a) This measurement provides the number of GTP signalling packets received on the Gn interface. This measurement is split into subcounters per traffic class.
- b) CC.
- c) The relevant measurement is incremented on receipt of a GTP signalling packet on the Gn interface, according to the traffic class of the related PDP context. In case of a PDP context activated with R97/98 QoS attributes, the field traffic class used for screening is derived from delay class, as ruled in TS 23.107 [8]. See also TS 29.060.
- d) A single integer value per measurement type defined in e).
- e) GTP.IncSigPkt.Bgrd  
GTP.IncSigPkt.Conv  
GTP.IncSigPkt.Intact  
GTP.IncSigPkt.Strm.
- f) GgsnFunction.
- g) Valid for packet switched traffic.

- h) COMB.
- i) This measurement is mainly dedicated to Vendor Performance Modelling, Operator Traffic Engineering and Vendor Development Engineering communities.

### 6.3.7 Number of outgoing GTP signalling packets on the Gn interface

- a) This measurement provides the number of GTP signalling packets sent onto the Gn interface. This measurement is split into subcounters per traffic class.
- b) CC.
- c) The relevant measurement is incremented on transmission of a GTP signalling packet on the Gn interface, according to the traffic class indicated in the QoS profile of the related PDP context. In case of a PDP context activated with R97/98 QoS attributes, the field traffic class used for screening is derived from delay class, as ruled in TS 23.107 [8]. See also TS 29.060.
- d) A single integer value per measurement type defined in e).
- e) GTP.OutSigPkt.Bgrd  
GTP.OutSigPkt.Conv  
GTP.OutSigPkt.Intact  
GTP.OutSigPkt.Strm.
- f) GgsnFunction.
- g) Valid for packet switched traffic.
- h) COMB.
- i) This measurement is mainly dedicated to Vendor Performance Modelling, Operator Traffic Engineering and Vendor Development Engineering communities.

### 6.3.8 Number of discarded GTP signalling packets

- a) This measurement provides the number of GTP signalling packets discarded. This measurement is split into subcounters per traffic class.
- b) CC.
- c) The relevant measurement is incremented when a GTP signalling packet is discarded, according to the traffic class indicated in the QoS profile of the related PDP context. In case of a PDP context activated with R97/98 QoS attributes, the field traffic class used for screening is derived from delay class, as ruled in TS 23.107 [8]. See also TS 29.060.
- d) A single integer value per measurement type defined in e).
- e) GTP.DiscSigPkt.Bgrd  
GTP.DiscSigPkt.Conv  
GTP.DiscSigPkt.Intact  
GTP.DiscSigPkt.Strm.
- f) GgsnFunction.
- g) Valid for packet switched traffic.
- h) COMB.
- i) This measurement is mainly dedicated to Vendor Performance Modelling, Operator Traffic Engineering and Vendor Development Engineering communities.

### 6.3.9 Number of octets of incoming GTP signalling packets on the Gn interface

- a) This measurement provides the number of octets of received GTP signalling packets. This measurement is split into subcounters per traffic class.
- b) CC.
- c) The relevant measurement is incremented on receipt of a GTP signalling packet on the Gn interface, according to the traffic class indicated in the QoS profile of the related PDP context. In case of a PDP context activated with R97/98 QoS attributes, the field traffic class used for screening is derived from delay class, as ruled in TS 23.107 [8]. The signalling packet size is extracted from the GTP header and added on to the measurement value. See TS 29.060.
- d) A single integer value per measurement type defined in e).
- e) GTP.IncSigOct.Bgrd  
GTP.IncSigOct.Conv  
GTP.IncSigOct.Intact  
GTP.IncSigOct.Strm.
- f) GgsnFunction.
- g) Valid for packet switched traffic.
- h) COMB.
- i) This measurement is mainly dedicated to Vendor Performance Modelling and Operator Traffic Engineering communities.

### 6.3.10 Number of octets of outgoing GTP signalling packets on the Gn interface

- a) This measurement provides the number of octets of sent GTP signalling packets. This measurement is split into subcounters per traffic class.
- b) CC.
- c) The relevant measurement is incremented on transmission of a GTP signalling packet on the Gn interface, according to the traffic class indicated in the QoS profile of the related PDP context. In case of a PDP context activated with R97/98 QoS attributes, the field traffic class used for screening is derived from delay class, as ruled in TS 23.107 [8]. The signalling packet size is extracted from the GTP header and added on to the measurement value. See TS 29.060.
- d) A single integer value per measurement type defined in e).
- e) GTP.OutSigOct.Bgrd  
GTP.OutSigOct.Conv  
GTP.OutSigOct.Intact  
GTP.OutSigOct.Strm.
- f) GgsnFunction.
- g) Valid for packet switched traffic.
- h) COMB.
- i) This measurement is mainly dedicated to Vendor Performance Modelling and Operator Traffic Engineering communities.

### 6.3.11 Number of GTP tunnels on the Gn interface

- a) This measurement provides the current number of simultaneous GTP tunnels on Gn interface handled by the GGSN.
- b) GAUGE.
- c) The measurement is incremented on transmission by the GGSN of a CREATE PDP CONTEXT RESPONSE message with cause "Request Accepted".  
It is decremented on transmission by the GGSN of a DELETE PDP CONTEXT RESPONSE message with cause "Request Accepted".  
The measurement includes GTP tunnels for data (user plane) as well as GTP tunnels for signalling (control plane). See TS 29.060.
- d) Integer.
- e) GTP.NbrTunnels.
- f) GgsnFunction.
- g) Valid for packet switched traffic.
- h) COMB.
- i) This measurement is mainly dedicated to Vendor Performance Modelling and Operator Traffic Engineering communities.

### 6.3.12 Number of GTP tunnels created on the Gn interface

- a) This measurement provides the number of GTP Tunnels created on Gn interface.
- b) CC.
- c) The measurement is incremented on transmission by the GGSN of a CREATE PDP CONTEXT RESPONSE message with cause "Request Accepted".  
The measurement includes GTP tunnels for data (user plane) as well as GTP tunnels for signalling (control plane). See TS 29.060.
- d) Integer.
- e) GTP.NbrCreatTunnels.
- f) GgsnFunction.
- g) Valid for packet switched traffic.
- h) COMB.
- i) This measurement is mainly dedicated to Vendor Performance Modelling and Operator Traffic Engineering communities.

## 6.4 GTP' measurements

The performance counters presented in this subclause are intended to monitor the transfer of G-CDRs to the CGF; in particular

- The number of CDR transfer attempts, together with the cause triggering the transfer enables to dimension both the CGF / Billing System and the Ga interface. The breakdown of causes for transfer attempts may also help in tuning the parameters associated to partial CDR creation.
- The breakdown of causes for transfer failure is provided to track and investigate any problem that could be detected thanks to the CDR transfer success rate.

These counters are associated to the GTP' protocol between the GGSN and the CGF, as defined in TS 29.060 and TS 32.015.

The figure below from TS 32.015 shows a normal CDR transfer between a GGSN and a CGF and details the events triggering the update of the counters values.

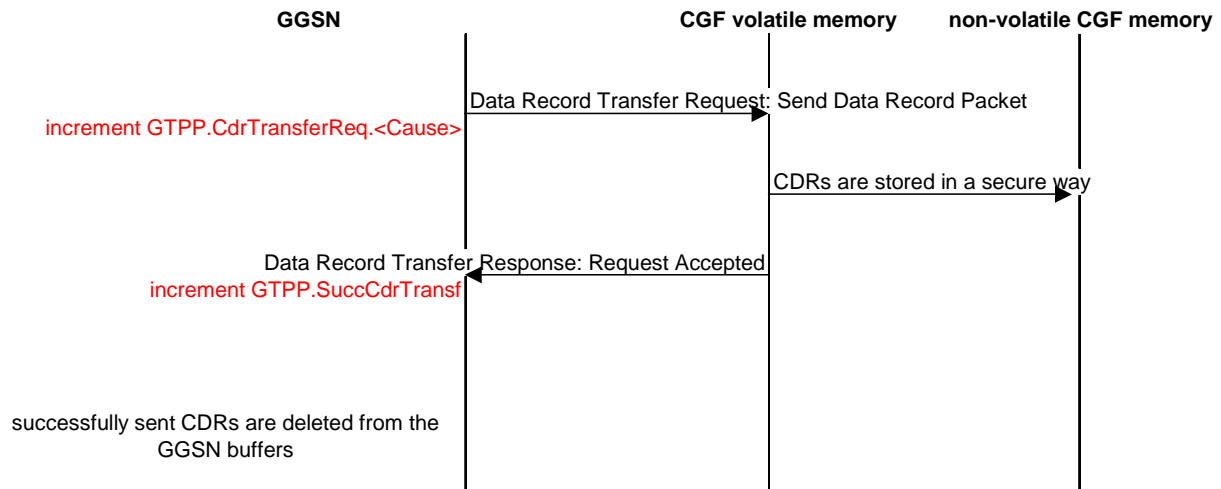

Figure from TS 32.015

The three measurement types defined in the clause 6.4 are subject to the "2 out of 3 approach".

### 6.4.1 Attempted CDR information transfers

- This measurement provides the number of CDR information transfers attempted. This measurement is split into subcounters per transfer triggering cause.
- CC.
- The relevant measurement is incremented when a DATA RECORD TRANSFER REQUEST message used to transmit CDR information is sent to the CGF, according to the cause that triggered the transfer. Possible causes are included in TS 32.015.
- Each measurement is an integer value.
- The measurement name has the form GTPP.CdrTransfReq.Cause where Cause indicates the cause that triggered the transfer.
- GgsnFunction.
- Valid for packet switched traffic.
- COMB.
- This measurement is mainly dedicated to Vendor Performance Modelling and Operator Traffic Engineering communities.

### 6.4.2 Successful CDR information transfers

- This measurement provides the number of CDR information successfully transmitted to CGF.
- CC.
- The measurement is incremented on receipt by the GGSN of a DATA RECORD TRANSFER RESPONSE message with cause code "Request Accepted".
- Integer.
- GTPP.SuccCdrTransf.

- f) GgsnFunction.
- g) Valid for packet switched traffic.
- h) COMB.
- i) This measurement is mainly dedicated to Vendor Performance Modelling and Operator Traffic Engineering communities.

### 6.4.3 Failed CDR information transfers

- a) This measurement provides the number of CDR information failed to be transferred to CGF. This measurement is split into subcounters per failure cause. Possible causes are included in TS 32.015.
- b) CC.
- c) The relevant measurement is incremented on receipt by the GGSN of a DATA RECORD TRANSFER RESPONSE message according to the failure cause.
- d) Each measurement is an integer value.
- e) The measurement name has the form GTPP.FailCdrTransf.Cause where Cause indicates the failure cause.
- f) GgsnFunction.
- g) Valid for packet switched traffic.
- h) COMB.
- i) This measurement is mainly dedicated to Vendor Performance Modelling, Operator Maintenance and Operator Traffic Engineering communities.

## 6.5 IP measurements

The performance counters presented in this subclause are mainly intended to:

- monitor the bearer traffic exchanged between the GGSN and the external PDN on the Gi interface;
- establish the session profile (including IP average packet size, uplink and downlink IP traffic per session, ...), possibly per traffic class; and
- monitor the GGSN load (through measurements such as the total bit rate handled by the node, the ratio of packets discarded at GGSN level, ...).

These counters are associated to IP protocol on the Gi interface.

These counters are proposed to be screened with regards to the protocol configuration options, as defined in TS 24.008 and TS 29.061, i.e. a set of the counters is associated to any valid combination of the different options below:

- transparent or non-transparent access to the external PDN;
- user data encryption (IPSec, ...);
- tunnelling of packets onto the Gi interface.

Any valid combination of these options fully defines a "Gi reference point". The figure below gives an overview of some Gi reference points.

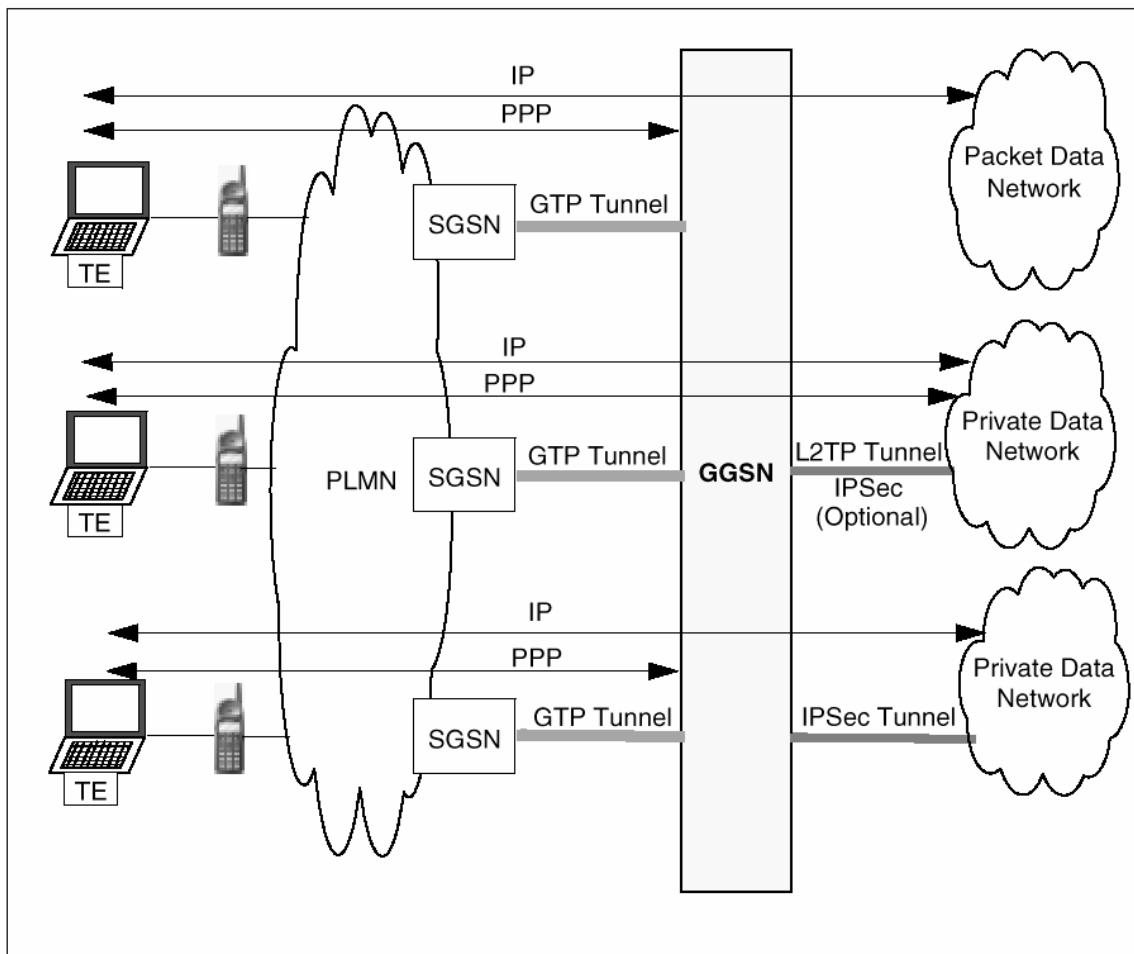

Figure: Overview of some Gi reference points

### 6.5.1 Number of incoming IP data packets on the Gi interface

This measurement provides the number of IP data packets received on the Gi interface. This measurement is split into subcounters per traffic class of the related PDP context.

- a) CC.
- b) The relevant measurement is incremented on receipt of an IP data packet on the Gi interface, according to the traffic class of the related PDP context. In case of a PDP context activated with R97/98 QoS attributes, the field traffic class used for screening is derived from delay class, as ruled in TS 23.107 [8]. See also 07 and TS 29.061 [26].
- c) A single integer value per measurement type defined in e).
- d) IP.IncDataPkt.Bgrd  
IP.IncDataPkt.Conv  
IP.IncDataPkt.Intact  
IP.IncDataPkt.Strm.
- e) GgsnFunction, per Gi reference point.
- f) Valid for packet switched traffic.
- g) COMB.
- h) This measurement is mainly dedicated to Vendor Performance Modelling, Operator Traffic Engineering and Vendor Development Engineering communities.

## 6.5.2 Number of outgoing IP data packets on the Gi interface

- a) This measurement provides the number of IP data packets sent onto the Gi interface. This measurement is split into subcounters per traffic class of the related PDP context.
- b) CC.
- c) The relevant measurement is incremented on transmission of an IP data packet on the Gi interface, according to the traffic class of the related PDP context. In case of a PDP context activated with R97/98 QoS attributes, the field traffic class used for screening is derived from delay class, as ruled in TS 23.107 [8]. See also TS 29.061 [26].
- d) A single integer value per measurement type defined in e).
- e) IP.OutDataPkt.Bgrd  
IP.OutDataPkt.Conv  
IP.OutDataPkt.Intact  
IP.OutDataPkt.Strm.
- f) GgsnFunction, per Gi reference point.
- g) Valid for packet switched traffic.
- h) COMB.
- i) This measurement is mainly dedicated to Vendor Performance Modelling, Operator Traffic Engineering and Vendor Development Engineering communities.

## 6.5.3 Number of IP data packets discarded due to node congestion

- a) This measurement provides the number of IP data packets discarded. This measurement is split into subcounters per traffic class of the related PDP context.
- b) CC.
- c) The relevant measurement is incremented when a received IP data packet is discarded due to node congestion, according to the traffic class of the related PDP context. In case of a PDP context activated with R97/98 QoS attributes, the field traffic class used for screening is derived from delay class, as ruled in TS 23.107 [8]. See also TS 29.061 [26].
- d) A single integer value per measurement type defined in e).
- e) IP.DiscDataPkt.Bgrd  
IP.DiscDataPkt.Conv  
IP.DiscDataPkt.Intact  
IP.DiscDataPkt.Strm.
- f) GgsnFunction, per Gi reference point.
- g) Valid for packet switched traffic.
- h) COMB.
- i) This measurement is mainly dedicated to Vendor Performance Modelling, Operator Traffic Engineering and Vendor Development Engineering communities.

## 6.5.4 Number of octets of incoming IP data packets on the Gi interface

- a) This measurement provides the number of IP payload octets received on the Gi interface. This measurement is split into subcounters per traffic class of the related PDP context.
- b) CC.



- c) The relevant measurement is incremented on receipt of an IP data packet on the Gi interface, according to the traffic class of the related PDP context. In case of a PDP context activated with R97/98 QoS attributes, the field traffic class used for screening is derived from delay class, as ruled in TS 23.107 [8]. The data packet size is extracted from the IP header and added on to the measurement value. See TS 29.061 [26].
- d) A single integer value per measurement type defined in e).
- e) IP.IncDataOct.Bgrd  
IP.IncDataOct.Conv  
IP.IncDataOct.Intact  
IP.IncDataOct.Strm.
- f) GgsnFunction, per Gi reference point.
- g) Valid for packet switched traffic.
- h) COMB.
- i) This measurement is mainly dedicated to Vendor Performance Modelling and Operator Traffic Engineering communities.

### 6.5.5 Number of octets of outgoing IP data packets on the Gi interface

- a) This measurement provides the number of IP payload octets sent onto the Gi interface. This measurement is split into subcounters per traffic class of the related PDP context.
- b) CC.
- c) The relevant measurement is incremented on transmission of an IP data packet on the Gi interface, according to the traffic class of the related PDP context. In case of a PDP context activated with R97/98 QoS attributes, the field traffic class used for screening is derived from delay class, as ruled in TS 23.107 [8]. The data packet size is extracted from the IP header and added on to the measurement value. See TS 29.061 [26].
- d) A single integer value per measurement type defined in e).
- e) IP.OutDataOct.Bgrd  
IP.OutDataOct.Conv  
IP.OutDataOct.Intact  
IP.OutDataOct.Strm.
- f) GgsnFunction, per Gi reference point.
- g) Valid for packet switched traffic.
- h) COMB.
- i) This measurement is mainly dedicated to Vendor Performance Modelling and Operator Traffic Engineering communities.

## 7 Measurements related to the MMS Relay/Server

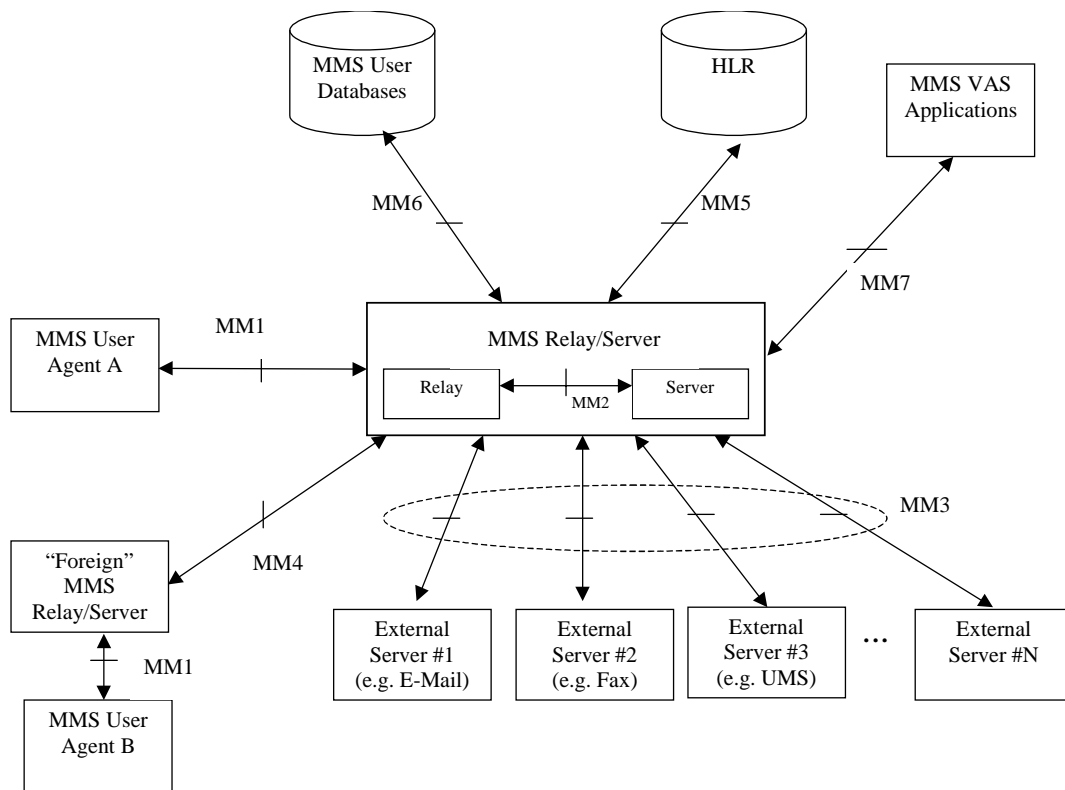

**Figure 7.1**

- MM1:** Reference point MM1 is used to submit Multimedia Messages from MMS User Agent to MMS Relay/Server, to let the MMS User Agent pull MMs from the MMS Relay/Server, let the MMS Relay/Server push information about MMs to the MMS User Agent as part of an MM notification, and to exchange delivery reports between MMS Relay/Server and MMS User Agents.
- MM2:** Not specified yet
- MM3:** Reference point MM3 is used by the MMS Relay/Server to send Multimedia Messages to and retrieve MMs from servers of external (legacy) messaging systems that are connected to the service provider's MMS Relay/Server.
- MM4:** Reference point MM4 between MMS Relay/Servers belonging to different MMSEs is used to transfer messages between them.
- MM5:** Reference point MM5 may be used to provide information to the MMS Relay/Server about the subscriber.
- MM6:** Not specified
- MM7:** Reference point MM7 is used to transfer MMs from MMS Relay/Server to MMS VAS applications and to transfer MMs from MMS VAS applications to MMS Relay/Server.

MMS uses a number of technologies to realise the requirements of the stage 1 description (TS 22.140) [1]. As far as possible existing protocols (e.g. WAP, SMTP, ESMTP as transfer protocols; lower layers to provide push, pull, notification) and existing message formats (e.g. SMIL, MIME) shall be used for the realisation of the Multimedia Messaging Service.

In order to define generic measurements, 3GPP should specify Performance measurements based on the Reference Points (MM1 to MM7) and not specific to the protocol implemented. So whatever the implementation IP or WAP for example, the Reference Point messages are generic and so the measurements will be the same.

The main interfaces involve in the MMS delivery are the interface MM1 and MM4, we can see in this diagram the exact messages involve in the delivery. Those messages can be used to define Performance Measurement on a MMS Relay/Server basis.

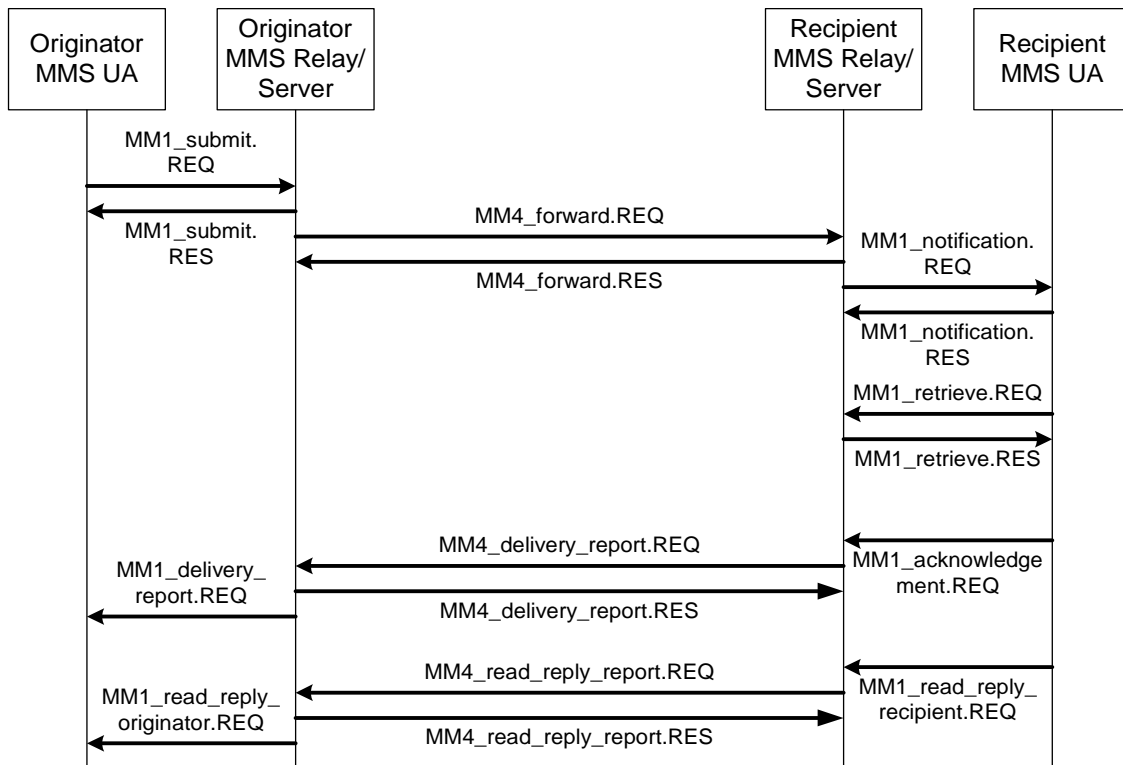

Figure 7.2: Example Abstract Message Flow

The most important quality metrics for MMS are availability, accuracy and speed. This contribution addresses the first two, the speed will require additional measurements based on time to deliver the multimedia messages. Availability and accuracy are a measure of the percentage of request that are successfully served and how complete the response is. The mentioned triggering points enable to define raw number of messages sent and received by the MMS Relay/Server, but is not good enough to gather service quality measurement, because those are only volume measurements. Also Response messages provide an acknowledgement mechanism for the request messages and those response messages can be positive or negative acknowledgement. This information is in the "Request Status" which is contained by the "Request Status" field in the response messages. So in order to gather service quality measurements, a higher granularity is required for the response messages measurements: subcounters per request status code are introduced for that purpose. This is for MM1 submission and retrieval as well as every MM4 response messages measurements.

Background Information on the Request Status from TS 23.140 [25].

**Request Status:** The originator MMS Relay/Server shall indicate the status of the MM1\_submit.REQ in the associated MM1\_submit.RES. The reason code given in the status information element of the MM1\_submit.RES may be supported with an explanatory text further qualifying the status. If this text is available in the Request status text information element the MMS User Agent should bring it to the user's attention. The choice of the language used in the Request status text information element is at the discretion of the MMS service provider.

**Table 7.1: Information elements in the MM1\_submit.RES**

Information element	Presence	Description
Message Type	Mandatory	Identifies this message as MM1_submit.RES.
Transaction ID	Mandatory	The identification of the MM1_submit.REQ/MM1_submit.RES pair.
MMS Version	Mandatory	Identifies the version of the interface supported by the MMS Relay/Server.
Request Status	Mandatory	The status of the MM submit request.
Request Status Text	Optional	Description which qualifies the status of the MM submit request.
Message ID	Conditional	The identification of the MM if it is accepted by the originator MMS Relay/Server.
Store Status	Conditional	If the Store request was present in MM1_submit.REQ, the status of the store request.
Store Status Text	Optional	The explanatory text corresponding to the Store Status, if present.
Stored Message Reference	Conditional	If the Store request was present in MM1_submit.REQ, the message reference to the newly stored MM.

**Table 7.2: Example of Request Status Code from TS 23.140 [25]**

Request-Status-Code	Meaning
Ok	The corresponding request and some or all of its contents were accepted without errors.
Error-unspecified	An unspecified error occurred during the processing or reception of the corresponding request.
Error-service-denied	The corresponding request was rejected due to failure of authentication or authorisation of the originating MMS Relay/Server.
Error-message-format-corrupt	An inconsistency with the message format was detected when the corresponding request was parsed.
Error-sending-address-unresolved	There were no MMS address (From:, To:, Cc:, Bcc:) in its proper format or none of the addresses belong to the recipient MMS Relay/Server.
Error-message-not-found	This status code is obsolete
Error-network-problem	The recipient MMS Relay/Server was not able to accept the corresponding request due to capacity overload.
Error-content-not-accepted	The MM content was not accepted due to size, media type, copyrights or some other reason.
Error-unsupported-message	The recipient MMS Relay/Server does not support the corresponding request abstract message.

## 7.1 MM1

MM1 is the interface between the MMS Relay/Server and the MMS User Agent, following are the proposed measurements.

### 7.1.1 Number of Multimedia Messages submit requests received by MMS Relay/Server

- a) This measurement provides the number of Multimedia Messages (MM) submit requests received by MMS Relay/Server from MMS User Agent on the Reference point MM1.
- b) CC.
- c) On receipt of a " MM1\_submit.REQ " message from MMS User Agent (TS 23.140 [25]).
- d) A single integer value.
- e) The measurement name has the form MMS.MM1SubReq.
- f) MMS Relay/Server Function.
- g) Valid for packet switching.
- h) GSM/UMTS.

### 7.1.2 Number of Multimedia Messages submit responses sent by MMS Relay/Server

- a) This measurement provides the number of Multimedia Messages (MM) submit responses sent by MMS Relay/Server to MMS User Agent on the Reference point MM1. The measurement is split into subcounters per request status code.
- b) CC.
- c) On transmission of a " MM1\_submit.RES " message to MMS User Agent. Each submit responses is added to the relevant measurement according to the request status code. See TS 23.140 [25].
- d) A single integer value.
- e) The measurement name has the form MMS.MM1SubRes.Status
- f) where Status identifies the request status code.
- g) MMS Relay/Server Function.
- h) Valid for packet switching.
- i) GSM/UMTS.

### 7.1.3 Number of Multimedia Messages notification requests sent by MMS Relay/Server

- a) This measurement provides the number of Multimedia Messages (MM) notification requests sent by MMS Relay/Server to MMS User Agent on the Reference point MM1.
- b) CC.
- c) On transmission of a " MM1\_notification.REQ " message to MMS User Agent (TS 23.140 [25]).
- d) A single integer value.
- e) The measurement name has the form MMS.MM1NotReq.
- f) MMS Relay/Server Function.
- g) Valid for packet switching.
- h) GSM/UMTS.

### 7.1.4 Number of Multimedia Messages notification responses received by MMS Relay/Server

- a) This measurement provides the number of Multimedia Messages (MM) notification responses received by MMS Relay/Server from MMS User Agent on the Reference point MM1.
- b) CC.
- c) On receipt of a " MM1\_notification.RES " message from MMS User Agent (TS 23.140 [25]).
- d) A single integer value.
- e) The measurement name has the form MMS.MM1NotRes.
- f) MMS Relay/Server Function.
- g) Valid for packet switching.
- h) GSM/UMTS.

### 7.1.5 Number of Multimedia Messages retrieve requests received by MMS Relay/Server

- a) This measurement provides the number of Multimedia Messages (MM) retrieve requests received by MMS Relay/Server from MMS User Agent on the Reference point MM1.
- b) CC.
- c) On receipt of a "MM1\_retrieve.REQ" message from MMS User Agent (TS 23.140 [25]).
- d) A single integer value.
- e) The measurement name has the form MMS.MM1RetReq.
- f) MMS Relay/Server Function.
- g) Valid for packet switching.
- h) GSM/UMTS.

### 7.1.6 Number of Multimedia Messages retrieve responses sent by MMS Relay/Server

- a) This measurement provides the number of Multimedia Messages (MM) retrieve responses sent by MMS Relay/Server to MMS User Agent on the Reference point MM1. The measurement is split into subcounters per request status code.
- b) CC.
- c) On transmission of a "MM1\_retrieve.RES " message to MMS User Agent. Each retrieve responses is added to the relevant measurement according to the request status code. See TS 23.140 [25].
- d) A single integer value.
- e) The measurement name has the form MMS.MM1RetRes.Status.
- f) where Status identifies the request status code.
- g) MMS Relay/Server Function.
- h) Valid for packet switching.
- i) GSM/UMTS.

### 7.1.7 Number of Multimedia Messages acknowledgement requests received by MMS Relay/Server

- a) This measurement provides the number of Multimedia Messages (MM) acknowledgement requests received by MMS Relay/Server from MMS User Agent on the Reference point MM1.
- b) CC.
- c) On receipt of a "MM1\_acknowledgement.REQ" message from MMS User Agent (TS 23.140 [25]).
- d) A single integer value.
- e) The measurement name has the form MMS.MM1AckReq.
- f) MMS Relay/Server Function.
- g) Valid for packet switching.
- h) GSM/UMTS.

### 7.1.8 Number of Multimedia Messages forward requests received by MMS Relay/Server

- a) This measurement provides the number of Multimedia Messages (MM) forward requests received by MMS Relay/Server from MMS User Agent on the Reference point MM1.
- b) CC.
- c) On receipt of a "MM1\_forward.REQ" message from MMS User Agent (TS 23.140 [25]).
- d) A single integer value.
- e) The measurement name has the form MMS.MM1fwdREQ.
- f) MMS Relay/Server Function.
- g) Valid for packet switching.
- h) GSM/UMTS.

### 7.1.9 Number of Multimedia Messages forward responses sent by MMS Relay/Server

- a) This measurement provides the number of Multimedia Messages (MM) forward responses sent by MMS Relay/Server to MMS User Agent on the Reference point MM1.
- b) CC.
- c) On transmission of a "MM1\_forward.RES" message to MMS User Agent (TS 23.140 [25]).
- d) A single integer value.
- e) The measurement name has the form MMS.MM1FwdRes.
- f) MMS Relay/Server Function.
- g) Valid for packet switching.
- h) GSM/UMTS.

### 7.1.10 Number of Multimedia Messages delivery report requests sent by MMS Relay/Server

- a) This measurement provides the number of Multimedia Messages (MM) delivery report requests sent by MMS Relay/Server to MMS User Agent on the Reference point MM1.
- b) CC.
- c) On transmission of a "MM1\_delivery\_report.REQ" message to MMS User Agent (TS 23.140 [25]).
- d) A single integer value.
- e) The measurement name has the form MMS.MM1RepReq.
- f) MMS Relay/Server Function.
- g) Valid for packet switching.
- h) GSM/UMTS.

### 7.1.11 Number of Multimedia Messages read reply recipient requests received by MMS Relay/Server

- a) This measurement provides the number of Multimedia Messages (MM) read reply recipient requests received by MMS Relay/Server to MMS User Agent on the Reference point MM1.
- b) CC.
- c) On receipt of a "MM1\_read\_reply\_recipient.REQ" message from MMS User Agent (TS 23.140 [25]).
- d) A single integer value.
- e) The measurement name has the form MMS.MM1ReadRecReq.
- f) MMS Relay/Server Function.
- g) Valid for packet switching.
- h) GSM/UMTS.

### 7.1.12 Number of Multimedia Messages read reply originator requests sent by MMS Relay/Server

- a) This measurement provides the number of Multimedia Messages (MM) read reply originator requests sent by MMS Relay/Server to MMS User Agent on the Reference point MM1.
- b) CC.
- c) On transmission of a "MM1\_read\_reply\_originator.REQ" message to MMS User Agent (TS 23.140 [25]).
- d) A single integer value.
- e) The measurement name has the form MMS.MM1ReadOrigReq.
- f) MMS Relay/Server Function.
- g) Valid for packet switching.
- h) GSM/UMTS.

## 7.2 MM4

MM4 is the interface between MMS Relay/Servers, following are the proposed measurements.

### 7.2.1 Number of Multimedia Messages forward requests received by MMS Relay/Server

- a) This measurement provides the number of Multimedia Messages (MM) forward requests received by MMS Relay/Server from another MMS Relay/Server on the Reference point MM4.
- b) CC.
- c) On receipt of a "MM4\_forward.REQ" message from MMS Relay/Server (TS 23.140 [25]).
- d) A single integer value.
- e) The measurement name has the form MMS.MM4FwdReqRec.
- f) MMS Relay/Server Function.
- g) Valid for packet switching.
- h) GSM/UMTS.



### 7.2.2 Number of Multimedia Messages forward requests sent by MMS Relay/Server

- a) This measurement provides the number of Multimedia Messages (MM) forward requests sent by MMS Relay/Server from another MMS Relay/Server on the Reference point MM4.
- b) CC.
- c) On transmission of a "MM4\_forward.REQ" message to MMS Relay/Server (TS 23.140 [25]).
- d) A single integer value.
- e) The measurement name has the form MMS.MM4FwdReqSnt.
- f) MMS Relay/Server Function.
- g) Valid for packet switching.
- h) GSM/UMTS.

### 7.2.3 Number of Multimedia Messages forward responses received by MMS Relay/Server

- a) This measurement provides the number of Multimedia Messages (MM) forward responses received by MMS Relay/Server from another MMS Relay/Server on the Reference point MM4. The measurement is split into subcounters per request status code.
- b) CC.
- c) On receipt of a "MM4\_forward.RES" message from MMS Relay/Server. Each forward responses is added to the relevant measurement according to the request status code. See TS 23.140 [25].
- d) A single integer value.
- e) The measurement name has the form MMS.MM4FwdResRec Status.
- f) where Status identifies the request status code.
- g) MMS Relay/Server Function.
- h) Valid for packet switching.
- i) GSM/UMTS.

### 7.2.4 Number of Multimedia Messages forward responses sent by MMS Relay/Server

- a) This measurement provides the number of Multimedia Messages (MM) forward responses sent by MMS Relay/Server from another MMS Relay/Server on the Reference point MM4. The measurement is split into subcounters per request status code.
- b) CC.
- c) On transmission of a " MM4\_forward.RES " message to MMS Relay/Server. Each forward response is added to the relevant measurement according to the request status code. See TS 23.140 [25].
- d) A single integer value.
- e) The measurement name has the form MMS.MM4FwdResSnt Status.
- f) where Status identifies the request status code.
- g) MMS Relay/Server Function.

- h) Valid for packet switching.
- i) GSM/UMTS.

### 7.2.5 Number of Multimedia Messages delivery report requests received by MMS Relay/Server

- a) This measurement provides the number of Multimedia Messages (MM) delivery report requests received by MMS Relay/Server from another MMS Relay/Server on the Reference point MM4.
- b) CC.
- c) On receipt of a "MM4\_delivery\_report.REQ" message from MMS Relay/Server (TS 23.140 [25]).
- d) A single integer value.
- e) The measurement name has the form MMS.MM4RepReqRec.
- f) MMS Relay/Server Function.
- g) Valid for packet switching.
- h) GSM/UMTS.

### 7.2.6 Number of Multimedia Messages delivery report requests sent by MMS Relay/Server

- a) This measurement provides the number of Multimedia Messages (MM) delivery report requests sent by MMS Relay/Server from another MMS Relay/Server on the Reference point MM4.
- b) CC.
- c) On transmission of a "MM4\_delivery\_report.REQ" message to MMS Relay/Server (TS 23.140 [25]).
- d) A single integer value.
- e) The measurement name has the form MMS.MM4RepReqSnt.
- f) MMS Relay/Server Function.
- g) Valid for packet switching.
- h) GSM/UMTS.

### 7.2.7 Number of Multimedia Messages delivery report responses received by MMS Relay/Server

- a) This measurement provides the number of Multimedia Messages (MM) delivery report responses received by MMS Relay/Server from another MMS Relay/Server on the Reference point MM4. The measurement is split into subcounters per request status code.
- b) CC.
- c) On receipt of a "MM4\_delivery\_report.RES" message from MMS Relay/Server. Each delivery report responses is added to the relevant measurement according to the request status code. See TS 23.140 [25].
- d) A single integer value.
- e) The measurement name has the form MMS.MM4RepResRec Status.
- f) where Status identifies the request status code.
- g) MMS Relay/Server Function.

- h) Valid for packet switching.
- i) GSM/UMTS.

### 7.2.8 Number of Multimedia Messages delivery report responses sent by MMS Relay/Server

- a) This measurement provides the number of Multimedia Messages (MM) delivery report responses sent by MMS Relay/Server from another MMS Relay/Server on the Reference point MM4. The measurement is split into subcounters per request status code.
- b) CC.
- c) On transmission of a "MM4\_delivery\_report.RES" message to MMS Relay/Server. Each delivery report response is added to the relevant measurement according to the request status code. See TS 23.140 [25].
- d) A single integer value.
- e) The measurement name has the form MMS.MM4RepResSnt Status.
- f) where Status identifies the request status code.
- g) MMS Relay/Server Function.
- h) Valid for packet switching.
- i) GSM/UMTS.

### 7.2.9 Number of Multimedia Messages read reply requests received by MMS Relay/Server

- a) This measurement provides the number of Multimedia Messages (MM) read reply requests received by MMS Relay/Server from another MMS Relay/Server on the Reference point MM4.
- b) CC.
- c) On receipt of a "MM4\_read\_reply.REQ" message from MMS Relay/Server (TS 23.140 [25]).
- d) A single integer value.
- e) The measurement name has the form MMS.MM4ReadReqRec.
- f) MMS Relay/Server Function.
- g) Valid for packet switching.
- h) GSM/UMTS.

### 7.2.10 Number of Multimedia Messages read reply requests sent by MMS Relay/Server

- a) This measurement provides the number of Multimedia Messages (MM) read reply requests sent by MMS Relay/Server from another MMS Relay/Server on the Reference point MM4.
- b) CC.
- c) On transmission of a "MM4\_read\_reply.REQ" message to MMS Relay/Server (TS 23.140 [25]).
- d) A single integer value.
- e) The measurement name has the form MMS.MM4ReadReqSnt.
- f) MMS Relay/Server Function.

- g) Valid for packet switching.
- h) GSM/UMTS.

### 7.2.11 Number of Multimedia Messages read reply responses received by MMS Relay/Server

- a) This measurement provides the number of Multimedia Messages (MM) read reply responses received by MMS Relay/Server from another MMS Relay/Server on the Reference point MM4. The measurement is split into subcounters per request status code.
- b) CC.
- c) On receipt of a "MM4\_read\_reply.RES" message from MMS Relay/Server. Each read reply response is added to the relevant measurement according to the request status code. See TS 23.140 [25].
- d) A single integer value.
- e) The measurement name has the form MMS.MM4ReadResRec Status.
- f) where Status identifies the request status code.
- g) MMS Relay/Server Function.
- h) Valid for packet switching.
- i) GSM/UMTS.

### 7.2.12 Number of Multimedia Messages read reply responses sent by MMS Relay/Server

- a) This measurement provides the number of Multimedia Messages (MM) read reply responses sent by MMS Relay/Server from another MMS Relay/Server on the Reference point MM4. The measurement is split into subcounters per request status code.
- b) CC.
- c) On transmission of a "MM4\_read\_reply.RES " message to MMS Relay/Server. Each read reply response is added to the relevant measurement according to the request status code. See TS 23.140 [25].
- d) A single integer value.
- e) The measurement name has the form MMS.MM4ReadResSnt Status.
- f) where Status identifies the request status code.
- g) MMS Relay/Server Function.
- h) Valid for packet switching.
- i) GSM/UMTS.

---

## Annex A (informative): Examples for "(n-1) out of n" approach

The measurements result values generated by a NE are often redundant, or the info contained in the measurement results can be obtained in a number of different ways.

The "(n-1) out of n" approach allows a vendor to implement a subset of 3GPP defined measurements, for example if there exists a relation ( $A+B=C$ ) then any 2 out of 3 defined measurements A, B, C are sufficient information to calculate the third ( $n=3$ ). In case there exists a relation ( $A+B+C=D$ ), then any 3 out of the 4 would suffice, and the same kind of approach would be applicable.

---

### A.1 Attempt/success/failure procedure measurements

Consider the number of attempts to start a specific procedure (e.g. RRC connection establishment). Some of these attempts will fail, some will be successful. Three different counters can be defined to measure these procedures: an attempt counter, a success counter, and a failure counter, but in fact only 2 may be provided, since we have the fixed relation ( $\#success + \#failure = \#attempt$ ).

It is to be noted that all combinations do not provide the same level of details. For example, in the case only  $\#attempt$  and  $\#success$  are provided, it will not be possible to retrieve the detailed failure causes.

The three measurement types defined in clause 4.4 are subject to the "(n-1) out of n" approach with  $n=3$ :

- Attempted RRC connection establishments.
- Failed RRC connection establishments.
- Successful RRC connection establishments.

The "(n-1) out of n" approach is also applicable for more complex measurements split according to a specific criterion, e.g. Queuing. For example, the CS measurements described in clause 4.1 are subject to a 4 out of 5 approach:

- Attempted RAB establishments for CS domain.
- Successful RAB establishments without queuing for CS domain.
- Failed RAB establishments without queuing for CS domain.
- Successful RAB establishments with queuing for CS domain.
- Failed RAB establishments with queuing for CS domain.

Any of the five measurements can be calculated from the four others but all combinations will not provide the same level of details (e.g. failure causes).

---

### A.2 GSM/UMTS combined measurements

With relation to the field H of the measurement template, a measurement indicated with GSM/UMTS is an example of the "(n-1) out of n" approach with  $n=3$  since  $(GSM + UMTS) = Combined$ .

In that case, all concerned measurements are included in the same template but the vendor may provide only 2 subcounters out of 3.

The measurement described in subclause 5.6.1 is subject to the "(n-1) out of n" approach with n=3:

- SM.AttActPdpContext (attempted context activation procedures with no distinction between GSM and UMTS).
- SM.AttActPdpContext.G (attempted context activation procedures for GSM only).
- SM.AttActPdpContext.U (attempted context activation procedures for UMTS only).

---

## A.3 Embedded "(n-1) out of n" approaches

It is also possible to combine the approaches described above. For example, the measurements described in subclause 5.5 are subject to the "(n-1) out of n" approach at two levels.

Firstly, measurements are split according to the CS/PS domain, for example:

- attempted CS SMS mobile originating;
- attempted PS SMS mobile originating;
- attempted SMS mobile originating;

where any of the three measurements can be calculated from the two others.

Secondly, each measurement provides 3 subcounters, for example for Attempted CS SMS mobile originating:

- SMS.AttMoCS;
- SMS.AttMoCS.G;
- SMS.AttMoCS.U;

where any of the three subcounters can be calculated from the two others.

---

# Annex B (informative): Top-Down Performance Measurement Definition Process

## B.1 Scope of this annex

Performance measurements within wireless telecommunications networks are required in order to meet the needs of the diverse community of end-users of those measurements. New features develop, networks evolve and operating conditions change without sufficient consideration given to the measurements needed to keep the network running efficiently. While Equipment Vendors define measurements to satisfy their particular needs, other perspectives, especially the voice of the Network Operator, are sometimes lost during Equipment Vendor development processes. Similarly, Network Operators sometimes request measurements without fully understanding who will be using the data or what actions those people will take based on the collected data. A coherent, simple, top-down methodology for defining performance measurements is lacking in the telecommunications industry.

This annex proposes a methodology to handle the above problems. In particular, multiple user communities have been defined representing the end-users of system measurements. Performance goals and measurements are defined considering these same user communities. The definition includes identification of specific problem scenarios and corrective actions to be taken by the appropriate user community.

Measurements defined using this methodology can be contributed to 3GPP SA5 for potential adoption and inclusion in the present document. It is believed that this methodology will help reduce development costs for the Equipment Vendors and reduce operational costs for the Network Operators.

---

## B.2 Overview

Performance measurements are important to the proper and efficient functioning of wireless telecommunications networks. They have numerous uses related to resource utilization, expansion planning, network optimisation, operating problem diagnosis and network availability monitoring. For the wireless telecommunications world, product performance measurements are necessary to support multiple communities of users.

In addition, once performance measurements are defined for a wireless telecommunication network they must be maintained. The evolution of a wireless telecommunication network for capacity increases and feature extensions leads to the evolution of the collected measurements. Performance measurements need to be added, modified and made obsolete from the overall measurement repository. These changes must be defined completely and accurately to meet the requirements of each community of users.

The development of a performance measurement life cycle process to oversee this need is proposed in this annex. The life cycle process addresses the multiple user communities whose perspectives are needed to supply the requirements for the performance measurements.

The proposed performance measurement life cycle process is a usage-based process. The basic Goal, Question, Metric (GQM) method is enhanced to define problem scenarios and corrective actions. These descriptions are not only used to filter out proposals for performance measurements that provide no defined benefit, but also support user community training in the use of the performance measurements.

The remainder of this annex is organised as follows.

- Clause B.3 defines Measurement User Communities for wireless telecommunications.
- Clause B.4 discusses the GQM and the Enhanced GQM methods.
- Clause B.5 discusses the measurement life cycle process.
- Clause B.6 provides conclusions.

---

## B.3 Measurement User Communities

One objective of Performance Management as a functional subset of operations and maintenance processes is to define sets of measurements. Typical definition criteria revolve around measuring activity within the network in terms of volume, speed and accuracy. While this approach produces measurement data it does not completely address the needs and uses of the multiple consumers of network performance measurement information. The Enhanced GQM methodology extends the measurement definition criteria to better satisfy multiple groups with diverse needs for these measurements.

A qualitative judgement as to the efficacy of a Performance Management subsystem is how well served these different groups are by the measurements provided. To better understand these needs, five generic categories of users, outlined definitions and examples of their needs and requirements for measurements taken from their wireless telecommunications network are defined. These groups are referred to as measurement user communities. These six communities are:

- 1) Network Operator's Business Community.
- 2) Network Operator's Maintenance Community.
- 3) Network Operator's Traffic Engineering Community.
- 4) Network Operator's Customer Care Community.
- 5) Equipment Vendor's Performance Modelling Community.
- 6) Equipment Vendor's Development Engineering Community.

### B.3.1 Network Operator Business Community

The first measurement user community is the Network Operator's Business Community. This community is defined under the assumption that the wireless telecommunications network is fully operational, adequately engineered for traffic load per quality of service definitions and in commercial service. The primary objective of this community is to guarantee the financial health and welfare of the Operating Company. They expect a properly configured wireless telecommunications network to supply the revenue per subscriber unit necessary to meet their financial goals.

An understanding of the elasticity of demand can help the Business Community maximize profits within their product pricing strategy as they alter prices according to various mixes of services. Typical measurements of interest to this community are those based on the actual volumes of calls completed by service type. This call volume information can lead to trends of usage over time. Correlation between price mix and call volumes can help to identify pricing strategies geared towards increasing revenue per subscriber unit.

### B.3.2 Network Operator Maintenance Community

The second measurement user community is the Network Operator's Maintenance Community. This community is defined under the assumption that the wireless telecommunications network is less than fully operational, adequately engineered for traffic load per quality of service definitions and in commercial service. The primary objective of this community is to reduce Mean Time to Repair faults that occur within the network equipment of the Operating Company.

The baseline metric for this community is the availability of the network equipment, where availability is composed of the sum of scheduled and unscheduled outages to the network equipment. Unscheduled outages are influenced by the inherent hardware and software quality of the products provided to the operating company. While the Maintenance Community has no direct control over that quality, they do have control over the second component of scheduled outage, Mean Time to Repair.

Mean Time to Repair is influenced by the Mean Time to Detect a fault. This community of user's defines measurements that support detecting or predicting faults within the network equipment.



Measurements that support this community can come from places other than the network equipment, itself. Several Operating Companies have been observed building information systems based on the data provided by Call Detail Records and Billing Records. Correlation is sought within these data between call faults and location within the Network. Detection of these faults serves a dual purpose: it allows the Operating Company a view of performance at the level of their Network Operator (the subscriber) and it allows the Maintenance Community to target specific network equipment for repair.

### B.3.3 Network Operator Traffic Engineering Community

The third measurement user community is the Network Operator's Traffic Engineering Community. This community is defined under the assumption that the wireless telecommunications network is fully operational, inadequately engineered for current or future traffic load per quality of service definitions and in commercial service. The primary objective of this community is to keep the capacity of the network equipment within 1) the Operating Company's design criteria for the quality of service based on growth of the subscriber base, 2) changes in usage patterns based on pricing strategies and 3) introduction of new services.

The baseline metric for this community is the trend in utilization of the network equipment. A fully instrumented network would allow the Operating Company to understand the trend in performance of their principle capital investment and any leased services. As these trends pass thresholds of performance, purchasing decisions or volume pricing discounts could be triggered.

### B.3.4 Network Operator Customer Care Community

The fourth measurement user community is the Network Operator's Customer Care Community. This community is defined under the assumption that the wireless telecommunications network is fully operational, functioning at a less than optimal level resulting in end-user dissatisfaction and in commercial service. The primary objective of this community is interfacing with the end-user customers of offered services for the purpose of establishing and maintaining end-user customer satisfaction. This may include customer care responsibilities such as Customer Relationship Management (CRM), Service Level Agreement (SLA) management, quality of service (or QoS) management, etc.

This community is interested in defining measurements related to the end-user customer experience with the network Operator's offered services in the areas of CRM, SLA, QoS, problem reports, etc. Decisions on how to best handle customer dissatisfaction or how to keep customers from becoming dissatisfied are based on these types of measurements.

### B.3.5 Equipment Vendor Performance Modelling Community

The fifth measurement user community is Equipment Vendor's Performance Modelling Community. This community is defined under the assumption that the wireless telecommunications network is fully operational, adequately engineered for traffic load per quality of service definitions and in some level of call capable service. The primary objective of this community is to guarantee that the models used during analysis and design phases conform to real-world observations of the network equipment of the Operating Company.

While this community is not within the Operating Company it still provides beneficial service to the Operating Company by managing the development of subsequent features that are in line with the actual performance characteristics of the network. Many decisions within the development life cycle depend on models developed prior to shipping the product. These models need to be calibrated to network performance once the product is released. Definition of measurements in concert with calibrating these models requires the direct involvement of the people developing the models.

The network that transports Network Management data often is the same network that carries call control traffic. Clearly, the knowledge of volume levels of this traffic during anomalous operating conditions is important in order to understand the total impact to call processing. This community would define measurements to allow the monitoring of this type of phenomena.

## B.3.6 Equipment Vendor Development Engineering Community

The sixth measurement user community is Equipment Vendor's Development Engineering Community. This community is also defined under the assumption that the wireless telecommunications network is fully operational, adequately engineered for traffic load per Quality of Service or Service Level Agreement definitions and in commercial service. The primary objective of this community is to guarantee that the implementations of the designs conform to real-world observations of the network equipment of the Operating Company.

While this community also is not within the Operating Company, it still provides beneficial service to the Operating Company. The implementation of new algorithms carries some finite risk of performance in the Network Operator environment versus the lab environment. Many times simulators of network activity are developed to support the verification of these algorithms. These simulations need to be calibrated to network performance once the product is released. Definition of measurements in concert with calibrating these simulations requires the direct involvement of the people developing the simulations.

## B.3.7 User Community Conclusion

The six measurement communities are broken into four Network Operator based groups and two Equipment Vendor groups. However, experience shows that the measurements defined for these groups are not mutually exclusive. Other groups may also use measurements needed by a particular group for the same or different purposes. Thus, the accurate definition of the measurements and how to use them is necessary to allow the Network Operator to properly combine these measurements into more complex analyses.

---

## B.4 Enhanced GQM

The Goal, Question, Metric (GQM) method requires measurement user communities to help define goals and metrics. This clause first presents the standard GQM method and then presents an enhanced GQM method, which provides the measurement user communities a broader understanding of how metrics are used. The term 'Metric' in GQM means the same as 'measurement'.

### B.4.1 GQM Methodology

Basili and Weiss [23] and others originally proposed the GQM method. This methodology provides a systematic approach for defining metrics that can be collected and analysed to determine whether or not a goal has been reached. This methodology was originally created for quality assurance of software development processes, but has been applied to other areas. GQM is comprised of the following three steps.

1. Identify and define **Goals** for a particular group;
2. Refine goals into quantifiable **Questions**;
3. Define **Metrics** that will answer the questions.

Goals are defined in terms of a **purpose** and a **perspective**. The purpose specifies the object to be analysed and why it will be analysed. The perspective specifies the relevant aspects of the object and which measurement user community is interested in the aspects.

Execution of the GQM methodology results in the formation of a GQM model. A GQM model contains the set of defined Goals, Questions and Metrics. A GQM model provides trace-ability from the goals to the associated metrics. Figure B1 shows an example of a GQM model.

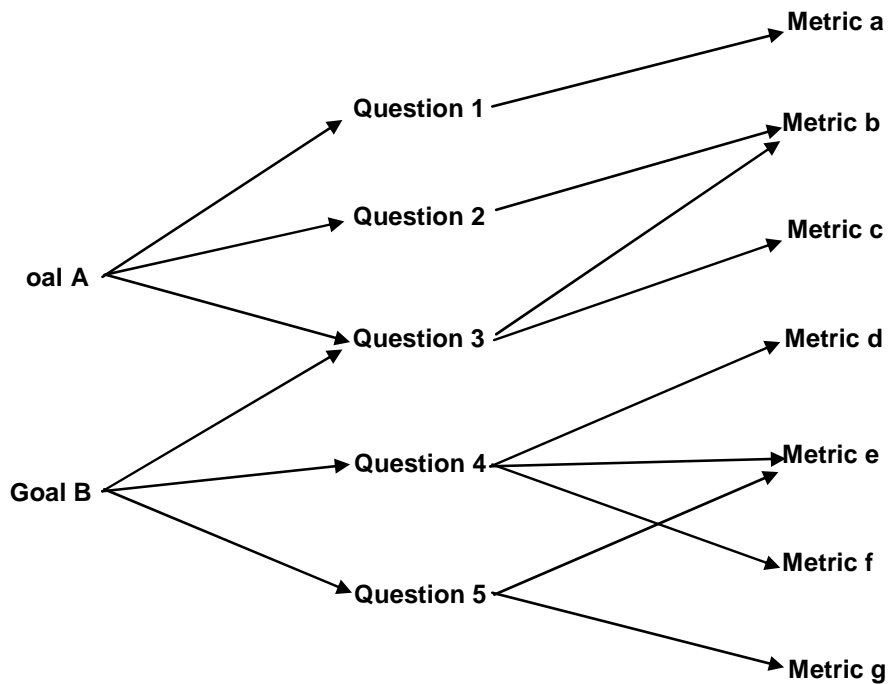

**Figure B1: GQM Model**

GQM definition templates are often used to help produce consistent goal, question and/or metric definitions. An example of a Goal template is shown below [22]:

**Purpose:** To (characterize evaluate, predict, motivate, etc.) the (process product model, metric, etc.) in order to (understand, assess, manage, engineer, learn, improve, etc.) it.  
Example: To evaluate the system testing methodology in order to improve it.

**Perspective:** Examine the (cost, effectiveness, correctness, defects, changes, product metrics, reliability, etc.) from the point of view of the (developer, manager, Network Operator, corporate perspective, etc.).  
Example: Examine the effectiveness from the developer's point of view.

## B.4.2 Enhanced GQM (EGQM) Methodology

As it stands, the GQM methodology works well for defining metrics, but falls short in several areas. The original GQM methodology was enhanced to better fit within the wireless telecommunications industry for the following reasons:

- a) Allow wireless measurement user communities to specify their needs at the beginning of the performance measurement life cycle rather than waiting for product to be delivered.
- b) Allow wireless measurement user communities to understand what performance measurements are being designed for them in time to modify the associated collection, analysis and reporting processes.
- c) Allow wireless measurement user communities to understand how they should analyse collected measurement data and what actions they should take when analysis has been completed.
- d) Provide criteria for rejecting unnecessary goals, useless measurements, or measurements that can not be properly collected, analysed or understood.
- e) Provide criteria for architecting metrics into the appropriate wireless network device (based on network traffic capacity, device CPU and memory capacity, data collection capabilities, etc.).
- f) Allow for consistent measurement definition by providing Enhanced GQM model definition and measurement definition templates.
- g) Help reduce development costs for Equipment Providers and reduce operational costs for the Network Operator.

The Enhanced GQM, or EGQM, methodology is comprised of the following four steps.

1. Identify and define measurement goals for a particular measurement user community;
2. Refine measurement goals into quantifiable problem scenarios;
3. Define measurements that will determine if the goal is being accomplished;
4. Define corrective actions.

EGQM's first and third steps are similar to GQM's first and third steps. EGQM's second step is different than GQM's second step in that it focuses on problem scenarios associated with the goal rather than on questions associated with the goal. Problem scenarios are descriptions of real world problems the measurement user community has or will experience. Each problem scenario represents a particular aspect of the associated goal. Problem scenarios include definitions of any formulas that will allow the measurement user community to analyse the problem scenario after metric data has been collected from the field. EGQM's fourth step is new. Corrective actions are descriptions of what the measurement user community should do based on analysis of metric data collected from the resulting wireless network.

Execution of the EGQM methodology results in the formation of an EGQM model. An EGQM model contains the set of defined goal, problem scenarios, metrics and corrective actions. An EGQM model also provides trace-ability from the goals to the associated corrective actions. Figure B2 shows an example of an EGQM model.

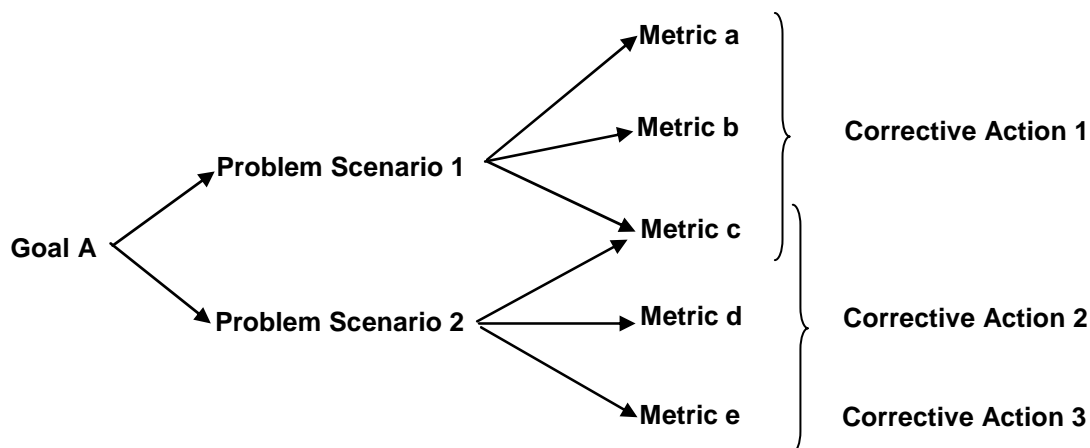

Figure B2: EGQM Model

EGQM has definition templates for producing an EGQM model and for defining metrics. The EGQM model definition template is shown in Table B1. The EGQM metric definition template that is useful for 3GPP SA5 activities is defined in subclause 3.3 of the present document.

Table B1: EGQM Model Definition Template

<b>Goal</b>	Provides the name of goal and non-ambiguous definition of what needs to be accomplished. Also provides the measurement user communities the goal is associated with.
<b>Problem Scenario(s)</b>	Provides a description of the problem scenario associated with the goal. Contains a description of how performance measurements will be used by the user in order to meet the goal.
<b>Required Metric(s)</b>	Provides a list of metrics required to assess the problem scenario to see if the goal is being accomplished.
<b>Corrective Action(s)</b>	Provides descriptions of actions the user can execute based on data collected from the wireless network. Contains descriptions of expected metric data values and how those values work with the Problem Scenarios definitions.

As described in clause B.3, six measurement user communities have been defined for the wireless telecommunications industries. EGQM supports all six communities. Representatives from each community participate in all four steps of the EGQM methodology. This allows user communities to specify exactly what they need and/or want and to know exactly how they will use the metrics before any software is developed. Participation in the EGQM process increases Network Operator satisfaction through early definition of operational practices (including corrective actions) and increases product knowledge within the Network Operator organization.

The EGQM model definition and metric definition templates provide the mechanism to reject unnecessary goals, useless metrics, or metrics that can't be properly collected or computed. Reasons for the rejection of a goal include the following:

- a) Non-ambiguous goal definition could not be determined;
- b) Problem scenarios could not be determined;
- c) Definition of how performance measurement will be used within a problem scenario could not be determined;
- d) Corrective actions could not be determined;
- e) Metrics could not be defined to support problem scenario definitions;
- f) Required metrics could not be architected into network devices for any of the following reasons:
  - 1) Network device could not collect metric due to CPU utilization issues;
  - 2) Network device could not collect and/or store metric due to memory issues;
  - 3) Network could not support the uploading of measurement data from network devices to network manager;
  - 4) Network manager could not collect and/or store measurement data due to memory issues.

---

## B.5 Measurements Life Cycle Process

If the uses of performance measurements were confined to feature releases and occasional changes to those features, then EGQM would suffice. However, user community needs evolve, operating conditions change, performance models are validated, new services are introduced, etc. As these conditions change, performance measurements may need to change. Such considerations point to the need for a complete measurements life cycle model.

A simple life cycle model to handle performance measurement changes is depicted in Figure B3. New performance measurement goal and metric definitions are provided through new features. These are made available with major releases.

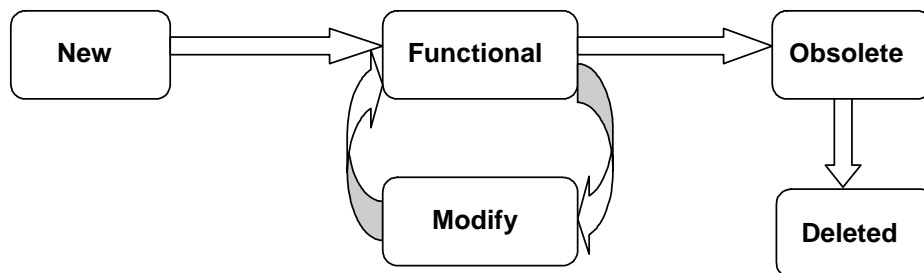

**Figure B3: Measurement Life Cycle**

Performance measurements may need to be periodically reviewed. Goal and metric definition updates made during this process are generally instantiated at major releases. When metrics are no longer useful they can be made obsolete and eventually deleted. A waiting period between obsolescence and deletion allows user communities time to implement and test out new metrics and analyses that are meant to replace existing metrics and analyses.

---

## B.6 Conclusion

In the past, definition of performance measurements of wireless telecommunications networks was focused mainly on satisfying the needs of the Equipment Vendor Performance Modelling and Development Engineering measurement user communities. The needs of the wireless telecommunications Network Operator were not always addressed. The Performance Measurement Definition process described in this annex addresses the needs of all measurements user communities. The process also provides additional benefits, including the following:

- Allow measurement communities to specify their needs up front.
- Allow measurement communities to prepare for and modify their measurement monitoring and reporting processes before product is released to them.
- Allow measurement communities to know what actions they need to perform when assessing collected measurements.
- Provides method for rejecting unrealistic goals and measurements.
- Provides method for best architecting measurements into network devices.
- Provides method for producing consistent measurement definitions.
- Provides method for managing measurements life cycle including measurement creation, modification and obsolescence.

The EGQM methodology may be used for:

- analyse and assess performance areas that are not well understood or are highly complex;
- non-straightforward cases where it is difficult to create useful measurement proposals;
- an understanding of real value is required before useful measurement proposals can be created;
- mine for missing measurements;
- mine for conflicting, overlapping, or existing measurements that are no longer useful.

In summary, the EGQM methodology may be used by any company to generate measurement definitions that can then be contributed to 3GPP SA5 for potential inclusion in the present document.

## Annex C (informative): Change history

Change history								
Date	TSG #	TSG Doc.	CR	Rev	Subject/Comment	Cat	Old	New
Jun 2001	SA_12	SP-010237	--	--	Submitted to TSG SA #12 for Approval.	--	1.0.2	4.0.0
Sep 2001	SA_13	SP-010468	0001	--	Corrections on UMTS and combined UMTS/GSM measurements: Addition of family name for CN measurements, addition of the list of families, addition of Annex A: "(n-1) out of n" examples, application of the "(n-1) out of n" approach to all relevant measurements, enhancement of per cause measurements	F	4.0.0	4.1.0
Mar 2002	SA_15	SP-020026	0002	--	Correction of the measured object class for some SGSN MM measurement definitions	F	4.1.0	4.2.0
Mai 2002	--	--	--	--	MCC clean-up (Cosmetics based on EditHelp)	--	4.2.0	4.2.1
Jun 2002	SA_16	SP-020291	0003	2	Introduction of "Performance Measurements Definition Process" describing the repeatable, top-down process to define measurements for inclusion in future 3GPP Releases	F	4.2.0	5.0.0
Jun 2002	SA_16	SP-020291	0004	--	Adding performance measurement definitions related to GGSN	B	4.2.0	5.0.0
Jun 2002	SA_16	SP-020291	0005	--	Introduction of an optional "Purpose" clause in the measurement template	B	4.2.0	5.0.0
Jun 2002	SA_16	SP-020291	0006	--	Addition of explanatory text for Radio Access Bearer (RAB) measurements	D	4.2.0	5.0.0
Sep 2002	SA_17	SP-020609	0009	--	Introduction of Service Based Performance Measurement Definitions	B	5.0.0	5.1.0
Sep 2002	SA_17	SP-020609	0010	--	Add flexibility in the measurement template for the Measured Object Class (MOC)	C	5.0.0	5.1.0
Mar 2003	SA_19	SP-030146	0012	--	Correction of the subscriber number measurement definitions	A	5.1.0	5.2.0
Jun 2003	SA_20	SP-030292	0014	--	Correction of the definition of the successful GPRS attach counters	A	5.2.0	5.3.0
Jun 2003	SA_20	SP-030292	0015	--	Deletion of dual clause 4.1.2	F	5.2.0	5.3.0
Jun 2003	SA_20	SP-030293	0016	--	Addition of GPRS per cause measurement definitions	C	5.3.0	6.0.0
Jun 2003	SA_20	SP-030293	0017	--	Introduction of MMS Service Based Performance Measurement	B	5.3.0	6.0.0
Sep 2003	SA_21	SP-030431	0020	--	Correction of collection method for SGSN measurements	A	6.0.0	6.1.0
Sep 2003	SA_21	SP-030431	0023	--	Correction of "outgoing intra-cell hard handovers measurements"	A	6.0.0	6.1.0
Dec 2003	SA_22	SP-030645	0025	--	Correction of terms used for subcounter definitions	A	6.1.0	6.2.0
Mar 2004	SA_23	SP-040134	0028	--	Correction of "Radio link addition" measurements	A	6.2.0	6.3.0
Mar 2004	SA_23	SP-040135	0029	--	Add the measurements about lu connection release	B	6.2.0	6.3.0
Jun 2004	SA_24	SP-040266	0032	--	Correction of "Inter-RAT handover" measurements	A	6.3.0	6.4.0
Jun 2004	SA_24	SP-040267	0035	--	Correction of "RAB assignment" measurements	B	6.3.0	6.4.0
Jun 2004	SA_24	SP-040269	0038	--	Correction of "hard handover" measurement definitions	A	6.3.0	6.4.0
Jun 2004	SA_24	SP-040270	0039	--	Addition of the measurements about RAB modification and RAB release by CN	B	6.3.0	6.4.0
Sep 2004	SA_25	SP-040574	0040	--	Restructure clauses 5 and 6 to follow the style of other clauses related to UTRAN measurements for extensibility	D	6.4.0	6.5.0
Sep 2004	SA_25	SP-040574	0041	--	Add measurements about Mobility Management	B	6.4.0	6.5.0
Sep 2004	SA_25	SP-040574	0042	--	Add measurements about "PDP context activation procedures initiated by Network"	B	6.4.0	6.5.0
Sep 2004	SA_25	SP-040574	0043	--	Add measurements about relocation	B	6.4.0	6.5.0
Sep 2004	SA_25	SP-040574	0044	--	Change of the measurements about "SRNS Relocation"	C	6.4.0	6.5.0
Sep 2004	SA_25	SP-040574	0045	--	Split measurements about successful PDP context deactivation	C	6.4.0	6.5.0
Sep 2004	SA_25	SP-040575	0048	--	Correction of "Mobility Management" GPRS attach measurement definitions	A	6.4.0	6.5.0
Sep 2004	SA_25	SP-040577	0053	--	Add missing Measurement Name Length constraints	A	6.4.0	6.5.0
Dec 2004	SA_26	SP-040783	0056	--	Correct measurements about GPRS Update Locations sent to the HLR	A	6.5.0	6.6.0
Mar 2005	SA_27	SP-050040	0059	--	Correction of measurements on Number of GTP data packets sent and received on the Gn interface	A	6.6.0	6.7.0
Mar 2005	SA_27	SP-050040	0060	--	Add measurements on Number of GTP data packets sent and received on the Gn interface, from SGSN to SGSN	B	6.6.0	6.7.0
Jun 2005	SA_28	SP-050293	0061	--	Correction of measurement type name to RAB.SuccRelPSNoQueuing	F	6.7.0	6.8.0
Jun 2005	SA_28	SP-050293	0062	--	Add missing GSM SGSN measurements for subscribers state	F	6.7.0	6.8.0
Jun 2005	SA_28	SP-050293	0063	--	Add missing SGSN measurements for GSM ciphering procedures	F	6.7.0	6.8.0
Jun 2005	SA_28	SP-050293	0065	--	Correct inter-RAT handover measurement object class UtranRelation to GsmRelation	A	6.7.0	6.8.0
Jun 2005	SA_28	SP-050293	0066	--	Add missing UMTS/GSM SGSN measurements for IMEI checking	F	6.7.0	6.8.0
Jun 2005	SA_28	SP-050293	0067	--	Add missing UMTS/GSM SGSN measurements for failed PS paging procedures	F	6.7.0	6.8.0
Jun 2005	SA_28	SP-050293	0068	--	Add missing GSM SGSN measurements for LLC protocol and SNDCCP protocol	F	6.7.0	6.8.0
Jun 2005	SA_28	SP-050293	0069	--	Add missing SGSN/GGSN measurements for max number of subscribers	F	6.7.0	6.8.0
Sep 2005	SA_29	SP-050451	0071	--	Correct successful inter-SGSN Routing Area update procedures	A	6.8.0	6.9.0
Sep 2005	SA_29	SP-050451	0073	--	Delete wrongly defined Measurements about 'Intra-Cell Hard handover'	A	6.8.0	6.9.0

Sep 2005	SA_29	SP-050451	0075	--	Correct incoherent SHO prefixed FDD/TDD radio link management measurements	A	6.8.0	6.9.0
Sep 2005	SA_29	SP-050460	0076	--	Inconsistent description on the scope of measurements types	F	6.8.0	6.9.0
Sep 2005	SA_29	SP-050460	0077	--	Remove ambiguity in 'Successful UMTS PS paging procedures'	F	6.8.0	6.9.0



---

## History

<b>Document history</b>		
V6.6.0	December 2004	Publication
V6.7.0	March 2005	Publication
V6.8.0	June 2005	Publication
V6.9.0	September 2005	Publication