

ETSI TS 132 405 V7.5.0 (2007-06)

Technical Specification

**Digital cellular telecommunications system (Phase 2+);
Universal Mobile Telecommunications System (UMTS);
Telecommunication management;
Performance Management (PM);
Performance measurements
Universal Terrestrial Radio Access Network (UTRAN)
(3GPP TS 32.405 version 7.5.0 Release 7)**



Reference

DTS/TSGS-0532405v750

Keywords

GSM, UMTS

ETSI

650 Route des Lucioles
F-06921 Sophia Antipolis Cedex - FRANCE

Tel.: +33 4 92 94 42 00 Fax: +33 4 93 65 47 16

Siret N° 348 623 562 00017 - NAF 742 C
Association à but non lucratif enregistrée à la
Sous-Préfecture de Grasse (06) N° 7803/88

Important notice

Individual copies of the present document can be downloaded from:

<http://www.etsi.org>

The present document may be made available in more than one electronic version or in print. In any case of existing or perceived difference in contents between such versions, the reference version is the Portable Document Format (PDF). In case of dispute, the reference shall be the printing on ETSI printers of the PDF version kept on a specific network drive within ETSI Secretariat.

Users of the present document should be aware that the document may be subject to revision or change of status. Information on the current status of this and other ETSI documents is available at

<http://portal.etsi.org/tb/status/status.asp>

If you find errors in the present document, please send your comment to one of the following services:

http://portal.etsi.org/chaicor/ETSI_support.asp

Copyright Notification

No part may be reproduced except as authorized by written permission.
The copyright and the foregoing restriction extend to reproduction in all media.

© European Telecommunications Standards Institute 2007.
All rights reserved.

DECTTM, **PLUGTESTS**TM and **UMTS**TM are Trade Marks of ETSI registered for the benefit of its Members.
TIPHONTM and the **TIPHON logo** are Trade Marks currently being registered by ETSI for the benefit of its Members.
3GPPTM is a Trade Mark of ETSI registered for the benefit of its Members and of the 3GPP Organizational Partners.

Intellectual Property Rights

IPRs essential or potentially essential to the present document may have been declared to ETSI. The information pertaining to these essential IPRs, if any, is publicly available for **ETSI members and non-members**, and can be found in ETSI SR 000 314: *"Intellectual Property Rights (IPRs); Essential, or potentially Essential, IPRs notified to ETSI in respect of ETSI standards"*, which is available from the ETSI Secretariat. Latest updates are available on the ETSI Web server (<http://webapp.etsi.org/IPR/home.asp>).

Pursuant to the ETSI IPR Policy, no investigation, including IPR searches, has been carried out by ETSI. No guarantee can be given as to the existence of other IPRs not referenced in ETSI SR 000 314 (or the updates on the ETSI Web server) which are, or may be, or may become, essential to the present document.

Foreword

This Technical Specification (TS) has been produced by ETSI 3rd Generation Partnership Project (3GPP).

The present document may refer to technical specifications or reports using their 3GPP identities, UMTS identities or GSM identities. These should be interpreted as being references to the corresponding ETSI deliverables.

The cross reference between GSM, UMTS, 3GPP and ETSI identities can be found under <http://webapp.etsi.org/key/queryform.asp>.

Contents

Intellectual Property Rights	2
Foreword.....	2
Foreword.....	9
1 Scope	11
2 References	11
3 Measurement family and abbreviations.....	12
3.1 Measurement family.....	12
3.2 Abbreviations	12
4 Measurements related to the RNC.....	14
4.1 RAB management	14
4.1.1 Overview	14
4.1.1.1 Measurements are based on the success and failure of procedures	14
4.1.1.2 Combination of Traffic Class and Core Network domains	14
4.1.1.3 Considered Radio Access Bearer management procedures	14
4.1.1.4 Measurements relate to RAB establishment, modification and release	15
4.1.2 RAB establishment for CS domain.....	15
4.1.2.1 Attempted RAB establishments for CS domain.....	15
4.1.2.2 Successful RAB establishments without queuing for CS domain.....	16
4.1.2.3 Failed RAB establishments without queuing for CS domain.....	17
4.1.2.4 Successful RAB establishments with queuing for CS domain.....	17
4.1.2.5 Failed RAB establishments with queuing for CS domain.....	18
4.1.3 RAB establishment for PS domain	18
4.1.3.1 Attempted RAB establishments for PS domain	18
4.1.3.2 Successful RAB establishments without queuing for PS domain	19
4.1.3.3 Failed RAB establishments without queuing for PS domain	19
4.1.3.4 Successful RAB establishments with queuing for PS domain	20
4.1.3.5 Failed RAB establishments with queuing for PS domain	20
4.1.4 RAB modification for CS domain	21
4.1.4.1 Attempted RAB modifications for CS domain	21
4.1.4.2 Successful RAB modifications without queuing for CS domain	21
4.1.4.3 Failed RAB modifications without queuing for CS domain	22
4.1.4.4 Successful RAB modifications with queuing for CS domain	22
4.1.4.5 Failed RAB modifications with queuing for CS domain	22
4.1.5 RAB modification for PS domain.....	23
4.1.5.1 Attempted RAB modifications for PS domain.....	23
4.1.5.2 Successful RAB modifications without queuing for PS domain.....	23
4.1.5.3 Failed RAB modifications without queuing for PS domain.....	24
4.1.5.4 Successful RAB modifications with queuing for PS domain.....	24
4.1.5.5 Failed RAB modifications with queuing for PS domain.....	25
4.1.6 RAB release request by CN for CS domain.....	25
4.1.6.1 Attempted RAB releases for CS domain.....	25
4.1.6.2 Successful RAB releases for CS domain	26
4.1.6.3 Failed RAB releases for CS domain.....	26
4.1.7 RAB release request by CN for PS domain	27
4.1.7.1 Attempted RAB releases for PS domain	27
4.1.7.2 Successful RAB releases for PS domain	27
4.1.7.3 Failed RAB releases for PS domain	27
4.1.7.4 Void.....	28
4.1.7.5 Void.....	28
4.1.8 RAB setup time.....	28
4.1.8.1 RAB CS connection set-up time (Mean).....	28
4.1.8.2 RAB CS connection set-up time (Maximum)	28
4.1.8.3 RAB PS connection set-up time (Mean)	29

4.1.8.4	RAB PS connection set-up time (Maximum).....	29
4.1.9	RAB release request by UTRAN	30
4.1.9.1	RAB release requests for CS domain	30
4.1.9.2	RAB release requests for PS domain	30
4.1.9.3	The number of RAB related to the Iu release request for CS domain	30
4.1.9.4	The number of RAB related to the Iu release request for PS domain	31
4.2	Void.....	31
4.3	Signalling connection establishment	31
4.3.1	Attempted signalling connection establishments for CS domain.....	31
4.3.2	Attempted signalling connection establishments for PS domain	32
4.4	RRC connection establishment.....	32
4.4.1	RRC connection establishments	32
4.4.1.1	Attempted RRC connection establishments	32
4.4.1.2	Failed RRC connection establishments.....	32
4.4.1.3	Successful RRC connection establishments.....	33
4.4.2	RRC connection establishment setup time.....	33
4.4.2.1	RRC connection set-up time (Mean).....	33
4.4.2.2	RRC connection set-up time (Max)	34
4.4.3	RRC connection usage.....	35
4.4.3.1	General	35
4.4.3.2	RRC connection usage (Mean)	35
4.4.3.3	RRC connection usage (Maximum).....	35
4.5	RRC connection re-establishment	36
4.5.1	Attempted RRC re-establishments.....	36
4.5.2	Failed RRC re-establishments.....	36
4.5.3	Successful RRC re-establishments	36
4.6	RRC connection release	37
4.6.1	Attempted RRC connection releases on DCCH.....	37
4.6.2	Attempted RRC connection releases on CCCH.....	37
4.7	RLC connection.....	38
4.7.1	Number of RLC blocks sent (per Mode)	38
4.7.2	Number of RLC blocks Received (per Mode).....	38
4.7.3	Discarded RLC blocks by RNC.....	38
4.7.4	Number of Retransmitted RLC blocks in Acknowledge Mode	39
4.8	Soft handover	39
4.8.1	Radio link additions to active link set (UE side).....	39
4.8.1.1	Attempted radio link additions to active link set (UE side)	39
4.8.1.2	Successful radio link additions to active link set (UE side)	39
4.8.1.3	Failed radio link additions to active link set (UE side)	40
4.8.2	Radio link deletions from active link set (UE side)	40
4.8.2.1	Attempted radio link deletions from active link set (UE side).....	40
4.8.2.2	Successful radio link deletions from active link set (UE side).....	41
4.8.3	Measurements related to the soft handover radio link	41
4.8.3.1	Mean number of the radio link established by the best UTRAN cell.....	41
4.8.3.2	Mean number of the radio link established by other UTRAN cell.....	41
4.9	Radio link management procedures	42
4.9.1	Overview	42
4.9.1.1	Considered radio link management procedures	42
4.9.1.2	Relation between Iub measurements and Iur measurements.....	45
4.9.2	Radio link setups on Iub	45
4.9.2.1	Attempted radio link setups on Iub	45
4.9.2.2	Successful radio link setups on Iub	46
4.9.2.3	Failed radio link setups on Iub	46
4.9.3	Radio link setups on Iur	47
4.9.3.1	Attempted radio link setups on Iur.....	47
4.9.3.2	Successful radio link setups on Iur.....	47
4.9.3.3	Failed radio link setups on Iur.....	48
4.9.4	Radio link additions on Iub.....	48
4.9.4.1	Attempted radio link additions on Iub.....	48
4.9.4.2	Successful radio link additions on Iub	49
4.9.4.3	Failed radio link additions on Iub	49
4.9.5	Radio link additions on Iur	50

4.9.5.1	Attempted radio link additions on Iur	50
4.9.5.2	Successful radio link additions on Iur	50
4.9.5.3	Failed radio link additions on Iur	50
4.9.6	Radio link deletions on Iub	51
4.9.6.1	Attempted radio link deletions on Iub	51
4.9.6.2	Successful radio link deletions on Iub	51
4.9.7	Radio link deletions on Iur	52
4.9.7.1	Attempted radio link deletions on Iur	52
4.9.7.2	Successful radio link deletions on Iur	52
4.10	Hard handover	52
4.10.1	Void	52
4.10.2	Outgoing intra-NodeB hard handovers	52
4.10.2.1	Attempted outgoing intra-NodeB hard handovers	53
4.10.2.2	Successful outgoing intra-NodeB hard handovers	53
4.10.2.3	Failed outgoing intra-NodeB hard handovers	53
4.10.3	Outgoing inter-NodeB, intra-RNC hard handovers	54
4.10.3.1	Attempted outgoing inter-NodeB, intra-RNC hard handovers	54
4.10.3.2	Successful outgoing inter-NodeB, intra-RNC hard handovers	54
4.10.3.3	Failed outgoing inter-NodeB, intra-RNC hard handovers	55
4.10.4	Outgoing inter-RNC hard handovers via Iur	55
4.10.4.1	Attempted outgoing inter-RNC hard handovers via Iur	55
4.10.4.2	Successful outgoing inter-RNC hard handovers via Iur	56
4.10.4.3	Failed outgoing inter-RNC hard handovers via Iur	56
4.10.5	Relocation preparation for outgoing inter-RNC hard handovers switching in the CN	57
4.10.5.1	Attempted relocation preparation for outgoing inter-RNC hard handovers switching in the CN	57
4.10.5.2	Successful relocation preparation for outgoing inter-RNC hard handovers switching in the CN	57
4.10.5.3	Failed relocation preparation for outgoing inter-RNC hard handovers switching in the CN	57
4.10.6	Outgoing inter-RNC hard handovers switching in the CN	58
4.10.6.1	Attempted outgoing inter-RNC hard handovers switching in the CN	58
4.10.6.2	Successful outgoing inter-RNC hard handovers switching in the CN	58
4.10.6.3	Failed outgoing inter-RNC hard handovers switching in the CN	59
4.10.7	Outgoing hard handovers per neighbour cell relation	59
4.10.7.1	Attempted outgoing hard handovers per neighbour cell relation	59
4.10.7.2	Successful outgoing hard handovers per neighbour cell relation	60
4.10.7.3	Failed outgoing hard handovers per neighbour cell relation	60
4.11	Relocation	61
4.11.1	Relocations for CS domain	61
4.11.1.1	Relocation preparations with UE involved for CS domain	61
4.11.1.1.1	Attempted relocation preparations with UE involved for CS domain	61
4.11.1.1.2	Successful relocation preparations with UE involved for CS domain	61
4.11.1.1.3	Failed relocation preparations with UE involved for CS domain	61
4.11.1.2	Relocation preparations with UE not involved for CS domain	62
4.11.1.2.1	Attempted relocation preparations with UE not involved for CS domain	62
4.11.1.2.2	Successful relocation preparations with UE not involved for CS domain	62
4.11.1.2.3	Failed relocation preparations with UE not involved for CS domain	63
4.11.1.3	Relocation resource allocations with UE involved for CS domain	63
4.11.1.3.1	Attempted relocations resource allocations with UE involved for CS domain	63
4.11.1.3.2	Successful relocation resource allocations with UE involved for CS domain	64
4.11.1.3.3	Failed relocation resource allocations with UE involved for CS domain	64
4.11.1.4	Relocation resource allocations with UE not involved for CS domain	64
4.11.1.4.1	Attempted relocations resource allocations with UE not involved for CS domain	64
4.11.1.4.2	Successful relocation resource allocations with UE not involved for CS domain	65
4.11.1.4.3	Failed relocation resource allocations with UE not involved for CS domain	65
4.11.1.5	Relocations for CS domain	66
4.11.1.5.1	Successful relocations for CS domain	66
4.11.2	Relocations for PS domain	66
4.11.2.1	Relocation preparations with UE involved for PS domain	66
4.11.2.1.1	Attempted relocation preparations with UE involved for PS domain	66
4.11.2.1.2	Successful relocation preparations with UE involved for PS domain	66
4.11.2.1.3	Failed relocation preparations with UE involved for PS domain	67
4.11.2.2	Relocation preparations with UE not involved for PS domain	67
4.11.2.2.1	Attempted relocation preparations with UE not involved for PS domain	67

4.11.2.2.2	Successful relocation preparations with UE not involved for PS domain	68
4.11.2.2.3	Failed relocation preparations with UE not involved for PS domain	68
4.11.2.3	Relocation resource allocations with UE involved for PS domain	68
4.11.2.3.1	Attempted relocations resource allocations with UE involved for PS domain	68
4.11.2.3.2	Successful relocation resource allocations with UE involved for PS domain	69
4.11.2.3.3	Failed relocation resource allocations with UE involved for PS domain	69
4.11.2.4	Relocation resource allocations with UE not involved for PS domain	70
4.11.2.4.1	Attempted relocations resource allocations with UE not involved for PS domain	70
4.11.2.4.2	Successful relocation resource allocations with UE not involved for PS domain	70
4.11.2.4.3	Failed relocation resource allocations with UE not involved for PS domain	70
4.11.2.5	Relocations for PS domain	71
4.11.2.5.1	Successful relocations for PS domain	71
4.12	Circuit switched inter-RAT handover	71
4.12.1	Relocation preparation for outgoing circuit switched inter-RAT handovers	71
4.12.1.1	Attempted relocation preparation for outgoing circuit switched inter-RAT handovers	71
4.12.1.2	Successful relocation preparation for outgoing circuit switched inter-RAT handovers	72
4.12.1.3	Failed relocation preparation for outgoing circuit switched inter-RAT handovers	72
4.12.2	Outgoing circuit switched inter-RAT handovers	72
4.12.2.1	Attempted outgoing circuit switched inter-RAT handovers	72
4.12.2.2	Successful outgoing circuit switched inter-RAT handovers	73
4.12.2.3	Failed outgoing circuit switched inter-RAT handovers	73
4.12.3	Incoming circuit switched inter-RAT handovers	73
4.12.3.1	Attempted incoming circuit switched inter-RAT handovers	73
4.12.3.2	Successful incoming circuit switched inter-RAT handovers	74
4.12.3.3	Failed incoming circuit switched inter-RAT handovers	74
4.13	Packet switched inter-RAT handover	74
4.13.1	Outgoing packet switched inter-RAT handovers, UTRAN controlled	74
4.13.1.1	Attempted outgoing packet switched inter-RAT handovers, UTRAN controlled	75
4.13.1.2	Successful outgoing packet switched inter-RAT handovers, UTRAN controlled	75
4.13.1.3	Failed outgoing packet switched inter-RAT handovers UTRAN controlled	75
4.13.2	Outgoing packet switched inter-RAT handovers, UE controlled	76
4.13.2.1	Successful outgoing packet switched inter-RAT handovers, UE controlled	76
4.14	Iu connection release	76
4.14.1	Overview	76
4.14.1.1	Considered Iu connection release procedures	76
4.14.2	Iu connection release request by UTRAN	77
4.14.2.1	Attempted Iu connection release request by UTRAN for CS domain	77
4.14.2.2	Attempted Iu connection release request by UTRAN for PS domain	77
4.14.3	Iu connection release by CN	78
4.14.3.1	Attempted Iu connection release by CN for CS domain	78
4.14.3.2	Attempted Iu connection release by CN for PS domain	78
4.14.3.3	Successful Iu connection release by CN for CS domain	79
4.14.3.4	Successful Iu connection release by CN for PS domain	79
4.15	Intra-cell DCA	79
4.15.1	Attempted intra-cell DCA	79
4.15.2	Successful intra-cell DCA	80
4.15.3	Failed intra-cell DCA	80
4.16	TDD Code Resources	81
4.16.1	UTRAN Cell Max Downlink Code Resources Used	81
4.16.2	UTRAN Cell Max Uplink Code Resources Used	81
4.16.3	Mean Downlink Code Resources Used of an UTRAN Cell	82
4.16.4	Mean Uplink Code Resources Used of an UTRAN Cell	82
4.17	Measurements related to TDD UTRAN cell Radio Frequency Carrier	82
4.17.1	Mean Transmitted Carrier Power of an UTRAN Cell	82
4.17.2	Maximum Transmitted Carrier Power of an UTRAN Cell	83
4.17.3	Mean Received Total Wideband Power of an UTRAN Cell	83
4.17.4	The Maximum Received Total Wideband Power of an UTRAN Cell	84
4.17.5	Mean DPCH Transmitted Code Power of an UTRAN Cell	84
4.17.6	Maximum DPCH Transmitted Code Power of an UTRAN Cell	85
4.17.7	Mean DPCH Received Signal Code Power of an UTRAN Cell	85
4.17.8	Maximum DPCH Received Signal Code Power of an UTRAN Cell	85
4.17.9	Mean Interference Signal Code Power of an UTRAN Cell	86

4.17.10	Maximum Interference Signal Code Power of an UTRAN Cell.....	86
4.17.11	Mean transmitted carrier power of all codes not used for HS-PDSCH or HS-SCCH transmission	87
4.17.12	Maximum transmitted carrier power of all codes not used for HS-PDSCH or HS-SCCH transmission	87
4.18	Measurements related to the UTRAN cell FDD carrier (RF Performance metrics).....	88
4.18.1	Mean Transmitted Carrier Power of an UTRAN Cell	88
4.18.2	Maximum Transmitted Carrier Power of an UTRAN Cell.....	88
4.18.3	Mean Received Total Wideband Power of an UTRAN Cell	89
4.18.4	Maximum Received Total Wideband Power of an UTRAN Cell.....	89
4.18.5	Mean Radio Link Transmitted Code Power of an UTRAN Cell	89
4.18.6	Maximum Radio Link Transmitted Code Power of an UTRAN Cell.....	90
4.18.7	Mean transmitted carrier power of all codes not used for HS-PDSCH, HS-SCCH, E-AGCH, E- RGCH or E-HICH transmission of an UTRAN Cell	90
4.18.8	Maximum transmitted carrier power of all codes not used for HS-PDSCH, HS-SCCH, E-AGCH, E- RGCH or E-HICH transmission of an UTRAN Cell	90
4.19	FDD Code Resources	91
4.19.1	Code Resources Used of an FDD mode UTRAN Cell	91
4.20	Paging.....	91
4.20.1	Overview	91
4.20.1.1	Considered Paging procedures	91
4.20.2	Paging request from CN	92
4.20.3	Paging Type 1	93
4.20.3.1	Attempted Paging Type 1.....	93
4.20.4	Paging Type 2	93
4.20.4.1	Attempted Paging Type 2.....	93
4.21	ATM layer measurement.....	94
4.21.1	Cell collection.....	94
4.21.1.1	Ingress cells (whole stream).....	94
4.21.1.2	Egress cells (whole stream).....	94
4.22	HSDPA setup	94
4.22.1	Mac-d setup for HSDPA.....	94
4.22.1.1	Attempted Mac-d setups for HSDPA.....	94
4.22.1.2	Successful Mac-d setups for HSDPA.....	95
4.22.1.3	Failed Mac-d setups for HSDPA.....	95
4.22.2	RB setup for HSDPA	96
4.22.2.1	Attempted RB setups for HSDPA.....	96
4.22.2.2	Successful RB setups for HSDPA.....	96
4.22.2.3	Failed RB setups for HSDPA.....	97
4.23	Call duration in UTRAN cell	97
4.23.1	Call duration in UTRAN cell for CS domain	97
4.24	Measurements related to channel switches between FACH/DCH and HS-DSCH.....	98
4.24.1	Measurements related to channel switches from FACH/DCH to HS-DSCH intra UTRAN cell.....	98
4.24.1.1	Attempted channel switches from FACH to HS-DSCH	98
4.24.1.2	Successful channel switches from FACH to HS-DSCH	99
4.24.1.3	Attempted channel switches from DCH to HS-DSCH.....	99
4.24.1.4	Successful channel switches from DCH to HS-DSCH	99
4.24.2	Measurements related to channel switches from HS-DSCH to FACH/DCH intra UTRAN cell.....	100
4.24.2.1	Attempted channel switches from HS-DSCH to FACH	100
4.24.2.2	Successful channel switches from HS-DSCH to FACH	100
4.24.2.3	Attempted channel switches from HS-DSCH to DCH.....	101
4.24.2.4	Successful channel switches from HS-DSCH to DCH	101
4.25	HSDPA mobility related measurements.....	101
4.25.1	Serving HS-DSCH cell change.....	101
4.25.1.1	Attempted serving HS-DSCH cell changes.....	101
4.25.1.2	Successful serving HS-DSCH cell changes	102
4.26	Measurements related to MAC-hs.....	102
4.26.1	Measurements related to MAC-hs feedback decoding	102
4.26.1.1	Number of acknowledged transmitted MAC-hs PDUs	102
4.26.1.2	Number of transmitted MAC-hs PDUs.....	102
4.27	Mean number of HSDPA users in a serving HS-DSCH cell	103
4.28	Number of octets of acknowledged MAC-hs PDUs.....	103
4.29	Number of TTIs with user data packets in buffer	103
4.30	HSDPA Release measurements.....	104

4.30.1	Overview of HSDPA Release	104
4.30.1.1	General	104
4.30.1.2	Considered RRC procedures	104
4.30.1.3	Considered RANAP protocol procedures	107
4.30.2	Normal HSDPA Release.....	108
4.30.2.1	RNC Initiated Release due to user inactivity	108
4.30.2.2	Switch to DCH/FACH	108
4.30.2.3	HS-DSCH serving cell change	108
4.30.2.4	CN Initiated release	108
4.30.3	Abnormal RB releases for HS-DSCH.....	109
4.31	RRC Connection mobility	109
4.31.1	Cell update	109
4.31.1.1	Attempted cell update	109
4.32	Measurements related to received uplink transport block	110
4.32.1	Measurements related to received uplink transport block for CS domain	110
4.32.1.1	Number of received uplink transport blocks of DCH for CS domain	110
4.32.1.2	Number of received uplink faulty transport blocks of DCH for CS domain	110
4.32.2	Measurements related to received uplink transport block for PS domain.....	111
4.32.2.1	Number of received uplink transport blocks of DCH for PS domain.....	111
4.32.2.2	Number of received uplink faulty transport blocks of DCH for PS domain	111
Annex A (informative): Change history		113
History		114

Foreword

This Technical Specification has been produced by the 3rd Generation Partnership Project (3GPP).

The contents of the present document are subject to continuing work within the TSG and may change following formal TSG approval. Should the TSG modify the contents of the present document, it will be re-released by the TSG with an identifying change of release date and an increase in version number as follows:

Version x.y.z

where:

- x the first digit:
 - 1 presented to TSG for information;
 - 2 presented to TSG for approval;
 - 3 or greater indicates TSG approved document under change control.
- y the second digit is incremented for all changes of substance, i.e. technical enhancements, corrections, updates, etc.
- z the third digit is incremented when editorial only changes have been incorporated in the document.

Introduction

The present document is part of a TS-family covering the 3rd Generation Partnership Project; Technical Specification Group Services and System Aspects; Telecommunication management; as identified below:

32.401	Performance Management (PM); Concept and requirements
52.402	Performance Management (PM); Performance measurements – GSM
32.404	Performance Management (PM); Performance measurements - Definitions and template
32.405	Performance Management (PM); Performance measurements Universal Terrestrial Radio Access Network (UTRAN)
32.406	Performance Management (PM); Performance measurements Core Network (CN) Packet Switched (PS) domain
32.407	Performance Management (PM); Performance measurements Core Network (CN) Circuit Switched (CS) domain
32.408	Performance Management (PM); Performance measurements Teleservice
32.409	Performance Management (PM); Performance measurements IP Multimedia Subsystem (IMS)

The present document is part of a set of specifications, which describe the requirements and information model necessary for the standardised Operation, Administration and Maintenance (OA&M) of a multi-vendor 3G-system.

During the lifetime of a 3G network, its logical and physical configuration will undergo changes of varying degrees and frequencies in order to optimise the utilisation of the network resources. These changes will be executed through network configuration management activities and/or network engineering, see TS 32.600 [3].

Many of the activities involved in the daily operation and future network planning of a 3G network require data on which to base decisions. This data refers to the load carried by the network and the grade of service offered. In order to produce this data performance measurements are executed in the NEs, which comprise the network. The data can then be transferred to an external system, e.g. an Operations System (OS) in TMN terminology, for further evaluation. The purpose of the present document is to describe the mechanisms involved in the collection of the data and the definition of the data itself.

Annex B of TS 32.404 helps in the definition of new performance measurements that can be submitted to 3GPP for potential adoption and inclusion in the present document. Annex B of TS 32.404 discusses a top-down performance measurement definition methodology that focuses on how the end-user of performance measurements can use the measurements..

1 Scope

The present document describes the measurements for UMTS and combined UMTS/GSM.

TS 32.401 [1] describes Performance Management concepts and requirements.

The present document is valid for all measurement types provided by an implementation of a UMTS network and combined UMTS/GSM network.

Only measurement types that are specific to UMTS or combined UMTS/GSM networks are defined within the present documents. Vendor specific measurement types used in UMTS and combined UMTS/GSM networks are not covered. Instead, these could be applied according to manufacturer's documentation.

Measurements related to "external" technologies (such as ATM or IP) as described by "external" standards bodies (e.g. ITU-T or IETF) shall only be referenced within this specification, wherever there is a need identified for the existence of such a reference.

The definition of the standard measurements is intended to result in comparability of measurement data produced in a multi-vendor network, for those measurement types that can be standardised across all vendors' implementations.

The structure of the present document is as follows:

- Header 1: Network Element (e.g. RNC related measurements);
- Header 2: Measurement function (e.g. soft handover measurements);
- Header 3: Measurements.

2 References

The following documents contain provisions which, through reference in this text, constitute provisions of the present document.

- References are either specific (identified by date of publication and/or edition number or version number) or non-specific.
- For a specific reference, subsequent revisions do not apply.
- For a non-specific reference, the latest version applies. In the case of a reference to a 3GPP document (including a GSM document), a non-specific reference implicitly refers to the latest version of that document *in the same Release as the present document*.

- [1] 3GPP TS 32.401: "Telecommunication management; Performance Management (PM); Concept and requirements".
- [2] 3GPP TS 23.107: "Quality of Service (QoS) concept and architecture".
- [3] 3GPP TS 32.600: "Telecommunication management; Configuration Management (CM); Concept and high-level requirements".
- [4] 3GPP TS 25.331: "Radio Resource Control (RRC) protocol specification".
- [5] 3GPP TS 25.413: "UTRAN Iu Interface RANAP signalling".
- [6] 3GPP TS 25.423: "UTRAN Iur Interface RNSAP signalling".
- [7] 3GPP TS 25.433: "UTRAN Iub Interface NBAP signalling".
- [8] 3GPP TS 25.133: "Requirements for support of radio resource management (FDD)".
- [9] 3GPP TS 25.123: "Requirements for support of radio resource management (TDD)".

- [10] 3GPP TS 25.322: "Radio Link Control (RLC) protocol specification".
- [11] af-nm-0185.000, "M4 Interface ATM Network View CORBA MIB".
- [12] 3GPP TS 32.432: "Telecommunication management; Performance measurement: File format definition".
- [13] 3GPP TS 25.993: "Typical examples of Radio Access Bearers (RABs) and Radio Bearers (RBs) supported by Universal Terrestrial Radio Access (UTRA)".
- [14] 3GPP TS 25.215: "Physical layer – Measurements (FDD)".
- [15] 3GPP TS 32.432: "Telecommunication management; Performance measurement: File format definition".
- [16] 3GPP TS 25.225: "Physical layer – Measurements (TDD)".
- [17] 3GPP TS 25.427: "UTRAN Iub/Iur interface user plane protocol for DCH data streams".

3 Measurement family and abbreviations

3.1 Measurement family

The measurement names defined in the present document are all beginning with a prefix containing the measurement family name (e.g. RAB.AttEstabCS.Conv). This family name identifies all measurements which relate to a given functionality and it may be used for measurement administration (see TS 32.401 [1]).

The list of families currently used in the present document is as follows:

- ATML (measurements related to ATM Layer)
- CARR (measurements related to UTRAN cell Radio Frequency carrier)
- CR (measurements related to Code Resources)
- DCA (measurements related to Dynamic Channel Allocation)
- FP (measurements related to Frame Protocol)
- HHO (measurements related to Hard Handover)
- HSDPA (measurements related to High Speed Downlink Packet Access)
- IRATHO (measurements related to inter-Radio Access Technology Handover)
- IU (measurements related to Iu connection)
- RAB (measurements related to Radio Access Bearer management)
- RELOC (measurements related to SRNS Relocation)
- RLC (measurements related to Radio Link Control)
- RLM (measurements related to Radio Link Management)
- RRC (measurements related to Radio Resource Control)
- SHO (measurements related to Soft Handover)
- SIG (measurements related to Signalling)
- TCR (measurements related to TDD Code Resources)

3.2 Abbreviations

For the purposes of the present document, the following abbreviations apply:

ASN.1	Abstract Syntax Notation 1
BER	Basic Encoding Rules
CN	Core Network
DTD	Document Type Definition
EGQM	Enhanced Goal, Question, Metric
EM	(Network) Element Manager
GQM	Goal, Question, Metric
HSDPA	High Speed Downlink Packet Access
Iu	Interface
MSC	Mobile services Switching Centre

NE	Network Element
NM	Network Manager
OA&M	Operation, Administration and Maintenance
OS	Operations System (EM, NM)
OSI	Open Systems Interconnection
PM	Performance Management
QoS	Quality of Service
RNC	Radio Network Controller
UMTS	Universal Mobile Telecommunications System
UTRAN	Universal Terrestrial Radio Access Network

You can find below a list of abbreviations used within the measurement types for field E of the measurement template.

Ackd	Acknowledged
Assn	Assign(ment,ed)
Att	Attempt(s,ed)
Bgrd	Background
Call	Call
Chg	Change
Conn	Connection
Combi	Combined
CS	Circuit switched
Ctrl	Controlled
Conv	Conversational
Del	Deletion
Drop	Drop(ped)
Estab	Establish (ed,ment)
Fail	Fail(ed, ure)
FDD	Frequency Division Duplex
FP	Frame Protocol
HHO	Hard Handover
HO	Handover
Inc	Incoming
Intact	Interactive
Inter	Inter
Intra	Intra
Invol	Involve(d)
ISCP	Interference Signal Code Power
Max	Maximum
Nat	National
Netw	Network
NodeB	NodeB
Oct	Octet(s)
Oth	Other
Out	Outgoing
Pkt	Packet(s)
Prep	Preparation
Proc	Procedure
PS	Packet switched
RAB	Radio Access Bearer
RAT	Radio Access Technology
RB	Radio Bearer
ReEstab	Re-establish (ed,ment)
Rel	Released
Reloc	Relocation
Req	Request(s,ed)
Res	Resource
RL	Radio Link
RNC	RNC
RRC	Radio Resource Control
RTWP	Received Total Wideband Power
Setup	Setup

SGSN	SGSN
SHO	Soft Handover
Sig	Signalling
Strm	Streaming
Sub	Subscriber
Succ	Success(es,ful)
TCP	Transmitted Carrier Power
UE	User Equipment
UTRAN	UTRAN

4 Measurements related to the RNC

4.1 RAB management

4.1.1 Overview

4.1.1.1 Measurements are based on the success and failure of procedures

The proposed measurements are not merely based on the counting of a given type of message since a same message may be repeated by an implementation dependent process. The aim here is to provide implementation independent specification.

Proposed measurements are based on the success/failure of procedures identified in the reference documents. The end of a procedure implies a stable state of the communication between the two involved parties. This stable state is normally the object of a common understanding from the two parties. As a consequence, proposed measurements are attached either to the successful or the unsuccessful issue of a procedure.

4.1.1.2 Combination of Traffic Class and Core Network domains

A Radio Access Bearer (RAB) is characterized by several QOS parameters among them is the Traffic Class. Currently there are not any 3GPP specifications including TS 23.107 [2] in which may be found restrictions related to the possible combinations between Traffic Class and Core Network domain.

Consequently, as a conservative position, this specification should leave open every possible combination between Traffic Class and Core Network domain as specification TS 23.107 [2] does.

4.1.1.3 Considered Radio Access Bearer management procedures

Performance Measurement definitions in this subclause are based on TS 25.413 [5].

The following paragraphs are of interest for this purpose:

- RAB Assignment;
- RAB Release Request;
- RAB ASSIGNMENT REQUEST;
- RAB ASSIGNMENT RESPONSE;
- RAB RELEASE REQUEST.

These paragraphs show in particular the following diagrams.

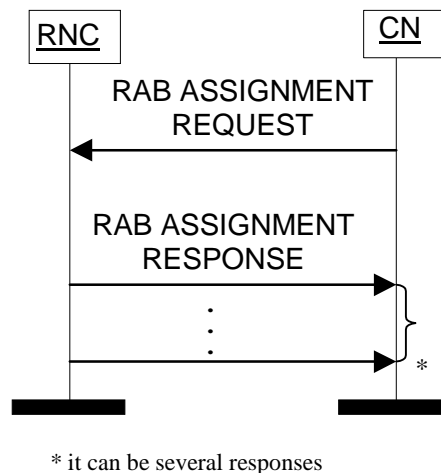

Figure: RAB Assignment procedure. Successful operation

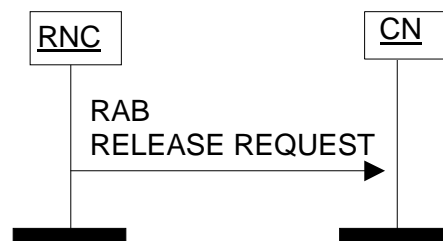

Figure: RAB Release Request procedure

4.1.1.4 Measurements relate to RAB establishment, modification and release

RAB management procedure includes RAB Assignment procedure and RAB Release Request procedure. The purpose of RAB Assignment procedure is to establish new RABs and/or to enable modifications and/or releases of already established RABs for a given UE. If RABs are failed to be established or modified, the involved services may fail. RAB release request can be initiated by CN or RNC when the services terminate normally or abnormally.

During daily maintenance of network, measurements regarding RAB establishment, modification and release are useful for operators to evaluate RAB management procedures, to analyze failure reasons of RAB establishment and RAB modification, and to analyze the causes of RAB release, especially in case RAB release abnormally.

4.1.2 RAB establishment for CS domain

The five measurement types defined in the clause 4.1.2 for CS domain are subject to the "4 out of 5 approach".

4.1.2.1 Attempted RAB establishments for CS domain

- a) This measurement provides the number of requested RAB in establishment attempts for CS domain. The measurement is split into subcounters per traffic class.
- b) CC
- c) On receipt by the RNC of a RANAP RAB ASSIGNMENT REQUEST message for CS domain, each requested RAB in establishment attempts is added to the relevant measurement according to the traffic class requested. See TS 25.413 [5] and TS 23.107 [2]. For conversational service, the relevant measurement according to the data rates requested, see TS 25.993 [13] as follows:
 - uplink<U>:
 - 1: AMR rate (12.2 10.2 7.95 7.4 6.7 5.9 5.15 4.75) kbps
 - 2: 12.2 kbps

- 3: 28.8 kbps
- 4: 32 kbps
- 5: 64 kbps

downlink<D>:

- 1: AMR rate (12.2 10.2 7.95 7.4 6.7 5.9 5.15 4.75) kbps
- 2: 12.2 kbps
- 3: 28.8 kbps
- 4: 32 kbps
- 5: 64 kbps

As indicated above, <U> and <D> are integer values that map to the conversational service specified uplink and downlink data rates respectively.

NOTE : The addition is performed with the condition that the RAB has not been setup or modified successfully in a previous RANAP RAB ASSIGNMENT RESPONSE or RELOCATION REQUEST ACKNOWLEDGE.

- d) Each measurement is an integer value.
- e) RAB.AttEstabCS.Conv.<U><D>
RAB.AttEstabCS.Strm
RAB.AttEstabCS.Intact
RAB.AttEstabCS.Bgrd
- f) RncFunction
- g) Valid for circuit switched traffic
- h) UMTS

4.1.2.2 Successful RAB establishments without queuing for CS domain

- a) This measurement provides the number of successfully established RABs for CS domain in which a queuing process has not been involved. The measurement is split into subcounters per traffic class.
- b) CC
- c) On transmission by the RNC of a RANAP RAB ASSIGNMENT RESPONSE message for CS domain, each successfully established RAB is added to the relevant measurement according to the traffic class requested in the RAB ASSIGNMENT REQUEST message. See TS 25.413 [5] and TS 23.107 [2]. For conversational service, the relevant measurement according to the data rates requested, see TS 25.993 [13] as follows:

uplink<U>:

- 1: AMR rate (12.2 10.2 7.95 7.4 6.7 5.9 5.15 4.75) kbps
- 2: 12.2 kbps
- 3: 28.8 kbps
- 4: 32 kbps
- 5: 64 kbps

downlink<D>:

- 1: AMR rate (12.2 10.2 7.95 7.4 6.7 5.9 5.15 4.75) kbps
- 2: 12.2 kbps
- 3: 28.8 kbps
- 4: 32 kbps
- 5: 64 kbps

As indicated above, <U> and <D> are integer values that map to the conversational service specified uplink and downlink data rates respectively.

NOTE: The addition is performed with the condition that the RAB has not been mentioned as queued in a previous RANAP RAB ASSIGNMENT RESPONSE and the RAB has not been setup or modified successfully in a previous RANAP RAB ASSIGNMENT RESPONSE or RELOCATION REQUEST ACKNOWLEDGE.

- d) Each measurement is an integer value.
- e) RAB.SuccEstabCSNoQueuing.Conv.<U><D>
RAB.SuccEstabCSNoQueuing.Strm

RAB.SuccEstabCSNoQueuing.Intact
 RAB.SuccEstabCSNoQueuing.Bgrd.

- f) RncFunction
- g) Valid for circuit switched traffic
- h) UMTS

4.1.2.3 Failed RAB establishments without queuing for CS domain

- a) This measurement provides the number of RABs failed to establish for CS domain in which a queuing process has not been involved. The measurement is split into subcounters per failure cause.
- b) CC
- c) On transmission by the RNC of a RANAP RAB ASSIGNMENT RESPONSE message for CS domain, each RAB failed to establish is added to the relevant measurement according to the failure cause. Possible causes are included in TS 25.413 [5]. The sum of all supported per cause measurements shall equal the total number of RAB Establishment Failures. In case only a subset of per cause measurements is supported, a sum subcounter will be provided first.

NOTE: The addition is performed with the condition that the RAB has not been mentioned as queued in a previous RANAP RAB ASSIGNMENT RESPONSE and the RAB has not been setup or modified successfully in a previous RANAP RAB ASSIGNMENT RESPONSE or RELOCATION REQUEST ACKNOWLEDGE.

- d) Each measurement is an integer value. The number of measurements is equal to the number of causes supported plus a possible sum value identified by the *.sum* suffix.
- e) The measurement name has the form RAB.FailEstabCSNoQueuing.*Cause* where *Cause* identifies the failure cause.
- f) RncFunction
- g) Valid for circuit switched traffic
- h) UMTS

4.1.2.4 Successful RAB establishments with queuing for CS domain

- a) This measurement provides the number of successfully established RABs for CS domain in which a queuing process has been involved. The measurement is split into subcounters per traffic class.
- b) CC
- c) On transmission by the RNC of a RANAP RAB ASSIGNMENT RESPONSE message for CS domain, each successfully established RAB is added to the relevant measurement according to the traffic class. See TS 25.413 [5] and TS 23.107 [2]. For conversational service, the relevant measurement according to the data rates requested, see TS 25.993 [13] as follows:

uplink<U>:

- 1: AMR rate (12.2 10.2 7.95 7.4 6.7 5.9 5.15 4.75) kbps
- 2: 12.2 kbps
- 3: 28.8 kbps
- 4: 32 kbps
- 5: 64 kbps

downlink<D>:

- 1: AMR rate (12.2 10.2 7.95 7.4 6.7 5.9 5.15 4.75) kbps
- 2: 12.2 kbps
- 3: 28.8 kbps
- 4: 32 kbps
- 5: 64 kbps

As indicated above, <U> and <D> are integer values that map to the conversational service specified uplink and downlink data rates respectively.

NOTE: The addition is performed with the condition that the RAB has been mentioned as queued in a previous RANAP RAB ASSIGNMENT RESPONSE and the RAB has not been setup or modified successfully in a previous RANAP RAB ASSIGNMENT RESPONSE or RELOCATION REQUEST ACKNOWLEDGE.

- d) Each measurement is an integer value.
- e) RAB.SuccEstabCSQueuing.Conv.<U><D>
RAB.SuccEstabCSQueuing.Strm
RAB.SuccEstabCSQueuing.Intact
RAB.SuccEstabCSQueuing.Bgrd
- f) RncFunction
- g) Valid for circuit switched traffic
- h) UMTS

4.1.2.5 Failed RAB establishments with queuing for CS domain

- a) This measurement provides the number of RABs failed to establish for CS domain in which a queuing process has been involved. The measurement is split into subcounters per failure cause.
- b) CC
- c) On transmission by the RNC of a RANAP RAB ASSIGNMENT RESPONSE message for CS domain, each RAB failed to establish is added to the relevant measurement according to the cause. Possible causes are included in TS 25.413 [5]. The sum of all supported per cause measurements shall equal the total number of RAB Establishment Failures. In case only a subset of per cause measurements is supported, a sum subcounter will be provided first.

NOTE: The addition is performed with the condition that the RAB has been mentioned as queued in a previous RANAP RAB ASSIGNMENT RESPONSE and the RAB has not been setup or modified successfully in a previous RANAP RAB ASSIGNMENT RESPONSE or RELOCATION REQUEST ACKNOWLEDGE.

- d) Each measurement is an integer value. The number of measurements is equal to the number of causes plus a possible sum value identified by the *.sum* suffix.
- e) The measurement name has the form RAB.FailEstabCSQueuing.*Cause* where *Cause* identifies the failure cause.
- f) RncFunction
- g) Valid for circuit switched traffic
- h) UMTS

4.1.3 RAB establishment for PS domain

The five measurement types defined in the clause 4.1.3 for PS domain are subject to the "4 out of 5 approach".

4.1.3.1 Attempted RAB establishments for PS domain

- a) This measurement provides the number of requested RABs in establishment attempts for PS domain. The measurement is split into subcounters per traffic class.
- b) CC
- c) On receipt by the RNC of a RANAP RAB ASSIGNMENT REQUEST message for PS domain, each requested RAB in establishment attempts is added to the relevant measurement according to the traffic class requested. See TS 25.413 [5] and TS 23.107 [2].

NOTE: The addition is performed with the condition that the RAB has not been setup or modified successfully in a previous RANAP RAB ASSIGNMENT RESPONSE or RELOCATION REQUEST ACKNOWLEDGE.

- d) Four integer values.
- e) RAB.AttEstabPS.Conv
RAB.AttEstabPS.Strm
RAB.AttEstabPS.Intact
RAB.AttEstabPS.Bgrd
- f) RncFunction
- g) Valid for packet switched traffic.
- h) UMTS

4.1.3.2 Successful RAB establishments without queuing for PS domain

- a) This measurement provides the number of successfully established RABs for PS domain in which a queuing process has not been involved. The measurement is split into subcounters per traffic class.
- b) CC
- c) On transmission by the RNC of a RANAP RAB ASSIGNMENT RESPONSE message for PS domain, each successfully established RAB is added to the relevant measurement according to the traffic class. See TS 25.413 [5] and TS 23.107 [2].

NOTE: The addition is performed with the condition that the RAB has not been mentioned as queued in a previous RANAP RAB ASSIGNMENT RESPONSE and the RAB has not been setup or modified successfully in a previous RANAP RAB ASSIGNMENT RESPONSE or RELOCATION REQUEST ACKNOWLEDGE.

- d) Four integer values.
- e) RAB.SuccEstabPSNoQueuing.Conv
RAB.SuccEstabPSNoQueuing.Strm
RAB.SuccEstabPSNoQueuing.Intact
RAB.SuccEstabPSNoQueuing.Bgrd
- f) RncFunction
- g) Valid for packet switched traffic.
- h) UMTS

4.1.3.3 Failed RAB establishments without queuing for PS domain

- a) This measurement provides the number of RABs failed to establish for PS in which a queuing process has not been involved. The measurement is split into subcounters per failure cause.
- b) CC
- c) On transmission by the RNC of a RANAP RAB ASSIGNMENT RESPONSE message for PS domain, each RAB failed to establish is added to the relevant measurement according to the failure cause. Possible causes are included in TS 25.413 [5]. The sum of all supported per cause measurements shall equal the total number of RAB Establishment Failures. In case only a subset of per cause measurements is supported, a sum subcounter will be provided first.

NOTE: The addition is performed with the condition that the RAB has not been mentioned as queued in a previous RANAP RAB ASSIGNMENT RESPONSE and the RAB has not been setup or modified successfully in a previous RANAP RAB ASSIGNMENT RESPONSE or RELOCATION REQUEST ACKNOWLEDGE.

- d) Each measurement is an integer value. The number of measurements is equal to the number of causes plus a possible sum value identified by the *.sum* suffix.
- e) The measurement name has the form RAB.FailEstabPSNoQueuing.*Cause* where *Cause* identifies the failure cause.
- f) RncFunction
- g) Valid for packet switched traffic.
- h) UMTS

4.1.3.4 Successful RAB establishments with queuing for PS domain

- a) This measurement provides the number of successfully established RABs for PS domain in which a queuing process has been involved. The measurement is split into subcounters per traffic class.
- b) CC
- c) On transmission by the RNC of a RANAP RAB ASSIGNMENT RESPONSE message for PS domain, each successfully established RAB is added to the relevant measurement according to the traffic class. See TS 25.413 [5] and TS 23.107 [2].

NOTE: The addition is performed with the condition that the RAB has been mentioned as queued in a previous RANAP RAB ASSIGNMENT RESPONSE and the RAB has not been setup or modified successfully in a previous RANAP RAB ASSIGNMENT RESPONSE or RELOCATION REQUEST ACKNOWLEDGE.

- d) Four integer values.
- e) RAB.SuccEstabPSQueuing.Conv
RAB.SuccEstabPSQueuing.Strm
RAB.SuccEstabPSQueuing.Intact
RAB.SuccEstabPSQueuing.Bgrd
- f) RncFunction
- g) Valid for packet switched traffic.
- h) UMTS

4.1.3.5 Failed RAB establishments with queuing for PS domain

- a) This measurement provides the number of RABs failed to establish for PS domain in which a queuing process has been involved. The measurement is split into subcounters per failure cause.
- b) CC
- c) On transmission by the RNC of a RANAP RAB ASSIGNMENT RESPONSE message for PS domain, each RAB failed to establish is added to the relevant measurement according to the cause. Possible causes are included in TS 25.413 [5]. The sum of all supported per cause measurements shall equal the total number of RAB Establishment Failures. In case only a subset of per cause measurements is supported, a sum subcounter will be provided first.

NOTE: The addition is performed with the condition that the RAB has been mentioned as queued in a previous RANAP RAB ASSIGNMENT RESPONSE and the RAB has not been setup or modified successfully in a previous RANAP RAB ASSIGNMENT RESPONSE or RELOCATION REQUEST ACKNOWLEDGE.

- d) Each measurement is an integer value. The number of measurements is equal to the number of causes plus a possible sum value identified by the *.sum* suffix.
- e) The measurement name has the form RAB.FailEstabPSQueuing.*Cause* where *Cause* identifies the failure cause.

- f) RncFunction
- g) Valid for packet switched traffic.
- h) UMTS

4.1.4 RAB modification for CS domain

The five measurement types defined in the clause 4.1.4 for CS domain are subject to the "4 out of 5 approach".

4.1.4.1 Attempted RAB modifications for CS domain

- a) This measurement provides the number of requested RABs in modification attempts for CS domain. The measurement is split into subcounters per traffic class.
- b) CC
- c) On receipt by the RNC of a RANAP RAB ASSIGNMENT REQUEST message for CS domain, each requested RAB in modification attempts is added to the relevant measurement according to the traffic class requested. See TS 25.413 and TS 23.107.

NOTE: The addition is performed with the condition that the RAB has been setup or modified successfully in a previous RANAP RAB ASSIGNMENT RESPONSE or RELOCATION REQUEST ACKNOWLEDGE.

- d) Four integer values.
- e) RAB.AttModCS.Conv
RAB.AttModCS.Strm
RAB.AttModCS.Intact
RAB.AttModCS.Bgrd
- f) RncFunction
- g) Valid for circuit switched traffic
- h) UMTS

4.1.4.2 Successful RAB modifications without queuing for CS domain

- a) This measurement provides the number of successfully modified RABs for CS domain in which a queuing process has not been involved. The measurement is split into subcounters per traffic class.
- b) CC
- c) On transmission by the RNC of a RANAP RAB ASSIGNMENT RESPONSE message for CS domain, each successfully modified RAB is added to the relevant measurement according to the traffic class requested in the RAB ASSIGNMENT REQUEST message. See TS 25.413 [5] and TS 23.107 [2].

NOTE: The addition is performed with the condition that the RAB has not been mentioned as queued in a previous RANAP RAB ASSIGNMENT RESPONSE and the RAB has been setup or modified successfully in a previous RANAP RAB ASSIGNMENT RESPONSE or RELOCATION REQUEST ACKNOWLEDGE.

- d) Four integer values.
- e) RAB.SuccModCSNoQueuing.Conv
RAB.SuccModCSNoQueuing.Strm
RAB.SuccModCSNoQueuing.Intact
RAB.SuccModCSNoQueuing.Bgrd
- f) RncFunction
- g) Valid for circuit switched traffic

h) UMTS

4.1.4.3 Failed RAB modifications without queuing for CS domain

- a) This measurement provides the number of RABs failed to modify for CS domain in which a queuing process has not been involved. The measurement is split into subcounters per failure cause.
- b) CC
- c) On transmission by the RNC of a RANAP RAB ASSIGNMENT RESPONSE message for CS domain, each RAB failed to modify is added to the relevant measurement according to the failure cause. Possible causes are included in TS 25.413 [5]. The sum of all supported per cause measurements shall equal the total number of RAB Modification Failures. In case only a subset of per cause measurements is supported, a sum measurement subtype will be provided first.

NOTE: The addition is performed with the condition that the RAB has not been mentioned as queued in a previous RANAP RAB ASSIGNMENT RESPONSE and the RAB has been setup or modified successfully in a previous RANAP RAB ASSIGNMENT RESPONSE or RELOCATION REQUEST ACKNOWLEDGE.

- d) Each measurement is an integer value. The number of measurements is equal to the number of causes supported plus a possible sum value identified by the *.sum* suffix.
- e) The measurement name has the form RAB.FailModCSNoQueuing.*Cause* where *Cause* identifies the failure cause.
- f) RncFunction
- g) Valid for circuit switched traffic
- h) UMTS

4.1.4.4 Successful RAB modifications with queuing for CS domain

- a) This measurement provides the number of successfully modified RABs for CS domain in which a queuing process has been involved. The measurement is split into subcounters per traffic class.
- b) CC
- c) On transmission by the RNC of a RANAP RAB ASSIGNMENT RESPONSE message for CS domain, each successfully modified RAB is added to the relevant measurement according to the traffic class. See TS 25.413 [5] and TS 23.107 [2].

NOTE: The addition is performed with the condition that the RAB has been mentioned as queued in a previous RANAP RAB ASSIGNMENT RESPONSE and the RAB has been setup or modified successfully in a previous RANAP RAB ASSIGNMENT RESPONSE or RELOCATION REQUEST ACKNOWLEDGE.

- d) Four integer values.
- e) RAB.SuccModCSQueuing.Conv
RAB.SuccModCSQueuing.Strm
RAB.SuccModCSQueuing.Intact
RAB.SuccModCSQueuing.Bgrd
- f) RncFunction
- g) Valid for circuit switched traffic
- h) UMTS

4.1.4.5 Failed RAB modifications with queuing for CS domain

- a) This measurement provides the number of RABs failed to modify for CS domain in which a queuing process has been involved. The measurement is split into subcounters per failure cause.

- b) CC
 - c) On transmission by the RNC of a RANAP RAB ASSIGNMENT RESPONSE message for CS domain, each RAB failed to modify is added to the relevant measurement according to the cause. Possible causes are included in TS 25.413 [5]. The sum of all supported per cause measurements shall equal the total number of RAB Modification Failures. In case only a subset of per cause measurements is supported, a sum measurement subtype will be provided first.
- NOTE: The addition is performed with the condition that the RAB has been mentioned as queued in a previous RANAP RAB ASSIGNMENT RESPONSE and the RAB has been setup or modified successfully in a previous RANAP RAB ASSIGNMENT RESPONSE or RELOCATION REQUEST ACKNOWLEDGE.
- d) Each measurement is an integer value. The number of measurements is equal to the number of causes plus a possible sum value identified by the *.sum* suffix.
 - e) The measurement name has the form RAB.FailModCSQueuing.*Cause* where *Cause* identifies the failure cause.
 - f) RncFunction
 - g) Valid for circuit switched traffic
 - h) UMTS

4.1.5 RAB modification for PS domain

The five measurement types defined in the clause 4.1.5 for PS domain are subject to the "4 out of 5 approach".

4.1.5.1 Attempted RAB modifications for PS domain

- a) This measurement provides the number of requested RABs in modification attempts for PS domain. The measurement is split into subcounters per traffic class.
 - b) CC
 - c) On receipt by the RNC of a RANAP RAB ASSIGNMENT REQUEST message for PS domain, each requested RAB in modification attempts is added to the relevant measurement according to the traffic class requested. See TS 25.413 [5] and TS 23.107 [2].
- NOTE: The addition is performed with the condition that the RAB has been setup or modified successfully in a previous RANAP RAB ASSIGNMENT RESPONSE or RELOCATION REQUEST ACKNOWLEDGE.
- d) Four integer values.
 - e) RAB.AttModPS.Conv
RAB.AttModPS.Strm
RAB.AttModPS.Intact
RAB.AttModPS.Bgrd.
 - f) RncFunction
 - g) Valid for packet switched traffic.
 - h) UMTS

4.1.5.2 Successful RAB modifications without queuing for PS domain

- a) This measurement provides the number of successfully modified RABs for PS domain in which a queuing process has not been involved. The measurement is split into subcounters per traffic class.
- b) CC

- c) On transmission by the RNC of a RANAP RAB ASSIGNMENT RESPONSE message for PS domain, each successfully modified RAB is added to the relevant measurement according to the traffic class. See TS 25.413 [5] and TS 23.107 [2].

NOTE: The addition is performed with the condition that the RAB has not been mentioned as queued in a previous RANAP RAB ASSIGNMENT RESPONSE and the RAB has been setup or modified successfully in a previous RANAP RAB ASSIGNMENT RESPONSE or RELOCATION REQUEST ACKNOWLEDGE.

- d) Four integer values.
- e) RAB.SuccModPSNoQueuing.Conv
RAB.SuccModPSNoQueuing.Strm
RAB.SuccModPSNoQueuing.Intact
RAB.SuccModPSNoQueuing.Bgrd.
- f) RncFunction
- g) Valid for packet switched traffic.
- h) UMTS

4.1.5.3 Failed RAB modifications without queuing for PS domain

- a) This measurement provides the number of RABs failed to modify for PS in which a queuing process has not been involved. The measurement is split into subcounters per failure cause.
- b) CC
- c) On transmission by the RNC of a RANAP RAB ASSIGNMENT RESPONSE message for PS domain, each RAB failed to modify is added to the relevant measurement according to the failure cause. Possible causes are included in TS 25.413 [5]. The sum of all supported per cause measurements shall equal the total number of RAB Modification Failures. In case only a subset of per cause measurements is supported, a sum measurement subtype will be provided first.

NOTE: The addition is performed with the condition that the RAB has not been mentioned as queued in a previous RANAP RAB ASSIGNMENT RESPONSE and the RAB has been setup or modified successfully in a previous RANAP RAB ASSIGNMENT RESPONSE or RELOCATION REQUEST ACKNOWLEDGE.

- d) Each measurement is an integer value. The number of measurements is equal to the number of causes plus a possible sum value identified by the *.sum* suffix.
- e) The measurement name has the form RAB.FailModPSNoQueuing.*Cause* where *Cause* identifies the failure cause.
- f) RncFunction
- g) Valid for packet switched traffic.
- h) UMTS

4.1.5.4 Successful RAB modifications with queuing for PS domain

- a) This measurement provides the number of successfully modified RABs for PS domain in which a queuing process has been involved. The measurement is split into subcounters per traffic class.
- b) CC
- c) On transmission by the RNC of a RANAP RAB ASSIGNMENT RESPONSE message for PS domain, each successfully modified RAB is added to the relevant measurement according to the traffic class. See TS 25.413 [5] and TS 23.107 [2].

NOTE: The addition is performed with the condition that the RAB has been mentioned as queued in a previous RANAP RAB ASSIGNMENT RESPONSE and the RAB has been setup or modified successfully in a previous RANAP RAB ASSIGNMENT RESPONSE or RELOCATION REQUEST ACKNOWLEDGE.

- d) Four integer values.
- e) RAB.SuccModPSQueuing.Conv
RAB.SuccModPSQueuing.Strm
RAB.SuccModPSQueuing.Intact
RAB.SuccModPSQueuing.Bgrd.
- f) RncFunction
- g) Valid for packet switched traffic.
- h) UMTS

4.1.5.5 Failed RAB modifications with queuing for PS domain

- a) This measurement provides the number of RABs failed to modify for PS domain in which a queuing process has been involved. The measurement is split into subcounters per failure cause.
- b) CC
- c) On transmission by the RNC of a RANAP RAB ASSIGNMENT RESPONSE message for PS domain, each RAB failed to modify is added to the relevant measurement according to the cause. Possible causes are included in TS 25.413 [5]. The sum of all supported per cause measurements shall equal the total number of RAB Modification Failures. In case only a subset of per cause measurements is supported, a sum measurement subtype will be provided first.

NOTE: The addition is performed with the condition that the RAB has been mentioned as queued in a previous RANAP RAB ASSIGNMENT RESPONSE and the RAB has been setup or modified successfully in a previous RANAP RAB ASSIGNMENT RESPONSE or RELOCATION REQUEST ACKNOWLEDGE.

- d) Each measurement is an integer value. The number of measurements is equal to the number of causes plus a possible sum value identified by the *.sum* suffix.
- e) The measurement name has the form RAB.FailModPSQueuing.*Cause* where *Cause* identifies the failure cause.
- f) RncFunction
- g) Valid for packet switched traffic.
- h) UMTS

4.1.6 RAB release request by CN for CS domain

The three measurement types defined in the clause 4.1.6 for CS domain are subject to the "2 out of 3 approach".

4.1.6.1 Attempted RAB releases for CS domain

- a) This measurement provides the number of requested RABs in release attempts for CS domain. The measurement is split into subcounters per release cause.
- b) CC
- c) On receipt by the RNC of a RANAP RAB ASSIGNMENT REQUEST message for CS domain, each requested RAB in release attempts is added to the relevant measurement according to the release cause requested. Possible causes are included in TS 25.413 [5]. The sum of all supported per cause measurements shall equal the total number of RAB Release Attempts. In case only a subset of per cause measurements is supported, a sum measurement subtype will be provided first. See TS 25.413 [5] and TS 23.107 [2].

- d) Each measurement is an integer value. The number of measurements is equal to the number of causes plus a possible sum value identified by the *.sum* suffix.
- e) The measurement name has the form RAB.AttRelCS.Cause where *Cause* identifies the release cause.
- f) RncFunction
- g) Valid for circuit switched traffic
- h) UMTS

4.1.6.2 Successful RAB releases for CS domain

- a) This measurement provides the number of successfully released RABs for CS domain. The measurement is split into subcounters per release cause.
- b) CC
- c) On transmission by the RNC of a RANAP RAB ASSIGNMENT RESPONSE message for CS domain, each successfully released RAB is added to the relevant measurement according to the release cause requested in the RAB ASSIGNMENT REQUEST message. Possible causes are included in TS 25.413 [5]. The sum of all supported per cause measurements shall equal the total number of RAB Release Successes. In case only a subset of per cause measurements is supported, a sum measurement subtype will be provided first. See TS 25.413 [5] and TS 23.107 [2].
- d) Each measurement is an integer value. The number of measurements is equal to the number of causes plus a possible sum value identified by the *.sum* suffix.
- e) The measurement name has the form RAB.SuccRelCS.Cause where *Cause* identifies the release cause.
- f) RncFunction
- g) Valid for circuit switched traffic
- h) UMTS

4.1.6.3 Failed RAB releases for CS domain

- a) This measurement provides the number of RABs failed to release for CS domain. The measurement is split into subcounters per failure cause.
- b) CC
- c) On transmission by the RNC of a RANAP RAB ASSIGNMENT RESPONSE message for CS domain, each RAB failed to release is added to the relevant measurement according to the failure cause. Possible causes are included in TS 25.413 [5]. The sum of all supported per cause measurements shall equal the total number of RAB Release Failures. In case only a subset of per cause measurements is supported, a sum measurement subtype will be provided first.
- d) Each measurement is an integer value. The number of measurements is equal to the number of causes supported plus a possible sum value identified by the *.sum* suffix.
- e) The measurement name has the form RAB.FailRelCS.Cause where *Cause* identifies the failure cause.
- f) RncFunction
- g) Valid for circuit switched traffic
- h) UMTS

4.1.6.4 Void 4.1.6.5 Void

4.1.7 RAB release request by CN for PS domain

The three measurement types defined in the clause 4.1.7 for PS domain are subject to the "2 out of 3 approach".

4.1.7.1 Attempted RAB releases for PS domain

- a) This measurement provides the number of requested RABs in release attempts for PS domain. The measurement is split into subcounters per release cause.
- b) CC
- c) On receipt by the RNC of a RANAP RAB ASSIGNMENT REQUEST message for PS domain, each requested RAB in release attempts is added to the relevant measurement according to the release cause. Possible causes are included in TS 25.413 [5]. The sum of all supported per cause measurements shall equal the total number of RAB Release Attempts. In case only a subset of per cause measurements is supported, a sum measurement subtype will be provided first. See TS 25.413 [5] and TS 23.107 [2].
- d) Each measurement is an integer value. The number of measurements is equal to the number of causes plus a possible sum value identified by the *.sum* suffix.
- e) The measurement name has the form RAB.AttRelPS.Cause where *Cause* identifies the release cause.
- f) RncFunction
- g) Valid for packet switched traffic.
- h) UMTS

4.1.7.2 Successful RAB releases for PS domain

- a) This measurement provides the number of successfully released RABs for PS domain. The measurement is split into subcounters per release cause.
- b) CC
- c) On transmission by the RNC of a RANAP RAB ASSIGNMENT RESPONSE message for PS domain, each successfully released RAB is added to the relevant measurement according to the release cause. Possible causes are included in TS 25.413 [5]. The sum of all supported per cause measurements shall equal the total number of RAB Release Successes. In case only a subset of per cause measurements is supported, a sum measurement subtype will be provided first. See TS 25.413 [5] and TS 23.107 [2].
- d) Each measurement is an integer value. The number of measurements is equal to the number of causes plus a possible sum value identified by the *.sum* suffix.
- e) The measurement name has the form RAB.SuccRelPS.Cause where *Cause* identifies the release cause.
- e) RncFunction
- f) Valid for packet switched traffic.
- g) UMTS

4.1.7.3 Failed RAB releases for PS domain

- a) This measurement provides the number of RABs failed to release for PS. The measurement is split into subcounters per failure cause.
- b) CC
- c) On transmission by the RNC of a RANAP RAB ASSIGNMENT RESPONSE message for PS domain, each RAB failed to release is added to the relevant measurement according to the failure cause. Possible causes are included in TS 25.413 [5]. The sum of all supported per cause measurements shall equal the total number of

RAB Release Failures. In case only a subset of per cause measurements is supported, a sum measurement subtype will be provided first.

- d) Each measurement is an integer value. The number of measurements is equal to the number of causes plus a possible sum value identified by the *.sum* suffix.
- e) The measurement name has the form RAB.FailRelPS.*Cause* where *Cause* identifies the failure cause.
- f) RncFunction
- g) Valid for packet switched traffic.
- h) UMTS

4.1.7.4 Void

4.1.7.5 Void

4.1.8 RAB setup time

4.1.8.1 RAB CS connection set-up time (Mean)

- a) This measurement provides the mean time during each granularity period for a RNC to establish a RAB CS connection.
- b) DER (n=1).
- c) This measurement is obtained by accumulating the time intervals for each successful RAB establishment between the receipt by the RNC of a RANAP "RAB ASSIGNMENT REQUEST" message to establish a RAB for CS domain, and the first corresponding (based on RAB ID) transmission by the RNC of a RANAP "RAB ASSIGNMENT RESPONSE" message for successfully established RABs over a granularity period using DER, see TS 25.413 [5]. This end value of the time will then be divided by the number of successfully established RABs observed in the granularity period to give the arithmetic mean, the accumulator shall be reinitialised at the beginning of each granularity period.
- d) Each measurement is an integer value.(in milliseconds).
- e) RAB.SuccEstabCSSetupTimeMean
- f) RncFunction
- g) Valid for circuit switched traffic
- h) UMTS

4.1.8.2 RAB CS connection set-up time (Maximum)

- a) This measurement provides the maximum time during each granularity period for a RNC to establish a RAB CS connection.
- b) GAUGE.
- c) This measurement is obtained by monitoring the time intervals for each successful RAB establishment between the receipt by the RNC of a RANAP "RAB ASSIGNMENT REQUEST" message to establish a RAB for CS domain, and the first corresponding (based on RAB ID) transmission by the RNC of a RANAP "RAB ASSIGNMENT RESPONSE" message for successfully established RABs see TS 25.413 [5]. The high tide mark of this time will be stored in a gauge, the gauge shall be reinitialised at the beginning of each granularity period.
- d) Each measurement is an integer value.(in milliseconds).

- e) RAB.SuccEstabCSSetupTimeMax
- f) RncFunction
- g) Valid for circuit switched traffic
- h) UMTS

4.1.8.3 RAB PS connection set-up time (Mean)

- a) This measurement provides the mean time during each granularity period for a RNC to establish a RAB PS connection.
- b) DER (n=1).
- c) This measurement is obtained by accumulating the time intervals for each successful RAB establishment between the receipt by the RNC of a RANAP "RAB ASSIGNMENT REQUEST" message to establish a RAB for PS domain, and the first corresponding (based on RAB ID) transmission by the RNC of a RANAP "RAB ASSIGNMENT RESPONSE" message for successfully established RABs over a granularity period using DER, see TS 25.413 [5]. This end value of the time will then be divided by the number of successfully established RABs observed in the granularity period to give the arithmetic mean, the accumulator shall be reinitialised at the beginning of each granularity period.
- d) Each measurement is an integer value.(in milliseconds).
- e) RAB.SuccEstabPSSetupTimeMean
- f) RncFunction
- g) Valid for packet switched traffic.
- h) UMTS

4.1.8.4 RAB PS connection set-up time (Maximum)

- a) This measurement provides the maximum time during each granularity period for a RNC to establish a RAB PS connection.
- b) GAUGE.
- c) This measurement is obtained by monitoring the time intervals for each successful RAB establishment between the receipt by the RNC of a RANAP "RAB ASSIGNMENT REQUEST" message to establish a RAB for PS domain, and the first corresponding (based on RAB ID) transmission by the RNC of a RANAP "RAB ASSIGNMENT RESPONSE" message for successfully established RABs see TS 25.413 [5]. The high tide mark of this time will be stored in a gauge, the gauge shall be reinitialised at the beginning of each granularity period.
- d) Each measurement is an integer value.(in milliseconds).
- e) RAB.SuccEstabPSSetupTimeMax
- f) RncFunction
- g) Valid for packet switched traffic.
- h) UMTS

4.1.9 RAB release request by UTRAN

4.1.9.1 RAB release requests for CS domain

- a) This measurement provides the number of RABs requested to release by UTRAN for CS domain split into subcounters per cause.
- b) CC
- c) On transmission by the RNC of a RANAP RAB RELEASE REQUEST message for CS domain, each RAB requested to be released is added to the relevant per cause measurement. Possible causes are included in TS 25.413 [5]. The sum of all supported per cause measurements shall equal the total number of RAB Release Requests for the CS domain. In case only a subset of per cause measurements is supported, a sum subcounter will be provided first.
- d) Each measurement is an integer value. The number of measurements is equal to the number of causes plus a possible sum value identified by the *.sum* suffix.
- e) The measurement name has the form RAB.RelReqCS.*Cause* where *Cause* identifies the release cause.
- f) RncFunction
- g) Valid for circuit switched traffic
- h) UMTS

4.1.9.2 RAB release requests for PS domain

- a) This measurement provides the number of RABs requested to release by UTRAN for PS domain split into subcounters per cause.
- b) CC
- c) On transmission by the RNC of a RANAP RAB RELEASE REQUEST message for PS domain, each RAB requested to be released is added to the relevant per cause measurement. Possible causes are included in TS 25.413 [5]. The sum of all supported per cause measurements shall equal the total number of RAB Release Requests for the PS domain. In case only a subset of per cause measurements is supported, a sum subcounter will be provided first.
- d) Each measurement is an integer value. The number of measurements is equal to the number of causes plus a possible sum value identified by the *.sum* suffix.
- e) The measurement name has the form RAB.RelReqPS.*Cause* where *Cause* identifies the release cause.
- f) RncFunction
- g) Valid for packet switched traffic.
- h) UMTS

4.1.9.3 The number of RAB related to the Iu release request for CS domain

- a) This measurement provides the number of RAB related to the Iu release request for CS domain. The measurement is split into subcounters per traffic class.
- b) CC
- c) On transmission by the RNC of a RANAP IU RELEASE REQUEST message for CS domain, each RAB related to the RANAP IU RELEASE REQUEST message is added to the relevant measurement according to the traffic class requested when the RANAP message IU RELEASE REQUEST is sent to the CS CN.
- d) Each measurement is an integer value

- e) RAB.NbrIuRelReqCS.Conv
RAB.NbrIuRelReqCS.Strm
RAB.NbrIuRelReqCS.Intact
RAB.NbrIuRelReqCS.Bgrd
- f) UtranCellFDD
UtranCellTDDLcr
UtranCellTDDHcr
- g) Valid for circuit switched traffic
- h) UMTS

4.1.9.4 The number of RAB related to the Iu release request for PS domain

- a) This measurement provides the number of RAB related to the Iu release request for PS domain. The measurement is split into subcounters per traffic class.
- b) CC
- c) On transmission by the RNC of a RANAP IU RELEASE REQUEST message for PS domain, each RAB related to the RANAP IU RELEASE REQUEST message is added to the relevant measurement according to the traffic class requested when the RANAP message IU RELEASE REQUEST is sent to the PS CN.
- d) Each measurement is an integer value.
- e) RAB.NbrIuRelReqPS.Conv
RAB.NbrIuRelReqPS.Strm
RAB.NbrIuRelReqPS.Intact
RAB.NbrIuRelReqPS.Bgrd
- f) UtranCellFDD
UtranCellTDDLcr
UtranCellTDDHcr
- g) Valid for packet switched traffic.
- h) UMTS

4.2 Void

4.3 Signalling connection establishment

4.3.1 Attempted signalling connection establishments for CS domain

- a) This measurement provides the number of attempts by RNC to establish an Iu control plane connection between the RNC and a CS CN.

NOTE: There is no confirmation in response to this message to indicate that the CN-RNC connection was successfully setup.

- b) CC
- c) Transmission of a RANAP Initial UE message by the RNC to the CN. This is sent by the RNC on receipt of an RRC Initial Direct Transfer message from the UE.
- d) A single integer value
- e) SIG.AttConnEstabCS.
- f) RncFunction

- g) Valid for circuit switching.
- h) UMTS

4.3.2 Attempted signalling connection establishments for PS domain

- a) This measurement provides the number of requests by RNC to establish an Iu control plane connection between the RNC and a PS CN.

NOTE: There is no confirmation in response to this message to indicate that the CN-RNC connection was successfully setup.

- b) CC
- c) Transmission of a RANAP Initial UE message by the RNC to the CN. This is sent by the RNC on receipt of an RRC Initial Direct Transfer message from the UE.
- d) A single integer value
- e) SIG.AttConnEstabPS.
- f) RncFunction
- g) Valid for packet switching.
- h) UMTS

4.4 RRC connection establishment

4.4.1 RRC connection establishments

The three measurement types defined in the clause 4.4.1.n are subject to the "2 out of 3 approach".

4.4.1.1 Attempted RRC connection establishments

- a) This measurement provides the number of RRC connection establishment attempts for each establishment cause.
- b) CC
- c) Receipt of an RRC Connection Request message by the RNC from the UE. Each RRC Connection Request message received is added to the relevant per cause measurement. The possible causes are included in TS 25.331 [4]. The sum of all supported per cause measurements shall equal the total number of RRC Connection Establishment attempts. In case only a subset of per cause measurements is supported, a sum subcounter will be provided first.
- d) Each measurement is an integer value. The number of measurements is equal to the number of causes plus a possible sum value identified by the *.sum* suffix.
- e) The measurement name has the form RRC.AttConnEstab.*Cause* where *Cause* identifies the Establishment Cause.
- f) UtranCellFDD
UtranCellTDDLcr
UtranCellTDDHcr
- g) Valid for circuit switched and packet switched traffic
- h) UMTS

4.4.1.2 Failed RRC connection establishments

- a) This measurement provides the number of RRC establishment failures for each rejection cause.

- b) CC
- c) Transmission of an RRC Connection Reject message by the RNC to the UE or an expected RRC CONNECTION SETUP COMPLETE message not received by the RNC. Each RRC Connection Reject message received is added to the relevant per cause measurement. The possible causes are included in TS 25.331 [4]. Each expected RRC CONNECTION SETUP COMPLETE not received by the RNC is added to the measurement cause 'No Reply' (not specified in TS 25.331 [4]). The sum of all supported per cause measurements shall equal the total number of RRC Connection Establishment Failures. In case only a subset of per cause measurements is supported, a sum subcounter will be provided first.
- d) Each measurement is an integer value. The number of measurements is equal to the number of causes plus a possible sum value identified by the *.sum* suffix.
- e) The measurement name has the form RRC.FailConnEstab.*Cause* where *Cause* identifies the Rejection Cause. The cause 'No Reply' is identified by the *.NoReply* suffix.
- f) UtranCellFDD
UtranCellTDDLcr
UtranCellTDDHcr
- g) Valid for circuit switched and packet switched traffic
- h) UMTS

4.4.1.3 Successful RRC connection establishments

- a) This measurement provides the number of successful RRC establishments for each establishment cause.
- b) CC
- c) Receipt by the RNC of a RRC CONNECTION SETUP COMPLETE message following a RRC establishment attempt. Each RRC Connection Setup Complete message received is added to the relevant per cause measurement. The possible causes are included in TS 25.331 [4]. The sum of all supported per cause measurements shall equal the total number of RRC Connection Establishments. In case only a subset of per cause measurements is supported, a sum subcounter will be provided first.
- d) Each measurement is an integer value. The number of measurements is equal to the number of causes plus a possible sum value identified by the *.sum* suffix.
- e) The measurement name has the form RRC.SuccConnEstab.*Cause* where *Cause* identifies the Establishment Cause.
- f) UtranCellFDD
UtranCellTDDLcr
UtranCellTDDHcr
- g) Valid for circuit switched and packet switched traffic
- h) UMTS

4.4.2 RRC connection establishment setup time

4.4.2.1 RRC connection set-up time (Mean)

- a) This measurement provides the mean time per establishment cause it takes for the RNC to establish a RRC connection during each granularity period. The measurement is split into subcounters per establishment cause.
- b) DER (n=1)
- c) This measurement is obtained by accumulating the time intervals for every successful RRC connection establishment per establishment cause between the receipt by the RNC from the UE of a "RRC CONNECTION REQUEST" and the corresponding "RRC CONNECTION SETUP COMPLETE" message over a granularity

period using DER. The end value of this time will then be divided by the number of successful RRC connections observed in the granularity period to give the arithmetic mean, the accumulator shall be reinitialised at the beginning of each granularity period. The measurement is split into subcounters per establishment cause, see TS 25.331 [4].

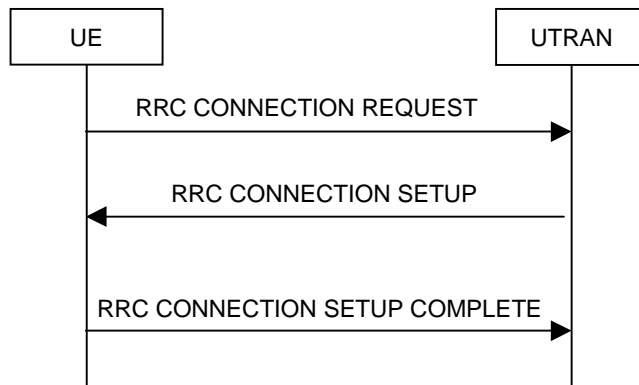

Figure

- d) Each measurement is an integer value.(in milliseconds)
- e) RRC.AttConnEstabTimeMean.Cause
where Cause identifies the Establishment Cause.
- f) UtranCellFDD
UtranCellTDDLcr
UtranCellTDDHcr
- g) Valid for circuit switched and packet switched traffic
- h) UMTS

4.4.2.2 RRC connection set-up time (Max)

- a) This measurement provides the maximum time per establishment cause it takes for the RNC in order to establish a RRC connection during each granularity period. The measurement is split into subcounters per establishment cause.
- b) GAUGE
- c) This measurement is obtained by monitoring the time intervals for each successful RRC connection establishment per establishment cause between the receipt by the RNC from the UE of a "RRC CONNECTION REQUEST" and the corresponding "RRC CONNECTION SETUP COMPLETE" message, see TS 25.331 [4]. The high tide mark of this time will be stored in a gauge, the gauge shall be reinitialised at the beginning of each granularity period. The measurement is split into subcounters per establishment cause.

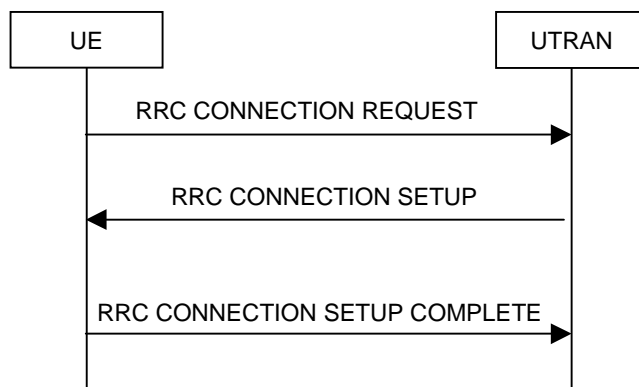

Figure

- d) Each measurement is an integer value.(in milliseconds)
- e) RRC.AttConnEstabTimeMax.Cause
where *Cause* identifies the Establishment Cause.
- f) UtranCellFDD
UtranCellTDDLcr
UtranCellTDDHcr
- g) Valid for circuit switched and packet switched traffic
- h) UMTS

4.4.3 RRC connection usage

4.4.3.1 General

The amount of RRC connections can be used to indicate user loading levels.

4.4.3.2 RRC connection usage (Mean)

- a) This measurement provides the average number of simultaneous RRC connections.
- b) SI
- c) This measurement is obtained by sampling at a pre-defined interval, the amount of successful RRC connections for each UtranCell and then taking the arithmetic mean.
- d) A single integer value
- e) RRC.MeanConn
- f) UtranCellFDD
UtranCellTDDLcr
UtranCellTDDHcr
- g) Valid for circuit switched and packet switched traffic
- h) UMTS

4.4.3.3 RRC connection usage (Maximum)

- a) This measurement provides the maximum number of simultaneous RRC connections.
- b) SI
- c) This measurement is obtained by sampling at a pre-defined interval, the amount of successful RRC connections for each UtranCell and then taking the maximum.
- d) A single integer value
- e) RRC.MaxConn.
- f) UtranCellFDD
UtranCellTDDLcr
UtranCellTDDHcr
- g) Valid for circuit switched and packet switched traffic
- h) UMTS

4.5 RRC connection re-establishment

The three measurement types defined in the subclause 4.5.n are subject to the "2 out of 3 approach".

4.5.1 Attempted RRC re-establishments

- a) This measurement provides the number of RRC re-establishments attempts.
- b) CC
- c) Receipt by the RNC of a CELL UPDATE message using the Cell Update cause "Radio link failure". See TS 25.331 [4].
- d) A single integer value
- e) RRC.AttConnReEstab.
- f) UtranCellFDD
UtranCellTDDLcr
UtranCellTDDHcr
- g) Valid for circuit switched and packet switched traffic
- h) UMTS

4.5.2 Failed RRC re-establishments

- a) This measurement provides the number of RRC re-establishment failures.
- b) CC
- c) Transmission of an RRC Connection Release message by RNC to the UE or an expected UTRAN Mobility Information Confirm message not received by RNC from the UE. See TS 25.331 [4].
Each RRC Connection Release message received is added to the relevant per cause measurement. The possible causes are included in TS 25.331 [4].
Each expected UTRAN Mobility Information Confirm message not received by the RNC is added to the measurement cause 'No Reply' (not specified in TS 25.331 [4]).
The sum of all supported per cause measurements shall equal the total number of RRC re-establishment failures. In case only a subset of per cause measurements is supported, a sum subcounter will be provided first.
- d) Each measurement is an integer value. The number of measurements is equal to the number of causes plus a possible sum value identified by the *.sum* suffix.
- e) The measurement name has the form RRC.FailConnReEstab.*Cause* where *Cause* identifies the Failure Cause.
The cause 'No Reply' is identified by the *.NoReply* suffix.
- f) UtranCellFDD
UtranCellTDDLcr
UtranCellTDDHcr
- g) Valid for circuit switched and packet switched traffic
- h) UMTS

4.5.3 Successful RRC re-establishments

- a) This measurement provides the number of successful RRC re-establishments.
- b) CC
- c) Receipt by the RNC of a UTRAN MOBILITY INFORMATION CONFIRM in a CELL UPDATE procedure using the value cause "Radio link failure". See TS 25.331 [4].

- d) A single integer value
- e) RRC.SuccConnReEstab.
- f) UtranCellFDD
UtranCellTDDLcr
UtranCellTDDHcr
- g) Valid for circuit switched and packet switched traffic
- h) UMTS

4.6 RRC connection release

4.6.1 Attempted RRC connection releases on DCCH

- a) This measurement provides the number of RRC connection release attempts per release cause sent from UTRAN to the UE on the DCCH.
- b) CC
- c) Transmission of an RRC CONNECTION RELEASE message by the RNC to the UE on DCCH. Each RRC Connection Release message sent on DCCH is added to the relevant per cause measurement. The possible causes are included in TS 25.331 [4]. The sum of all supported per cause measurements shall equal the total number of RRC Connection Release attempts on DCCH. In case only a subset of per cause measurements is supported, a sum subcounter will be provided first.
- d) Each measurement is an integer value. The number of measurements is equal to the number of causes plus a possible sum value identified by the *.sum* suffix.
- e) The measurement name has the form RRC.AttConnRelDCCH.*Cause* where *Cause* identifies the Release Cause.
- f) UtranCellFDD
UtranCellTDDLcr
UtranCellTDDHcr
- g) Valid for circuit switched and packet switched traffic
- h) UMTS

4.6.2 Attempted RRC connection releases on CCCH

- a) This measurement provides the number of RRC connection release attempts per release cause sent from UTRAN to the UE on the CCCH.
- b) CC
- c) Transmission by the RNC of an RRC CONNECTION RELEASE message to the UE on CCCH. Each RRC Connection Release message sent on CCCH is added to the relevant per cause measurement. The possible causes are included in TS 25.331 [4]. The sum of all supported per cause measurements shall equal the total number of RRC Connection Release attempts on CCCH. In case only a subset of per cause measurements is supported, a sum subcounter will be provided first.
- d) Each measurement is an integer value. The number of measurements is equal to the number of causes plus a possible sum value identified by the *.sum* suffix.
- e) The measurement name has the form RRC.AttConnRelCCCH.*Cause* where *Cause* identifies the Release Cause.
- f) UtranCellFDD
UtranCellTDDLcr
UtranCellTDDHcr

- g) Valid for circuit switched and packet switched traffic
- h) UMTS

4.7 RLC connection

4.7.1 Number of RLC blocks sent (per Mode)

- a) This measurement provides the number of RLC blocks sent by the RNC including retransmitted blocks.
- b) CC
- c) Transmission of RLC block, see TS 25.322 [10].
- d) RLC.NbrBlocksSent.TM
RLC.NbrBlocksSent.UM
RLC.NbrBlocksSent.AM
- e) A single integer value
- f) RncFunction, per Mode (Transparent, Unacknowledged and Acknowledged).
- g) Valid for packet switching and circuit switching.
- h) UMTS

4.7.2 Number of RLC blocks Received (per Mode)

- a) This measurement provides the number of received RLC blocks by the RNC.
- b) CC
- c) Receipt of a RLC blocks from a peer entity and before any error checking, see TS 25.322 [10].
- d) RLC.NbrBlocksReceived.TM
RLC.NbrBlocksReceived.UM
RLC.NbrBlocksReceived.AM
- e) A single integer value
- f) RncFunction per Mode (Transparent, Unacknowledged and Acknowledged).
- g) Valid for packet switching and circuit switching.
- h) UMTS

4.7.3 Discarded RLC blocks by RNC

- a) This measurement provides the number of discarded RLC blocks in case of error detection in the RNC (uplink transmission, RNC).
- b) CC
- c) Discard of a received block in the RNC, see TS 25.322 [10].
- d) RLC.DiscardedBlocksByRNC.
- e) A single integer value
- f) RncFunction
- g) Valid for packet switching.
- h) UMTS

4.7.4 Number of Retransmitted RLC blocks in Acknowledge Mode

- a) This measurement provides the number of retransmitted RLC blocks in RLC acknowledge mode, detected in the UE and signalled to the RNC (downlink transmission, UE).
- b) CC
- c) Receipt of a NACK or SACK block from the peer entity (UE) , see TS 25.322 [10].
- d) RLC.RetransmittedBlocksToUE.
- e) A single integer value
- f) RncFunction
- g) Valid for packet switching.
- h) UMTS

4.8 Soft handover

4.8.1 Radio link additions to active link set (UE side)

The three measurement types defined in the subclause 4.8.1.n for the radio link additions to active link set (UE side) are subject to the "2 out of 3 approach".

4.8.1.1 Attempted radio link additions to active link set (UE side)

- a) This measurement provides the number of attempted radio link additions during active link set update procedure (UE side) for each cell. This measurement shall be increased for each attempted radio link addition (UE side). This measurement is only valid for FDD mode.
- b) CC
- c) Transmission of an ACTIVE SET UPDATE message (RRC) by the serving RNC to the UE. Within an ACTIVE SET UPDATE message more than one radio link can be added. Each existing radio link addition information element shall be considered separately (see TS 25.331 [4]).
- d) A single integer value
- e) SHO.AttRLAddUESide.
- f) UtranCellFDD
- g) Valid for circuit switched and packet switched traffic
- h) UMTS

4.8.1.2 Successful radio link additions to active link set (UE side)

- a) This measurement provides the number of successful radio link additions during active link set update procedure (UE side) for each cell. This measurement shall be increased for each successful radio link addition (UE side). This measurement is only valid for FDD mode.
- b) CC
- c) Receipt of an ACTIVE SET UPDATE COMPLETE message (RRC), sent by the UE to the SERVING RNC, in response to an ACTIVE SET UPDATE message with one or more existing radio link addition information element. One ACTIVE SET UPDATE COMPLETE message can be related to more than one added radio link. Each successful added radio link shall be considered separately (see TS 25.331 [4]).
- d) A single integer value

- e) SHO.SuccRLAddUESide.
- f) UtranCellFDD
- g) Valid for circuit switched and packet switched traffic
- h) UMTS

4.8.1.3 Failed radio link additions to active link set (UE side)

- a) This measurement provides the number of failed radio link additions during active link set Update procedure (UE side) for each cell per cause. For each failure cause a separate subcounter is defined. Every failed radio link addition (UE side) shall be considered separately. This measurement is only valid for FDD mode.
- b) CC
- c) Receipt of an ACTIVE SET UPDATE FAILURE message (RRC) sent by UE to the UTRAN in response to an ACTIVE SET UPDATE message with non-empty radio link addition information element or an expected ACTIVE SET UPDATE COMPLETE message not received by the RNC. Each message can be related to more than one radio link.
 - Each failed attempt to add a radio link shall be considered separately and added to the relevant per cause measurement. Failure causes are defined within TS 25.331 [4].
 - Each expected ACTIVE SET UPDATE COMPLETE message not received by the RNC is added to the measurement cause 'No Reply' (not specified in TS 25.331 [4]).
 - The sum of all supported per cause measurements shall equal the total number of failures. In case only a subset of per cause measurements is supported, a sum subcounter will be provided first.
- d) Each measurement is an integer value. The number of measurements is equal to the number of causes supported plus a possible sum value identified by the *.sum* suffix.
- e) The measurement name has the form SHO.FailRLAddUESide.*Cause* where *Cause* identifies the failure cause. The cause 'No Reply' is identified by the *.NoReply* suffix.
- f) UtranCellFDD
- g) Valid for circuit switched and packet switched traffic
- h) UMTS

4.8.2 Radio link deletions from active link set (UE side)

4.8.2.1 Attempted radio link deletions from active link set (UE side)

- a) This measurement provides the number of attempted radio link deletions during active link set update procedure (UE side) for each cell. This measurement shall be increased for each attempted radio link deletion (UE side). This measurement is only valid for FDD mode.
- b) CC
- c) Transmission of an ACTIVE SET UPDATE message (RRC) by the SERVING RNC to the UE. Within an ACTIVE SET UPDATE message more than one radio link can be removed. Each existing radio link removal information element shall be considered separately (see TS 25.331 [4]).
- d) A single integer value
- e) SHO.AttRLDelUESide.
- f) UtranCellFDD
- g) Valid for circuit switched and packet switched traffic

h) UMTS

4.8.2.2 Successful radio link deletions from active link set (UE side)

- a) This measurement provides the number of successful radio link deletions during active link set update procedure (UE side) for each cell. This measurement shall be increased for each successful radio link deletion (UE side). This measurement is only valid for FDD mode.
- b) CC
- c) Receipt of an ACTIVE SET UPDATE COMPLETE message (RRC) sent by UE to the Serving RNC in response to an ACTIVE SET UPDATE message with one or more existing radio link removal information element. One ACTIVE SET UPDATE COMPLETE message can be related to more than one deleted radio link. Each successful deleted radio link shall be considered separately (see TS 25.331 [4]).
- d) A single integer value
- e) SHO.SuccRLDelUESide.
- f) UtranCellFDD
- g) Valid for circuit switched and packet switched traffic
- h) UMTS

4.8.3 Measurements related to the soft handover radio link

The following measurements are provided at the best UTRAN cell of the active set (UE side).

The "best" FDD cell has the largest value when the measurement quantity is "Ec/No" or "RSCP". On the other hand, the "best" cell has the smallest value when the measurement quantity is "Pathloss". See TS 25.331 [4].

The other UTRAN cell is other than the best UTRAN cell of active set (UE side).

4.8.3.1 Mean number of the radio link established by the best UTRAN cell

- a) This measurement provides the mean number of the radio link established by the measured UTRAN cell that is the best UTRAN cell of active set (UE side).
- b) SI.
- c) This measurement is obtained by RNC sampling at a pre-defined interval the number of the radio link established by the best UTRAN cell of active set (UE side), and then taking the arithmetic mean.
- d) A single integer value
- e) SHO.MeanNbrRLEstab.
- f) UtranCellFDD
- g) Valid for circuit switched and packet switched traffic
- h) UMTS

4.8.3.2 Mean number of the radio link established by other UTRAN cell

- a) This measurement provides the mean number of the radio link established by other UTRAN cell that is other than the best UTRAN cell of active set (UE side), also the best UTRAN cell of active set (UE side) is measured UTRAN cell.
- b) SI.

- c) This measurement is obtained by RNC sampling at a pre-defined interval the number of the radio link established by the other UTRAN cell that is other than the best UTRAN cell of active set (UE side), and then taking the arithmetic mean.
- d) A single integer value
- e) SHO.MeanNbrRLEstabByOthCell.
- f) UtranCellFDD
- g) Valid for circuit switched and packet switched traffic
- h) UMTS

4.9 Radio link management procedures

4.9.1 Overview

4.9.1.1 Considered radio link management procedures

Performance Measurement definitions in subclause 4.9 are based on the TS 25.423 [6] and TS 25.433 [7].

The following paragraphs are of interest for this purpose:

- Radio Link Setup (NBAP);
- Radio Link Addition (NBAP);
- Radio Link Deletion (NBAP);
- Radio Link Setup (RNSAP);
- Radio Link Addition (RNSAP);
- Radio Link Deletion (RNSAP);
- RADIO LINK SETUP REQUEST (NBAP);
- RADIO LINK SETUP RESPONSE (NBAP);
- RADIO LINK SETUP FAILURE (NBAP);
- RADIO LINK ADDITION REQUEST (NBAP);
- RADIO LINK ADDITION RESPONSE (NBAP);
- RADIO LINK ADDITION FAILURE (NBAP);
- RADIO LINK DELETION REQUEST (NBAP);
- RADIO LINK DELETION RESPONSE (NBAP);
- RADIO LINK SETUP REQUEST (RNSAP);
- RADIO LINK SETUP RESPONSE (RNSAP);
- RADIO LINK SETUP FAILURE (RNSAP);
- RADIO LINK ADDITION REQUEST (RNSAP);
- RADIO LINK ADDITION RESPONSE (RNSAP);
- RADIO LINK ADDITION FAILURE (RNSAP);

- RADIO LINK DELETION REQUEST (RNSAP);
- RADIO LINK DELETION RESPONSE (RNSAP).

These paragraphs show in particular the following diagrams:

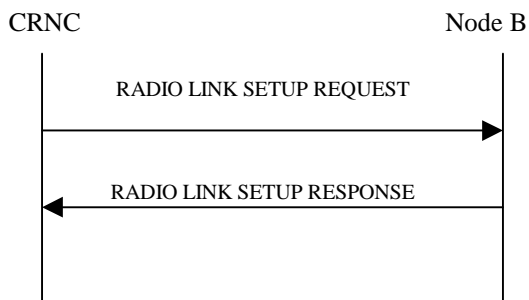

Figure: Radio Link Setup procedure on Iub, Successful Operation

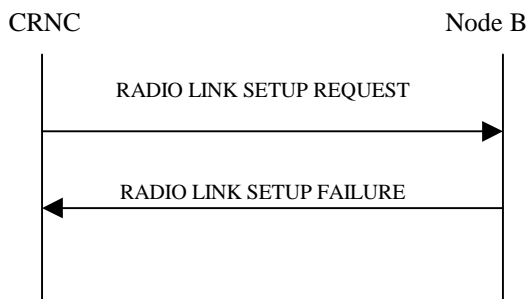

Figure: Radio Link Setup procedure on Iub, Unsuccessful Operation

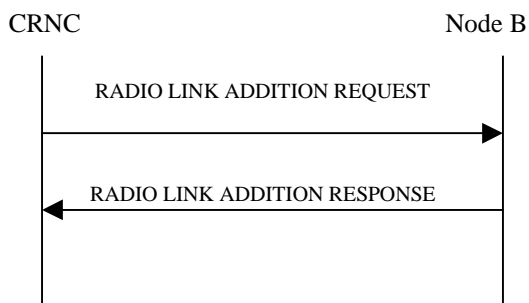

Figure: Radio Link Addition procedure on Iub, Successful Operation

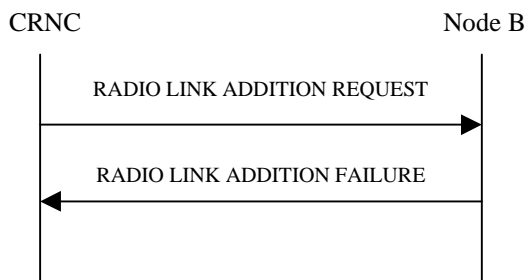

Figure: Radio Link Addition procedure on Iub, Unsuccessful Operation

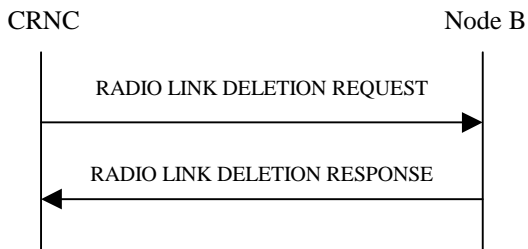

Figure: Radio Link Deletion procedure on Iub, Successful Operation

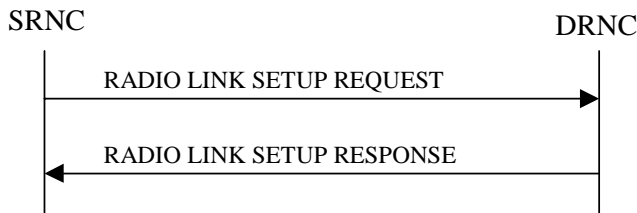

Figure: Radio Link Setup procedure on Iur, Successful Operation

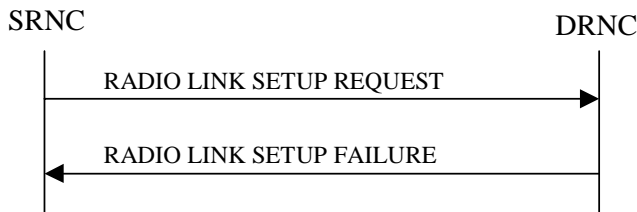

Figure: Radio Link Setup procedure on Iur, Unsuccessful Operation

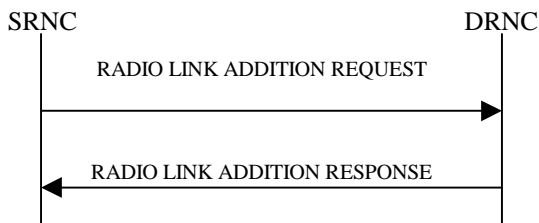

Figure: Radio Link Addition procedure on Iur, Successful Operation

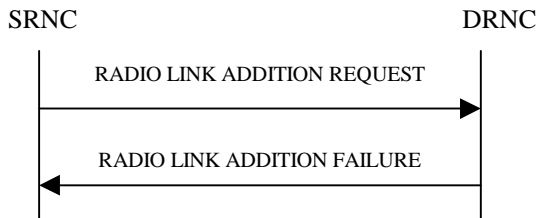

Figure: Radio Link Addition procedure on Iur, Unsuccessful Operation

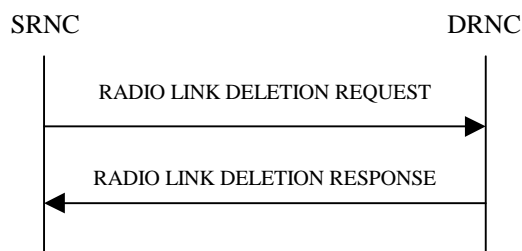

Figure: Radio Link Deletion procedure on Iur, Successful Operation

4.9.1.2 Relation between Iub measurements and Iur measurements

The following figure shows the relation between Iub interface and Iur interface. There are two cases for SRNC (CRNC1) to request radio link management activities in this figure.

In case (1), SRNC (CRNC1) sets up/adds/deletes radio links in NodeB1 and NodeB1 is directly controlled by SRNC (CRNC1).

In case (2/2bis), NodeB2 is directly controlled by DRNC (CRNC2). If SRNC (CRNC1) wants to set up/add/delete radio links in NodeB2, SRNC (CRNC1) will send request to DRNC (CRNC2), and DRNC (CRNC2) set up/add/delete radio links in NodeB2. In such case, if DRNC (CRNC2) fails to set up/add radio links in NodeB2 and receives failure message from NodeB2, DRNC (CRNC2) will send failure message back to SRNC (CRNC1). Furthermore if DRNC (CRNC2) has problem inside and fails to send request to NodeB2, it will send failure message back to the SRNC (CRNC1) directly.

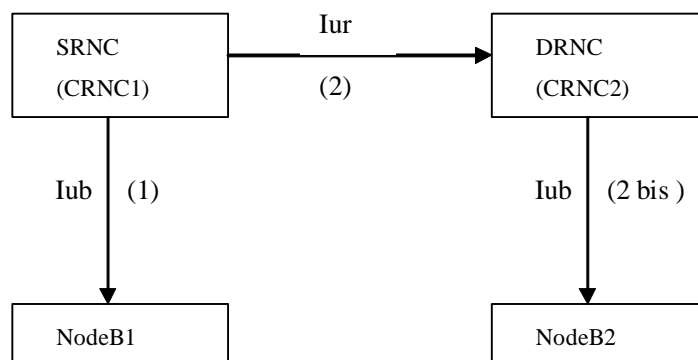

Figure: Relation between Iub interface and Iur interface

Subclause 4.9 has separated measurements for both Iur interface and Iub interface. From the above figure and description, we can see that the Iub interface measurements and Iur interface measurements overlap in some degree. Based on maintenance requirements, these two kinds measurements are needed and they are useful for operators to evaluate both the Iub interface and Iur interface, and to analyze all the failure cases they concern.

4.9.2 Radio link setups on Iub

The three measurement types defined in the subclauses 4.9.2.n for radio link setups on Iub are subject to the "2 out of 3 approach".

4.9.2.1 Attempted radio link setups on Iub

- a) This measurement provides the number of attempted radio link setups on Iub for each cell. This measurement shall be increased for each attempted radio link setup on Iub. This measurement is valid for FDD and TDD mode.
- b) CC

- c) Transmission of a RADIO LINK SETUP REQUEST message (NBAP) by the controlling RNC to the NodeB. Within a RADIO LINK SETUP REQUEST message more than one radio link can be set up. Each existing radio link information element shall be considered separately (see TS 25.433 [7]).
- d) A single integer value
- e) RLM.AttRLSetupIub.
- f) UtranCellFDD
UtranCellTDDLcr
UtranCellTDDHcr
- g) Valid for circuit switched and packet switched traffic
- h) UMTS

4.9.2.2 Successful radio link setups on Iub

- a) This measurement provides the number of successful radio link setups on Iub for each cell. This measurement shall be increased for each successful radio link setup on Iub. This measurement is valid for FDD and TDD mode.
- b) CC
- c) This measurement is based on two different events:
 - Receipt of a RADIO LINK SETUP RESPONSE message (NBAP) sent by NodeB to the controlling RNC in response to a RADIO LINK SETUP REQUEST message with one or more existing radio link information elements. One RADIO LINK SETUP RESPONSE message can be related to more than one radio link. Each radio link that is set up successfully shall be considered separately (see TS 25.433 [7]).
 - Receipt of a RADIO LINK SETUP FAILURE message (NBAP) sent by NodeB to the controlling RNC in response to a RADIO LINK SETUP REQUEST message with at least one Successful RL Information Response information element. One RADIO LINK SETUP FAILURE message can be related to more than one radio link. Each radio link that is set up successfully shall be considered separately (see TS 25.433 [7]).
- d) A single integer value
- e) RLM.SuccRLSetupIub.
- f) UtranCellFDD
UtranCellTDDLcr
UtranCellTDDHcr
- g) Valid for circuit switched and packet switched traffic
- h) UMTS

4.9.2.3 Failed radio link setups on Iub

- a) This measurement provides the number of failed radio link setups on Iub for each cell. This measurement shall be increased for each failed radio link setup on Iub. For each failure cause a separate measurement is defined. Every failed radio link setup on Iub shall be considered separately. This measurement is valid for FDD and TDD mode.
- b) CC
- c) Receipt of a RADIO LINK SETUP FAILURE message (NBAP) sent by NodeB to the controlling RNC in response to a RADIO LINK SETUP REQUEST message with one or more existing radio link information elements. One RADIO LINK SETUP FAILURE message can be related to more than one radio link. Each failed attempt to set up a radio link shall be considered separately. Failure causes are defined within TS 25.433 [7].

Each expected RADIO LINK SETUP RESPONSE or RADIO LINK SETUP FAILURE not received by the controlling RNC is added to the measurement cause 'No Reply' (not specified in TS 25.433 [7]).

The sum of all supported per cause measurements shall equal the total number of failures. In case only a subset of per cause measurements is supported, a sum measurement subtype will be provided first.

- d) Each measurement is an integer value. The number of measurements is equal to the number of causes supported plus a possible sum value identified by the *.sum* suffix.
- e) The measurement name has the form RLM.FailRLSetupIub.*Cause* where *Cause* identifies the failure cause.
- f) UtranCellFDD
UtranCellTDDLcr
UtranCellTDDHcr
- g) Valid for circuit switched and packet switched traffic
- h) UMTS

4.9.3 Radio link setups on Iur

The three measurement types defined in the subclauses 4.9.3.n for radio link setups on Iur are subject to the "2 out of 3 approach".

4.9.3.1 Attempted radio link setups on Iur

- a) This measurement provides the number of attempted radio link setups on Iur for each cell. This measurement shall be increased for each attempted radio link setup on Iur. This measurement is valid only for FDD mode.
- b) CC
- c) Receipt of a RADIO LINK SETUP REQUEST message (RNSAP) sent by the serving RNC to the drift RNC. Within a RADIO LINK SETUP REQUEST message more than one radio link can be set up. Each existing radio link information element shall be considered separately (see TS 25.423 [6]).
- d) A single integer value
- e) RLM.AttRLSetupIur.
- f) UtranCellFDD
- g) Valid for circuit switched and packet switched traffic
- h) UMTS

4.9.3.2 Successful radio link setups on Iur

- a) This measurement provides the number of successful radio link setups on Iur for each cell. This measurement shall be increased for each successful radio link setup on Iur. This measurement is valid only for FDD mode.
- b) CC
- c) This measurement is based on two different events:
 - Transmission of a RADIO LINK SETUP RESPONSE message (RNSAP) by the drift RNC to the serving RNC in response to a RADIO LINK SETUP REQUEST message with one or more existing radio link information elements. One RADIO LINK SETUP RESPONSE message can be related to more than one radio link. Each radio link that is set up successfully shall be considered separately (see TS 25.423 [6]).
 - Transmission of a RADIO LINK SETUP FAILURE message (RNSAP) by the drift RNC to the serving RNC in response to a RADIO LINK SETUP REQUEST message with at least one Successful RL Information Response information element. One RADIO LINK SETUP FAILURE message can be related to more than one radio link. Each radio link that is set up successfully shall be considered separately (see TS 25.423 [6]).
- d) A single integer value

- e) RLM.SuccRLSetupIur.
- f) UtranCellFDD
- g) Valid for circuit switched and packet switched traffic
- h) UMTS

4.9.3.3 Failed radio link setups on Iur

- a) This measurement provides the number of failed radio link setups on Iur for each cell. This measurement shall be increased for each failed radio link setup on Iur. For each failure cause a separate measurement is defined. Every failed radio link setup on Iur shall be considered separately. This measurement is valid only for FDD mode.
- b) CC
- c) Transmission of a RADIO LINK SETUP FAILURE message (RNSAP) by the drift RNC to the serving RNC in response to a RADIO LINK SETUP REQUEST message with one or more existing radio link information elements. One RADIO LINK SETUP FAILURE message can be related to more than one radio link. Each failed attempt to set up a radio link shall be considered separately. Failure causes are defined within TS 25.423 [6].

The sum of all supported per cause measurements shall equal the total number of failures. In case only a subset of per cause measurements is supported, a sum measurement subtype will be provided first.

- d) Each measurement is an integer value. The number of measurements is equal to the number of causes supported plus a possible sum value identified by the *.sum* suffix.
- e) The measurement name has the form RLM.FailRLSetupIur.*Cause* where *Cause* identifies the failure cause.
- f) UtranCellFDD
- g) Valid for circuit switched and packet switched traffic
- h) UMTS

4.9.4 Radio link additions on Iub

The three measurement types defined in the subclauses 4.9.4.n for radio link additions on Iub are subject to the "2 out of 3 approach".

4.9.4.1 Attempted radio link additions on Iub

- a) This measurement provides the number of attempted radio link additions on Iub for each cell. This measurement shall be increased for each attempted radio link addition on Iub. This measurement is valid for FDD and TDD mode.
- b) CC
- c) Transmission of a RADIO LINK ADDITION REQUEST message (NBAP) by the controlling RNC to the NodeB. Within a RADIO LINK ADDITION REQUEST message more than one radio link can be added. Each existing radio link information element shall be considered separately (see TS 25.433 [7]).
- d) A single integer value
- e) RLM.AttRLAddIub.
- f) UtranCellFDD
UtranCellTDDLcr
UtranCellTDDHcr
- g) Valid for circuit switched and packet switched traffic
- h) UMTS

4.9.4.2 Successful radio link additions on Iub

- a) This measurement provides the number of successful radio link additions on Iub for each cell. This measurement shall be increased for each successful radio link addition on Iub. This measurement is valid for FDD and TDD mode.
- b) CC
- c) This measurement is based on two different events:
 - Receipt of a RADIO LINK ADDITION RESPONSE message (NBAP) sent by NodeB to the controlling RNC in response to a RADIO LINK ADDITION REQUEST message with one or more existing radio link information elements. One RADIO LINK ADDITION RESPONSE message can be related to more than one added radio link. Each successful added radio link shall be considered separately (see TS 25.433 [7]).
 - Receipt of a RADIO LINK ADDITION FAILURE message (NBAP) sent by NodeB to the controlling RNC in response to a RADIO LINK ADDITION REQUEST message with at least one Successful RL Information Response information element. One RADIO LINK ADDITION FAILURE message can be related to more than one radio link. Each successful added radio link shall be considered separately (see TS 25.433 [7]).
- d) A single integer value
- e) RLM.SuccRLAddIub.
- f) UtranCellFDD
UtranCellTDDLcr
UtranCellTDDHcr
- g) Valid for circuit switched and packet switched traffic
- h) UMTS

4.9.4.3 Failed radio link additions on Iub

- a) This measurement provides the number of failed radio link additions on Iub for each cell. This measurement shall be increased for each failed radio link addition on Iub. For each failure cause a separate measurement is defined. Every failed radio link addition on Iub shall be considered separately. This measurement is valid for FDD and TDD mode.
- b) CC
- c) Receipt of a RADIO LINK ADDITION FAILURE message (NBAP) sent by NodeB to the controlling RNC in response to a RADIO LINK ADDITION REQUEST message with one or more existing radio link information elements. One RADIO LINK ADDITION FAILURE message can be related to more than one radio link. Each failed attempt to add a radio link shall be considered separately. Failure causes are defined within TS 25.433 [7].

Each expected RADIO LINK ADDITION RESPONSE or RADIO LINK ADDITION FAILURE not received by the controlling RNC is added to the measurement cause 'No Reply' (not specified in TS 25.433 [7]).

The sum of all supported per cause measurements shall equal the total number of failures. In case only a subset of per cause measurements is supported, a sum measurement subtype will be provided first.
- d) Each measurement is an integer value. The number of measurements is equal to the number of causes supported plus a possible sum value identified by the *.sum* suffix.
- e) The measurement name has the form RLM.FailRLAddIub.*Cause* where *Cause* identifies the failure cause.
- f) UtranCellFDD
UtranCellTDDLcr
UtranCellTDDHcr
- g) Valid for circuit switched and packet switched traffic
- h) UMTS

4.9.5 Radio link additions on Iur

The three measurement types defined in the subclauses 4.9.5.n for radio link additions on Iur are subject to the "2 out of 3 approach".

4.9.5.1 Attempted radio link additions on Iur

- a) This measurement provides the number of attempted radio link additions on Iur for each cell. This measurement shall be increased for each attempted radio link addition on Iur. This measurement is valid only for FDD mode.
- b) CC
- c) Receipt of a RADIO LINK ADDITION REQUEST message (RNSAP) sent by the serving RNC to the drift RNC. Within a RADIO LINK ADDITION REQUEST message more than one radio link can be added. Each existing radio link information element shall be considered separately (see TS 25.423 [6]).
- d) A single integer value
- e) RLM.AttRLAddIur.
- f) UtranCellFDD
- g) Valid for circuit switched and packet switched traffic
- h) UMTS

4.9.5.2 Successful radio link additions on Iur

- a) This measurement provides the number of successful radio link additions on Iur for each cell. This measurement shall be increased for each successful radio link addition on Iur. This measurement is valid only for FDD mode.
- b) CC
- c) This measurement is based on two different events:
 - Transmission of a RADIO LINK ADDITION RESPONSE message (RNSAP) by the drift RNC to the serving RNC in response to a RADIO LINK ADDITION REQUEST message with one or more existing radio link information elements. One RADIO LINK ADDITION RESPONSE message can be related to more than one added radio link. Each successful added radio link shall be considered separately (see TS 25.423 [6]).
 - Transmission of a RADIO LINK ADDITION FAILURE message (RNSAP) by the drift RNC to the serving RNC in response to a RADIO LINK ADDITION REQUEST message with at least one Successful RL Information Response information element. One RADIO LINK ADDITION FAILURE message can be related to more than one radio link. Each successful added radio link shall be considered separately (see TS 25.423 [6]).
- d) A single integer value
- e) RLM.SuccRLAddIur.
- f) UtranCellFDD
- g) Valid for circuit switched and packet switched traffic
- h) UMTS

4.9.5.3 Failed radio link additions on Iur

- a) This measurement provides the number of failed radio link additions on Iur for each cell. This measurement shall be increased for each failed radio link addition on Iur. For each failure cause a separate measurement is defined. Every failed radio link addition shall be considered separately. This measurement is valid only for FDD mode.
- b) CC

- c) Transmission of a RADIO LINK ADDITION FAILURE message (RNSAP) by the drift RNC to the serving RNC in response to a RADIO LINK ADDITION REQUEST message with one or more existing radio link information elements. One RADIO LINK ADDITION FAILURE message can be related to more than one radio link. Each failed attempt to add a radio link shall be considered separately. Failure causes are defined within TS 25.423 [6].

The sum of all supported per cause measurements shall equal the total number of Failures. In case only a subset of per cause measurements is supported, a sum measurement subtype will be provided first.

- d) Each measurement is an integer value. The number of measurements is equal to the number of causes supported plus a possible sum value identified by the *.sum* suffix.
- e) The measurement name has the form RLM.FailRLAddIur.*Cause* where *Cause* identifies the failure cause.
- f) UtranCellFDD
- g) Valid for circuit switched and packet switched traffic
- h) UMTS

4.9.6 Radio link deletions on Iub

4.9.6.1 Attempted radio link deletions on Iub

- a) This measurement provides the number of attempted radio link deletions on Iub for each cell. This measurement shall be increased for each attempted radio link deletion on Iub. This measurement is valid for FDD and TDD mode.
- b) CC
- c) Transmission of a RADIO LINK DELETION REQUEST message (NBAP) by the controlling RNC to the NodeB. Within a RADIO LINK DELETION REQUEST message more than one radio link can be removed. Each existing radio link information element shall be considered separately (see TS 25.433 [7]).
- d) A single integer value
- e) RLM.AttRLDeIub.
- f) UtranCellFDD
UtranCellTDDLcr
UtranCellTDDHcr
- g) Valid for circuit switched and packet switched traffic
- h) UMTS

4.9.6.2 Successful radio link deletions on Iub

- a) This measurement provides the number of successful radio link deletions on Iub for each cell. This measurement shall be increased for each successful radio link deletion on Iub. This measurement is valid for FDD and TDD mode.
- b) CC
- c) Receipt of a RADIO LINK DELETION RESPONSE message (NBAP) sent by NodeB to the controlling RNC in response to a RADIO LINK DELETION REQUEST message with one or more existing radio link removal information element. One RADIO LINK DELETION RESPONSE message can be related to more than one deleted radio link. Each successful deleted radio link shall be considered separately (see TS 25.433 [7]).
- d) A single integer value
- e) RLM.SuccRLDeIub.

- f) UtranCellFDD
UtranCellTDDLcr
UtranCellTDDHcr
- g) Valid for circuit switched and packet switched traffic
- h) UMTS

4.9.7 Radio link deletions on Iur

4.9.7.1 Attempted radio link deletions on Iur

- a) This measurement provides the number of attempted radio link deletions on Iur for each cell. This measurement shall be increased for each attempted radio link deletion on Iur. This measurement is valid only for FDD mode.
- b) CC
- c) Receipt of a RADIO LINK DELETION REQUEST message (RNSAP) sent by the serving RNC to the drift RNC. Within a RADIO LINK DELETION REQUEST message more than one radio link can be removed. Each existing radio link information element shall be considered separately (see TS 25.423 [6]).
- d) A single integer value
- e) RLM.AttRLDeIur.
- f) UtranCellFDD
- g) Valid for circuit switched and packet switched traffic
- h) UMTS

4.9.7.2 Successful radio link deletions on Iur

- a) This measurement provides the number of successful radio link deletions on Iur for each cell. This measurement shall be increased for each successful radio link deletion on Iur. This measurement is valid only for FDD mode.
- b) CC
- c) Transmission of a RADIO LINK DELETION RESPONSE message (RNSAP) by the drift RNC to the serving RNC in response to a RADIO LINK DELETION REQUEST message with one or more existing radio link removal information element. One RADIO LINK DELETION RESPONSE message can be related to more than one deleted radio link. Each successful deleted radio link shall be considered separately (see TS 25.423 [6]).
- d) A single integer value
- e) RLM.SuccRLDeIur.
- f) UtranCellFDD
- g) Valid for circuit switched and packet switched traffic
- h) UMTS

4.10 Hard handover

4.10.1 Void

4.10.2 Outgoing intra-NodeB hard handovers

The three measurement types defined in the subclause 4.10.2 for outgoing intra-NodeB hard handovers are subject to the "2 out of 3 approach".

4.10.2.1 Attempted outgoing intra-NodeB hard handovers

- a) This measurement provides the number of attempted outgoing intra-NodeB hard handovers.
- b) CC.
- c) Transmission of a RRC message PHYSICAL CHANNEL RECONFIGURATION, RADIO BEARER SETUP, RADIO BEARER RECONFIGURATION, RADIO BEARER RELEASE, or TRANSPORT CHANNEL RECONFIGURATION from the source RNC to the UE, indicating the attempt of an outgoing intra-NodeB hard handover (see TS 25.331 [4]).
- d) A single integer value.
- e) HHO.AttOutIntraNodeB.
- f) UtranCellFDD
UtranCellTDDLcr
UtranCellTDDHcr
- g) Valid for circuit switched and packet switched traffic.
- h) UMTS.

4.10.2.2 Successful outgoing intra-NodeB hard handovers

- a) This measurement provides the number of successful outgoing intra-NodeB hard handovers.
- b) CC.
- c) Receipt of a RRC message PHYSICAL CHANNEL RECONFIGURATION COMPLETE, RADIO BEARER SETUP COMPLETE, RADIO BEARER RECONFIGURATION COMPLETE, RADIO BEARER RELEASE COMPLETE, or TRANSPORT CHANNEL RECONFIGURATION COMPLETE sent from the UE to the source RNC, indicating a successful outgoing intra-NodeB hard handover (see TS 25.331 [4]).
- d) A single integer value.
- e) HHO.SuccOutIntraNodeB.
- f) UtranCellFDD
UtranCellTDDLcr
UtranCellTDDHcr
- g) Valid for circuit switched and packet switched traffic.
- h) UMTS.

4.10.2.3 Failed outgoing intra-NodeB hard handovers

- a) This measurement provides the number of failed outgoing intra-NodeB hard handovers per cause.
- b) CC.
- c) Receipt of a RRC message PHYSICAL CHANNEL RECONFIGURATION FAILURE, RADIO BEARER SETUP FAILURE, RADIO BEARER RECONFIGURATION FAILURE, RADIO BEARER RELEASE FAILURE, or TRANSPORT CHANNEL RECONFIGURATION FAILURE sent from the UE to the source RNC, indicating a failed outgoing intra-NodeB hard handover. Failure causes are defined within TS 25.331 [4].

Each expected RRC message PHYSICAL CHANNEL RECONFIGURATION COMPLETE, RADIO BEARER SETUP COMPLETE, RADIO BEARER RECONFIGURATION COMPLETE, RADIO BEARER RELEASE COMPLETE, TRANSPORT CHANNEL RECONFIGURATION COMPLETE, PHYSICAL CHANNEL RECONFIGURATION FAILURE, RADIO BEARER SETUP FAILURE, RADIO BEARER RECONFIGURATION FAILURE, RADIO BEARER RELEASE FAILURE, or TRANSPORT CHANNEL RECONFIGURATION FAILURE not received by the source RNC is added to the measurement cause 'No Reply' (not specified in TS 25.331 [4]).

The sum of all supported per cause measurements shall equal the total number of failed events. In case only a subset of per cause measurements is supported, a sum subcounter will be provided first.

- d) Each measurement is an integer value. The number of measurements is equal to the number of causes supported plus a possible sum value identified by the *.sum* suffix.
- e) The measurement name has the form `HHO.FailOutIntraNodeB.Cause` where *Cause* identifies the failure cause.
The cause 'No Reply' is identified by the *.NoReply* suffix.
- f) UtranCellFDD
UtranCellTDDLcr
UtranCellTDDHcr
- g) Valid for circuit switched and packet switched traffic.
- h) UMTS.

4.10.3 Outgoing inter-NodeB, intra-RNC hard handovers

The three measurement types defined in the subclause 4.10.3 for outgoing inter-NodeB, intra-RNC hard handovers are subject to the "2 out of 3 approach".

4.10.3.1 Attempted outgoing inter-NodeB, intra-RNC hard handovers

- a) This measurement provides the number of attempted outgoing inter-NodeB, intra-RNC hard handovers.
- b) CC.
- c) Transmission of a RRC message PHYSICAL CHANNEL RECONFIGURATION, RADIO BEARER SETUP, RADIO BEARER RECONFIGURATION, RADIO BEARER RELEASE, or TRANSPORT CHANNEL RECONFIGURATION from the source RNC to the UE, indicating the attempt of an outgoing inter-NodeB, intra-RNC hard handover (see TS 25.331 [4]).
- d) A single integer value.
- e) `HHO.AttOutInterNodeBIntraRNC`.
- f) UtranCellFDD
UtranCellTDDLcr
UtranCellTDDHcr
- g) Valid for circuit switched and packet switched traffic.
- h) UMTS.

4.10.3.2 Successful outgoing inter-NodeB, intra-RNC hard handovers

- a) This measurement provides the number of successful outgoing inter-NodeB, intra-RNC hard handovers.
- b) CC.
- c) Receipt of a RRC message PHYSICAL CHANNEL RECONFIGURATION COMPLETE, RADIO BEARER SETUP COMPLETE, RADIO BEARER RECONFIGURATION COMPLETE, RADIO BEARER RELEASE COMPLETE, or TRANSPORT CHANNEL RECONFIGURATION COMPLETE sent from the UE to the source RNC, indicating a successful outgoing inter-NodeB, intra-RNC hard handover (see TS 25.331 [4]).
- d) A single integer value.
- e) `HHO.SuccOutInterNodeBIntraRNC`.
- f) UtranCellFDD
UtranCellTDDLcr
UtranCellTDDHcr

- g) Valid for circuit switched and packet switched traffic.
- h) UMTS.

4.10.3.3 Failed outgoing inter-NodeB, intra-RNC hard handovers

- a) This measurement provides the number of failed outgoing inter-NodeB, intra-RNC hard handovers per cause.
- b) CC.
- c) Receipt of a RRC message PHYSICAL CHANNEL RECONFIGURATION FAILURE, RADIO BEARER SETUP FAILURE, RADIO BEARER RECONFIGURATION FAILURE, RADIO BEARER RELEASE FAILURE, or TRANSPORT CHANNEL RECONFIGURATION FAILURE sent from the UE to the source RNC, indicating a failed outgoing inter-NodeB, intra-RNC hard handover. Failure causes are defined within TS 25.331 [4].

Each expected RRC message PHYSICAL CHANNEL RECONFIGURATION COMPLETE, RADIO BEARER SETUP COMPLETE, RADIO BEARER RECONFIGURATION COMPLETE, RADIO BEARER RELEASE COMPLETE, TRANSPORT CHANNEL RECONFIGURATION COMPLETE, PHYSICAL CHANNEL RECONFIGURATION FAILURE, RADIO BEARER SETUP FAILURE, RADIO BEARER RECONFIGURATION FAILURE, RADIO BEARER RELEASE FAILURE, or TRANSPORT CHANNEL RECONFIGURATION FAILURE not received by the source RNC is added to the measurement cause 'No Reply' (not specified in TS 25.331 [4]).

The sum of all supported per cause measurements shall equal the total number of failed events. In case only a subset of per cause measurements is supported, a sum subcounter will be provided first.

- d) Each measurement is an integer value. The number of measurements is equal to the number of causes supported plus a possible sum value identified by the *.sum* suffix.
- e) The measurement name has the form HHO.FailOutInterNodeBIntraRNC.Cause where *Cause* identifies the failure cause. The cause 'No Reply' is identified by the *.NoReply* suffix.
- f) UtranCellFDD
UtranCellTDDLcr
UtranCellTDDHcr
- g) Valid for circuit switched and packet switched traffic.
- h) UMTS.

4.10.4 Outgoing inter-RNC hard handovers via Iur

The three measurement types defined in the subclause 4.10.4 for outgoing inter-RNC hard handovers are subject to the "2 out of 3 approach".

4.10.4.1 Attempted outgoing inter-RNC hard handovers via Iur

- a) This measurement provides the number of attempted outgoing inter-RNC hard handovers via Iur. This measurement is only valid for FDD mode.
- b) CC.
- c) Transmission of a RRC message PHYSICAL CHANNEL RECONFIGURATION, RADIO BEARER SETUP, RADIO BEARER RECONFIGURATION, RADIO BEARER RELEASE, or TRANSPORT CHANNEL RECONFIGURATION from the source RNC to the UE, indicating the attempt of an outgoing inter-RNC hard handover via Iur (see TS 25.331 [4]).
- d) A single integer value.
- e) HHO.AttOutInterRNCIur.

- f) UtranCellFDD
- g) Valid for circuit switched and packet switched traffic.
- h) UMTS.

4.10.4.2 Successful outgoing inter-RNC hard handovers via Iur

- a) This measurement provides the number of successful outgoing inter-RNC hard handovers via Iur. This measurement is only valid for FDD mode.
- b) CC.
- c) Receipt of a RRC message PHYSICAL CHANNEL RECONFIGURATION COMPLETE, RADIO BEARER SETUP COMPLETE, RADIO BEARER RECONFIGURATION COMPLETE, RADIO BEARER RELEASE COMPLETE, or TRANSPORT CHANNEL RECONFIGURATION COMPLETE sent from the UE to the source RNC, indicating a successful outgoing inter-RNC hard handover via Iur (see TS 25.331 [4]).
- d) A single integer value.
- e) HHO.SuccOutInterRNCIur.
- f) UtranCellFDD
- g) Valid for circuit switched and packet switched traffic.
- h) UMTS.

4.10.4.3 Failed outgoing inter-RNC hard handovers via Iur

- a) This measurement provides the number of failed outgoing inter-RNC hard handovers via Iur per cause. This measurement is only valid for FDD mode.
- b) CC.
- c) Receipt of a RRC message PHYSICAL CHANNEL RECONFIGURATION FAILURE, RADIO BEARER SETUP FAILURE, RADIO BEARER RECONFIGURATION FAILURE, RADIO BEARER RELEASE FAILURE, or TRANSPORT CHANNEL RECONFIGURATION FAILURE sent from the UE to the source RNC, indicating a failed outgoing inter-RNC hard handover via Iur. Failure causes are defined within TS 25.331 [4].

Each expected RRC message PHYSICAL CHANNEL RECONFIGURATION COMPLETE, RADIO BEARER SETUP COMPLETE, RADIO BEARER RECONFIGURATION COMPLETE, RADIO BEARER RELEASE COMPLETE, TRANSPORT CHANNEL RECONFIGURATION COMPLETE, PHYSICAL CHANNEL RECONFIGURATION FAILURE, RADIO BEARER SETUP FAILURE, RADIO BEARER RECONFIGURATION FAILURE, RADIO BEARER RELEASE FAILURE, or TRANSPORT CHANNEL RECONFIGURATION FAILURE not received by the source RNC is added to the measurement cause 'No Reply' (not specified in TS 25.331 [4]).

The sum of all supported per cause measurements shall equal the total number of failed events. In case only a subset of per cause measurements is supported, a sum subcounter will be provided first.

- d) Each measurement is an integer value. The number of measurements is equal to the number of causes supported plus a possible sum value identified by the *.sum* suffix.
- e) The measurement name has the form HHO.FailOutInterRNCIur.*Cause* where *Cause* identifies the failure cause. The cause 'No Reply' is identified by the *.NoReply* suffix.
- f) UtranCellFDD
- g) Valid for circuit switched and packet switched traffic.

4.10.5 Relocation preparation for outgoing inter-RNC hard handovers switching in the CN

The three measurement types defined in the subclause 4.10.5 for relocation preparation for outgoing inter-RNC hard handovers switching in the CN are subject to the "2 out of 3 approach".

4.10.5.1 Attempted relocation preparation for outgoing inter-RNC hard handovers switching in the CN

- a) This measurement provides the number of attempted relocation preparation for outgoing inter-RNC hard handovers switching in the CN.
- b) CC.
- c) Transmission of a RANAP message RELOCATION REQUIRED from the source RNC to the CN (Source side), indicating an attempted relocation preparation of a outgoing inter-RNC hard handover switching in the CN (see TS 25.413 [5]).
- d) A single integer value.
- e) HHO.AttRelocPrepOutInterRNCCN.
- f) UtranCellFDD
UtranCellTDDLcr
UtranCellTDDHcr
- g) Valid for circuit switched and packet switched traffic.
- h) UMTS.

4.10.5.2 Successful relocation preparation for outgoing inter-RNC hard handovers switching in the CN

- a) This measurement provides the number of successful relocation for outgoing inter-RNC hard handovers switching in the CN.
- b) CC.
- c) Receipt of a RANAP message RELOCATION COMMAND sent from the CN (Source side) to the source RNC, indicating a successful relocation preparation of a outgoing inter-RNC hard handover switching in the CN (see TS 25.413 [5]).
- d) A single integer value.
- e) HHO.SuccAttRelocPrepOutInterRNCCN.
- f) UtranCellFDD
UtranCellTDDLcr
UtranCellTDDHcr
- g) Valid for circuit switched and packet switched traffic.
- h) UMTS.

4.10.5.3 Failed relocation preparation for outgoing inter-RNC hard handovers switching in the CN

- a) This measurement provides number of failed relocation for outgoing inter-RNC hard handovers switching in the CN per cause.
- b) CC.

- c) Receipt of a RANAP message RELOCATION PREPARATION FAILURE sent from the CN (Source side) to the source RNC, indicating a failed relocation preparation for outgoing inter-RNC hard handover switching in the CN. Failure causes are defined within TS 25.413 [5]. The sum of all supported per cause measurements shall equal the total number of failed events. In case only a subset of per cause measurements is supported, a sum subcounter will be provided first.
- d) Each measurement is an integer value. The number of measurements is equal to the number of causes supported plus a possible sum value identified by the *.sum* suffix.
- e) The measurement name has the form HHO.FailRelocPrepOutInterRNCCN.Cause where *Cause* identifies the name of the failure cause.
- f) UtranCellFDD
UtranCellTDDLcr
UtranCellTDDHcr
- g) Valid for circuit switched and packet switched traffic.
- h) UMTS.

4.10.6 Outgoing inter-RNC hard handovers switching in the CN

The three measurement types defined in the subclause 4.10.6 for outgoing inter-RNC hard handovers switching in the CN are subject to the "2 out of 3 approach".

4.10.6.1 Attempted outgoing inter-RNC hard handovers switching in the CN

- a) This measurement provides the number of attempted outgoing inter-RNC hard handovers switching in the CN related to UEs.
- b) CC.
- c) Transmission of a RRC message PHYSICAL CHANNEL RECONFIGURATION, RADIO BEARER SETUP, RADIO BEARER RECONFIGURATION, RADIO BEARER RELEASE, or TRANSPORT CHANNEL RECONFIGURATION from the source RNC to the UE, indicating the attempt of an inter-RNC hard handover switching in the CN (see TS 25.331 [4]).
- d) A single integer value.
- e) HHO.AttOutInterRNCCN.
- f) UtranCellFDD
UtranCellTDDLcr
UtranCellTDDHcr
- g) Valid for circuit switched and packet switched traffic.
- h) UMTS.

4.10.6.2 Successful outgoing inter-RNC hard handovers switching in the CN

- a) This measurement provides the number of successful outgoing inter-RNC hard handovers switching in the CN related to UEs.
- b) CC.
- c) Receipt of a RANAP message Iu RELEASE COMMAND sent from the CN (Source side) to the source RNC, indicating a successful inter-RNC hard handover switching in the CN (see TS 25.413 [5]).
- d) A single integer value.
- e) HHO.SuccOutInterRNCCN.

- f) UtranCellFDD
UtranCellTDDLcr
UtranCellTDDHcr
- g) Valid for circuit switched and packet switched traffic.
- h) UMTS.

4.10.6.3 Failed outgoing inter-RNC hard handovers switching in the CN

- a) This measurement provides the number of failed outgoing inter-RNC hard handovers switching in the CN related to UEs.
- b) CC.
- c) Receipt of a RRC message PHYSICAL CHANNEL RECONFIGURATION FAILURE, RADIO BEARER SETUP FAILURE, RADIO BEARER RECONFIGURATION FAILURE, RADIO BEARER RELEASE FAILURE, or TRANSPORT CHANNEL RECONFIGURATION FAILURE sent from the UE to the source RNC, indicating a failed inter-RNC hard handover switching in the CN. Failure causes are defined within TS 25.331 [4].

Each expected RRC message PHYSICAL CHANNEL RECONFIGURATION COMPLETE, RADIO BEARER SETUP COMPLETE, RADIO BEARER RECONFIGURATION COMPLETE, RADIO BEARER RELEASE COMPLETE, TRANSPORT CHANNEL RECONFIGURATION COMPLETE, PHYSICAL CHANNEL RECONFIGURATION FAILURE, RADIO BEARER SETUP FAILURE, RADIO BEARER RECONFIGURATION FAILURE, RADIO BEARER RELEASE FAILURE, or TRANSPORT CHANNEL RECONFIGURATION FAILURE not received by the source RNC is added to the measurement cause 'No Reply' (not specified in TS 25.331 [4]).

The sum of all supported per cause measurements shall equal the total number of failed events. In case only a subset of per cause measurements is supported, a sum subcounter will be provided first.

- d) Each measurement is an integer value. The number of measurements is equal to the number of causes supported plus a possible sum value identified by the *.sum* suffix.
- e) The measurement name has the form HHO.FailOutInterRNCCN.*Cause* where *Cause* identifies the failure cause. The cause 'No Reply' is identified by the *.NoReply* suffix.
- f) UtranCellFDD
UtranCellTDDLcr
UtranCellTDDHcr
- g) Valid for circuit switched and packet switched traffic.
- h) UMTS.

4.10.7 Outgoing hard handovers per neighbour cell relation

The three measurement types defined in the subclause 4.10.7 for outgoing hard handovers per neighbour cell relation are subject to the "2 out of 3 approach".

4.10.7.1 Attempted outgoing hard handovers per neighbour cell relation

- a) This measurement provides the number of attempted outgoing hard handovers per neighbour cell relation.
- b) CC.
- c) Transmission of a RRC message PHYSICAL CHANNEL RECONFIGURATION, RADIO BEARER SETUP, RADIO BEARER RECONFIGURATION, RADIO BEARER RELEASE, or TRANSPORT CHANNEL RECONFIGURATION from the source RNC to the UE, indicating the attempt of an outgoing hard handover (see TS 25.331 [4]).

- d) A single integer value.
- e) HHO.AttOut.
- f) UtranRelation.
- g) Valid for circuit switched and packet switched traffic.
- h) UMTS.
- i) This measurement is mainly dedicated to Network Operator Maintenance and Vendor Performance Modelling Communities.

4.10.7.2 Successful outgoing hard handovers per neighbour cell relation

- a) This measurement provides the number of successful outgoing hard handovers per neighbour cell relation.
- b) CC.
- c) Receipt of a RRC message PHYSICAL CHANNEL RECONFIGURATION COMPLETE, RADIO BEARER SETUP COMPLETE, RADIO BEARER RECONFIGURATION COMPLETE, RADIO BEARER RELEASE COMPLETE, or TRANSPORT CHANNEL RECONFIGURATION COMPLETE sent from the UE to the source RNC, indicating a successful outgoing hard handover (see TS 25.331 [4]).
- d) A single integer value.
- e) HHO.SuccOut.
- f) UtranRelation.
- g) Valid for circuit switched and packet switched traffic.
- h) UMTS.
- i) This measurement is mainly dedicated to Network Operator Maintenance and Vendor Performance Modelling Communities.

4.10.7.3 Failed outgoing hard handovers per neighbour cell relation

- a) This measurement provides the number of failed outgoing hard handovers per neighbour cell relation per cause.
- b) CC.
- c) Receipt of a RRC message PHYSICAL CHANNEL RECONFIGURATION FAILURE, RADIO BEARER SETUP FAILURE, RADIO BEARER RECONFIGURATION FAILURE, RADIO BEARER RELEASE FAILURE, or TRANSPORT CHANNEL RECONFIGURATION FAILURE sent from the UE to the source RNC, indicating a failed outgoing hard handover. Failure causes are defined within TS 25.331 [4].

Each expected RRC message PHYSICAL CHANNEL RECONFIGURATION COMPLETE, RADIO BEARER SETUP COMPLETE, RADIO BEARER RECONFIGURATION COMPLETE, RADIO BEARER RELEASE COMPLETE, TRANSPORT CHANNEL RECONFIGURATION COMPLETE, PHYSICAL CHANNEL RECONFIGURATION FAILURE, RADIO BEARER SETUP FAILURE, RADIO BEARER RECONFIGURATION FAILURE, RADIO BEARER RELEASE FAILURE, or TRANSPORT CHANNEL RECONFIGURATION FAILURE not received by the source RNC is added to the measurement cause 'No Reply' (not specified in TS 25.331 [4]).

The sum of all supported per cause measurements shall equal the total number of failed events. In case only a subset of per cause measurements is supported, a sum subcounter will be provided first.

- d) Each measurement is an integer value. The number of measurements is equal to the number of causes supported plus a possible sum value identified by the *.sum* suffix.
- e) The measurement name has the form HHO.FailOut.*Cause* where *Cause* identifies the failure cause. The cause 'No Reply' is identified by the *.NoReply* suffix.

- f) UtranRelation.
- g) Valid for circuit switched and packet switched traffic.
- h) UMTS.
- i) This measurement is mainly dedicated to Network Operator Maintenance and Vendor Performance Modelling Communities.

4.11 Relocation

4.11.1 Relocations for CS domain

4.11.1.1 Relocation preparations with UE involved for CS domain

The three measurement types defined in the subclause 4.11.1.1.n for relocation preparations with UE involved for CS domain are subject to the "2 out of 3 approach".

4.11.1.1.1 Attempted relocation preparations with UE involved for CS domain

- a) This measurement provides the number of attempted relocation preparations with UE involved for CS domain.
- b) CC
- c) Transmission of a RANAP message RELOCATION REQUIRED from the source RNC to the CS CN (Source side) with Relocation Type set to "UE involved in relocation of SRNS", indicating an attempted relocation preparation with UE involved for CS domain (see TS 25.413 [5]).
- d) A single integer value
- e) RELOC.AttPrepUEInvolCS.
- f) RncFunction
- g) Valid for circuit switched traffic
- h) UMTS

4.11.1.1.2 Successful relocation preparations with UE involved for CS domain

- a) This measurement provides the number of successful relocation preparations with UE involved for CS domain.
- b) CC
- c) Receipt of a RANAP message RELOCATION COMMAND sent from the CS CN (Source side) to the source RNC, in response to a RELOCATION REQUIRED message with Relocation Type set to "UE involved in relocation of SRNS", indicating a successful relocation preparation with UE involved for CS domain (see TS 25.413 [5]).
- d) A single integer value
- e) RELOC.SuccPrepUEInvolCS.
- f) RncFunction
- g) Valid for circuit switched traffic
- h) UMTS

4.11.1.1.3 Failed relocation preparations with UE involved for CS domain

- a) This measurement provides the number of failed relocation preparations with UE involved for CS domain per cause.

- b) CC
- c) Receipt of a RANAP message RELOCATION PREPARATION FAILURE sent from the CS CN (Source side) to the source RNC, in response to a RELOCATION REQUIRED message with Relocation Type set to "UE involved in relocation of SRNS", indicating a failed relocation preparation with UE involved for CS domain. Failure causes are defined within TS 25.413 [5].

Each expected RANAP message RELOCATION COMMAND or RELOCATION PREPARATION FAILURE not received by the source RNC is added to the measurement cause 'No Reply' (not specified in TS 25.413 [5]).

The sum of all supported per cause measurements shall equal the total number of failed events. In case only a subset of per cause measurements is supported, a sum subcounter will be provided first.

- d) Each measurement is an integer value. The number of measurements is equal to the number of causes supported plus a possible sum value identified by the *.sum* suffix.
- e) The measurement name has the form RELOC.FailPrepUEInvolCS.*Cause* where *Cause* identifies the failure cause.
- f) RncFunction
- g) Valid for circuit switched traffic
- h) UMTS

4.11.1.2 Relocation preparations with UE not involved for CS domain

The three measurement types defined in the subclause 4.11.1.2.n for relocation preparations with UE not involved for CS domain are subject to the "2 out of 3 approach".

4.11.1.2.1 Attempted relocation preparations with UE not involved for CS domain

- a) This measurement provides the number of attempted relocation preparations with UE not involved for CS domain.
- b) CC
- c) Transmission of a RANAP message RELOCATION REQUIRED from the source RNC to the CS CN (Source side) with Relocation Type set to "UE not involved in relocation of SRNS", indicating an attempted relocation preparation with UE not involved for CS domain (see TS 25.413 [5]).
- d) A single integer value
- e) RELOC.AttPrepUENotInvolCS.
- f) RncFunction
- g) Valid for circuit switched traffic
- h) UMTS

4.11.1.2.2 Successful relocation preparations with UE not involved for CS domain

- a) This measurement provides the number of successful relocation preparations with UE not involved for CS domain.
- b) CC
- c) Receipt of a RANAP message RELOCATION COMMAND sent from the CS CN (Source side) to the source RNC, in response to a RELOCATION REQUIRED message with Relocation Type set to "UE not involved in relocation of SRNS", indicating a successful relocation preparation with UE not involved for CS domain (see TS 25.413 [5]).
- d) A single integer value

- e) RELOC.SuccPrepUENotInvolCS.
- f) RncFunction
- g) Valid for circuit switched traffic
- h) UMTS

4.11.1.2.3 Failed relocation preparations with UE not involved for CS domain

- a) This measurement provides the number of failed relocation preparations with UE not involved for CS domain per cause.
- b) CC
- c) Receipt of a RANAP message RELOCATION PREPARATION FAILURE sent from the CS CN (Source side) to the source RNC, in response to a RELOCATION REQUIRED message with Relocation Type set to "UE not involved in relocation of SRNS", indicating a failed relocation preparation with UE not involved for CS domain. Failure causes are defined within TS 25.413 [5].

Each expected RANAP message RELOCATION COMMAND or RELOCATION PREPARATION FAILURE not received by the source RNC is added to the measurement cause 'No Reply' (not specified in TS 25.413 [5]).

The sum of all supported per cause measurements shall equal the total number of failed events. In case only a subset of per cause measurements is supported, a sum subcounter will be provided first.

- d) Each measurement is an integer value. The number of measurements is equal to the number of causes supported plus a possible sum value identified by the *.sum* suffix.
- e) The measurement name has the form RELOC.FailPrepUENotInvolCS.*Cause* where *Cause* identifies the failure cause.
- f) RncFunction
- g) Valid for circuit switched traffic
- h) UMTS

4.11.1.3 Relocation resource allocations with UE involved for CS domain

The three measurement types defined in the subclause 4.11.1.3.n for relocation resource allocations with UE involved for CS domain are subject to the "2 out of 3 approach".

4.11.1.3.1 Attempted relocations resource allocations with UE involved for CS domain

- a) This measurement provides the number of attempted relocation resource allocations with UE involved for CS domain.
- b) CC
- c) Receipt of a RANAP message RELOCATION REQUEST sent from the CS CN (Target side) to the target RNC with Relocation Type set to "UE involved in relocation of SRNS", indicating an attempted relocation resource allocation with UE involved for CS domain (see TS 25.413 [5]).
- d) A single integer value
- e) RELOC.AttResAllocUEInvolCS.
- f) RncFunction
- g) Valid for circuit switched traffic
- h) UMTS

4.11.1.3.2 Successful relocation resource allocations with UE involved for CS domain

- a) This measurement provides the number of successful relocation resource allocations with UE involved for CS domain.
- b) CC
- c) Transmission of a RANAP message RELOCATION REQUEST ACKNOWLEDGE from the target RNC to the CS CN (Target side), in response to a RELOCATION REQUEST message with Relocation Type set to "UE involved in relocation of SRNS", indicating a successful relocation resource allocation with UE involved for CS domain (see TS 25.413 [5]).
- d) A single integer value
- e) RELOC.SuccResAllocUEInvolCS.
- f) RncFunction
- g) Valid for circuit switched traffic
- h) UMTS

4.11.1.3.3 Failed relocation resource allocations with UE involved for CS domain

- a) This measurement provides the number of failed relocation resource allocations with UE involved for CS domain per cause.
- b) CC
- c) Transmission of a RANAP message RELOCATION FAILURE from the target RNC to the CS CN (Target side), in response to a RELOCATION REQUEST message with Relocation Type set to "UE involved in relocation of SRNS", indicating a failed relocation resource allocation with UE involved for CS domain. Failure causes are defined within TS 25.413 [5].

The sum of all supported per cause measurements shall equal the total number of failed events. In case only a subset of per cause measurements is supported, a sum subcounter will be provided first.

- d) Each measurement is an integer value. The number of measurements is equal to the number of causes supported plus a possible sum value identified by the *.sum* suffix.
- e) The measurement name has the form RELOC.FailResAllocUEInvolCS.*Cause* where *Cause* identifies the failure cause.
- f) RncFunction
- g) Valid for circuit switched traffic
- h) UMTS

4.11.1.4 Relocation resource allocations with UE not involved for CS domain

The three measurement types defined in the subclause 4.11.1.4.n for relocation resource allocations with UE not involved for CS domain are subject to the "2 out of 3 approach".

4.11.1.4.1 Attempted relocations resource allocations with UE not involved for CS domain

- a) This measurement provides the number of attempted relocation resource allocations with UE not involved for CS domain.
- b) CC
- c) Receipt of a RANAP message RELOCATION REQUEST sent from the CS CN (Target side) to the target RNC with Relocation Type set to "UE not involved in relocation of SRNS", indicating an attempted relocation resource allocation with UE not involved for CS domain (see TS 25.413 [5]).

- d) A single integer value
- e) RELOC.AttResAllocUENotInvolCS
- f) RncFunction
- g) Valid for circuit switched traffic
- h) UMTS

4.11.1.4.2 Successful relocation resource allocations with UE not involved for CS domain

- a) This measurement provides the number of successful relocation resource allocations with UE not involved for CS domain.
- b) CC
- c) Transmission of a RANAP message RELOCATION REQUEST ACKNOWLEDGE from the target RNC to the CS CN (Target side), in response to a RELOCATION REQUEST message with Relocation Type set to "UE not involved in relocation of SRNS", indicating a successful relocation resource allocation with UE not involved for CS domain (see TS 25.413 [5]).
- d) A single integer value
- e) RELOC.SuccResAllocUENotInvolCS
- f) RncFunction
- g) Valid for circuit switched traffic
- h) UMTS

4.11.1.4.3 Failed relocation resource allocations with UE not involved for CS domain

- a) This measurement provides the number of failed relocation resource allocations with UE not involved for CS domain per cause.
- b) CC
- c) Transmission of a RANAP message RELOCATION FAILURE from the target RNC to the CS CN (Target side), in response to a RELOCATION REQUEST message with Relocation Type set to "UE not involved in relocation of SRNS", indicating a failed relocation resource allocation with UE not involved for CS domain. Failure causes are defined within TS 25.413 [5].

The sum of all supported per cause measurements shall equal the total number of failed events. In case only a subset of per cause measurements is supported, a sum subcounter will be provided first.

- d) Each measurement is an integer value. The number of measurements is equal to the number of causes supported plus a possible sum value identified by the *.sum* suffix.
- e) The measurement name has the form RELOC.FailResAllocUENotInvolCS.*Cause* where *Cause* identifies the failure cause.
- f) RncFunction
- g) Valid for circuit switched traffic
- h) UMTS

4.11.1.5 Relocations for CS domain

4.11.1.5.1 Successful relocations for CS domain

- a) This measurement provides the number of successful relocations for CS domain ('UE involved' and 'UE not involved' Relocations).
- b) CC
- c) Receipt of a RANAP message Iu RELEASE COMMAND sent from the CS CN (Source side) to the source RNC in response to a RELOCATION REQUIRED message, indicating a successful relocation for CS domain (see TS 25.413 [5]).
- d) A single integer value
- e) RELOC.SuccCS.
- f) RncFunction
- g) Valid for circuit switched traffic
- h) UMTS

4.11.2 Relocations for PS domain

4.11.2.1 Relocation preparations with UE involved for PS domain

The three measurement types defined in the subclause 4.11.2.1.n for relocation preparations with UE involved for PS domain are subject to the "2 out of 3 approach".

4.11.2.1.1 Attempted relocation preparations with UE involved for PS domain

- a) This measurement provides the number of attempted relocation preparations with UE involved for PS domain.
- b) CC
- c) Transmission of a RANAP message RELOCATION REQUIRED from the source RNC to the PS CN (Source side) with Relocation Type set to "UE involved in relocation of SRNS", indicating an attempted relocation preparation with UE involved for PS domain (see TS 25.413 [5]).
- d) A single integer value
- e) RELOC.AttPrepUEInvolPS.
- f) RncFunction
- g) Valid for packet switched traffic.
- h) UMTS

4.11.2.1.2 Successful relocation preparations with UE involved for PS domain

- a) This measurement provides the number of successful relocation preparations with UE involved for PS domain.
- b) CC
- c) Receipt of a RANAP message RELOCATION COMMAND sent from the PS CN (Source side) to the source RNC, in response to a RELOCATION REQUIRED message with Relocation Type set to "UE involved in relocation of SRNS", indicating a successful relocation preparation with UE involved for PS domain (see TS 25.413 [5]).
- d) A single integer value
- e) RELOC.SuccPrepUEInvolPS.

- f) RncFunction
- g) Valid for packet switched traffic.
- h) UMTS

4.11.2.1.3 Failed relocation preparations with UE involved for PS domain

- a) This measurement provides the number of failed relocation preparations with UE involved for PS domain per cause.
- b) CC
- c) Receipt of a RANAP message RELOCATION PREPARATION FAILURE sent from the PS CN (Source side) to the source RNC, in response to a RELOCATION REQUIRED message with Relocation Type set to "UE involved in relocation of SRNS", indicating a failed relocation preparation with UE involved for PS domain. Failure causes are defined within TS 25.413 [5].

Each expected RANAP message RELOCATION COMMAND or RELOCATION PREPARATION FAILURE not received by the source RNC is added to the measurement cause 'No Reply' (not specified in TS 25.413 [5]).

The sum of all supported per cause measurements shall equal the total number of failed events. In case only a subset of per cause measurements is supported, a sum subcounter will be provided first.

- d) Each measurement is an integer value. The number of measurements is equal to the number of causes supported plus a possible sum value identified by the *.sum* suffix.
- e) The measurement name has the form RELOC.FailPrepUEInvolPS.*Cause* where *Cause* identifies the failure cause.
- f) RncFunction
- g) Valid for packet switched traffic.
- h) UMTS

4.11.2.2 Relocation preparations with UE not involved for PS domain

The three measurement types defined in the subclause 4.11.2.2.n for relocation preparations with UE not involved for PS domain are subject to the "2 out of 3 approach".

4.11.2.2.1 Attempted relocation preparations with UE not involved for PS domain

- a) This measurement provides the number of attempted relocation preparations with UE not involved for PS domain.
- b) CC
- c) Transmission of a RANAP message RELOCATION REQUIRED from the source RNC to the PS CN (Source side) with Relocation Type set to "UE not involved in relocation of SRNS", indicating an attempted relocation preparation with UE not involved for PS domain (see TS 25.413 [5]).
- d) A single integer value
- e) RELOC.AttPrepUENotInvolPS.
- f) RncFunction
- g) Valid for packet switched traffic.
- h) UMTS

4.11.2.2.2 Successful relocation preparations with UE not involved for PS domain

- a) This measurement provides the number of successful relocation preparations with UE not involved for PS domain.
- b) CC
- c) Receipt of a RANAP message RELOCATION COMMAND sent from the PS CN (Source side) to the source RNC, in response to a RELOCATION REQUIRED message with Relocation Type set to "UE not involved in relocation of SRNS", indicating a successful relocation preparation with UE not involved for PS domain (see TS 25.413 [5]).
- d) A single integer value
- e) RELOC.SuccPrepUENotInvolPS.
- f) RncFunction
- g) Valid for packet switched traffic.
- h) UMTS

4.11.2.2.3 Failed relocation preparations with UE not involved for PS domain

- a) This measurement provides the number of failed relocation preparations with UE not involved for PS domain per cause.
- b) CC
- c) Receipt of a RANAP message RELOCATION PREPARATION FAILURE sent from the PS CN (Source side) to the source RNC, in response to a RELOCATION REQUIRED message with Relocation Type set to "UE not involved in relocation of SRNS", indicating a failed relocation preparation with UE not involved for PS domain. Failure causes are defined within TS 25.413 [5].

Each expected RANAP message RELOCATION COMMAND or RELOCATION PREPARATION FAILURE not received by the source RNC is added to the measurement cause 'No Reply' (not specified in TS 25.413 [5]).

The sum of all supported per cause measurements shall equal the total number of failed events. In case only a subset of per cause measurements is supported, a sum subcounter will be provided first.

- d) Each measurement is an integer value. The number of measurements is equal to the number of causes supported plus a possible sum value identified by the *.sum* suffix.
- e) The measurement name has the form RELOC.FailPrepUENotInvolPS.*Cause* where *Cause* identifies the failure cause.
- f) RncFunction
- g) Valid for packet switched traffic.
- h) UMTS

4.11.2.3 Relocation resource allocations with UE involved for PS domain

The three measurement types defined in the subclause 4.11.2.3.n for relocation resource allocations with UE involved for PS domain are subject to the "2 out of 3 approach".

4.11.2.3.1 Attempted relocations resource allocations with UE involved for PS domain

- a) This measurement provides the number of attempted relocation resource allocations with UE involved for PS domain.
- b) CC

- c) Receipt of a RANAP message RELOCATION REQUEST sent from the PS CN (Target side) to the target RNC with Relocation Type set to "UE involved in relocation of SRNS", indicating an attempted relocation resource allocation with UE involved for PS domain (see TS 25.413 [5]).
- d) A single integer value
- e) RELOC.AttResAllocUEInvolPS.
- f) RncFunction
- g) Valid for packet switched traffic.
- h) UMTS

4.11.2.3.2 Successful relocation resource allocations with UE involved for PS domain

- a) This measurement provides the number of successful relocation resource allocations with UE involved for PS domain.
- b) CC
- c) Transmission of a RANAP message RELOCATION REQUEST ACKNOWLEDGE from the target RNC to the PS CN (Target side), in response to a RELOCATION REQUEST message with Relocation Type set to "UE involved in relocation of SRNS", indicating a successful relocation resource allocation with UE involved for PS domain (see TS 25.413 [5]).
- d) A single integer value
- e) RELOC.SuccResAllocUEInvolPS.
- f) RncFunction
- g) Valid for packet switched traffic.
- h) UMTS

4.11.2.3.3 Failed relocation resource allocations with UE involved for PS domain

- a) This measurement provides the number of failed relocation resource allocations with UE involved for PS domain per cause.
- b) CC
- c) Transmission of a RANAP message RELOCATION FAILURE from the target RNC to the PS CN (Target side), in response to a RELOCATION REQUEST message with Relocation Type set to "UE involved in relocation of SRNS", indicating a failed relocation resource allocation with UE involved for PS domain. Failure causes are defined within TS 25.413 [5].

The sum of all supported per cause measurements shall equal the total number of failed events. In case only a subset of per cause measurements is supported, a sum subcounter will be provided first.

- d) Each measurement is an integer value. The number of measurements is equal to the number of causes supported plus a possible sum value identified by the *.sum* suffix.
- e) The measurement name has the form RELOC.FailResAllocUEInvolPS.*Cause* where *Cause* identifies the failure cause.
- f) RncFunction
- g) Valid for packet switched traffic.
- h) UMTS

4.11.2.4 Relocation resource allocations with UE not involved for PS domain

The three measurement types defined in the subclause 4.11.2.4.n for relocation resource allocations with UE not involved for PS domain are subject to the "2 out of 3 approach".

4.11.2.4.1 Attempted relocations resource allocations with UE not involved for PS domain

- a) This measurement provides the number of attempted relocation resource allocations with UE not involved for PS domain.
- b) CC
- c) Receipt of a RANAP message RELOCATION REQUEST sent from the PS CN (Target side) to the target RNC with Relocation Type set to "UE not involved in relocation of SRNS", indicating an attempted relocation resource allocation with UE not involved for PS domain (see TS 25.413 [5]).
- d) A single integer value
- e) RELOC.AttResAllocUENotInvolPS.
- f) RncFunction
- g) Valid for packet switched traffic.
- h) UMTS

4.11.2.4.2 Successful relocation resource allocations with UE not involved for PS domain

- a) This measurement provides the number of successful relocation resource allocations with UE not involved for PS domain.
- b) CC
- c) Transmission of a RANAP message RELOCATION REQUEST ACKNOWLEDGE from the target RNC to the PS CN (Target side), in response to a RELOCATION REQUEST message with Relocation Type set to "UE not involved in relocation of SRNS", indicating a successful relocation resource allocation with UE not involved for PS domain (see TS 25.413 [5]).
- d) A single integer value
- e) RELOC.SuccResAllocUENotInvolPS.
- f) RncFunction
- g) Valid for packet switched traffic.
- h) UMTS

4.11.2.4.3 Failed relocation resource allocations with UE not involved for PS domain

- a) This measurement provides the number of failed relocation resource allocations with UE not involved for PS domain per cause.
- b) CC
- c) Transmission of a RANAP message RELOCATION FAILURE from the target RNC to the PS CN (Target side), in response to a RELOCATION REQUEST message with Relocation Type set to "UE not involved in relocation of SRNS", indicating a failed relocation resource allocation with UE not involved for PS domain. Failure causes are defined within TS 25.413 [5].

The sum of all supported per cause measurements shall equal the total number of failed events. In case only a subset of per cause measurements is supported, a sum subcounter will be provided first.

- d) Each measurement is an integer value. The number of measurements is equal to the number of causes supported plus a possible sum value identified by the *.sum* suffix.

- e) The measurement name has the form RELOC.FailResAllocUENotInvolPS.*Cause* where *Cause* identifies the failure cause.
- f) RncFunction
- g) Valid for packet switched traffic.
- h) UMTS

4.11.2.5 Relocations for PS domain

4.11.2.5.1 Successful relocations for PS domain

- a) This measurement provides the number of successful relocations for PS domain ('UE involved' and 'UE not involved' Relocations).
- b) CC
- c) Receipt of a RANAP message Iu RELEASE COMMAND sent from the PS CN (Source side) to the source RNC in response to a RELOCATION REQUIRED message, indicating a successful relocation for PS domain (see TS 25.413 [5]).
- d) A single integer value
- e) RELOC.SuccPS.
- f) RncFunction
- g) Valid for packet switched traffic.
- h) UMTS

4.12 Circuit switched inter-RAT handover

4.12.1 Relocation preparation for outgoing circuit switched inter-RAT handovers

The three measurement types defined in the subclause 4.12.1.n for relocation preparation for outgoing circuit switched inter-RAT handovers are subject to the "2 out of 3 approach".

4.12.1.1 Attempted relocation preparation for outgoing circuit switched inter-RAT handovers

- a) This measurement provides the number of attempted relocation preparations for outgoing circuit switched inter-RAT handovers per neighbour cell.
- b) CC
- c) Transmission of a RANAP message RELOCATION REQUIRED from the serving RNC to the CN, indicating an attempted relocation preparation of an outgoing inter-RAT handover (see TS 25.413 [5]).
- d) A single integer value
- e) IRATHO.AttRelocPrepOutCS.
- f) GsmRelation.
- g) Valid for circuit switched traffic
- h) UMTS

4.12.1.2 Successful relocation preparation for outgoing circuit switched inter-RAT handovers

- a) This measurement provides the number of successful relocation preparations for outgoing circuit switched inter-RAT handovers per neighbour cell.
- b) CC
- c) Receipt of a RANAP message RELOCATION COMMAND sent from the CN to the serving RNC, indicating a successful relocation preparation of an inter-RAT handover (see TS 25.413 [5]).
- d) A single integer value
- e) IRATHO.SuccRelocPrepOutCS.
- f) GsmRelation.
- g) Valid for circuit switched traffic
- h) UMTS

4.12.1.3 Failed relocation preparation for outgoing circuit switched inter-RAT handovers

- a) This measurement provides number of failed relocation preparations for outgoing circuit switched inter-RAT handovers per neighbour cell per cause.
- b) CC
- c) Receipt of a RANAP message RELOCATION PREPARATION FAILURE sent from the CN to the serving RNC, indicating a failed relocation preparation for outgoing inter-RAT handovers. Failure causes are defined within TS 25.413 [5].
The sum of all supported per cause measurements shall equal the total number of failed events. In case only a subset of per cause measurements is supported, a sum subcounter will be provided first.
- d) Each measurement is an integer value. The number of measurements is equal to the number of causes supported plus a possible sum value identified by the *.sum* suffix.
- e) The measurement name has the form IRATHO.FailRelocPrepOutCS.*Cause* where *Cause* identifies the failure cause.
- f) GsmRelation.
- g) Valid for circuit switched traffic
- h) UMTS

4.12.2 Outgoing circuit switched inter-RAT handovers

The three measurement types defined in the subclause 4.12.2.n for outgoing circuit switched inter-RAT handovers are subject to the "2 out of 3 approach".

4.12.2.1 Attempted outgoing circuit switched inter-RAT handovers

- a) This measurement provides the number of attempted outgoing circuit switched inter-RAT handovers per neighbour cell from UEs point of view.
- b) CC
- c) Transmission of a RRC-message HANDOVER FROM UTRAN COMMAND from serving RNC to the UE, indicating an attempted outgoing inter-RAT handover (see TS 25.331 [4]).
- d) A single integer value

- e) IRATHO.AttOutCS.
- f) GsmRelation.
- g) Valid for circuit switched traffic
- h) UMTS

4.12.2.2 Successful outgoing circuit switched inter-RAT handovers

- a) This measurement provides the number of successful outgoing circuit switched inter-RAT handovers per neighbour cell from UEs point of view.
- b) CC
- c) Receipt of a RANAP message IU RELEASE COMMAND sent from the CN to the serving RNC, indicating a successful inter-RAT handover (see TS 25.413 [5]).
- d) A single integer value
- e) IRATHO.SuccOutCS.
- f) GsmRelation.
- g) Valid for circuit switched traffic
- h) UMTS

4.12.2.3 Failed outgoing circuit switched inter-RAT handovers

- a) This measurement provides the number of failed outgoing circuit switched inter-RAT handovers per neighbour cell per cause from UEs point of view, where the UE returned to the original physical channel configuration.
- b) CC
- c) Receipt of a RRC message HANDOVER FROM UTRAN FAILURE sent from the UE to the serving RNC, indicating a failed inter-RAT handover. Failure causes are defined within TS 25.331 [4].
The sum of all supported per cause measurements shall equal the total number of failed events. In case only a subset of per cause measurements is supported, a sum subcounter will be provided first.
- d) Each measurement is an integer value. The number of measurements is equal to the number of causes supported plus a possible sum value identified by the *.sum* suffix.
- e) The measurement name has the form IRATHO.FailOutCS.*Cause* where *Cause* identifies the failure cause.
- f) GsmRelation.
- g) Valid for circuit switched traffic
- h) UMTS

4.12.3 Incoming circuit switched inter-RAT handovers

The three measurement types defined in the subclause 4.12.3.n for incoming circuit switched inter-RAT handovers are subject to the "2 out of 3 approach".

4.12.3.1 Attempted incoming circuit switched inter-RAT handovers

- a) This measurement provides the number of attempted incoming circuit switched inter-RAT handovers for each cell.
- b) CC

- c) Receipt of a RANAP RELOCATION REQUEST message sent from the CN to the target RNC, indicating the attempt of an inter-RAT handover (see TS 25.413 [5]).
- d) A single integer value
- e) IRATHO.AttIncCS.
- f) UtranCellFDD
UtranCellTDDLcr
UtranCellTDDHcrValid for circuit switched traffic
- g) UMTS

4.12.3.2 Successful incoming circuit switched inter-RAT handovers

- a) This measurement provides the number of successful incoming circuit switched interRAT handovers for each cell.
- b) CC
- c) Receipt of a RRC HANDOVER TO UTRAN COMPLETE message sent from the UE to the target RNC, indicating a successful interRAT handover (see TS 25.331 [4]).
- d) A single integer value
- e) IRATHO.SuccIncCS.
- f) UtranCellFDD
UtranCellTDDLcr
UtranCellTDDHcrValid for circuit switched traffic
- g) UMTS

4.12.3.3 Failed incoming circuit switched inter-RAT handovers

- a) This measurement provides the number of failed incoming circuit switched interRAT handovers per cell per cause.
- b) CC
- c) Transmission of a RANAP message RELOCATION FAILURE from the target RNC to the CN, indicating a failed inter-RAT handovers. Failure causes are defined within TS 25.413 [5].
The sum of all supported per cause measurements shall equal the total number of failed events. In case only a subset of per cause measurements is supported, a sum subcounter will be provided first.
- d) Each measurement is an integer value. The number of measurements is equal to the number of causes supported plus a possible sum value identified by the *.sum* suffix.
- e) The measurement name has the form IRATHO.FailIncCS.*Cause* where *Cause* identifies the failure cause.
- f) UtranCellFDD
UtranCellTDDLcr
UtranCellTDDHcrValid for circuit switched traffic
- g) UMTS

4.13 Packet switched inter-RAT handover

4.13.1 Outgoing packet switched inter-RAT handovers, UTRAN controlled

The three measurement types defined in the subclause 4.13.1.n for outgoing packet switched inter-RAT handovers, UTRAN controlled are subject to the "2 out of 3 approach".

4.13.1.1 Attempted outgoing packet switched inter-RAT handovers, UTRAN controlled

- a) This measurement provides the number of attempted outgoing, UTRAN controlled, Packet Switched interRAT handovers per cell.
- b) CC
- c) Transmission of a RRC-message, CELL CHANGE ORDER FROM UTRAN, from source RNC to the UE, indicating an attempted outgoing Packet Switched inter-RAT handover (see TS 25.331 [4]).
- d) A single integer value
- e) IRATHO.AttOutPSUTRAN.
- f) UtranCellFDD
UtranCellTDDLcr
UtranCellTDDHcr
- g) Valid for packet switched traffic.
- h) UMTS

4.13.1.2 Successful outgoing packet switched inter-RAT handovers, UTRAN controlled

- a) This measurement provides the number of successful outgoing, UTRAN controlled, Packet Switched interRAT handovers per cell.
- b) CC
- c) Receipt of a RANAP message, IU RELEASE COMMAND, sent from the PS CN to the source RNC, indicating a successful outgoing Packet Switched inter-RAT handover (see TS 25.413 [5]).
- d) A single integer value
- e) IRATHO.SuccOutPSUTRAN.
- f) UtranCellFDD
UtranCellTDDLcr
UtranCellTDDHcr
- g) Valid for packet switched traffic.
- h) UMTS

4.13.1.3 Failed outgoing packet switched inter-RAT handovers UTRAN controlled

- a) This measurement provides the number of failed outgoing, UTRAN controlled, Packet Switched interRAT handovers per cause, where the UE resumes the connection to UTRAN using the same resources used before receiving the cell change order. This is measured per cell.
- b) CC
- c) Receipt of an RRC message, CELL CHANGE ORDER FROM UTRAN FAILURE, sent from the UE to the source RNC, indicating a failed inter-RAT handover. Failure causes are defined within TS 25.331 [4].
The sum of all supported per cause measurements shall equal the total number of failed events. In case only a subset of per cause measurements is supported, a sum subcounter will be provided first.
- d) Each measurement is an integer value. The number of measurements is equal to the number of causes supported plus a possible sum value identified by the *.sum* suffix.
- e) The measurement name has the form IRATHO.FailOutPSUTRAN.Cause
where *Cause* identifies the failure cause.

- f) UtranCellFDD
UtranCellTDDLcr
UtranCellTDDHcr
- g) Valid for packet switched traffic.
- h) UMTS

4.13.2 Outgoing packet switched inter-RAT handovers, UE controlled

4.13.2.1 Successful outgoing packet switched inter-RAT handovers, UE controlled

- a) This measurement provides the number of successful outgoing, UE controlled, Packet Switched inter-RAT handovers per cell.
- b) CC
- c) Receipt of an RANAP message, SRNS CONTEXT REQUEST, sent from the PS CN to the serving RNC, indicating a successful outgoing UE controlled Packet Switched inter-RAT handover (see TS 25.413 [5]).
- d) A single integer value
- e) IRATHO.SuccOutPSUE.
- f) UtranCellFDD
UtranCellTDDLcr
UtranCellTDDHcr
- g) Valid for packet switched traffic.
- h) UMTS

4.14 Iu connection release

4.14.1 Overview

4.14.1.1 Considered Iu connection release procedures

Performance Measurement definitions in this subclause are based on TS 25.413 [5].

The following paragraphs are of interest for this purpose:

- Iu Release Request;
- Iu Release;
- IU RELEASE REQUEST;
- IU RELEASE COMMAND;
- IU RELEASE COMPLETE.

These paragraphs show in particular the following diagrams:



Figure: Iu Release Request procedure. Successful operation

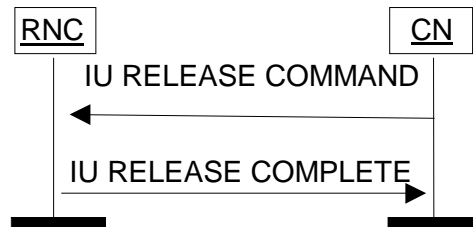

Figure: Iu Release procedure. Successful operation

4.14.2 Iu connection release request by UTRAN

4.14.2.1 Attempted Iu connection release request by UTRAN for CS domain

- a) This measurement provides the number of attempted requests by UTRAN to release an Iu connection between the RNC and a CS CN. The measurement is split into subcounters per release cause.
- b) CC
- c) Transmission of a RANAP message IU RELEASE REQUEST by the RNC to the CS CN. Each RANAP message IU RELEASE REQUEST sent to the CS CN is added to the relevant per cause measurement. The possible causes are included in TS 25.413 [5]. The sum of all supported per cause measurements shall equal the total number of IU RELEASE REQUEST attempts. In case only a subset of per cause measurements is supported, a sum measurement subtype will be provided first.
- d) Each measurement is an integer value. The number of measurements is equal to the number of causes plus a possible sum value identified by the *.sum* suffix.
- e) The measurement name has the form *IU.AttConnRelReqUTRANCSCause* where *Cause* identifies the release cause.
- f) RncFunction
- g) Valid for circuit switched traffic
- h) UMTS

4.14.2.2 Attempted Iu connection release request by UTRAN for PS domain

- a) This measurement provides the number of attempted requests by UTRAN to release an Iu connection between the RNC and a PS CN. The measurement is split into subcounters per release cause.
- b) CC
- c) Transmission of a RANAP message IU RELEASE REQUEST by the RNC to the PS CN. Each RANAP message IU RELEASE REQUEST sent to the PS CN is added to the relevant per cause measurement. The possible release causes are included in TS 25.413 [5]. The sum of all supported per cause measurements shall equal the total number of IU RELEASE REQUEST attempts. In case only a subset of per cause measurements is supported, a sum measurement subtype will be provided first.
- d) Each measurement is an integer value. The number of measurements is equal to the number of causes plus a possible sum value identified by the *.sum* suffix.

- e) The measurement name has the form *IU.AttConnRelReqUTRANPS.Cause* where *Cause* identifies the release cause.
- f) RncFunction
- g) Valid for packet switched traffic.
- h) UMTS

4.14.3 Iu connection release by CN

4.14.3.1 Attempted Iu connection release by CN for CS domain

- a) This measurement provides the number of attempted release by a CS CN to an Iu connection between the RNC and a CS CN. The measurement is split into subcounters per release cause.
- b) CC
- c) Receipt of a RANAP message IU RELEASE COMMAND sent by the CS CN to the RNC. Each RANAP message IU RELEASE COMMAND received from the CS CN is added to the relevant per cause measurement. The possible causes are included in TS 25.413 [5]. The sum of all supported per cause measurements shall equal the total number of IU RELEASE COMMAND attempts. In case only a subset of per cause measurements is supported, a sum measurement subtype will be provided first.
- d) Each measurement is an integer value. The number of measurements is equal to the number of causes plus a possible sum value identified by the *.sum* suffix.
- e) The measurement name has the form *IU.AttConnRelCNCS.Cause* where *Cause* identifies the release cause.
- f) RncFunction
- g) Valid for circuit switching.
- h) UMTS

4.14.3.2 Attempted Iu connection release by CN for PS domain

- a) This measurement provides the number of attempted release by a PS CN to an Iu connection between the RNC and a PS CN. The measurement is split into subcounters per release cause.
- b) CC
- c) Receipt of a RANAP message IU RELEASE COMMAND sent by the PS CN to the RNC. Each RANAP message IU RELEASE COMMAND received from the PS CN is added to the relevant per cause measurement. The possible causes are included in TS 25.413 [5]. The sum of all supported per cause measurements shall equal the total number of IU RELEASE COMMAND attempts. In case only a subset of per cause measurements is supported, a sum measurement subtype will be provided first.
- d) Each measurement is an integer value. The number of measurements is equal to the number of causes plus a possible sum value identified by the *.sum* suffix.
- e) The measurement name has the form *IU.AttConnRelCNPS.Cause* where *Cause* identifies the release cause.
- f) RncFunction
- g) Valid for packet switching.
- h) UMTS

4.14.3.3 Successful Iu connection release by CN for CS domain

- a) This measurement provides the number of successful release by a CS CN to an Iu connection between the RNC and a CS CN. The measurement is split into subcounters per release cause.
- b) CC
- c) Transmission of a RANAP message IU RELEASE COMPLETE by the RNC to the CS CN. Each RANAP message IU RELEASE COMPLETE sent to the CS CN is added to the relevant per cause measurement. The possible causes are included in TS 25.413 [5]. The sum of all supported per cause measurements shall equal the total number of IU RELEASE COMPLETE. In case only a subset of per cause measurements is supported, a sum measurement subtype will be provided first.
- d) Each measurement is an integer value. The number of measurements is equal to the number of causes plus a possible sum value identified by the *.sum* suffix.
- e) The measurement name has the form IU.SuccConnRelCNCS.*Cause* where *Cause* identifies the release cause.
- f) RncFunction
- g) Valid for circuit switching.
- h) UMTS

4.14.3.4 Successful Iu connection release by CN for PS domain

- a) This measurement provides the number of successful release by a PS CN to an Iu connection between the RNC and a PS CN. The measurement is split into subcounters per release cause.
- b) CC
- c) Transmission of a RANAP message IU RELEASE COMPLETE by the RNC to the PS CN. Each RANAP message IU RELEASE COMPLETE sent to the PS CN is added to the relevant per cause measurement. The possible causes are included in TS 25.413 [5]. The sum of all supported per cause measurements shall equal the total number of IU RELEASE COMPLETE. In case only a subset of per cause measurements is supported, a sum measurement subtype will be provided first.
- d) Each measurement is an integer value. The number of measurements is equal to the number of causes plus a possible sum value identified by the *.sum* suffix.
- e) The measurement name has the form IU.SuccConnRelCNPS.*Cause* where *Cause* identifies the release cause.
- f) RncFunction
- g) Valid for packet switching.
- h) UMTS

4.15 Intra-cell DCA

The three measurement types defined in subclause 4.15...n for Intra-cell DCA are subject to the "2 out of 3 approach".

4.15.1 Attempted intra-cell DCA

- a) This measurement provides the number of attempted intra-cell DCA per cell. This measurement is only valid for TDD mode.
- b) CC
- c) Transmission of a RRC message PHYSICAL CHANNEL RECONFIGURATION, RADIO BEARER SETUP, RADIO BEARER RECONFIGURATION, RADIO BEARER RELEASE, or TRANSPORT CHANNEL

RECONFIGURATION from the source RNC to the UE, indicating the attempt of an intra-cell DCA (see TS 25.331 [4]).

- d) A single integer value
- e) DCA.AttIntraCell.
- f) UtranCellTDDLcr
UtranCellTDDHcr
- g) Valid for circuit switched and packet switched traffic
- h) UMTS

4.15.2 Successful intra-cell DCA

- a) This measurement provides the number of successful intra-cell DCA per cell. This measurement is only valid for TDD mode.
- b) CC
- c) Receipt of a RRC message PHYSICAL CHANNEL RECONFIGURATION COMPLETE, RADIO BEARER SETUP COMPLETE, RADIO BEARER RECONFIGURATION COMPLETE, RADIO BEARER RELEASE COMPLETE, or TRANSPORT CHANNEL RECONFIGURATION COMPLETE sent from the UE to the source RNC, indicating a successful intra-cell DCA (see TS 25.331 [4]).
- d) A single integer value
- e) DCA.SuccIntraCell.
- f) UtranCellTDDLcr
UtranCellTDDHcr
- g) Valid for circuit switched and packet switched traffic
- h) UMTS

4.15.3 Failed intra-cell DCA

- a) This measurement provides the number of failed intra-cell DCA per cell per cause. This measurement is only valid for TDD mode.
- b) CC
- c) Receipt of a RRC message PHYSICAL CHANNEL RECONFIGURATION FAILURE, RADIO BEARER SETUP FAILURE, RADIO BEARER RECONFIGURATION FAILURE, RADIO BEARER RELEASE FAILURE, or TRANSPORT CHANNEL RECONFIGURATION FAILURE sent from the UE to the source RNC, indicating a failed intra-cell DCA. Failure causes are defined within TS 25.331 [4].

Each expected RRC message PHYSICAL CHANNEL RECONFIGURATION COMPLETE, RADIO BEARER SETUP COMPLETE, RADIO BEARER RECONFIGURATION COMPLETE, RADIO BEARER RELEASE COMPLETE, TRANSPORT CHANNEL RECONFIGURATION COMPLETE, PHYSICAL CHANNEL RECONFIGURATION FAILURE, RADIO BEARER SETUP FAILURE, RADIO BEARER RECONFIGURATION FAILURE, RADIO BEARER RELEASE FAILURE, or TRANSPORT CHANNEL RECONFIGURATION FAILURE not received by the source RNC is added to the measurement cause 'No Reply' (not specified in TS 25.331 [4]).

The sum of all supported per cause measurements shall equal the total number of failed events. In case only a subset of per cause measurements is supported, a sum subcounter will be provided first.

- d) Each measurement is an integer value. The number of measurements is equal to the number of causes supported plus a possible sum value identified by the *.sum* suffix.

- e) The measurement name has the form *DCA.FailIntraCell.Cause* where *Cause* identifies the failure cause. The cause 'No Reply' is identified by the *NoReply* suffix.
- f) UtranCellTDDLcr
UtranCellTDDHcr
- g) Valid for circuit switched and packet switched traffic
- h) UMTS

4.16 TDD Code Resources

4.16.1 UTRAN Cell Max Downlink Code Resources Used

- a) This measurement provides the number of OVSF codes used in the downlink of the UTRAN cell. This measurement is split into subcounters according to the Orthogonal Variable Spreading Factor (OVSF) length. This measurement is only valid for TDD mode.
- b) SI.
- c) This measurement is obtained by sampling at a pre-defined interval, the number of OVSF codes used per Spread Factor (SF), and then taking the arithmetic maximum. The SFs used are: SF= 1, SF= 16.
- d) Two integer values.
- e) TCR.DLCodeResUsed.SF1
TCR.DLCodeResUsed.SF16
- f) UtranCellTDDLcr
UtranCellTDDHcr
- g) UtranCell
- h) Valid for circuit switched and packet switched traffic
- i) UMTS

4.16.2 UTRAN Cell Max Uplink Code Resources Used

- a) This measurement provides the number of OVSF codes used in the uplink of the UTRAN cell. This measurement is split into subcounters according to the Orthogonal Variable Spreading Factor (OVSF) length. This measurement is only valid for TDD mode.
- b) SI.
- c) This measurement is obtained by sampling at a pre-defined interval, the number of OVSF codes used per Spread Factor (SF), and then taking the arithmetic maximum. The SFs used are: SF= 1, SF= 2, SF= 4, SF= 8, SF= 16.
- d) Five integer values.
- e) TCR.ULCodeResUsed.SF1
TCR.ULCodeResUsed.SF2
TCR.ULCodeResUsed.SF4
TCR.ULCodeResUsed.SF8
TCR.ULCodeResUsed.SF16.
- f) UtranCellTDDLcr
UtranCellTDDHcr
- g) Valid for circuit switched and packet switched traffic

- h) UMTS

4.16.3 Mean Downlink Code Resources Used of an UTRAN Cell

- a) This measurement provides the mean number of OVFS codes used in the downlink of the UTRAN cell. This measurement is split into subcounters according to the Orthogonal Variable Spreading Factor (OVFS) length. This measurement is only valid for TDD mode.
- b) SI.
- c) This measurement is obtained by sampling at a pre-defined interval, the number of OVFS codes used per spread factor (SF), and then taking the arithmetic mean. The SFs used are: SF= 1, SF= 16.
- d) Two integer values.
- e) TCR.DLMeanCodeResUsed.SF1,
TCR.DLMeanCodeResUsed.SF16.
- f) UtranCellTDDLcr
UtranCellTDDHcr
- g) Valid for circuit switched and packet switched traffic
- h) UMTS

4.16.4 Mean Uplink Code Resources Used of an UTRAN Cell

- a) This measurement provides the mean number of OVFS codes used in the uplink of the UTRAN cell. This measurement is split into subcounters according to the Orthogonal Variable Spreading Factor (OVFS) length. This measurement is only valid for TDD mode.
- b) SI.
- c) This measurement is obtained by sampling at a pre-defined interval, the number of OVFS codes used per Spread Factor (SF), and then taking the arithmetic mean. The SFs used are: SF= 1, SF= 2, SF= 4, SF= 8, SF= 16.
- d) Five integer values.
- e) TCR.ULMeanCodeResUsed.SF1,
TCR.ULMeanCodeResUsed.SF2,
TCR.ULMeanCodeResUsed.SF4,
TCR.ULMeanCodeResUsed.SF8,
TCR.ULMeanCodeResUsed.SF16.
- f) UtranCellTDDLcr
UtranCellTDDHcr
- g) Valid for circuit switched and packet switched traffic
- h) UMTS

4.17 Measurements related to TDD UTRAN cell Radio Frequency Carrier

4.17.1 Mean Transmitted Carrier Power of an UTRAN Cell

- a) This measurement provides the mean transmitted carrier power of an UTRAN cell. This measurement is only valid for TDD mode.
- b) SI.

- c) This measurement is obtained by sampling at a pre-defined interval, the transmitted carrier power of the same Node B reported, and then taking the arithmetic mean. For an Utran Cell in TDD mode, the minimum granularity for this measurement is a Time Slot (TS).
- d) In case a TS is configured to work for downlink, the measurement value for Transmitted Carrier Power on the basis of this TS is an integer, with a range from 0 to 100 that maps the value of the measured transmitted carrier power percentage as defined in table 9.46 of TS 25.123 [9]. When a TS is configured to work for uplink, the measurement for Transmitted Carrier Power on the basis of this TS is not valid and should have a NULL value specified in 3GPP TS 32.432 [12].
- e) CARR.MeanTSTCP.TS0,
CARR.MeanTSTCP.TS2,
CARR.MeanTSTCP.TS3,
CARR.MeanTSTCP.TS4,
CARR.MeanTSTCP.TS5,
CARR.MeanTSTCP.TS6.
- f) UtranCellTDDLcr
UtranCellTDDHcr
- g) Valid for circuit switched and packet switched traffic
- h) UMTS

4.17.2 Maximum Transmitted Carrier Power of an UTRAN Cell

- a) This measurement provides the maximum transmitted carrier power of an UTRAN cell. This measurement is only valid for TDD mode.
- b) SI.
- c) This measurement is obtained by sampling at a pre-defined interval, the transmitted carrier power of the same Node B reported, and then taking the maximum. For an Utran Cell in TDD mode, the minimum granularity for this measurement is a Time slot (TS).
- d) In case a TS is configured to work for downlink, the measurement value for Transmitted Carrier Power on the basis of this TS is an integer, with a range from 0 to 100, that maps the value of the measured transmitted carrier power percentage as defined in table 9.46 of TS 25.123 [9]. When a TS is configured to work for uplink, the measurement for Transmitted Carrier Power on the basis of this TS is not valid and should have a NULL value specified in 3GPP TS 32.432 [12].
- e) CARR.MaxTSTCP.TS0,
CARR.MaxTSTCP.TS2,
CARR.MaxTSTCP.TS3,
CARR.MaxTSTCP.TS4
CARR.MaxTSTCP.TS5
CARR.MaxTSTCP.TS6.
- f) UtranCellTDDLcr
UtranCellTDDHcr
- g) Valid for circuit switched and packet switched traffic
- h) UMTS

4.17.3 Mean Received Total Wideband Power of an UTRAN Cell

- a) This measurement provides the mean received total wide band power of an UTRAN cell. This measurement is only valid for TDD mode.
- b) SI.

- c) This measurement is obtained by sampling at a pre-defined interval, the received total wide band power of the same Node B reported, and then taking the arithmetic mean. For an Utran Cell in TDD mode, the minimum granularity for this measurement is a Time slot (TS).
- d) In case a TS is configured to work for downlink, the measurement value for Transmitted Carrier Power on the basis of this TS is an integer, with a range from 0 to 621 that maps the value of the received total wide band power percentage as defined in table 9.36 of TS 25.123 [9]. When a TS is configured to work for uplink, the measurement for Transmitted Carrier Power on the basis of this TS is not valid and should have a NULL value specified in 3GPP TS 32.432 [12].
- e) CARR.MeanTSRTWB.TS1,
CARR.MeanTSRTWP.TS2,
CARR.MeanTSRTWP.TS3,
CARR.MeanTSRTWP.TS4,
CARR.MeanTSRTWP.TS5,
CARR.MeanTSRTWP.TS6.
- f) UtranCellTDDLcr
UtranCellTDDHcr
- g) Valid for circuit switched and packet switched traffic
- h) UMTS

4.17.4 The Maximum Received Total Wideband Power of an UTRAN Cell

- a) This measurement provides the maximum received total wide band power of an UTRAN cell. This measurement is only valid for TDD mode.
- b) SI.
- c) This measurement is obtained by sampling at a pre-defined interval, the received total wide band power of the same Node B reported, and then taking the maximum. For an Utran Cell in TDD mode, the minimum granularity for this measurement is a Time Slot (TS).
- d) In case a TS is configured to work for downlink, the measurement value for Transmitted Carrier Power on the basis of this TS is an integer, with a range from 0 to 621, that maps the value of the received total wide band power percentage as defined in table 9.36 of TS 25.123 [9]. When a TS is configured to work for uplink, the measurement for Transmitted Carrier Power on the basis of this TS is not valid and should have a NULL value specified in 3GPP TS 32.432 [12].
- e) CARR.MaxTSRTWP.TS1,
CARR.MaxTSRTWP.TS2,
CARR.MaxTSRTWP.TS3,
CARR.MaxTSRTWP.TS4,
CARR.MaxTSRTWP.TS5,
CARR.MaxTSRTWP.TS6.
- f) UtranCellTDDLcr
UtranCellTDDHcr
- g) Valid for circuit switched and packet switched traffic
- h) UMTS

4.17.5 Mean DPCH Transmitted Code Power of an UTRAN Cell

- a) This measurement provides the mean of the DPCH Transmitted Code Power. This measurement is valid only for TDD mode.
- b) SI
- c) This measurement is obtained by sampling at a pre-defined interval, the DPCH Transmitted Code Power of a given UtranCell, and then taking the arithmetic mean.

- d) A single integer value from 10 to 122, that maps the value of the measured Transmitted Code Power as defined in table 9.49 of TS 25.123 [9].
- e) CARR. MeanDPCHTx
- f) UtranCellTDDLcr
UtranCellTDDHcr
- g) Valid for circuit switched and packet switched traffic
- h) UMTS

4.17.6 Maximum DPCH Transmitted Code Power of an UTRAN Cell

- a) This measurement provides the maximum of the DPCH Transmitted Code Power. This measurement is valid only for TDD mode.
- b) SI
- c) This measurement is obtained by sampling at a pre-defined interval, the DPCH Transmitted Code Power of a given UtranCell, and then taking the arithmetic maximum value.
- d) A single integer value from 10 to 122, that maps the value of the measured Transmitted Code Power as defined in table 9.49 of TS 25.123 [9].
- e) CARR. MaxDPCHTx
- f) UtranCellTDDLcr
UtranCellTDDHcr
- g) Valid for circuit switched and packet switched traffic
- h) UMTS

4.17.7 Mean DPCH Received Signal Code Power of an UTRAN Cell

- a) This measurement provides the mean of the DPCH Received Signal Code Power. This measurement is valid only for TDD mode.
- b) SI
- c) This measurement is obtained by sampling at a pre-defined interval, the DPCH Received Signal Code Power of a given UtranCell, and then taking the arithmetic mean.
- d) A single integer value from 10 to 122, that maps the value of the measured Received Signal Code Power as defined in table 9.49 of TS 25.123 [9].
- e) CARR. MeanDPCHR_x
- f) UtranCellTDDLcr
UtranCellTDDHcr
- g) Valid for circuit switched and packet switched traffic
- h) UMTS

4.17.8 Maximum DPCH Received Signal Code Power of an UTRAN Cell

- a) This measurement provides the maximum of the DPCH Received Signal Code Power. This measurement is valid only for TDD mode.
- b) SI
- c) This measurement is obtained by sampling at a pre-defined interval, the DPCH Received Signal Code Power of a given UtranCell, and then taking the arithmetic maximum value.

- d) A single integer value from 10 to 122, that maps the value of the measured Received Signal Code Power as defined in table 9.49 of TS 25.123 [9].
- e) CARR.MaxDPCHR_x
- f) UtranCellTDDLcr
UtranCellTDDHcr
- g) Valid for circuit switched and packet switched traffic
- h) UMTS

4.17.9 Mean Interference Signal Code Power of an UTRAN Cell

- a) This measurement provides the mean interference signal code power of an UTRAN cell in uplink. This measurement is only valid for TDD mode.
- b) SI
- c) This measurement is obtained by sampling at a pre-defined interval, the interference signal code power of the same Node B reported, and then taking the arithmetic mean. For an Utran Cell in TDD mode, the minimum granularity for this measurement is a Time Slot (TS).
- d) In case a TS is configured to work for uplink, the measurement value for interference signal code power on the basis of this TS is an integer value, with a range from 0 to 91 that maps the value of the interference signal code power as defined in table 9.10 of TS 25.123 [9]. When a TS is configured to work for downlink, the measurement for interference signal code power on the basis of this TS is not valid and should have a NULL value specified in 3GPP TS 32.432 [12].
- e) CARR.MeanTSISCP.TS1,
CARR.MeanTSISCP.TS2,
CARR.MeanTSISCP.TS3,
CARR.MeanTSISCP.TS4,
CARR.MeanTSISCP.TS5,
CARR.MeanTSISCP.TS6.
- f) UtranCellTDDLcr
UtranCellTDDHcr
- g) Valid for circuit switched and packet switched traffic
- h) UMTS

4.17.10 Maximum Interference Signal Code Power of an UTRAN Cell

- a) This measurement provides the maximum interference signal code power of an UTRAN cell in uplink. This measurement is only valid for TDD mode.
- b) SI
- c) This measurement is obtained by sampling at a pre-defined interval, the interference signal code power of the same Node B reported, and then taking the maximum. For an Utran Cell in TDD mode, the minimum granularity for this measurement is a Time Slot (TS).
- d) In case a TS is configured to work for uplink, the measurement value for interference signal code power on the basis of this TS is an integer value, with a range from 0 to 91 that maps the value of the interference signal code power as defined in table 9.10 of TS 25.123 [9]. When a TS is configured to work for downlink, the measurement for interference signal code power on the basis of this TS is not valid and should have a NULL value specified in 3GPP TS 32.432 [12].
- e) CARR.MaxTSISCP.TS1,
CARR.MaxTSISCP.TS2,
CARR.MaxTSISCP.TS3,
CARR.MaxTSISCP.TS4,

CARR.MaxTSISCP.TS5,
CARR.MaxTSISCP.TS6.

- f) UtranCellTDDLcr
UtranCellTDDHcr
- g) Valid for circuit switched and packet switched traffic
- h) UMTS

4.17.11 Mean transmitted carrier power of all codes not used for HS-PDSCH or HS-SCCH transmission

- a) This measurement provides the mean transmitted non-HS carrier power of a serving HS-DSCH cell. This measurement is valid only for TDD mode.
- b) SI
- c) This measurement is obtained by sampling at a pre-defined interval, the transmitted carrier power (extracted from NBAP common measurement report (see TS 25.225 [16], TS 25.433 [7])) of all codes not used for HS-PDSCH or HS-SCCH transmission of a given UtranCell, and then taking the arithmetic mean of the measurement values obtained during the granularity period. For an UTRAN cell in TDD mode, the minimum granularity of this measurement is a Time Slot (TS).
- d) In case a TS is configured to work for downlink, the measurement value for transmitted carrier power on the basis of this TS is an integer value, with a range from 0 to 100 that maps the value of the transmitted carrier power as defined in table 9.51 of TS 25.123 [9]. When a TS is configured to work for uplink, the measurement for transmitted carrier power on the basis of this TS is not valid and should have a NULL value specified in 3GPP TS 32.432 [15].
- e) CARR.MeanTDDNonHSTCP.TS0,
CARR.MeanTDDNonHSTCP.TS2,
CARR.MeanTDDNonHSTCP.TS3,
CARR.MeanTDDNonHSTCP.TS4,
CARR.MeanTDDNonHSTCP.TS5,
CARR.MeanTDDNonHSTCP.TS6.
- f) UtranCellTDDLcr
UtranCellTDDHcr
- g) Valid only for packet switched traffic
- h) UMTS

4.17.12 Maximum transmitted carrier power of all codes not used for HS-PDSCH or HS-SCCH transmission

- a) This measurement provides the maximum transmitted non-HS carrier power of a serving HS-DSCH cell. This measurement is valid only for TDD mode.
- b) SI
- c) This measurement is obtained by sampling at a pre-defined interval, the transmitted carrier power (extracted from NBAP common measurement report (see TS 25.225 [16], TS 25.433 [7])) of all codes not used for HS-PDSCH or HS-SCCH transmission of a given UtranCell, and then taking the arithmetic maximum of the measurement values obtained during the granularity period. For an UTRAN cell in TDD mode, the minimum granularity of this measurement is a Time Slot (TS).
- d) In case a TS is configured to work for downlink, the measurement value for transmitted carrier power on the basis of this TS is an integer value, with a range from 0 to 100 that maps the value of the transmitted carrier power as defined in table 9.51 of TS 25.123 [9]. When a TS is configured to work for uplink, the measurement for transmitted carrier power on the basis of this TS is not valid and should have a NULL value specified in 3GPP TS 32.432 [15].

- e) CARR.MaxTDDNonHSTCP.TS0,
CARR.MaxTDDNonHSTCP.TS2,
CARR.MaxTDDNonHSTCP.TS3,
CARR.MaxTDDNonHSTCP.TS4,
CARR.MaxTDDNonHSTCP.TS5,
CARR.MaxTDDNonHSTCP.TS6.
- f) UtranCellTDDLcr
UtranCellTDDHcr
- g) Valid only for packet switched traffic
- h) UMTS

4.18 Measurements related to the UTRAN cell FDD carrier (RF Performance metrics)

RF metrics can be used to indicate loading levels and abnormal conditions.

4.18.1 Mean Transmitted Carrier Power of an UTRAN Cell

- a) This measurement provides the average of the transmitted carrier power. This measurement is valid only for FDD mode.
- b) SI.
- c) This measurement is obtained by sampling at a pre-defined interval, the transmitted carrier power (see TS 25.133 [8]) for the RF carrier of a given UtranCell, and then taking the arithmetic mean.
- d) A single integer value from 0 to 100, that maps the value of the measured transmitted carrier power percentage as defined in table 9.43 [8].
- e) CARR.FDDMeanTCP.
- f) UtranCellFDD
- g) Valid for circuit switched and packet switched traffic
- h) UMTS
- i) Network Operator's Traffic Engineering Community, Equipment Vendor's Performance Modelling Community.

4.18.2 Maximum Transmitted Carrier Power of an UTRAN Cell

- a) This measurement provides the maximum of the transmitted carrier power. This measurement is valid only for FDD mode.
- b) SI.
- c) This measurement is obtained by sampling at a pre-defined interval, the transmitted carrier power (see TS 25.133 [8]) for the RF carrier of a given UtranCell, and then taking the maximum value.
- d) A single integer value from 0 to 100, that maps the value of the measured transmitted carrier power percentage as defined in table 9.43 [8].
- e) CARR.FDDMaxTCP.
- f) UtranCellFDD
- g) Valid for circuit switched and packet switched traffic
- h) UMTS

- i) Network Operator's Traffic Engineering Community, Equipment Vendor's Performance Modelling Community.

4.18.3 Mean Received Total Wideband Power of an UTRAN Cell

- a) This measurement provides the average of the received total wideband power. This measurement is valid only for FDD mode.
- b) SI.
- c) This measurement is obtained by sampling at a pre-defined interval, the received total wideband power (see TS 25.133 [8]) for the RF carrier of a given UtranCell, and then taking the arithmetic mean.
- d) A single integer value from 0 to 621 that maps the value of the measured received total wideband power as defined In table 9.37[8].
- e) CARR.FDDMeanRTWP.
- f) UtranCellFDD
- g) Valid for circuit switched and packet switched traffic
- h) UMTS
- i) Network Operator's Traffic Engineering Community, Equipment Vendor's Performance Modelling Community.

4.18.4 Maximum Received Total Wideband Power of an UTRAN Cell

- a) This measurement provides the maximum of the received total wideband power. This measurement is valid only for FDD mode.
- b) SI.
- c) This measurement is obtained by sampling at a pre-defined interval, the received wideband power (see TS 25.133 [8]) for the RF carrier of a given UtranCell, and then taking the maximum value.
- d) A single integer value from 0 to 621 that maps the value of the measured received total wideband power as defined In table 9.37[8]
- e) CARR.FDDMaxRTWP.
- f) UtranCellFDD
- g) Valid for circuit switched and packet switched traffic
- h) UMTS
- i) Network Operator's Traffic Engineering Community, Equipment Vendor's Performance Modelling Community.

4.18.5 Mean Radio Link Transmitted Code Power of an UTRAN Cell

- a) This measurement provides the average of the Radio Link Transmitted Code Power. This measurement is valid for only FDD mode.
- b) SI
- c) This measurement is obtained by sampling at a pre-defined interval, the Radio Link Transmitted Code Power of a given UtranCell, and then taking the arithmetic mean.
- d) A single integer value from 10 to 122, that maps the value of the measured Transmitted Code Power as defined in table 9.46 of TS 25.133 [8].
- e) CARR. MeanRadioLink
- f) UtranCellFDD

- g) Valid for circuit switched and packet switched traffic
- h) UMTS

4.18.6 Maximum Radio Link Transmitted Code Power of an UTRAN Cell

- a) This measurement provides the maximum of the Radio Link Transmitted Code Power. This measurement is valid only for FDD mode.
- b) SI
- c) This measurement is obtained by sampling at a pre-defined interval, the Radio Link Transmitted Code Power of a given UtranCell, and then taking the arithmetic maximum value.
- d) A single integer value from 10 to 122, that maps the value of the measured Transmitted Code Power as defined in table 9.46 of TS 25.133 [8].
- e) CARR.MaxRadioLink
- f) UtranCellFDD
- g) Valid for circuit switched and packet switched traffic
- h) UMTS

4.18.7 Mean transmitted carrier power of all codes not used for HS-PDSCH, HS-SCCH, E-AGCH, E-RGCH or E-HICH transmission of an UTRAN Cell

- a) This measurement provides the mean transmitted non-HS carrier power of a serving HS-DSCH cell. This measurement is valid only for FDD mode.
- b) SI.
- c) This measurement is obtained by sampling at a pre-defined interval, the transmitted carrier power (extracted from NBAP common measurement report (see TS 25.215 [14], TS 25.433 [7])) of all codes not used for HS-PDSCH, HS-SCCH, E-AGCH, E-RGCH or E-HICH transmission of a given UtranCell, and then taking the arithmetic mean of the measurement values obtained during the granularity period.
- d) A single integer value from 0 to 100, that maps the value of the measured transmitted carrier power to a percentage as defined in table 9.64 (see TS 25.133 [8]).
- e) CARR.MeanFDDNonHSTCP.
- f) UtranCellFDD
- g) Valid for circuit switched and packet switched traffic
- h) UMTS

4.18.8 Maximum transmitted carrier power of all codes not used for HS-PDSCH, HS-SCCH, E-AGCH, E-RGCH or E-HICH transmission of an UTRAN Cell

- a) This measurement provides the maximum transmitted non-HS carrier power of a serving HS-DSCH cell. This measurement is valid only for FDD mode.
- b) SI.
- c) This measurement is obtained by sampling at a pre-defined interval, the transmitted carrier power (extracted from NBAP common measurement report (see TS 25.215 [14], TS 25.433 [7])) of all codes not used for HS-

PDSCH, HS-SCCH, E-AGCH, E-RGCH or E-HICH transmission of a given UtranCell, and then taking the maximum of the measurement values obtained during the granularity period.

- d) A single integer value from 0 to 100, that maps the value of the measured transmitted carrier power to a percentage as defined in table 9.64 (see TS 25.133 [8]).
- e) CARR.MaxFDDNonHSTCP.
- f) UtranCellFDD
- g) Valid for circuit switched and packet switched traffic
- h) UMTS

4.19 FDD Code Resources

4.19.1 Code Resources Used of an FDD mode UTRAN Cell

- a) This measurement provides the number of OVFSF codes used of an UTRAN cell. This measurement is split into subcounters according to the Orthogonal Variable Spreading Factor (OVFSF) length. This measurement is only valid for FDD mode.
- b) SI.
- c) This measurement is obtained by sampling at a pre-defined interval, the number of OVFSF codes used per spread factor (SF), and then taking the arithmetic mean. The SF used as following:
SF=4, SF= 8, SF= 16, SF= 32, SF= 64, SF= 128, SF= 256, SF=512.
- d) Eight integer values.
- e) CR.CodesUsed.SF4
CR.CodesUsed.SF8
CR.CodesUsed.SF16
CR.CodesUsed.SF32
CR.CodesUsed.SF64
CR.CodesUsed.SF128
CR.CodesUsed.SF256
CR.CodesUsed.SF512
- f) UtranCellFDD
- g) Valid for circuit switched and packet switched traffic
- h) UMTS

4.20 Paging

4.20.1 Overview

Paging procedures include RANAP Paging procedure, RRC Paging and RRC UE Dedicated Paging procedure.

4.20.1.1 Considered Paging procedures

Performance Measurement definitions in this subclause are based on TS 25.331 [4] and TS 25.413 [5].

The following procedures are of interest for this purpose:

RRC: UE DEDICATED PAGING

RRC: PAGING

RANAP: PAGING

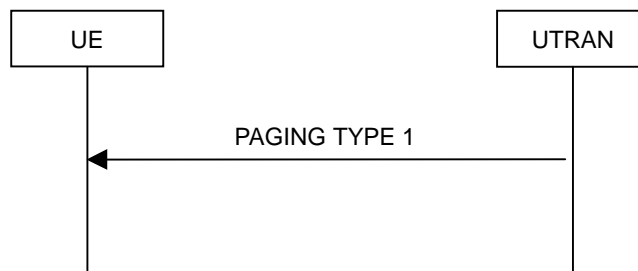

Figure: RRC Paging procedure

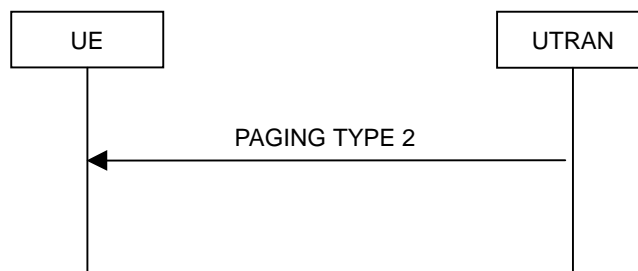

Figure: RRC UE Dedicated Paging procedure



Figure: RANAP Paging procedure (Successful operation)

4.20.2 Paging request from CN

- a) This measurement provides the number of paging requests received from CN. The measurement is split into subcounters per paging cause.
- b) CC
- c) On receipt by the RNC of a RANAP PAGING message from CN. Each RANAP message PAGING receipt by the RNC is added to the relevant per cause measurement. The possible causes are included in TS 25.413 [5]. The sum of all supported per cause measurements shall equal the total number of PAGING requests. In case only a subset of per cause measurements is supported, a sum measurement subtype will be provided first.
- d) Each measurement is an integer value.
- e) The measurement name has the form *Pag.AttCn.Cause* where *Cause* identifies the paging cause.
- f) RncFunction
- g) Valid for circuit switched and packet switched traffic
- h) UMTS

4.20.3 Paging Type 1

4.20.3.1 Attempted Paging Type 1

- a) This measurement provides the number of attempted Paging Type 1 procedures. The measurement is split into subcounters per paging cause.
- b) CC
- c) On transmission by the RNC of a RRC PAGING TYPE 1 message to the UE. Each RRC PAGING TYPE 1 message sent by the RNC is added to the relevant per cause measurement. The possible causes are included in TS 25.331 [4]. The sum of all supported per cause measurements shall equal the total number of Paging Type 1 attempts. In case only a subset of per cause measurements is supported, a sum measurement subtype will be provided first.
- d) Each measurement is an integer value.
- e) The measurement name has the form *Pag.AttPagType1.Cause* where *Cause* identifies the paging cause.
- f) UtranCellFDD
UtranCellTDDLcr
UtranCellTDDHcr
- g) Valid for circuit switched and packet switched traffic
- h) UMTS

4.20.4 Paging Type 2

4.20.4.1 Attempted Paging Type 2

- a) This measurement provides the number of attempted Paging Type 2 procedures. The measurement is split into subcounters per paging cause.
- b) CC
- c) On transmission by the RNC of a RRC PAGING TYPE 2 message to the UE. Each RRC PAGING TYPE 2 message sent by the RNC is added to the relevant per cause measurement. The possible causes are included in TS 25.331 [4]. The sum of all supported per cause measurements shall equal the total number of Paging Type 2 attempts. In case only a subset of per cause measurements is supported, a sum measurement subtype will be provided first.
- d) Each measurement is an integer value.
- e) The measurement name has the form *Pag.AttPagType2.Cause* where *Cause* identifies the paging cause.
- f) UtranCellFDD
UtranCellTDDLcr
UtranCellTDDHcr
- g) Valid for circuit switched and packet switched traffic

- h) UMTS

4.21 ATM layer measurement

4.21.1 Cell collection

4.21.1.1 Ingress cells (whole stream)

- a) This measurement provides the total number of ingress cells on ATM node.
- b) CC
- c) See clause 5.6.7 in [11].
- d) A single integer value, see [11].
- e) ATM.ATML.IngressCells.
- f) IubLink.
- g) Valid for circuit switched and packet switched traffic
- h) UMTS

4.21.1.2 Egress cells (whole stream)

- a) This measurement provides the total number of egress cells on ATM node.
- b) CC
- c) See NumberCellsTrnsd in [11].
- d) A single integer value, see [11].
- e) ATM.ATML.EgressCells.
- f) IubLink.
- g) Valid for circuit switched and packet switched traffic
- h) UMTS

4.22 HSDPA setup

4.22.1 Mac-d setup for HSDPA

The three measurement types defined in this subclause are subject to the "2 out of 3 approach".

4.22.1.1 Attempted Mac-d setups for HSDPA

- a) This measurement provides the number of attempted Mac-d setups for HSDPA.
- b) CC
- c) On transmission by the RNC of a NBAP message RADIO LINK SETUP REQUEST with the "HS-DSCH Information" IE; Or on transmission by the RNC of a NBAP message RADIO LINK RECONFIGURATION PREPARE with the "HS-DSCH MAC-d Flows To Add" or "HS-DSCH Information" IE; Or on transmission by the RNC of a NBAP message RADIO LINK RECONFIGURATION REQUEST with the "HS-DSCH MAC-d Flows To Add" or "HS-DSCH Information" IE. See TS 25.433 [7].
- d) A single integer value

- e) HSDPA.AttMacdSetup
- f) UtranCellFDD
UtranCellTDDLcr
UtranCellTDDHcr
- g) Valid for packet switched traffic
- h) UMTS

4.22.1.2 Successful Mac-d setups for HSDPA

- a) This measurement provides the number of successful Mac-d setups for HSDPA.
- b) CC
- c) On receipt by the RNC of a NBAP message RADIO LINK SETUP RESPONSE, corresponding to transmission of the NBAP message RADIO LINK SETUP REQUEST with the “HS-DSCH Information” IE; Or on receipt by the RNC of a NBAP message RADIO LINK RECONFIGURATION READY, corresponding to the transmission of the NBAP message RADIO LINK RECONFIGURATION PREPARE with the “HS-DSCH MAC-d Flows To Add” or “HS-DSCH Information” IE; Or on receipt by the RNC of NBAP message RADIO LINK RECONFIGURATION RESPONSE, corresponding to the transmission of the NBAP message RADIO LINK RECONFIGURATION REQUEST with the “HS-DSCH MAC-d Flows To Add” or “HS-DSCH Information” IE. See TS 25.433 [7].
- d) A single integer value
- e) HSDPA.SuccMacdSetup
- f) UtranCellFDD
UtranCellTDDLcr
UtranCellTDDHcr
- g) Valid for packet switched traffic
- h) UMTS

4.22.1.3 Failed Mac-d setups for HSDPA

- a) This measurement provides the number of failed Mac-d setups for HSDPA. The measurement is split into subcounters per cause.
- b) CC
- c) On receipt by the RNC of a NBAP message RADIO LINK SETUP FAILURE, corresponding to transmission of the NBAP message RADIO LINK SETUP REQUEST with the “HS-DSCH Information” IE; Or on receipt by the RNC of a NBAP message RADIO LINK RECONFIGURATION FAILURE, corresponding to the transmission of the NBAP message RADIO LINK RECONFIGURATION PREPARE with the “HS-DSCH MAC-d Flows To Add” or “HS-DSCH Information” IE; Or on receipt by the RNC of NBAP message RADIO LINK RECONFIGURATION FAILURE, corresponding to the transmission of the NBAP message RADIO LINK RECONFIGURATION REQUEST with the “HS-DSCH MAC-d Flows To Add” or “HS-DSCH Information” IE. Each failed Mac-d setup for HSDPA is added to the relevant measurement according to the failure cause. Possible failure causes are included in TS 25.433 [7].

Each expected NBAP message RADIO LINK SETUP FAILURE, corresponding to transmission of the NBAP message RADIO LINK SETUP REQUEST with the “HS-DSCH Information” IE; Or NBAP message RADIO LINK RECONFIGURATION FAILURE, corresponding to the transmission of the NBAP message RADIO LINK RECONFIGURATION PREPARE with the “HS-DSCH MAC-d Flows To Add” or “HS-DSCH Information” IE; Or NBAP message RADIO LINK RECONFIGURATION FAILURE, corresponding to the transmission of the NBAP message RADIO LINK RECONFIGURATION REQUEST with the “HS-DSCH MAC-d Flows To Add” or “HS-DSCH Information” IE not received by the RNC is added to the measurement cause 'No Reply' (not specified in TS 25.433 [7]).

The sum of all supported per cause measurements shall equal the total number of failed Mac-d setups for HSDPA. In case only a subset of per cause measurements is supported, a sum subcounter will be provided first.

- d) Each measurement is an integer value. The number of measurements is equal to the number of causes plus a possible sum value identified by the *.sum* suffix.
- e) The measurement name has the form HSDPA.FailMacdSetup.*Cause* where *Cause* identifies the failure cause. The cause 'No Reply' is identified by the *.NoReply* suffix.
- f) UtranCellFDD
UtranCellTDDLcr
UtranCellTDDHcr
- g) Valid for packet switched traffic
- h) UMTS

4.22.2 RB setup for HSDPA

The three measurement types defined in this subclause are subject to the "2 out of 3 approach".

4.22.2.1 Attempted RB setups for HSDPA

- a) This measurement provides the number of attempted radio bearer setups for HSDPA.
- b) CC
- c) On transmission by the RNC of a RRC message RADIO BEARER SETUP with the "Downlink transport channel type" set to "HS-DSCH" or "DCH + HS-DSCH" in the "RB mapping info" IE of the "RB information to setup"; Or on transmission by the RNC of a RRC message RADIO BEARER RECONFIGURATION with "Downlink transport channel type" set to "HS-DSCH" or "DCH + HS-DSCH" in the "RB mapping info" IE of the "RB information to reconfigure" if the previous "Downlink transport channel type" of this RB is not the "HS-DSCH" or "DCH + HS-DSCH". See TS 25.331 [4].
- d) A single integer value
- e) HSDPA.AttRBSetup
- f) UtranCellFDD
UtranCellTDDLcr
UtranCellTDDHcr
- g) Valid for packet switched traffic
- h) UMTS

4.22.2.2 Successful RB setups for HSDPA

- a) This measurement provides the number of successful radio bearer setups for HSDPA.
- b) CC
- c) On receipt by the RNC of a RRC message RADIO BEARER SETUP COMPLETE, corresponding to the transmission of the RRC message RADIO BEARER SETUP with the "Downlink transport channel type" set to "HS-DSCH" or "DCH + HS-DSCH" in the "RB mapping info" IE of the "RB information to setup"; Or on receipt by the RNC of a RRC message RADIO BEARER RECONFIGURATION COMPLETE, corresponding to the transmission of the RRC message RADIO BEARER RECONFIGURATION with "Downlink transport channel type" set to "HS-DSCH" or "DCH + HS-DSCH" in the "RB mapping info" IE of the "RB information to reconfigure" if the previous "Downlink transport channel type" of this RB is not the "HS-DSCH" or "DCH + HS-DSCH". See TS 25.331 [4].
- d) A single integer value

- e) HSDPA.SuccRBSetup
- f) UtranCellFDD
UtranCellTDDLcr
UtranCellTDDHcr
- g) Valid for packet switched traffic
- h) UMTS

4.22.2.3 Failed RB setups for HSDPA

- a) This measurement provides the number of failed radio bearer setups for HSDPA. The measurement is split into subcounters per cause.
- b) CC
- c) On receipt by the RNC of a RRC message RADIO BEARER SETUP FAILURE, corresponding to the transmission of the RRC message RADIO BEARER SETUP with the “Downlink transport channel type” set to “HS-DSCH” or “DCH + HS-DSCH” in the “RB mapping info” IE of the “RB information to setup”; Or on receipt by the RNC of a RRC message RADIO BEARER RECONFIGURATION FAILURE, corresponding to the transmission of the RRC message RADIO BEARER RECONFIGURATION with “Downlink transport channel type” set to “HS-DSCH” or “DCH + HS-DSCH” in the “RB mapping info” IE of the “RB information to reconfigure” if the previous “Downlink transport channel type” of this RB is not the “HS-DSCH” or “DCH + HS-DSCH”. Each failed RB setup for HSDPA is added to the relevant measurement according to the failure cause. Possible failure causes are included in TS 25.331 [4].

Each expected RRC message RADIO BEARER SETUP FAILURE, corresponding to the transmission of the RRC message RADIO BEARER SETUP with the “Downlink transport channel type” set to “HS-DSCH” or “DCH + HS-DSCH” in the “RB mapping info” IE of the “RB information to setup”; Or RRC message RADIO BEARER RECONFIGURATION FAILURE, corresponding to the transmission of the RRC message RADIO BEARER RECONFIGURATION with “Downlink transport channel type” set to “HS-DSCH” or “DCH + HS-DSCH” in the “RB mapping info” IE of the “RB information to reconfigure” if the previous “Downlink transport channel type” of this RB is not the “HS-DSCH” or “DCH + HS-DSCH” not received by the RNC is added to the measurement cause 'No Reply' (not specified in TS 25.331 [4]).

The sum of all supported per cause measurements shall equal the total number of failed RB setups for HSDPA. In case only a subset of per cause measurements is supported, a sum subcounter will be provided first.

- d) Each measurement is an integer value. The number of measurements is equal to the number of causes plus a possible sum value identified by the .sum suffix.
- e) The measurement name has the form HSDPA.FailRBSetup.Cause where *Cause* identifies the failure cause. The cause 'No Reply' is identified by the *NoReply* suffix.
- f) UtranCellFDD
UtranCellTDDLcr
UtranCellTDDHcr
- g) Valid for packet switched traffic
- h) UMTS

4.23 Call duration in UTRAN cell

4.23.1 Call duration in UTRAN cell for CS domain

- a) This measurement provides the call duration in utran cell for CS domain. The measurement is split into subcounters per traffic class (See the 3GPP TS23.107 [2]).
- b) DER (n=1)

- c) This measurement is obtained by accumulating the time intervals for each traffic class between the call start RRC RADIO BEARER SETUP COMPLETE and the call completed RRC RADIO BEARER RELEASE over a granularity period using DER. For conversational service, the relevant measurement for each specified data rate is required, the detailed data rates are listed below (see TS 25.993 [12]). The accumulator shall be reinitialised at the beginning of each granularity period. The call duration for each traffic class (for each specified data rate of conversational service) for CS domain is added to the relevant measurement. See TS 25.413 [5] and TS 23.107 [2].

uplink <U>:

- 1: AMR rate (12.2 10.2 7.95 7.4 6.7 5.9 5.15 4.75) kbps
- 2: 12.2 kbps
- 3: 28.8 kbps
- 4: 32 kbps
- 5: 64 kbps

downlink <D>:

- 1: AMR rate (12.2 10.2 7.95 7.4 6.7 5.9 5.15 4.75) kbps
- 2: 12.2 kbps
- 3: 28.8 kbps
- 4: 32 kbps
- 5: 64 kbps

As indicated above, <U> and <D> are integer values that map to the conversational service specified uplink and downlink data rates, respectively.

- d) Each measurement is an integer value. (in seconds)
- e) The measurement name has the form
RRC.CallDurationCS.Conv.<U><D>
RRC.CallDurationCS.Strm
RRC.CallDurationCS.Intact
RRC.CallDurationCS.Bgrd.
- f) UtranCellFDD
UtranCellTDDLcr
UtranCellTDDHcr
- g) Valid for circuit switched
- h) UMTS

4.24 Measurements related to channel switches between FACH/DCH and HS-DSCH

4.24.1 Measurements related to channel switches from FACH/DCH to HS-DSCH intra UTRAN cell

4.24.1.1 Attempted channel switches from FACH to HS-DSCH

- a) This measurement provides the number of attempted channel switches from FACH to HS-DSCH in the serving HS-DSCH cell.
- b) CC
- c) On transmission by the RNC of a RRC message RADIO BEARER RECONFIGURATION to UE, with the condition that channel switches from FACH to HS-DSCH (see TS 25.331 [4]).

NOTE: This measurement is dedicated to channel switches from FACH to HS-DSCH.

- d) A single integer value
- e) HSDPA.AttFachToHs

- f) UtranCellFDD
UtranCellTDDLcr
UtranCellTDDHcr
- g) Valid for packet switched traffic
- h) UMTS

4.24.1.2 Successful channel switches from FACH to HS-DSCH

- a) This measurement provides the number of successful channel switches from FACH to HS-DSCH in the serving HS-DSCH cell.
- b) CC
- c) On receipt by the RNC of a RRC message RADIO BEARER RECONFIGURATION COMPLETE from UE, with the condition that channel switches from FACH to HS-DSCH (see TS 25.331 [4]).

NOTE: This measurement is dedicated to channel switches from FACH to HS-DSCH.

- d) A single integer value
- e) HSDPA.SuccFachToHs
- f) UtranCellFDD
UtranCellTDDLcr
UtranCellTDDHcr
- g) Valid for packet switched traffic
- h) UMTS

4.24.1.3 Attempted channel switches from DCH to HS-DSCH

- a) This measurement provides the number of attempted channel switches from DCH to HS-DSCH in the serving HS-DSCH cell.
- b) CC
- c) On transmission by the RNC of a RRC message RADIO BEARER RECONFIGURATION to UE, with the condition that channel switches from DCH to HS-DSCH (see TS 25.331 [4]).

- d) A single integer value
- e) HSDPA.AttDchToHs
- f) UtranCellFDD
UtranCellTDDLcr
UtranCellTDDHcr
- g) Valid for packet switched traffic
- h) UMTS

4.24.1.4 Successful channel switches from DCH to HS-DSCH

- a) This measurement provides the number of successful channel switches from DCH to HS-DSCH in the serving HS-DSCH cell.
- b) CC
- c) On receipt by the RNC of a RRC message RADIO BEARER RECONFIGURATION COMPLETE from UE, with the condition that channel switches from DCH to HS-DSCH (see TS 25.331 [4]).
- d) A single integer value

- e) HSDPA.SuccDchToHs
- f) UtranCellFDD
UtranCellTDDLcr
UtranCellTDDHcr
- g) Valid for packet switched traffic
- h) UMTS

4.24.2 Measurements related to channel switches from HS-DSCH to FACH/DCH intra UTRAN cell

4.24.2.1 Attempted channel switches from HS-DSCH to FACH

- a) This measurement provides the number of attempted channel switches from HS-DSCH to FACH in the serving HS-DSCH cell.
- b) CC
- c) On transmission by the RNC of a RRC message RADIO BEARER RECONFIGURATION to UE, with the condition that channel switches from HS-DSCH to FACH (see TS 25.331 [4]).

Note: this measurement is dedicated to channel switches from HS-DSCH to FACH.

- d) A single integer value
- e) HSDPA.AttHsToFach
- f) UtranCellFDD
UtranCellTDDLcr
UtranCellTDDHcr
- g) Valid for packet switched traffic
- h) UMTS

4.24.2.2 Successful channel switches from HS-DSCH to FACH

- a) This measurement provides the number of successful channel switches from HS-DSCH to FACH in the serving HS-DSCH cell.
- b) CC
- c) On receipt by the RNC of a RRC message RADIO BEARER RECONFIGURATION COMPLETE from UE, with the condition that channel switches from HS-DSCH to FACH (see TS 25.331 [4]).

Note: this measurement is dedicated to channel switches from HS-DSCH to FACH.

- d) A single integer value
- e) HSDPA.SuccHsToFach
- f) UtranCellFDD
UtranCellTDDLcr
UtranCellTDDHcr
- g) Valid for packet switched traffic
- h) UMTS

4.24.2.3 Attempted channel switches from HS-DSCH to DCH

- a) This measurement provides the number of attempted channel switches from HS-DSCH to DCH in the serving HS-DSCH cell.
- b) CC
- c) On transmission by the RNC of a RRC message RADIO BEARER RECONFIGURATION to UE, with the condition that channel switches from HS-DSCH to DCH (see TS 25.331 [4]).
- d) A single integer value
- e) HSDPA.AttHsToDch
- f) UtranCellFDD
UtranCellTDDLcr
UtranCellTDDHcr
- g) Valid for packet switched traffic
- h) UMTS

4.24.2.4 Successful channel switches from HS-DSCH to DCH

- a) This measurement provides the number of successful channel switches from HS-DSCH to DCH in the serving HS-DSCH cell.
- b) CC
- c) On receipt by the RNC of a RRC message RADIO BEARER RECONFIGURATION COMPLETE from UE, with the condition that channel switches from HS-DSCH to DCH (see TS 25.331 [4]).
- d) A single integer value
- e) HSDPA.SuccHsToDch
- f) UtranCellFDD
UtranCellTDDLcr
UtranCellTDDHcr
- g) Valid for packet switched traffic
- h) UMTS

4.25 HSDPA mobility related measurements

4.25.1 Serving HS-DSCH cell change

4.25.1.1 Attempted serving HS-DSCH cell changes

- a) This measurement provides the number of attempted serving HS-DSCH cell changes.
- b) CC
- c) On transmission by the RNC of a RRC message PHYSICAL CHANNEL RECONFIGURATION, RADIO BEARER SETUP, RADIO BEARER RECONFIGURATION, RADIO BEARER RELEASE, or TRANSPORT CHANNEL RECONFIGURATION from the source RNC to the UE, also the target cell is different with source cell, indicating the attempt of serving HS-DSCH cell change (see TS 25.331 [4]).
- d) A single integer value
- e) HSDPA.AttCellChange

- f) UtranCellFDD
UtranCellTDDLcr
UtranCellTDDHcr
- g) Valid for packet switched traffic
- h) UMTS

4.25.1.2 Successful serving HS-DSCH cell changes

- a) This measurement provides the number of successfully performed serving HS-DSCH cell changes.
- b) CC
- c) On receipt by the RNC of a RRC message PHYSICAL CHANNEL RECONFIGURATION COMPLETE, RADIO BEARER SETUP COMPLETE, RADIO BEARER RECONFIGURATION COMPLETE, RADIO BEARER RELEASE COMPLETE, or TRANSPORT CHANNEL RECONFIGURATION COMPLETE sent from the UE to the source RNC, also the target cell is different with source cell indicating a successful serving HS-DSCH cell change (see TS 25.331 [4]).
- d) A single integer value
- e) HSDPA.SuccCellChange
- f) UtranCellFDD
UtranCellTDDLcr
UtranCellTDDHcr
- g) Valid for packet switched traffic
- h) UMTS

4.26 Measurements related to MAC-hs

4.26.1 Measurements related to MAC-hs feedback decoding

4.26.1.1 Number of acknowledged transmitted MAC-hs PDUs

- a) This measurement provides the number of acknowledged transmitted MAC-hs PDUs during the period of measurement, detected in MAC-hs layer in the serving HS-DSCH cell.
- b) CC.
- c) On receipt by the NodeB of a PDU acknowledged by ACK message of MAC-hs from UE.
- d) A single integer value.
- e) HSDPA.NbrAckdMachsPdu
- f) UtranCellFDD
UtranCellTDDLcr
UtranCellTDDHcr
- g) Valid for packet switched traffic.
- h) UMTS.

4.26.1.2 Number of transmitted MAC-hs PDUs

- a) This measurement provides the number of transmitted MAC-hs PDUs including acknowledged and unacknowledged PDUs during the period of measurement, detected in MAC-hs layer in the serving HS-DSCH cell.
- b) CC.

- c) On transmission by the NodeB of a PDU of MAC-hs to UE.
- d) A single integer value.
- e) HSDPA.NbrMachsPdu
- f) UtranCellFDD
UtranCellTDDLcr
UtranCellTDDHcr
- g) Valid for packet switched traffic.
- h) UMTS.

4.27 Mean number of HSDPA users in a serving HS-DSCH cell

- a) This measurement provides the mean number of simultaneous HSDPA users in a serving HS-DSCH cell.
- b) SI.
- c) This measurement is obtained by sampling at a pre-defined interval the number of simultaneous users in a serving HS-DSCH cell and then taking the arithmetic mean.
- d) A single integer value.
- e) HSDPA.MeanNbrUser
- f) UtranCellFDD
UtranCellTDDLcr
UtranCellTDDHcr
- g) Valid for packet switched traffic.
- h) UMTS.

4.28 Number of octets of acknowledged MAC-hs PDUs

- a) This measurement provides the number of octets of downlink acknowledged MAC-hs PDUs in the serving HS-DSCH cell.
- b) CC.
- c) On transmission by the NodeB of an acknowledged PDU on the MAC-hs layer. The number of octets of MAC-hs layer in one serving HS-DSCH cell is calculated by sum of size of each MAC-hs PDU header including MAC-hs PDU header.
- d) A single integer value.
- e) HSDPA.NbrAckdMachSocts
- f) UtranCellFDD
UtranCellTDDLcr
UtranCellTDDHcr
- g) Valid for packet switched traffic.
- h) UMTS.

4.29 Number of TTIs with user data packets in buffer

- a) This measurement provides the number of TTIs with user data packets in MAC-hs buffer.

- b) CC.
- c) On receipt by the NodeB of a HSDPA frame with user data packets in MAC-hs buffer.
- d) A single integer value.
- e) HSDPA.NbrTTINonEmptyBuffer
- f) UtranCellFDD
UtranCellTDDLcr
UtranCellTDDHcr
- g) Valid for packet switched traffic.
- h) UMTS.

4.30 HSDPA Release measurements

4.30.1 Overview of HSDPA Release

4.30.1.1 General

The HSDPA release is executed via releasing the HS-DSCH. It can happen with RRC Connection Release procedure and various Radio Bearer Control procedures. The RANAP procedures RAB Assignment Request or Iu Release Command can also be involved.

There is always a RRC procedure used but not necessarily a RANAP procedure.

As there are HSDPA release cases that doesn't involve CN (RANAP) the triggering of required measurements is always based primarily on RRC triggering.

In cases that the CN has initiated the release of a RAB and/or Iu connection that currently has a Radio Bearer including HS-DSCH the RANAP interface is included in the triggering part of the related requirement.

4.30.1.2 Considered RRC procedures

RRC Protocol procedures related HSDPA (HS-DSCH Release)

RRC connection release (TS 25.331: RRC Connection Management procedures chapter 8.1.4):

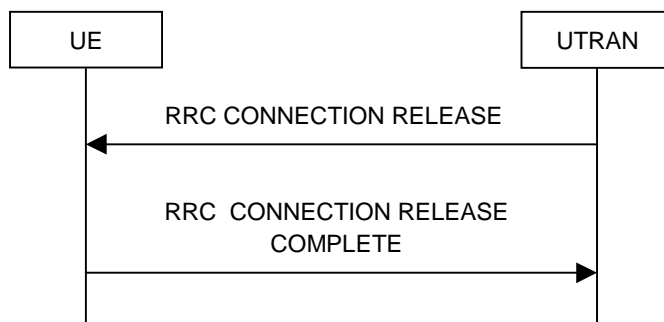

Figure: RRC Connection Release procedure on the DCCH

Radio Bearer control /Reconfiguration procedures (TS25.331 Radio Bearer Control Procedures)

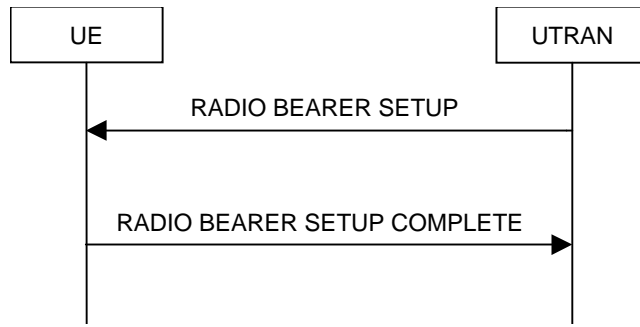

Figure: Radio Bearer Establishment, normal case

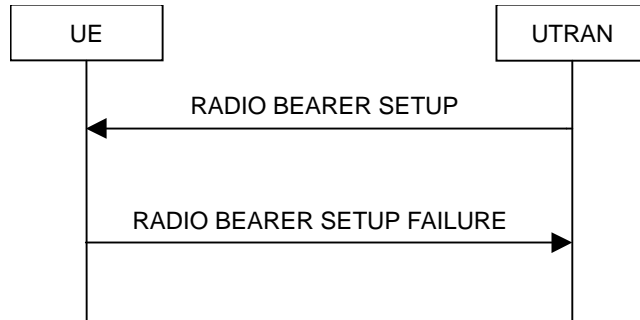

Figure: Radio Bearer Establishment, failure case

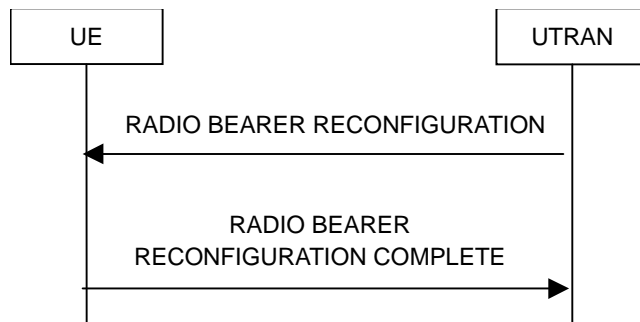

Figure: Radio bearer reconfiguration, normal flow

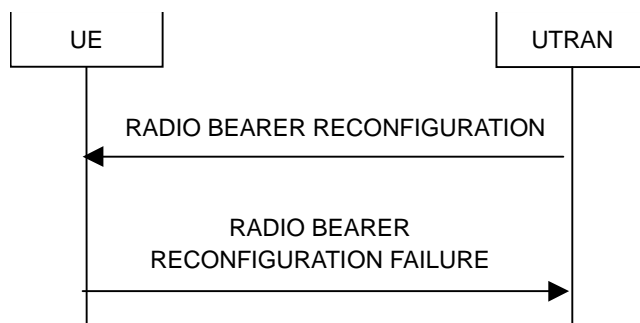

Figure: Radio bearer reconfiguration, failure case

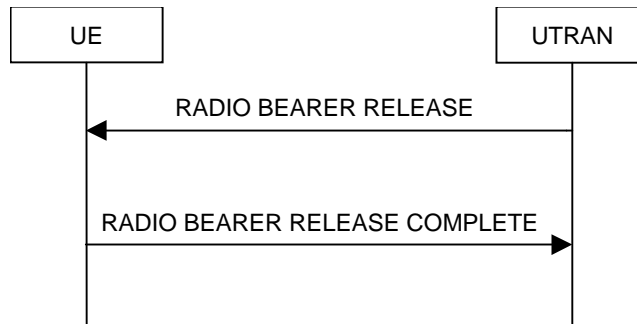

Figure: Radio Bearer Release, normal case

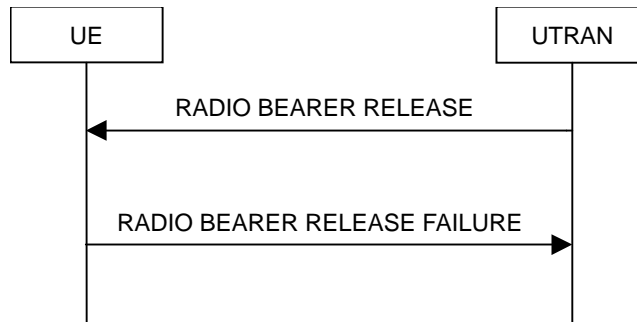

Figure: Radio Bearer Release, failure case

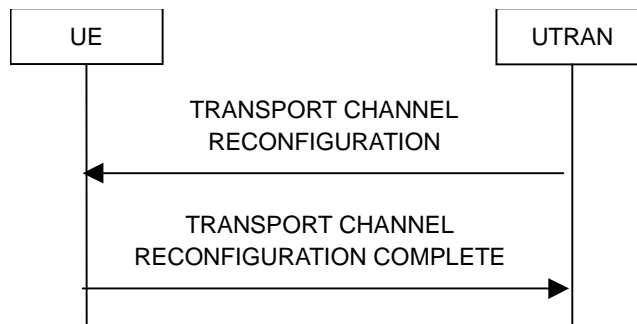

Figure: Transport channel reconfiguration, normal flow

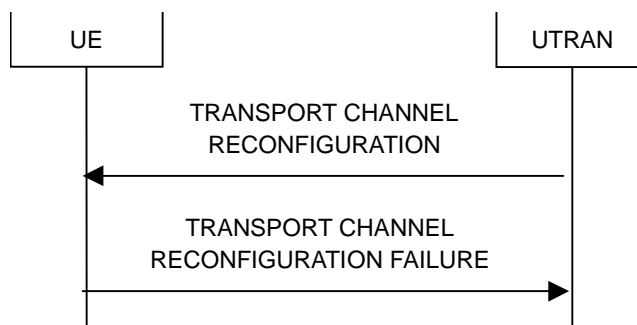

Figure: Transport channel reconfiguration, failure case

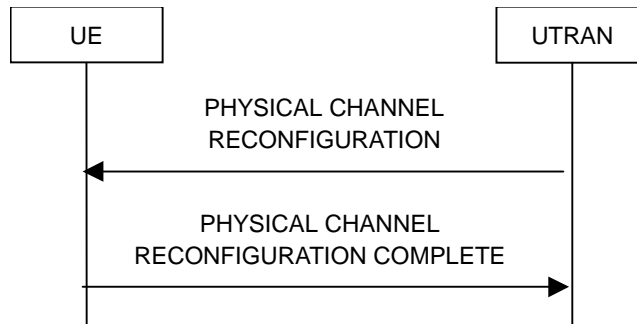

Figure: Physical channel reconfiguration, normal flow

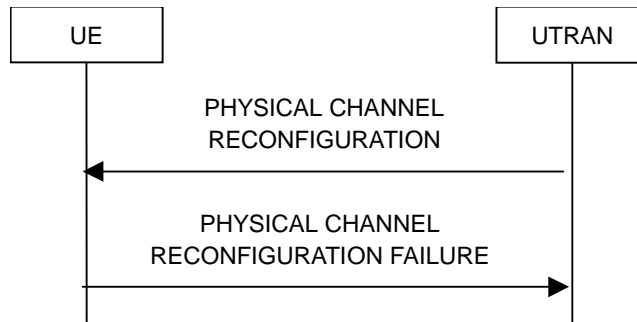
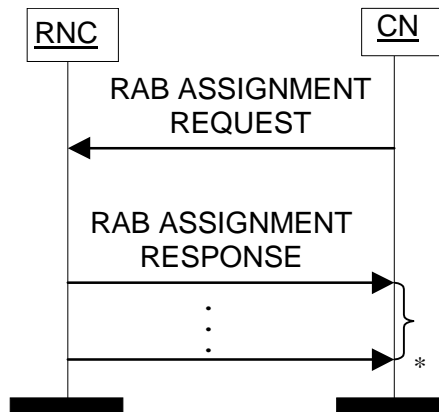

Figure : Physical channel reconfiguration, failure case

4.30.1.3 Considered RANAP protocol procedures

RAB Assignment (TS 25.413 Chapter 8.2)



* it can be several responses

Figure: RAB Assignment procedure. Successful operation.

Iu Release (TS 25.413 Chapter 8.5)

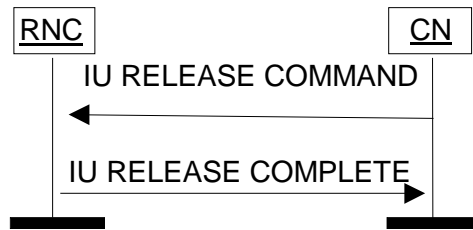

Figure: Iu Release procedure. Successful operation.

4.30.2 Normal HSDPA Release

4.30.2.1 RNC Initiated Release due to user inactivity

- a) This measurement provides the number of times when the UE is removed from HS-DSCH transport channel due to user inactivity
- b) CC.
- c) On transmission of the RRC: RADIO BEARER RECONFIGURATION or RRC: RADIO BEARER RELEASE or RRC CONNECTION RELEASE message by the RNC when there is no more data left in the buffer to send (equals to the RANAP cause 16 user inactivity).
- d) A single integer value.
- e) The measurement name has the form HSDPA.SuccHSDSCHreleaseUserInact
- f) UtranCellFDD
UtranCellTDDLcr
UtranCellTDDHcr.
- g) Valid for packet switched traffic.
- h) UMTS.

4.30.2.2 Switch to DCH/FACH

The measurement definition is in section 4.24

4.30.2.3 HS-DSCH serving cell change

The measurement definition is in section 4.25

4.30.2.4 CN Initiated release

- a) This measurement provides the number of times when the UE is removed from HS-DSCH transport channel due to a release initiated by the Core Network.
- b) CC.
- c) On reception of RANAP RAB ASSIGNMENT REQUEST or RANAP IU RELEASE COMMAND that results an HS-DSCH release. The release of HS-DSCH is executed by the transmission of the RRC RADIO BEARER RECONFIGURATION or RRC RADIO BEARER RELEASE or RRC CONNECTION RELEASE message.
- d) A single integer value.
- e) The measurement name has the form HSDPA.SuccCnInitHSDSCHrelease
- f) UtranCellFDD
UtranCellTDDLcr
UtranCellTDDHcr.

- g) Valid for packet switched traffic.
- h) UMTS.

4.30.3 Abnormal RB releases for HS-DSCH

- a) This measurement provides the number of times when the UE is removed from HS-DSCH transport channel, and trigger reason is a failure. The reason can be e.g. RL failure.
- b) CC.
- c) On receipt by the RRC: RADIO BEARER RECONFIGURATION COMPLETE, or RRC: RADIO BEARER RELEASE COMPLETE message sent by the UE. Or when the UE does not respond to RRC: RADIO BEARER RECONFIGURATION or RRC: RADIO BEARER RELEASE message. All other release scenarios are considered as abnormal releases, which are not counted in normal releases, i.e. the release is not because of user inactivity or switch to DCH or HS-DSCH serving cell changes or CN initiated release.
- d) A single integer value.
- e) The measurement name has the form HS.failHSDSCHrelease
- f) UtranCellFDD
UtranCellTDDLcr
UtranCellTDDHcr.
- g) Valid for packet switched traffic.
- h) UMTS.

4.31 RRC Connection mobility

4.31.1 Cell update

4.31.1.1 Attempted cell update

- a) This measurement provides the number of cell update attempts per update cause sent from the UE to UTRAN.
- b) CC
- c) Receipt of a CELL UPDATE message sent from UE to the RNC. Each cell update message sent is added to the relevant per cause measurement. The possible causes are included in TS 25.331 [4]. The sum of all supported per cause measurements shall equal the total number of cell update attempts. In case only a subset of per cause measurements is supported, a sum subcounter will be provided first.
- d) Each measurement is an integer value. The number of measurements is equal to the number of causes plus a possible sum value identified by the *.sum* suffix.
- e) The measurement name has the form RRC.AttCellUpdate.*Cause* where *Cause* identifies the Cell Update Cause.
- f) UtranCellFDD
UtranCellTDDLcr
UtranCellTDDHcr
- g) Valid for circuit switched and packet switched traffic
- h) UMTS

4.32 Measurements related to received uplink transport block

4.32.1 Measurements related to received uplink transport block for CS domain

4.32.1.1 Number of received uplink transport blocks of DCH for CS domain

- a) This measurement provides the number of received uplink transport blocks of DCH during the period of measurement for the CS domain. In case of soft handover, this measurement is valid after combination, based on best UTRAN cell for FDD mode only.
- b) CC.
- c) On receipt by the RNC of an uplink transport block of DCH from UE for CS domain. For conversational service, the relevant measurement for each specified data rate is required. The detailed data rates are listed below (see TS 25.993 [12]).

uplink <U>:

- 1: AMR rate (12.2 10.2 7.95 7.4 6.7 5.9 5.15 4.75) kbps
- 2: 12.2 kbps
- 3: 28.8 kbps
- 4: 32 kbps
- 5: 64 kbps

As indicated above <U> maps to the conversational service specified uplink data rates.

- d) A single integer value.
- e) FP.NbrBlocksReceivedCS.Conv.<U>
FP.NbrBlocksReceivedCS.Strm
FP.NbrBlocksReceivedCS.Intact
FP.NbrBlocksReceivedCS.Bgrd
- f) UtranCellFDD
UtranCellTDDLcr
UtranCellTDDHcr
- g) Valid for circuit switched traffic.
- h) UMTS.

4.32.1.2 Number of received uplink faulty transport blocks of DCH for CS domain

- a) This measurement provides the number of received uplink faulty transport blocks of DCH during the period of measurement for CS domain. In case of soft handover, this measurement is valid after combination, based on best UTRAN cell for FDD mode only.
- b) CC.
- c) On receipt by the RNC of an uplink faulty transport block using CRC indicator (see TS 25.427[17]) of DCH from UE for CS domain. For conversational service, the relevant measurement for each specified data rate is required. The detailed data rates are listed below (see TS 25.993 [12]).

uplink <U>:

- 1: AMR rate (12.2 10.2 7.95 7.4 6.7 5.9 5.15 4.75) kbps
- 2: 12.2 kbps
- 3: 28.8 kbps
- 4: 32 kbps
- 5: 64 kbps

As indicated above <U> maps to the conversational service specified uplink data rates.

- d) A single integer value.
- e) FP.NbrErrBlocksReceivedCS.Conv.<U>
FP.NbrErrBlocksReceivedCS.Strm

FP.NbrErrBlocksReceivedCS.Intact
 FP.NbrErrBlocksReceivedCS.Bgrd

- f) UtranCellFDD
 UtranCellTDDLcr
 UtranCellTDDHcr
- g) Valid for circuit switched traffic.
- h) UMTS.

4.32.2 Measurements related to received uplink transport block for PS domain

4.32.2.1 Number of received uplink transport blocks of DCH for PS domain

- a) This measurement provides the number of received uplink transport blocks of DCH during the period of measurement for PS domain. In case of soft handover, this measurement is valid after combination, based on best UTRAN cell for FDD mode only.
- b) CC.
- c) On receipt by the RNC of an uplink transport block of DCH from UE for PS domain. For conversational service, the relevant measurement for each specified data rate is required. The detailed data rates are listed below (see TS 25.993 [12]).
 uplink <U>:

- 1: AMR rate (12.2 10.2 7.95 7.4 6.7 5.9 5.15 4.75) kbps
- 2: 12.2 kbps
- 3: 28.8 kbps
- 4: 32 kbps
- 5: 64 kbps

As indicated above <U> maps to the conversational service specified uplink data rates.

- d) A single integer value.
- e) FP.NbrBlocksReceivedPS.Conv.<U>
 FP.NbrBlocksReceivedPS.Strm
 FP.NbrBlocksReceivedPS.Intact
 FP.NbrBlocksReceivedPS.Bgrd
- f) UtranCellFDD
 UtranCellTDDLcr
 UtranCellTDDHcr

- g) Valid for packet switched traffic.
- h) UMTS.

4.32.2.2 Number of received uplink faulty transport blocks of DCH for PS domain

- a) This measurement provides the number of received uplink faulty transport blocks of DCH during the period of measurement for PS domain. In case of soft handover, this measurement is valid after combination, based on best UTRAN cell for FDD mode only.
- b) CC.
- c) On receipt by the RNC of an uplink faulty transport block using CRC indicator (see TS 25.427[17]) of DCH from UE for PS domain. For conversational service, the relevant measurement for each specified data rate is required. The detailed data rates are listed below (see TS 25.993 [12]).
 uplink <U>:

- 1: AMR rate (12.2 10.2 7.95 7.4 6.7 5.9 5.15 4.75) kbps
- 2: 12.2 kbps
- 3: 28.8 kbps

4: 32 kbps

5: 64 kbps

As indicated above <U> maps to the conversational service specified uplink data rates.

- d) A single integer value.
- e) FP.NbrErrBlocksReceivedPS.Conv.<U>
FP.NbrErrBlocksReceivedPS.Strm
FP.NbrErrBlocksReceivedPS.Intact
FP.NbrErrBlocksReceivedPS.Bgrd
- f) UtranCellFDD
UtranCellTDDLcr
UtranCellTDDHcr
- g) Valid for packet switched traffic.
- h) UMTS.

Annex A (informative): Change history

Change history								
Date	TSG #	TSG Doc.	CR	Rev	Subject/Comment	Cat	Old	New
Mar 2006	SA_31	SP-060108	--	--	Split of 32.403-710 into four new TSs 32.404, 32.405, 32.406, 32.408. Submitted to TSG SA #31 for Approval.	--	1.0.0	7.0.0
Jun 2006	SA_32	SP-060260	0001	--	Add TDD Counters to Measure Mean Code Resources Used	B	7.0.0	7.1.0
Jun 2006	SA_32	SP-060260	0002	--	Add ATM layer performance measurements	B	7.0.0	7.1.0
Jun 2006	SA_32	SP-060260	0003	--	Add Power Counters for radio channel monitoring	B	7.0.0	7.1.0
Jun 2006	SA_32	SP-060260	0004	--	Add measurements about Radio Access Bearer (RAB) related to lu release request	B	7.0.0	7.1.0
Jun 2006	SA_32	SP-060260	0005	--	Add paging counters for UTRAN	B	7.0.0	7.1.0
Jun 2006	SA_32	SP-060260	0006	--	Correction for wrong reference to TS 25.331	F	7.0.0	7.1.0
Jun 2006	SA_32	SP-060260	0007	--	Correction for TDD Counters to Measure Max Code Resources Used	F	7.0.0	7.1.0
Jun 2006	SA_32	SP-060260	0008	--	Add measurements about SHO radio link performance	B	7.0.0	7.1.0
Sep 2006	SA_33	SP-060663	0009	1	Add RRC Connection Usage Measurements to fully gauge the usage of the UTRAN	B	7.1.0	7.2.0
Sep 2006	SA_33	SP-060663	0010	1	Correction to TDD measurements for Received Total Wideband Power and Transmitted Carrier Power	F	7.1.0	7.2.0
Sep 2006	SA_33	SP-060550	0011	--	Add measurements about RAB with different data rates of conversational service - Align with RAN2's 25.993	B	7.1.0	7.2.0
Sep 2006	SA_33	SP-060550	0012	--	Add measurements about the non-HS carrier power - Align with RAN3's 25.433	B	7.1.0	7.2.0
Sep 2006	SA_33	SP-060550	0013	--	Add Uplink ISCP measurements in PM for TDD	B	7.1.0	7.2.0
Sep 2006	SA_33	SP-060550	0014	--	Add measurements about the non-HS carrier power for TDD	B	7.1.0	7.2.0
Sep 2006	SA_33	SP-060550	0015	--	Constrain the applicability of performance measurements related to lur interface	C	7.1.0	7.2.0
Sep 2006	SA_33	SP-060550	0016	--	Add measurements about call duration in utran cell for CS domain	B	7.1.0	7.2.0
Sep 2006	SA_33	SP-060550	0017	--	Add measurements related to channel switches for HSDPA	B	7.1.0	7.2.0
Sep 2006	SA_33	SP-060550	0018	--	Add measurements about the HSDPA mobility management	B	7.1.0	7.2.0
Sep 2006	SA_33	SP-060550	0019	--	Add HSDPA setup related measurements	B	7.1.0	7.2.0
Dec 2006	SA_34	SP-060726	0020	--	Correction of the HHO measurements	C	7.2.0	7.3.0
Dec 2006	SA_34	SP-060726	0021	--	Add Measurements related to MAC-hs	B	7.2.0	7.3.0
Dec 2006	SA_34	SP-060726	0022	--	Correct the measurements related to RAB release request by CN - Align with 25.413	F	7.2.0	7.3.0
Mar 2007	SA_35	SP-070048	0023	-	Distinguish Hard Handover counters for FDD and TDD mode	F	7.3.0	7.4.0
Mar 2007	SA_35	SP-070048	0024	-	Add measurements related to number of HSDPA users	B	7.3.0	7.4.0
Mar 2007	SA_35	SP-070048	0025	-	Add measurements related to MAC-hs data rate	B	7.3.0	7.4.0
Jun 2007	SA_36	SP-070278	0026	--	Add missing measurements related to cell update	F	7.4.0	7.5.0
Jun 2007	SA_36	SP-070278	0027	--	Add missing No Reply cause to HSDPA setup measurements	F	7.4.0	7.5.0
Jun 2007	SA_36	SP-070280	0028	--	Add HSDPA release measurements	B	7.4.0	7.5.0
Jun 2007	SA_36	SP-070278	0029	--	Change the measured object class UtranCell to the new model in 32.642	F	7.4.0	7.5.0
Jun 2007	SA_36	SP-070279	0030	--	Add block error rate related measurements	B	7.4.0	7.5.0

History

Document history		
V7.5.0	June 2007	Publication