

ETSI TS 132 421 V14.0.0 (2017-04)



TECHNICAL SPECIFICATION

**Digital cellular telecommunications system (Phase 2+) (GSM);
Universal Mobile Telecommunications System (UMTS);
LTE;
Telecommunication management;
Subscriber and equipment trace;
Trace concepts and requirements
(3GPP TS 32.421 version 14.0.0 Release 14)**



Reference

RTS/TSGS-0532421ve00

Keywords

GSM,LTE,UMTS

ETSI

650 Route des Lucioles
F-06921 Sophia Antipolis Cedex - FRANCE

Tel.: +33 4 92 94 42 00 Fax: +33 4 93 65 47 16

Siret N° 348 623 562 00017 - NAF 742 C
Association à but non lucratif enregistrée à la
Sous-Préfecture de Grasse (06) N° 7803/88

Important notice

The present document can be downloaded from:

<http://www.etsi.org/standards-search>

The present document may be made available in electronic versions and/or in print. The content of any electronic and/or print versions of the present document shall not be modified without the prior written authorization of ETSI. In case of any existing or perceived difference in contents between such versions and/or in print, the only prevailing document is the print of the Portable Document Format (PDF) version kept on a specific network drive within ETSI Secretariat.

Users of the present document should be aware that the document may be subject to revision or change of status.

Information on the current status of this and other ETSI documents is available at

<https://portal.etsi.org/TB/ETSI/DeliverableStatus.aspx>

If you find errors in the present document, please send your comment to one of the following services:

<https://portal.etsi.org/People/CommiteeSupportStaff.aspx>

Copyright Notification

No part may be reproduced or utilized in any form or by any means, electronic or mechanical, including photocopying and microfilm except as authorized by written permission of ETSI.

The content of the PDF version shall not be modified without the written authorization of ETSI.

The copyright and the foregoing restriction extend to reproduction in all media.

© European Telecommunications Standards Institute 2017.

All rights reserved.

DECT™, **PLUGTESTS™**, **UMTS™** and the ETSI logo are Trade Marks of ETSI registered for the benefit of its Members.

3GPP™ and **LTE™** are Trade Marks of ETSI registered for the benefit of its Members and of the 3GPP Organizational Partners.

oneM2M logo is protected for the benefit of its Members

GSM® and the GSM logo are Trade Marks registered and owned by the GSM Association.

Intellectual Property Rights

IPRs essential or potentially essential to the present document may have been declared to ETSI. The information pertaining to these essential IPRs, if any, is publicly available for **ETSI members and non-members**, and can be found in ETSI SR 000 314: "*Intellectual Property Rights (IPRs); Essential, or potentially Essential, IPRs notified to ETSI in respect of ETSI standards*", which is available from the ETSI Secretariat. Latest updates are available on the ETSI Web server (<https://ipr.etsi.org>).

Pursuant to the ETSI IPR Policy, no investigation, including IPR searches, has been carried out by ETSI. No guarantee can be given as to the existence of other IPRs not referenced in ETSI SR 000 314 (or the updates on the ETSI Web server) which are, or may be, or may become, essential to the present document.

Foreword

This Technical Specification (TS) has been produced by ETSI 3rd Generation Partnership Project (3GPP).

The present document may refer to technical specifications or reports using their 3GPP identities, UMTS identities or GSM identities. These should be interpreted as being references to the corresponding ETSI deliverables.

The cross reference between GSM, UMTS, 3GPP and ETSI identities can be found under <http://webapp.etsi.org/key/queryform.asp>.

Modal verbs terminology

In the present document "**shall**", "**shall not**", "**should**", "**should not**", "**may**", "**need not**", "**will**", "**will not**", "**can**" and "**cannot**" are to be interpreted as described in clause 3.2 of the [ETSI Drafting Rules](#) (Verbal forms for the expression of provisions).

"**must**" and "**must not**" are **NOT** allowed in ETSI deliverables except when used in direct citation.

Contents

Intellectual Property Rights	2
Foreword.....	2
Modal verbs terminology.....	2
Foreword.....	5
Introduction	6
1 Scope	7
2 References	8
3 Definitions, symbols and abbreviations	9
3.1 Definitions	9
3.2 Abbreviations	11
4 Trace concepts and high-level architecture	12
4.1 Trace concepts	12
4.2 Trace high level Architecture	14
4.3 Service Level Tracing for IMS high level Architecture	17
5 Trace requirements	19
5.1 General trace requirements	19
5.2 Requirements for Trace data	20
5.3 Requirements for Trace activation	21
5.3.1 Requirements for Trace Session activation.....	21
5.3.2 Requirements for starting a Trace Recording Session	23
5.4 Requirements for Trace deactivation.....	25
5.4.1 Requirements for Trace Session deactivation	25
5.4.2 Requirements for stopping a Trace Recording Session	25
5.5 Requirements for Trace Data reporting	27
5.6 Requirements for Privacy and Security	29
5.7 Requirements for Charging	29
5.8 Use cases for Trace.....	30
6 Requirements for managing MDT	31
6.1 Business Level Requirements.....	31
6.2 Specification level requirements	32
6.2.1 Logged MDT and Immediate MDT requirements.....	32
6.2.2 Logged MBSFN MDT requirements	33
7 Requirements for managing RLF reports.....	35
7.1 Business level requirements	35
7.2 Specification level requirements	35
Annex A (informative): Trace use cases	36
A.1 Use case #1: multi-vendor UE validation.....	36
A.1.1 Description	36
A.1.2 Example of required data for this use case	36
A.2 Use case #2: subscriber complaint	36
A.2.1 Description	36
A.2.2 Example of required data for this use case	37
A.3 Use case #3: malfunctioning UE	38
A.3.1 Description	38
A.3.2 Example of required data for this use case	38
A.4 Use case #4: checking radio coverage.....	38
A.4.1 Description	38
A.4.2 Example of required data to cover use case #4.....	38

A.5	Use case #5: testing a new feature.....	39
A.5.1	Description	39
A.5.2	Example of required data to cover use case #5.....	39
A.6	Use case #6: fine-tuning and optimisation of algorithms/procedures	40
A.6.1	Description	40
A.6.2	Example of required data to cover use case #6.....	41
A.7	Use case #7: Automated testing of Service Provider services.....	41
A.7.1	Description	41
A.8	Use case #8: Regression testing following a network fix.....	41
A.8.1	Description	41
A.9	Use case #9: Service fault localization within a Service Provider network	41
A.9.1	Description	41
A.10	Use case #10: Service fault localization when a service is hosted by a third party Service Provider ...	41
A.10.1	Description	41
A.11	Use case #11 Analysing drop calls in E-UTRAN	42
A.11.1	Description	42
A.11.2	Example of required data to cover use case #11.....	42
A.12	Use case #12 Periodical sampling of network performance	42
A.12.1	Description	42
A.12.2	Example of required data to cover use case #12.....	42
A.13	Use case #13 Differentiation of area based MDT data by terminal type.....	43
A.13.1	Description	43
A.13.2	Example of required data to cover use case #13.....	43
A.14	Use case #14 Subscriber complaint about MBMS service in the eUTRAN network	43
A.14.1	Description	43
A.14.2	Example of required data to cover use case #14.....	43
A.15	Use case #15 Check MBMS service quality and performance of the eUTRAN Network.....	44
A.15.1	Description	44
A.15.2	Example of required data to cover use case #15.....	44
Annex B (informative):	Change history	45
	History	47

Foreword

This Technical Specification has been produced by the 3rd Generation Partnership Project (3GPP).

The contents of the present document are subject to continuing work within the TSG and may change following formal TSG approval. Should the TSG modify the contents of the present document, it will be re-released by the TSG with an identifying change of release date and an increase in version number as follows:

Version x.y.z

where:

- x the first digit:
 - 1 presented to TSG for information;
 - 2 presented to TSG for approval;
 - 3 or greater indicates TSG approved document under change control.
- y the second digit is incremented for all changes of substance, i.e. technical enhancements, corrections, updates, etc.
- z the third digit is incremented when editorial only changes have been incorporated in the document.

Introduction

The present document is part of a TS-family covering the 3rd Generation Partnership Project; Technical Specification Group Services and System Aspects; Telecommunication management, as identified below:

TS 32.421: "Subscriber and equipment trace: Trace concepts and requirements";

TS 32.422: "Subscriber and equipment trace: Trace control and configuration management";

TS 32.423: "Subscriber and equipment trace: Trace data definition and management";

Subscriber and equipment trace provide very detailed information at call level on one or more specific mobile(s). This data is an additional source of information to Performance Measurements and allows going further in monitoring and optimisation operations.

Contrary to Performance measurements, which are a permanent source of information, trace is activated on user demand for a limited period of time for specific analysis purposes.

Trace plays a major role in activities such as determination of the root cause of a malfunctioning mobile, advanced troubleshooting, optimisation of resource usage and quality, RF coverage control and capacity improvement, dropped call analysis, Core Network and UTRAN end-to-end UMTS procedure validation.

The capability to log data on any interface at call level for a specific user (e.g. IMSI) or mobile type (e.g. IMEI or IMEISV), or service initiated by a user allows getting information which cannot be deduced from Performance measurements such as perception of end-user QoS during his call (e.g. requested QoS vs. provided QoS), correlation between protocol messages and RF measurements, or interoperability with specific mobile vendors.

Moreover, performance measurements provide values aggregated on an observation period; Subscriber and UE Trace give instantaneous values for a specific event (e.g. call, location update, etc.).

If performance measurements are mandatory for daily operations, future network planning and primary trouble shooting; Subscriber and UE Trace is the easy way to go deeper into investigation and UMTS network optimisation.

In order to produce this data, Subscriber and UE Trace are carried out in the NEs, which comprise the network. The data can then be transferred to an external system (e.g. an Operations System (OS) in TMN terminology, for further evaluation).

1 Scope

The present document describes the requirements for the management of Trace and the reporting of Trace data (including FDD mode and TDD mode) across UMTS networks or EPS networks as it refers to subscriber tracing (tracing of IMSI or Public User Identity) and equipment tracing (tracing of IMEI or IMEISV). Trace also includes the ability to trace all active calls in a cell or multiple cells (Cell Traffic Trace). The present document also includes the description of Service Level Tracing (tracing of a specific service). It defines the administration of Trace Session activation/deactivation by the Element Manager (EM), the network or User Equipment (UE) itself via signalling, the generation of Trace results in the Network Elements (NEs) and UE and the transfer of these results to one or more Operations Systems, i.e. EM(s) and/or Network Manager(s) (NM(s)).

GSM Trace is outside of the scope of this specification (see [7]).

The present document also describes the requirements for the management of Minimization of Drive Tests (MDT) across UMTS networks or EPS networks and Radio Link Failure (RLF) reporting across EPS networks.

The present document is built upon the basic Subscriber and UE Trace concept described in clause 4. The high-level requirements for Trace data, Trace Session activation/deactivation and Trace reporting are defined in clause 5. Clause 5 also contains an overview of use cases for Trace (the use cases are described in Annex A). Clause 6 defines the requirements for managing MDT. Clause 7 defines the requirements for managing RLF reports. Trace control and configuration management are described in 3GPP TS 32.422 [2], and Trace data definition and management are described in 3GPP TS 32.423 [3].

The present document does not cover any Trace capability limitations within a NE (e.g. maximum number of simultaneous traced mobiles for a given NE) or any functionality related to these limitations (e.g. NE aborting a Trace Session due to resource limitations).

The objectives of the Trace specifications are:

- a) to provide the descriptions for a standard set of Trace and MDT data;
- b) to produce a common description of the management technique for Trace, MDT and RLF administration and result reporting;
- c) to define a method for the reporting of Trace, MDT and RLF results across the management interfaces.

The following is beyond the scope of the present document, and therefore the present document does not describe:

- tracing non-Subscriber or non-UE related events within an NE;
- tracing of all possible parties in a multi-party call (although multiple calls related to the IMSI specified in the Trace control and configuration parameters are traceable).

The definition of Trace and MDT data is intended to result in comparability of Trace and MDT data produced in a multi-vendor wireless UMTS and/or EPS network(s), for those Trace control and configuration parameters that can be standardised across all vendors' implementations.

Vendor specific extensions to the Trace control and configuration parameters and Trace and MDT data are discussed in 3GPP TS 32.422 [2] and 3GPP TS 32.423 [3].

All functions (trace, MDT etc.) specified in this specification support Network Sharing, with the following conditions:

- It is accepted that the recorded information from the shared nodes is available to the Master Operator. Recorded information that is collected in a non shared node or cell will only be available to the operator managing the non shared node or cell.
- It is accepted that the recorded information from the shared network shall be delivered to the Participating Operator whose PLMN recording is requested, taking user consent into account. Operators must also agree on sharing the information, but how that agreement is done is outside the scope of this specification. The mapping of TCE IP addresses and TCE addresses must be coordinated among the operators that shares the network. How that coordination is done is outside the scope of this specification.
- It is accepted that the inter-PLMN recorded information for Logged MDT from the non-shared nodes of Participating Operators may be available to the Master Operator.

- For signalling based activation, the operators that share a network must coordinate the TCE IP addresses and the TCE address mapping must be coordinated. How that coordination is done is outside the scope of this specification.
- The 3GPP Management reference model, 3GPP TS 32.101 [1] is followed.

2 References

The following documents contain provisions, which, through reference in this text, constitute provisions of the present document.

- References are either specific (identified by date of publication, edition number, version number, etc.) or non-specific.
- For a specific reference, subsequent revisions do not apply.
- For a non-specific reference, the latest version applies. In the case of a reference to a 3GPP document (including a GSM document), a non-specific reference implicitly refers to the latest version of that document *in the same Release as the present document*.

- [1] 3GPP TS 32.101: "Telecommunication management; Principles and high level requirements".
- [2] 3GPP TS 32.422: "Telecommunication management; Subscriber and equipment trace: Trace control and configuration management".
- [3] 3GPP TS 32.423: "Telecommunication management; Subscriber and equipment trace: Trace data definition and management".
- [4] 3GPP TS 23.002: "Network architecture".
- [6] 3GPP TS 29.207: "Policy control over Go interface".
- [7] 3GPP TS 52.008: "Telecommunication management; GSM subscriber and equipment trace".
- [8] 3GPP TR 21.905: "Vocabulary for 3GPP Specifications".
- [9] OMA Service Provider Environment Requirements, OMA-RD-OSPE-V1_0-20050614-C, The Open Mobile Alliance™ ([URL:http://www.openmobilealliance.org/](http://www.openmobilealliance.org/))
- [10] 3GPP TS 33.401: "System Architecture Evolution (SAE); Security architecture".
- [11] 3GPP TS 37.320 : "Universal Terrestrial Radio Access (UTRA) and Evolved Universal Terrestrial Radio Access (E-UTRA); Radio measurement collection for Minimization of Drive Tests (MDT); Overall description, Stage 2".
- [12] 3GPP TS 32.450: "Key Performance Indicators (KPI) for Evolved Universal Terrestrial Radio Access Network (E-UTRAN): Definitions".
- [13] 3GPP TS 32.130: "Network sharing; Concepts and requirements".
- [14] 3GPP TS 36.300: "Evolved Universal Terrestrial Radio Access (E-UTRA) and Evolved Universal Terrestrial Radio Access Network (E-UTRAN); Overall description; Stage 2".

NOTE: Overall management principles are defined in 3GPP TS 32.101 [1].

3 Definitions, symbols and abbreviations

3.1 Definitions

For the purposes of the present document, the terms and definitions given in 21.905 [8] , 32.130 and the following apply:

Cell Traffic Trace: The ability to trace one or more active calls in one or more cells.

Collection Period: TBD

Editor's note: This definition requires RAN2 input.

End user visible events: Refer to OMA Service Provider Requirements [9].

Immediate MDT: See 3GPP TS 37.320 [11].

Logged MDT: See 3GPP TS 37.320 [11].

management activation/deactivation: Trace Session is activated/deactivated in different NEs directly from the EM using the management interfaces of those NEs.

MDT Measurements: See 3GPP TS 37.320 [11].

MBSFN Area: See 3GPP TS 36.300 [14].

MBSFN Area Reserved Cell: See 3GPP TS 36.300 [14].

Signalling Based Activation/Deactivation: Trace Session is activated/deactivated in different NEs using the signalling interfaces between those elements so that the NEs may forward the activation/deactivation originating from the EM

System Context: two different realisations of the telecommunication management architecture. System Context A has the Itf-N between a Network Manager and an Element Manger. System Context B has the Itf-N between a Network Manager and a Network Element that has an embedded Element Manager. See figure 1 in TS 32.101 [1].

Reporting Period: TBD

Editor's note: This definition requires RAN2 input.

Trace: general term used for Subscriber, Equipment and Service Trace.

Trace record: in the NE a Trace record is a set of Traceable data collected as determined by the Trace control and configuration parameters.

Trace Recording Session: time interval within a Trace Session while trace records are generated for the Subscriber, UE or Service being traced. The triggering events starting and stopping a Trace Recording Session are defined in 3GPP TS 32.422 [2] (see figure 1).

Trace Recording Session Reference: identifies a Trace Recording Session within a Trace Session (see figure 1)

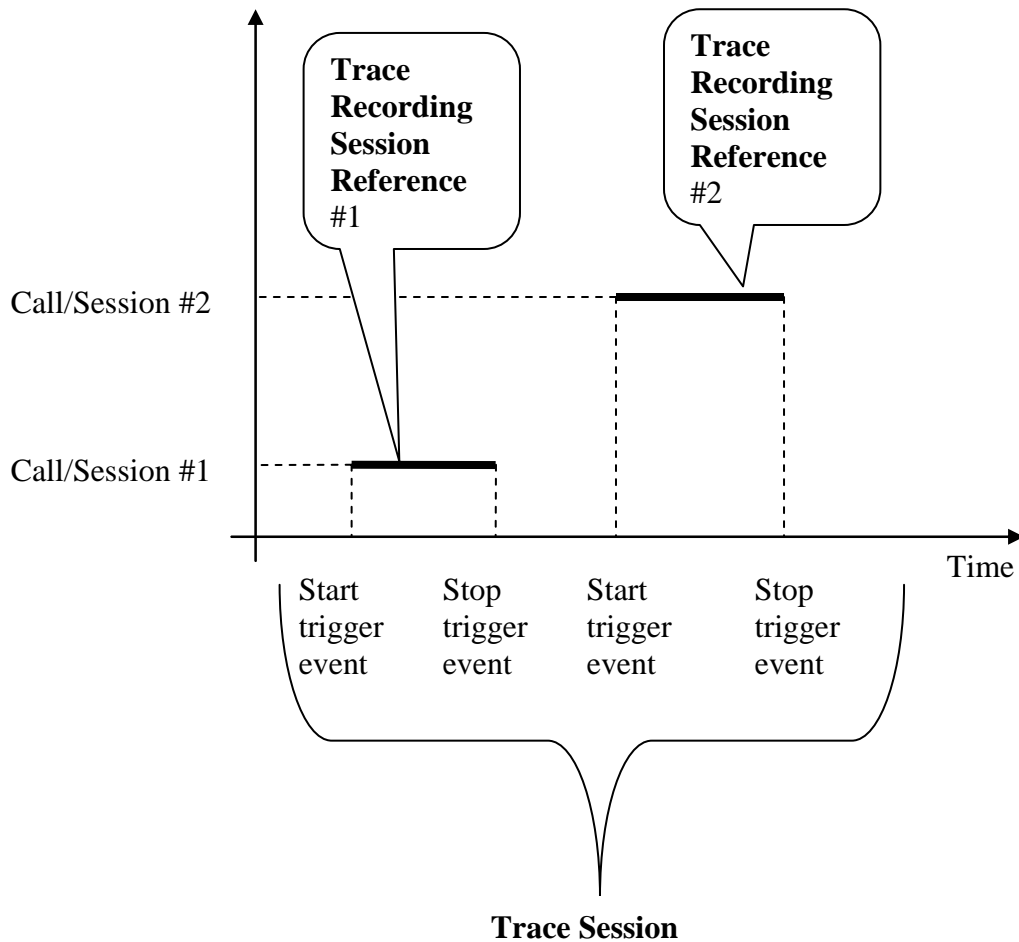

Figure 1: Trace Recording Session

Note that overlapping calls/sessions are possible for e.g. Cell Traffic Trace.

Trace Reference: identifies a Trace Session and is globally unique (see figure 2)

Trace Session: time interval started with a Trace Session Activation and lasts until the Deactivation of that specific Trace Session (see figure 2)

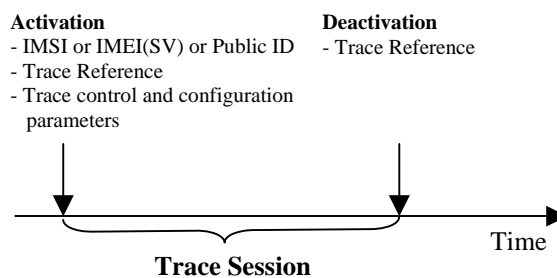

Figure 2: Trace Session

Trace Parameter Configuration: a technique whereby a request for tracing a certain Subscriber, UE or Service is sent by the EM to the NE for execution.

Trace Parameter Propagation: a technique by which the NE processes the trace configuration (received from the EM or another NE) and sends it to the relevant Network Element(s) via signalling interface(s).

Service Level Tracing: Refer to OMA Service Provider Requirements [9].

3.2 Abbreviations

For the purposes of the present document, the abbreviations given in 21.905 [8], 32.101 [1], 32.130 [13] and the following apply:

MBSFN	MBMS over a Single Frequency Network
MBMS	Multimedia Broadcast Multicast Services
MDT	Minimization of Drive Tests
RLF	Radio Link Failure TCE Trace Collection Entity

4 Trace concepts and high-level architecture

4.1 Trace concepts

The diversity of Trace requirements makes it difficult to identify and anticipate all the operator's specific needs. Thus, the objective of this TS is not to list an exhaustive set of information to meet all the requirements. Rather, Trace data is defined without any limitation on the 2 following dimensions:

- Trace scope: NEs and signalling interfaces to Trace.
- Trace depth: level of details of Trace data.

In order not to have any limitation of Trace data, there are six levels of details defined: Maximum, Minimum, Medium, MaximumWithoutVendorSpecificExtension, MinimumWithoutVendorSpecificExtension and MediumWithoutVendorSpecificExtension. The first three levels allow for vendor specific information to be traced and sent in the trace report file.

The Maximum (or MaximumWithoutVendorSpecificExtension) Levels allow all Trace data to be recorded. The other Levels provide a decoded subset of the data in the Maximum Level and allow an operator the flexibility in selecting the appropriate Trace data to record.

The Trace Depth, specified at the Trace Session activation, is used to choose the level of detail of information to retrieve on the Itf-N.

The Maximum (or MaximumWithoutVendorSpecificExtension) Levels of detail allow for retrieval of signalling interface messages within the Trace Scope in encoded format (see figure 4.1.1).

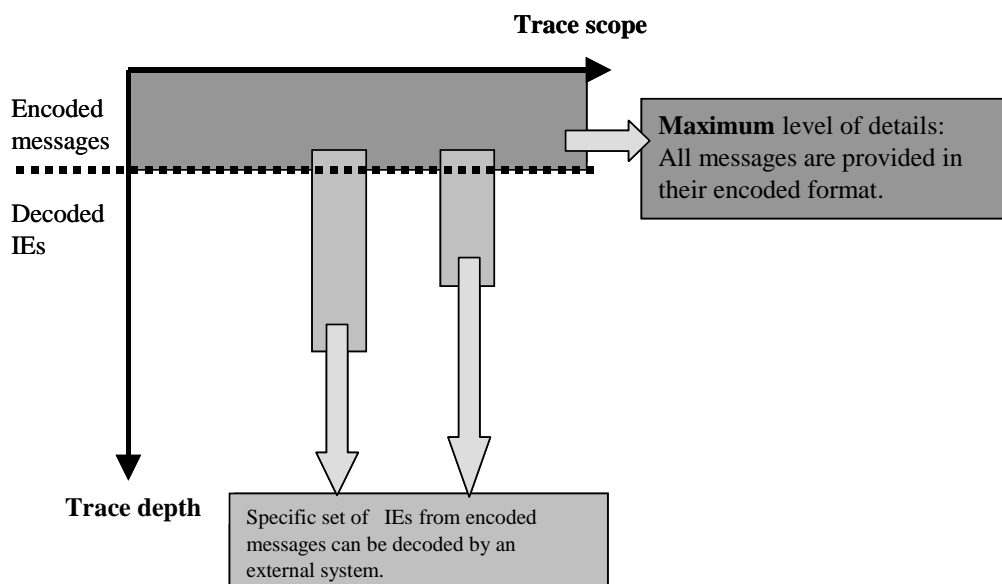

Figure 4.1.1: Maximum (or MaximumWithoutVendorSpecificExtension) Levels of details of Trace

The Minimum (or MinimumWithoutVendorSpecificExtension) Levels of detail allow for retrieval of a decoded subset of the IEs contained in the signalling interface messages (see figure 4.1.2).

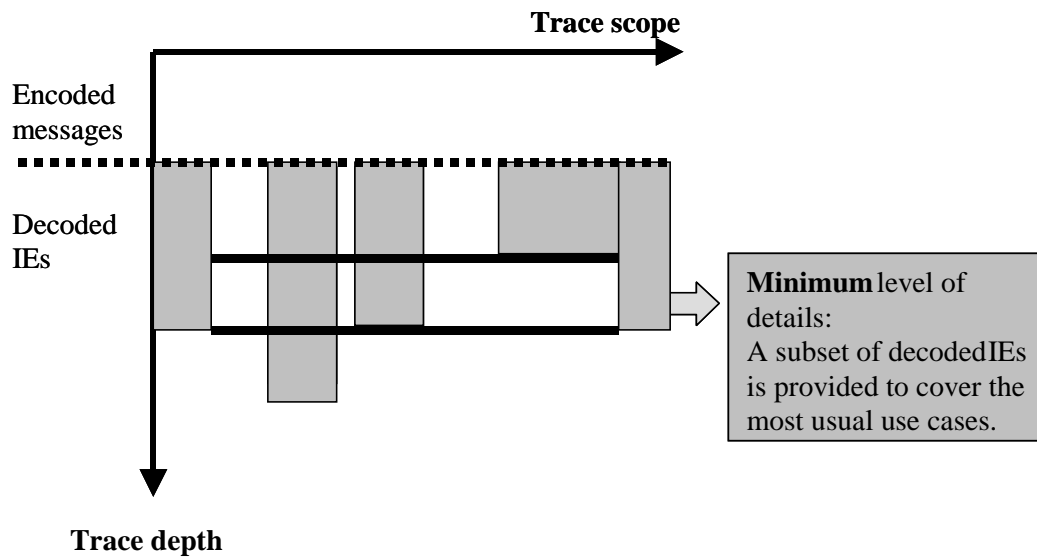

Figure 4.1.2: Minimum (or MinimumWithoutVendorSpecificExtension) Levels of detail of Trace

The Medium (or MediumWithoutVendorSpecificExtension) Levels of detail allow for retrieval of the decoded subset of the IEs contained in the signalling interface messages in the Minimum Level plus a selected set of decoded radio measurement IEs.

The Trace data recorded at each Level is defined in 3GPP TS 32.423 [3].

4.2 Trace high level Architecture

There are two types of activation, management based activation and signalling based activation.

Figure 4.2.1 represents the high-level view of the architecture of Trace Management Based Activation/Deactivation. Figure 4.2.1 is only showing the interfaces in principle a high-level view. Details of Trace activation/deactivation are defined in 3GPP TS 32.422 [2].

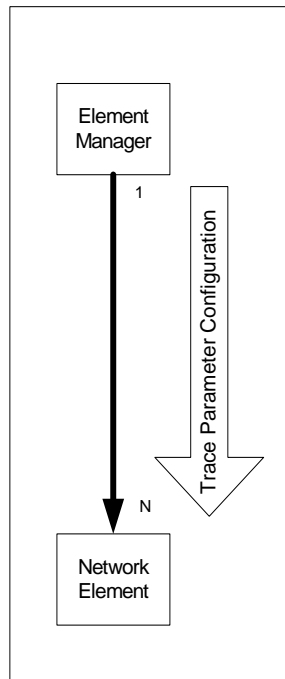

Figure 4.2.1: Architecture for Management Based Activation/Deactivation

Figure 4.2.2 represents the high-level view of the architecture of Signalling Based Activation/Deactivation (non-shared scenario). Figure 4.2.2 is only showing the interfaces in principle. Details of Trace activation/deactivation are defined in 3GPP TS 32.422 [2].

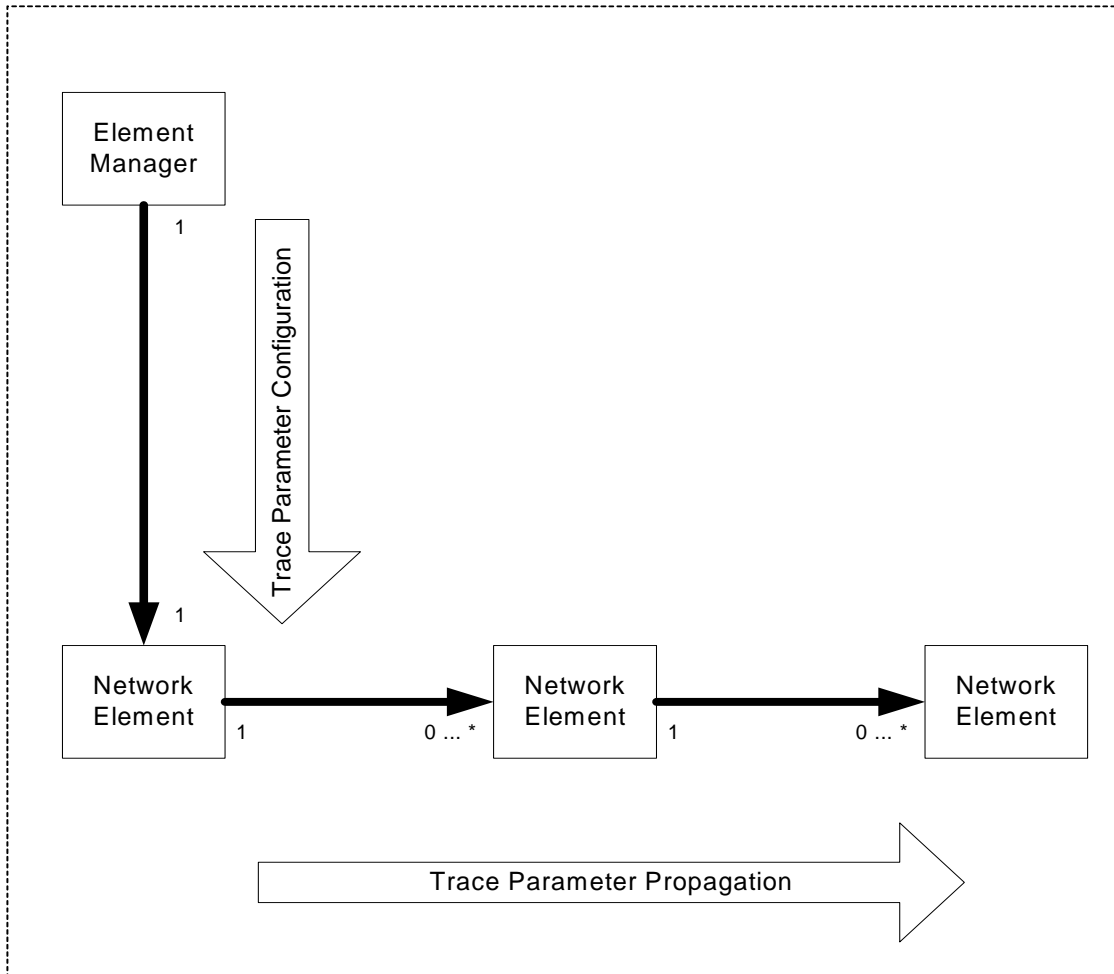

Figure 4.2.2: Architecture for Signalling Based Activation/Deactivation

Figure 4.2.3 represents the high-level view of the architecture of Trace Reporting for System Context A (non-shared scenario). Figure 4.2.3 is only showing the interfaces in principle.

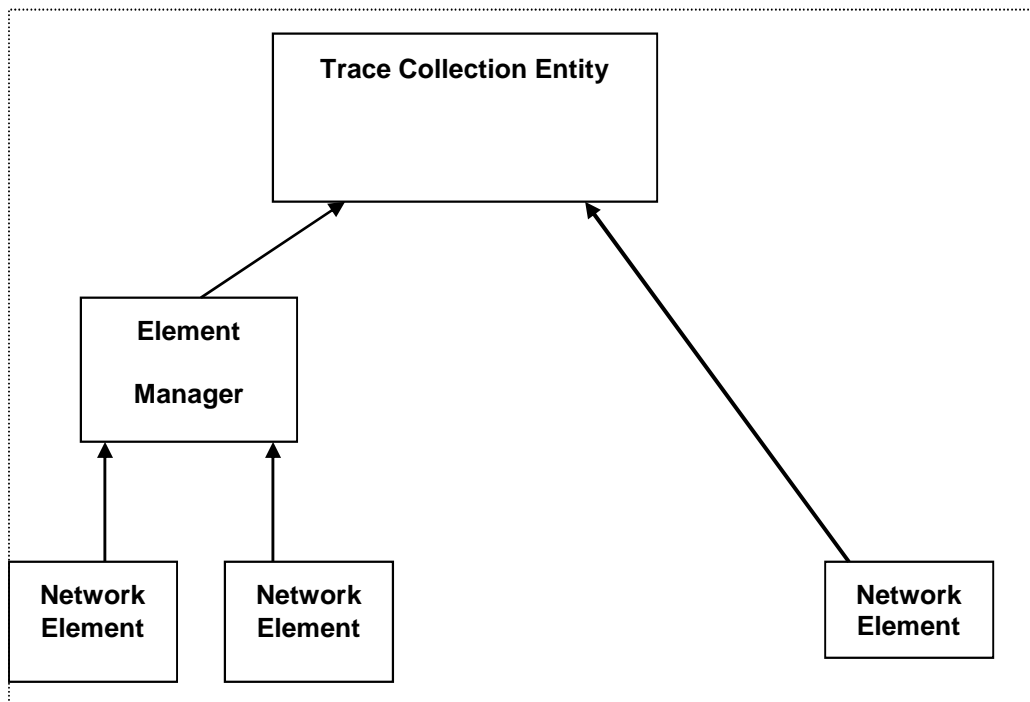

Figure 4.2.3: Architecture for High-level view of Trace Reporting in System Context A

Figure 4.2.4 represents the high-level view of the architecture of Trace Reporting for System Context B (non-shared scenario). Figure 4.2.4 is only showing the interfaces in principle.

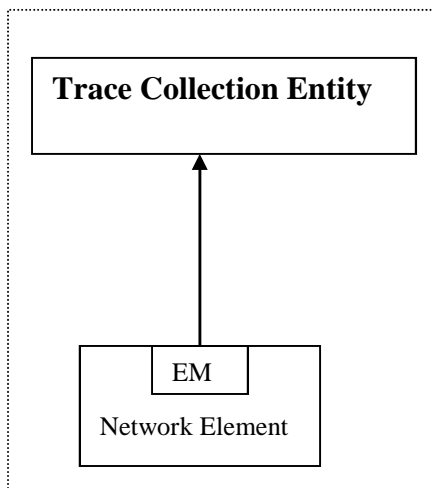

Figure 4.2.4: Architecture for Trace Reporting in System Context B

Editor's note: The placement of the Trace Collection Entity is a deployment matter for the operator. If it is placed outside the operator's secure zone, it is up to the operator to use secure connections to and from the Trace Collection Entity.

4.3 Service Level Tracing for IMS high level Architecture

There are two ways in which to activate service level trace for IMS:

- a) Trace activation at the UE, and
- b) Trace activation at an IMS NE.

Figure 4.3.1 represents the high-level view of the architecture of Signalling Based Activation/Deactivation at the UE required to support Service Level Tracing for IMS. Figure 4.3.1 is only showing the interfaces in principle. Details of Service Level Trace Activation/Deactivation are defined in 3GPP TS 32.422 [2].

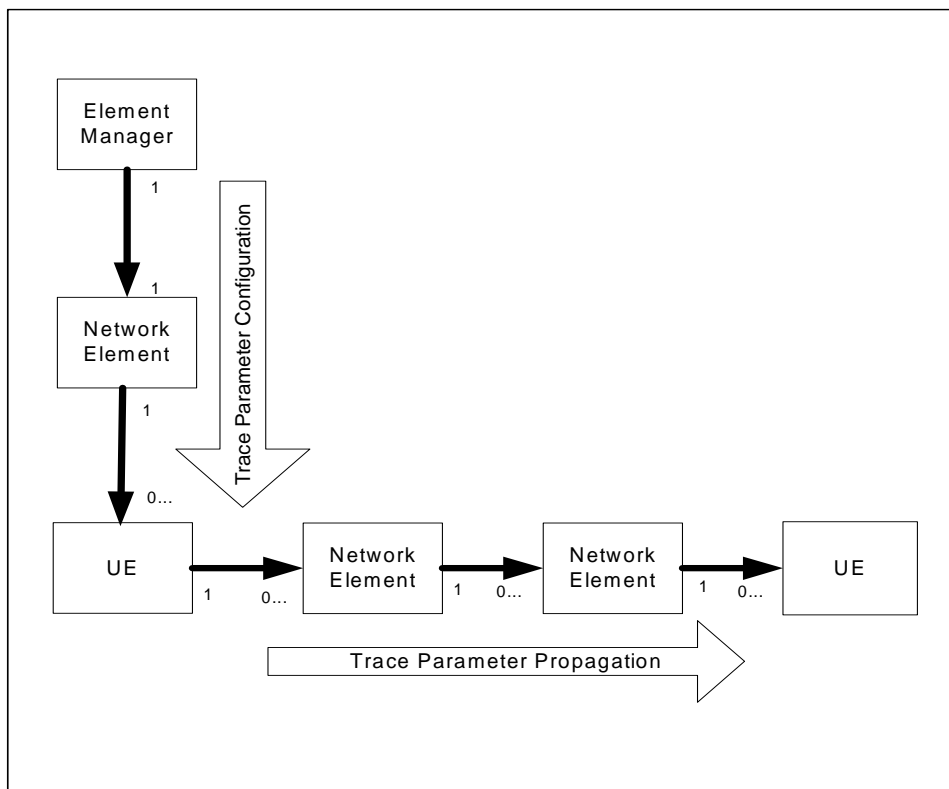

Figure 4.3.1: Architecture for Signalling Based Activation/Deactivation required for Service Level Tracing for IMS at the UE

Figure 4.3.2 represents the high-level view of the architecture of Signalling Based Activation/Deactivation at an IMS NE required to support Service Level Tracing for IMS. Figure 4.3.2 is only showing the interfaces in principle. Details of Service Level Trace Activation/Deactivation are defined in 3GPP TS 32.422 [2].

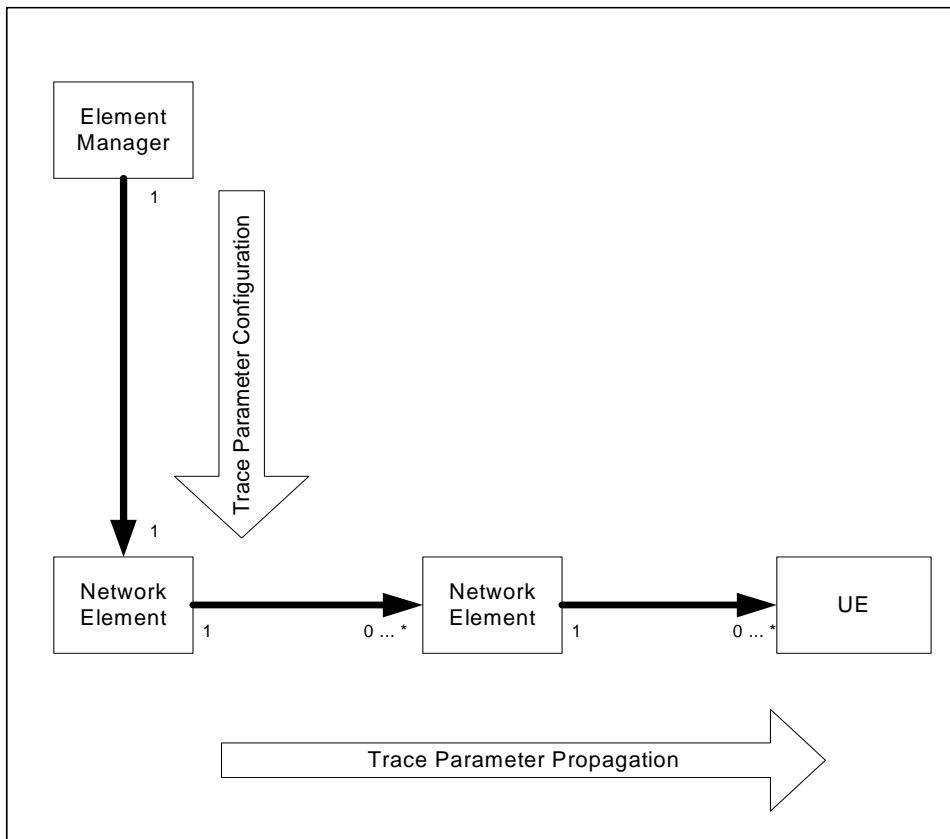

Figure 4.3.2 : Architecture for Signalling Based Activation/Deactivation required for Service Level Tracing for IMS at the IMS NE

Figure 4.3.3 represents the high-level view of the architecture of Trace Reporting for System Context A. Figure 4.3.3 illustrates the reporting context for Service Level Tracing for IMS from the UE and is only showing the interfaces in principle. The reporting context for Service Level Tracing for IMS from the IMS NE is illustrated in Figure 4.2.3: Architecture for High-level view of Trace Reporting in System Context A

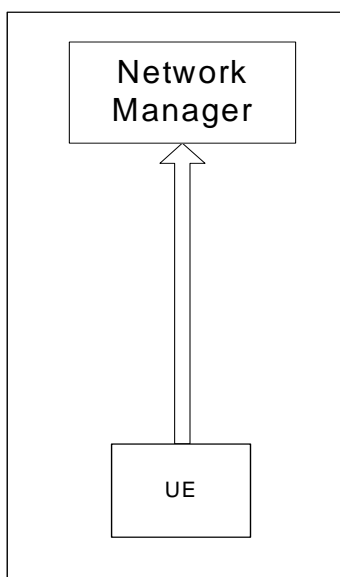

Figure 4.3.3: Architecture for Trace Reporting from UE to support Service Level Tracing for IMS

5 Trace requirements

5.1 General trace requirements

The general high-level requirements for Trace, common to both Management activation/deactivation and Signalling Based Activation/Deactivation, are as follows:

- for the Maximum Level: Trace data encompassing all signalling messages on the different interfaces dedicated to the events of the traced subscriber or UE with their entire content (all IEs) shall be retrieved. The operator can then use an external system (e.g. an Operations System (OS) in TMN terminology) and decode specific information in line with operator requirements.
- for the Minimum Level: a selected subset of IEs shall be retrieved from the signalling interface messages. The Minimum Level provides support for the most common use cases (described in annex A).
- for the Medium Level: a selected Minimum Level subset of IEs from the signalling interface messages and a selected set of radio measurement IEs shall be retrieved.
- for the MaximumWithoutVendorSpecificExtension Level: it is the same as for Maximum level without vendor specific data.
- for the MediumWithoutVendorSpecificExtension Level: it is the same as for Medium level without vendor specific data.
- for the MinimumWithoutVendorSpecificExtension Level: it is the same as for Minimum level without vendor specific data.

The high-level requirements for Trace, specific for Service Level Tracing for IMS are as follows:

The following high-level OMA Service Level Tracing requirements apply. (refer to OMA Service Provider Environment Requirements [9]).

NOTE: Each referenced OMA requirement utilizes its OMA unique identifier within square brackets. Clarification provided to each requirement should be considered applicable to other OMA requirements using the same concepts.

- [SLT-HL-1] with the following clarification:
 - The OMA term *OMA Service Provider Environment (OSPE)* shall be understood as PLMN.
- [SLT-HL-5] with the following clarification:
 - In the context of Service Level Tracing for IMS a Minimum and Maximum level of detail of trace only applies. Trace data for Service Level Tracing at Minimum and Maximum level of detail shall include information associated to *end user visible events*
- [SLT-HL-6] with the following clarification:
 - The OMA term *service chain* shall be understood as the relationship between appropriate IMS elements needed to support a service. The term *service chain* does not imply a strict sequence of events.
 - The source of the logged trace information (e.g. IMS element including S-CSCF) shall be identifiable when the retrieved trace information is analyzed.
- [SLT-HL-10] with the following clarification:
 - IMS elements that do not support Service Level Tracing shall not prohibit the propagation of the Trace Parameter Propagation.
- [SLT-OSR-1]
 - Multiple Service Level Trace instances shall be simultaneously supported by the PLMN and the UE (e.g. several services initiated from the same UE may each have a Trace Recording Session Reference)

5.2 Requirements for Trace data

The high level requirements for Trace data, common to both Management activation/deactivation and Signalling Based Activation/Deactivation, are as follows:

- The Trace records have to contain Information Elements or signalling messages from control signalling and/or the characteristics of the user data. The following list contains the Network Elements and the Traceable interfaces in the NEs where tracing is needed:

- MSC Server: A, Iu-CS, Mc and MAP (G, B, E, F, D, C) interfaces; CAP
- MGW: Mc, Nb-UP, Iu-UP
- HSS: MAP (C, D, Gc, Gr) Cx, S6a and S6d interfaces and location and subscription information
- EIR: MAP(F), S13, S13', MAP (Gf)
- SGSN: Gb, Iu-PS, Gn, MAP (Gr, Gd, Gf), CAP (Ge) Gs, S6d, S4, S3 and S13' interfaces
- GGSN: Gn, Gi and Gmb interfaces
- S-CSCF: Mw, Mg, Mr and Mi interfaces
- P-CSCF: Gm and Go interfaces
- RNC: Iu-CS, Iu-PS, Iur, Iub and Uu interfaces
- BM-SC: Gmb interface
- e-NodeB: S1-MME, X2, Uu
- MME: S1-MME, S3, S6a, S10, S11, S13
- Serving Gateway: S4, S5, S8, S11
- PDN Gateway: S2a, S2b, S2c, S5, S6b, Gx, S8, SGi

- A unique ID within a Trace Session shall be generated for each Trace Recording Session. This is called the Trace Recording Session Reference.

The high level requirements for Trace data applicable for Signalling Based Activation/Deactivation for Service Level Tracing for IMS, are as follows:

- In the context of Service Level Tracing for IMS Trace records have to contain Information Elements or signalling messages or end user visible event from control signalling and/or the characteristics of the user data. The following list contains the IMS NEs and the Traceable interfaces in the NEs where tracing is needed:

- HSS: Sh and Cx interfaces and location and subscription information;
- S-CSCF: ISC, Mw, Mg, Mr and Mi interfaces;
- P-CSCF: Gm and Go interfaces;
- I-CSCF: Mw and Cx interfaces;
- SIP AS: ISC interface;
- MRF: Mr interfaces;
- MGCF: Mg interfaces;
- BGCF: Mi interfaces;

- A unique ID within a Trace Session shall be generated for each Trace Recording Session. This is called the Trace Recording Session Reference. In the context of Service Level Tracing for IMS the Trace Recording Session shall be unique across all IMS NEs within a PLMN.

Changes to existing NEs and interfaces above may be required. These changes would be dependent upon various 3GPP working groups and possibly other non-3GPP industry groups for completion of Trace Session Activation/Deactivation.

For a detailed description of NEs and interfaces above see 3GPP TS 23.002 [4].

5.3 Requirements for Trace activation

5.3.1 Requirements for Trace Session activation

The high level requirements for Trace Session activation, common to both Management activation and Signalling based activation), are as follows:

- In the case of a subscriber Trace, the Trace Session will be activated for a certain subscriber whose identification (IMSI in UTRAN/CS/PS) shall be known in the NEs where subscriber Trace is needed.
In the case of E-UTRAN the IMSI shall not be included in the Trace Parameter Propagation data to the e-NodeB.
- In the case of a UE Trace, the Trace Session will be activated for a certain UE whose identification (IMEI or IMEISV) shall be known in the NEs where UE Trace is needed. In the case of E-UTRAN, neither the IMEI nor IMEISV shall be included in the Trace Parameter Propagation data to the e-NodeB - Trace Session activation shall be possible for both home subscribers and visiting subscribers.
- There are two methods for Trace Session activation: Management activation and Signalling activation.
- For an established call/session within a Network Element, it is optional for the Network Element to start a Trace Recording Session for the associated Subscriber or UE upon receipt of the Trace activation request from the EM.
- A globally unique ID shall be generated for each Trace Session to identify the Trace Session.
This is called the Trace Reference.
The method for achieving this is to divide the Trace reference into Country, Operator, and trace Id.
- Trace Session may be activated from the EM simultaneously to multiple NEs with the same Trace Reference (i.e. same Trace Session).
- The Trace Scope and Depth shall be specified within the control and configuration parameters during Trace Session activation.
- There can be cases in a NE when it receives multiple Trace Session activations for the same connection (e.g. simultaneous CS/PS connections). In these cases the starting time of the Trace Session Activation and the starting time of the first Trace Recording Session is the same using signalling based activation. For these cases there are two different cases for the Trace Session activation in a Network Element when it receives another Trace Session activation to the same subscriber or MS:
 - If the Trace Reference is equal to an existing one, a new Trace Session shall not be started;
 - If the Trace Reference is not equal to an existing one, a new Trace Session may be started.
- The EM shall always provide the trace control and configuration parameters to the appropriate NEs at the time of Trace Session activation.
- The Trace collection entity shall be notified, in case of the Trace Session activation has failed, by the response message with the specific cause (e.g. overload) from the NE on which the Trace Session activation failure happened.

The high-level requirements for Trace Session activation, specific to Signalling Based activation, are as follows:

- Signalling based activation shall be able to capture signalling messages as early in a session as possible, e.g. by means of a piggybacked trace invocation message in the case of a new connection or new bearer setup

For active users, it shall be possible to start trace recording when the trace order is received, by means of a distinct trace invocation message.

The high-level requirements for Trace Session activation, specific to Management activation, are as follows:

- In the case of a subscriber Trace, the Trace Session will be activated for a certain subscriber whose identification (IMSI in UTRAN/CS/PS or Public User Identity in IMS) shall be known in the NEs where subscriber Trace is needed.

In the case of a Cell Traffic Trace, Trace Session activation should be possible for all calls active in a cell or multiple cells without knowledge of the UEs' identification (IMEI or IMEISV).

- In the case of a Cell Traffic Trace, Trace Sessions should be activated for all the NEs where Cell Traffic Trace is specified.
- In the case of Cell Traffic Trace (in a shared network only), a Trace Session shall be started for UEs which are served by the Participating Operator that has made the request to the Master Operator.

The high-level requirements for Trace Session activation specific for Service Level Tracing for IMS are as follows:

The following high-level OMA Service Level Tracing requirements apply [9]:

- [SLT-COM-2] with the following clarification:
 - The OMA term *component* in the context of Service Level Tracing for IMS shall be understood as IMS NE and UE.
- [SLT-HL-2] with the following clarification:
 - The OMA terms *device* and *component* shall be understood as UE and IMS NE, respectively;
 - The IMS NEs HSS, P/I/S-CSCF, AS and UE, apply only.
- [SLT-AC-1] with the following clarification:
 - The OMA term *Authorised Actor* shall be understood as NE, EM or NM;
 - The OMA term *trace indication* shall be understood as Start Trigger Event.
- [SLT-AC-2] with the following clarification:
 - The OMA term *Service Provider* shall be understood as Service Provider;
 - The OMA term *marking request* shall be understood as the ability to send the Trace Parameter Configuration to either the UE or IMS NE.
- [SLT-AC-6]
- [SLT-AC-7] with the following clarification:
 - The OMA term *criteria* shall be understood as Trace Configuration Parameters.

5.3.2 Requirements for starting a Trace Recording Session

The high level requirements for starting a Trace Recording Session, common to both Management activation and Signalling based activation), are as follows:

- It is optional for the NE to start a Trace Recording Session if there are insufficient resources available within the NE.
- The Trace Recording Session Reference shall be unique within a Trace Session.
- The Trace Recording Session should be started after appropriate start trigger events are detected.

The high level requirements for starting a Trace Recording Session, specific to Management activation, are as follows:

- Each NE shall generate its own Trace Recording Session Reference (i.e., independent Trace Recording Sessions).
- Each NE shall start the Trace Recording Session based upon the Trace control and configuration parameters received by the NE in the Trace Session activation.
- In the case of a trace other than Cell Traffic Trace, the correlation of Trace data will be done with a Trace Reference and IMSI / IMEI / IMEISV / Public User Identity.
- The Trace Recording Session can start only when the IMSI (in the case of a subscriber trace), the IMEI / IMEISV (in case of UE trace) or Public User Identity (in the case of IMS) is made available in the NE. In order to trace the early phases of the call the IMSI (in case of subscriber trace), the IMEI / IMEISV (in case of UE trace) or Public User Identity (in case of IMS) shall be made available to the NE as soon as practically possible. E.g. the IMSI and IMEI / IMEISV shall be made available to both Serving RNC and Drift RNC.
- In the case of E-UTRAN the Core Network node that triggers a Trace Recording Session to E-UTRAN shall either:
 - provide a trace log including Trace Reference, Trace Recording Session Reference and the identity of the UE (i.e. IMSI or IMEI(SV)) to the Trace Collection Entity, or
 - provide a notification including Trace Reference, Trace Recording Session Reference and the identity of the UE (i.e. IMSI or IMEI(SV)) to the Trace Collection Entity.
- In the case of a Cell Traffic Trace, the Trace Recording Session should start upon the Trace control and configuration parameters being received by the NEs in the Trace Session activation and the presence of call activity. Furthermore, the the Core Network node that handles the traced session should be requested to:
 - provide a trace log including Trace Reference, Trace Recording Session Reference and the identity of the UE (i.e. IMSI or IMEI(SV)) to the Trace Collection Entity, or
 - provide a notification including Trace Reference, Trace Recording Session Reference and the identity of the UE (i.e. IMSI or IMEI(SV)) to the Trace Collection Entity.
- In the case of a Cell Traffic Trace (in a shared network only), the Trace Recording Session shall only be started for UEs which are served by the Participating Operator that has made the request to the Master Operator.

The high-level requirements for starting a Trace Recording Session, specific for Service Level Tracing for IMS are as follows:

The following high-level OMA Service Level Tracing requirements apply [9]:

[SLT-HL-3] with the following clarification:

- The OMA term *marked* shall be understood as UE or IMS NE that has previously received Trace Parameter Configuration information.
- The OMA term *marking* shall be understood as Trace Parameter Configuration.

[SLT-COM-3] with the following clarification:

- The OMA term *indication for SLT* shall be understood as Start Trigger Event

- The OMA terms *inbound* and *outbound* protocols shall be understood as, for example, inbound SIP and outbound Diameter.

5.4 Requirements for Trace deactivation

5.4.1 Requirements for Trace Session deactivation

The high level requirements for Trace Session deactivation, common to both Management deactivation and Signalling based deactivation, are as follows:

- The Trace Session shall be deactivated using the Trace Reference specified for the Trace Session activation.
- The Trace Session shall be deactivated in all those NEs where it was activated.
- The deactivation of a Trace Session during a Trace Recording Session within a NE may take place anytime after the NE receives the deactivation request until the end of the current Trace Recording Session related to the traced Subscriber or UE.
- Trace Session deactivation in a NE could occur when two simultaneous signalling connections for a subscriber or UE exist. E.g. figure 5.4.1 shows NE 3 having two signalling connections (one of them or both of them are traced with the same Trace Reference) and a Trace deactivation message is received. The Trace Session shall be closed.

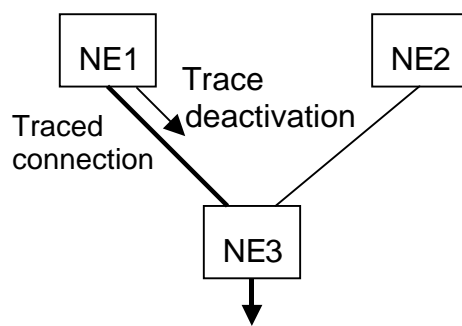

Figure 5.4.1: Trace Session closure

The high-level requirements for Trace Session deactivation specific for Service Level Tracing for IMS are as follows:

The following high-level OMA Service Level Tracing requirements apply [9].

[SLT-COM-2] with the following clarification:

[SLT-AC-1] with the following clarification:

- Deactivation at an IMS NE forming part of an IMS *service chain* shall not prohibit the propagation of the Trace Parameter Propagation.

5.4.2 Requirements for stopping a Trace Recording Session

The high level requirements for stopping a Trace Recording Session, common to both Management deactivation and Signalling based deactivation, are as follows:

- The Trace Recording Session should be stopped after appropriate stop trigger events are detected.
- Trace Session deactivation in a NE could occur when two simultaneous signalling connections for a subscriber or UE exist. E.g. figure 5.4.2 shows NE3 having two signalling connections, but only one connection is traced. If the non-traced connection is released, the Trace Recording Session shall be kept in NE3. If the traced connection is released the Trace Recording Session shall be closed.

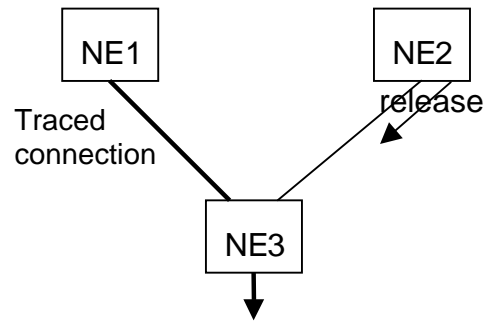

Figure 5.4.2: Trace Recording Session closure

The high level requirements for stopping a Trace Recording Session, specific to Signalling based deactivation, are as follows:

The Trace Recording Session should be stopped after an NE receives the appropriate signalling deactivation message.

The high-level requirements for stopping a Trace Recording Session, specific for Service Level Tracing for IMS are as follows:

The following high-level OMA Service Level Tracing requirements apply [9].

[SLT-AC-3] with the following clarification:

- The implication of un-marking a UE is threefold:
 - a) It prohibits the initiation of further trace recording sessions from that UE or IMS NE (i.e. subsequent services shall not be traced);
 - b) It cancels outstanding Trace Parameter Configuration information on a UE or IMS NE;
 - c) Existing trace recording sessions active in the PLMN may continue until an appropriate Stop Event Trigger.

5.5 Requirements for Trace Data reporting

The high level requirements for Trace Data reporting, common to both Management activation/deactivation and Signalling Based Activation/Deactivation, are as follows (Trace record contents, file formats and file transfer mechanisms are defined in 3GPP TS 32.423 [3]):

- Trace records should be generated in each NE where a Trace Session has been activated and a Trace Recording Session has been started.
- Format of the Trace records sent over Itf-N shall be XML based on the Schema in TS 32.423 [3].
- Trace records should be transferred on the Itf-N to the Network Manager using one of two approaches: direct transfer from NE to NM or transfer from NE to NM via EM.
- Trace records may also be transferred to an external IP address (received in Trace Control and Configuration Parameters) in 3 ways:
 - 1) Direct transfer from NE to IP address
 - 2) Transfer from NE to IP address via EM
 - 3) Transfer from NE to EM. The EM notifies the holder of the IP address that collects the files.
- The Trace Records in a shared node for a Participating Operator's trace request should be collected by the Master Operator's NE and may be delivered through the Master Operator's management system. The Trace records shall be made available to the Participating Operator's management system.

The high-level requirements for stopping a Trace Recording Session, specific for Service Level Tracing for IMS are as follows:

The following high-level OMA Service Level Tracing requirements apply [9].

[SLT-HL-4] with the following clarification:

- Encoded trace information shall be Standard File Format. Standard File Format may not be applicable for encoded trace information at the UE.

[SLT-HL-7] with the following clarification:

- An instance of a service level trace across a PLMN shall be uniquely identifiable using the Trace Recording Session Reference.

[SLT-HL-8]

[SLT-COM-1] with the following clarification:

- Time stamping alone to determine the sequence of IMS NEs performing trace within the *service chain* shall not be used;
- Statistical information shall not be included as part of IMS NE characteristics;
- Service Level Tracing shall apply only to the IMS session layer and not the underlying transport layers.

[SLT-COM-4] with the following clarification:

- An IMS NE, in addition to providing trace information specific to a service that it has traced, may also make available other information, for example, timestamp and throughput information.

[SLT-NI-1] with the following clarification:

- The UE shall expose a standardised interface for Trace Parameter Configuration and the retrieval of trace information. This interface may not be standardized by 3GPP.

[SLT-NI-2] with the following clarification:

- An IMS NE shall transfer Trace records in Standard File Formats via Itf-N.

For transfer of Trace records via Itf-N, FTP or secure FTP shall be used.

The transfer of Trace record from the UE is For Further Study.

5.6 Requirements for Privacy and Security

The high-level requirements for privacy and security, specific for Service Level Tracing for IMS are as follows:

The following high-level OMA Service Level Tracing requirements apply [9].

- [SLT-PRV-1] with the following clarification:
 - Privacy shall be applied across the appropriate Trace Itf-N.
- [SLT-SEC-1]
- [SLT-SEC-2]
- [SLT-SEC-3] with the following clarification:
 - It may not be possible to retrieve Trace information from IMS NEs from outside the PLMN where the IMS NEs reside.
- [SLT-IOP-1] with the following clarification:
 - The propagation of the Trace Parameter Configuration and the Start Trigger event shall be prohibited by the PLMN when e.g. the SIP AS is hosted outside a PLMN.

As the radio access nodes in E-UTRAN are outside an operator's secure domain, the following requirement applies for E-UTRAN as described in 3GPP TS 33.401 [10]:

- [SET-SEC-1] Keys stored inside eNBs shall never leave a secure environment within the eNB. When security key(s) transported on control signalling messages are included in the trace file, the key value(s) shall be removed and replaced with the value "Unavailable".

5.7 Requirements for Charging

The high-level requirements for charging, specific for Service Level Tracing for IMS are as follows:

The following high-level OMA Service Level Tracing requirements apply [9].

- [SLT-CRG-1]

5.8 Use cases for Trace

The operator can use Subscriber and UE Trace for numerous purposes. However, the use cases for Trace can be divided into two basic categories:

- Troubleshooting use cases cover situations where the operator is solving an existing problem in his network;
- Validation testing use cases cover situations where the operator is not solving a known problem but merely analysing, fine-tuning or optimising his network.

A more detailed description for the following use cases for Subscriber and UE Trace can be found in annex A:

- Interoperability checking between UE from different vendors;
- QoS profile checking for a subscriber after a subscriber complaint;
- Malfunctioning UE;
- Checking radio coverage in a certain area;
- Testing new features;
- Fine-tuning and optimisation of algorithms or procedures.

The operator can use Service Level Tracing for IMS for numerous purposes. However, the use cases for Trace can be divided into two basic categories:

- Troubleshooting use cases cover situations where the operator is solving existing problems with services offered to their subscribers.
- Validation testing use cases cover situations where the operator is not solving a known problem but performing service regression and automated service testing.

A more detailed description of the following use cases for Service Level Tracing can be found in annex A:

- Automated testing of service provider services;
- Regression testing following a network fix;
- Service fault localization within a Service Provider's network;
- Service fault localization when a service is hosted by a third party Service Provider.

6 Requirements for managing MDT

6.1 Business Level Requirements

REQ-MDT-CON-1 The Operator shall be able to collect measurements for Network Performance Management purposes from UEs within their network.

REQ-MDT-CON-2 The collected measurements shall be made available in a centralised entity.

REQ-MDT-CON-3 Operator shall be able to select specific set of subscribers for the measurement collection based on IMSI.

REQ-MDT-CON-4 Operator shall be able to select specific set of devices for the measurement collection based on IMEI(SV).

REQ-MDT-CON-5 Operator shall be able to select specific set of devices for the measurement collection based on geographical area.

REQ-MDT-CON-6 Operator shall be able to select specific set of devices for the measurement collection based on device capabilities.

REQ-MDT-CON-7 Operator shall be able to select specific set of subscribers based on IMSI and a geographical areas for the measurement collection.

REQ-MDT-CON-8 Operator shall be able to select specific set of devices based on IMEI(SV) and a geographical area for the measurement collection.

REQ-MDT-CON-9 Operator shall be able to configure set of device capabilities and a geographical area for the measurement collection.

REQ-MDT-CON-10 Operator shall be able to select specific set of subscribers based on IMSI and a set of device capabilities and a geographical area for the measurement collection.

REQ-MDT-CON-11 Operator shall be able to select specific set of device IMEI(SV) and capabilities and a geographical area for the measurement collection.

REQ-MDT-CON-12 Operator shall be able to select set of subscribers based on IMSI and a set of device capabilities for the measurement collection

REQ-MDT-CON-13 Operator shall be able to select specific set of device IMEI(SV) and capabilities for the measurement collection.

REQ-MDT-CON-14 The operator shall be able to configure the duration of the measurement collection.

REQ-MDT-CON-15 The operator shall be able to configure the UE measurement types and events for collection.

REQ-MDT-CON-16 The operator shall be able to configure the type of UE measurement reporting and log formats i.e. raw measurement results or type of measurement aggregation (e.g. statistical aggregation of raw measurement results, sampling of raw measurement results, etc.)

REQ-MDT-CON-17 The management of MDT shall be independent from the management of SON functionalities

REQ-MDT-CON-18 The management of UE based network performance measurements shall allow the network operator to control whether or not it is possible to link a measurement result and related information (e.g. location information) to the user terminal type ID (i.e. IMEI-TAC).

REQ-MDT-CON-19 An operator that uses more than one PLMN shall be able to activate MDT in each of those PLMN and continue MDT cross its own PLMN IDs.

NOTE: MDT data can be collected by a network operator operating with a set of PLMN_IDs in different countries, but under the same common user privacy agreement in different countries in the same legal privacy protection domain.

REQ-MDT-CON-20 The operator shall be able to request collection of positioning information related to UE measurements.

REQ-MDT-CON-21 Operator shall be able to correlate the location information with the MDT UE measurements.

REQ-MDT-CON-22 MDT function shall support RAN sharing scenarios.

REQ-MDT-CON-23 The TCE used to collect MDT data shall be controlled by the same operator, as the operator that the user has given his consent to.

REQ-MDT-CON-24 Operator shall be able to minimize the amount of redundant MDT data.

REQ-MDT-CON-25 For area based MDT data collection, operator shall be able to specify the desired amount of MDT data and the desired number of UEs over period of time.

REQ-MDT-CON-26 The MOP shall be able to select UEs according to the POP intention.

REQ-MDT-CON-27 The recorded Subscriber and Equipment Trace data related to a particular POP shall be delivered to that POP but no other POP.

REQ-MDT-CON-28 The Operator shall be able to collect MBSFN UE measurements.

6.2 Specification level requirements

6.2.1 Logged MDT and Immediate MDT requirements

All requirements are valid for Logged MDT and Immediate MDT functionality if not mentioned otherwise:

REQ-MDT-FUN-01 It shall be possible to collect UE measurements based on one or more IMEI(SV) number.

REQ-MDT-FUN-02 It shall be possible to collect UE measurements based on one or more IMSI number.

REQ-MDT-FUN-03 It shall be possible to collect UE measurement logs preceding and following a particular event (e.g. radio link failure).

REQ-MDT-FUN-04 Each UE measurement result shall be linked to a time stamp. Accuracy of time information (absolute time, relative time) is FFS in RAN. (Editor's Note: FFS in RAN)

REQ-MDT-FUN-05 The solutions for collecting UE measurements for the purpose of minimization of drive tests shall be able to work independently from SON support in the network.

REQ-MDT-FUN-06 It shall be possible to collect UE measurements in one or more cells or TA/RA/LA.

REQ-MDT-FUN-07 It shall be possible to collect UE measurements based on one or more IMSI in one or more cells or TA/RA/LA.

REQ-MDT-FUN-08 It shall be possible to collect UE measurements based on one or more IMEI(SV) in one or more cells or TA/RA/LA.

REQ-MDT-FUN-09 It shall be possible to configure UE measurement types, and triggering conditions under which UE measurements would be collected for MDT.

REQ-MDT-FUN-10 Void.

REQ-MDT-FUN-11 It shall be possible to configure the condition of MDT data collection based on certain device capability information in one or more cells or in TA/RA/LA.

REQ-MDT-FUN-12 It shall be possible to configure MDT data collection based on one or more IMSI in one or more cells or TA/RA/LA with a set of device capability information.

REQ-MDT-FUN-13 It shall be possible to configure MDT data collection based on one or more IMEI(SV) in one or more cells or TA/RA/LA with a set of device capability information.

REQ-MDT-FUN-14 It shall be possible to configure MDT data collection based on one or more IMEI(SV) with a set of device capability information.

REQ-MDT-FUN-15 It shall be possible to configure MDT data collection based on one or more IMSI with a set of device capability information.

REQ-MDT-FUN-16 It shall be possible to activate a Trace Session for MDT data collection (or UE measurement collection for MDT purpose) independently from other mobility related performance measurements and call trace collection.

REQ-MDT-FUN-17 It shall be possible to deactivate MDT data collection by using Trace Reference.

REQ-MDT-FUN-18 It shall be possible to create a combine Trace Session for UE measurement collection and for subscriber and equipment/cell trace.

REQ-MDT-FUN-19 Void.

REQ-MDT-FUN-20 MDT activation shall be supported for a UE belonging to any PLMN of the same Operator.

REQ-MDT-FUN-21 MDT data collection shall continue if a user is changing PLMN and the target PLMN is owned by the same operator.

REQ-MDT-FUN-22 It shall be possible to collect positioning data related to UE measurements, which can be either geographical coordinates or raw positioning measurements sufficient to be input for a post processing positioning algorithm.

REQ-MDT-CON-23 It shall be possible for IRPManager to correlate MDT UE measurements with location information.

NOTE: There may be regulatory obligation to delete MDT data after processing.

REQ-MDT-FUN-24 The PLMN where TCE collecting MDT data resides shall match the RPLMN of the UE providing the MDT data.

REQ-MDT-FUN-25 In the case of Area Based MDT the MOP shall be able to select UEs according to the POP intention.

REQ-MDT-FUN-26 The recorded Subscriber and Equipment Trace data related to a particular POP shall contain information so that it can be sent to that POP.

6.2.2 Logged MBSFN MDT requirements

Requirements in section 6.2.1 that apply to MBSFN MDT are as follows:

REQ-MDT-FUN-01

REQ-MDT-FUN-02

REQ-MDT-FUN-03

REQ-MDT-FUN-04

REQ-MDT-FUN-05

REQ-MDT-FUN-06

REQ-MDT-FUN-07

REQ-MDT-FUN-08

REQ-MDT-FUN-09

REQ-MDT-FUN-11

REQ-MDT-FUN-12

REQ-MDT-FUN-13

REQ-MDT-FUN-14

REQ-MDT-FUN-15

REQ-MDT-FUN-20

REQ-MDT-FUN-21

REQ-MDT-FUN-24

REQ-MDT-FUN-25

REQ-MDT-MBSFN-FUN-1 It shall be possible to activate a Session for Logged MBSFN MDT data collection independently from other mobility related performance measurements and call trace collection.

REQ-MDT-MBSFN-FUN-2 It shall be possible to configure MBSFN MDT data collection based on certain device capability information in specific MBSFN area(s).

REQ-MDT-MBSFN-FUN-3 It shall be possible to deactivate Logged MBSFN MDT data collection by using Trace Reference.

REQ-MDT-MBSFN-FUN-4 It shall not be possible to combine Logged MBSFN MDT session with any other trace sessions.

7 Requirements for managing RLF reports

7.1 Business level requirements

REQ-RLF-CON-1 The Operator shall be able to collect RLF reports from eNBs within their network.

REQ-RLF-CON-2 The collected RLF reports shall be made available in a centralised entity.

REQ-RLF-CON-3 The Operator shall be able to select certain areas for collecting RLF reports.

7.2 Specification level requirements

REQ-RLF-FUN-01 It shall be possible to collect RLF reports in one or more eNodeBs.

REQ-RLF-FUN-02 It shall be possible to activate a Trace Session for RLF data collection independently from other Trace jobs.

Annex A (informative): Trace use cases

A.1 Use case #1: multi-vendor UE validation

A.1.1 Description

The aim of this use case is to check how different vendor's UEs are working (e.g. in field testing) in the mobile network or to get detailed information on the UE.

The study can be started by an initiative from operator for verification of UE from different vendors (e.g. testing how the UE fulfils the requirements set by the standards).

The operator can perform the test using test UEs or tracing subscribers' mobiles.

A.1.2 Example of required data for this use case

The Trace parameters required to cover use case #1 are listed below:

- Tracing is needed in the Radio Network (RNC) or in the Core Network (MSS, SGSN);
- The identification of the Trace case shall be IMEI or IMEISV (and possibly IMSI);
- The level of details usually is to get the most important IEs from the signalling messages (Medium Level) or all messages with their encoded IEs (Maximum Level).

The traceable protocols are:

- In RNC: RRC, NBAP, RNSAP, RANAP.
- In MSS/SGSN: DTAP messages.

A.2 Use case #2: subscriber complaint

A.2.1 Description

The aim of this use case is to check how the complaining subscriber's services are working, to get information on the services in order to find out the reason for the complaint.

The study can be started after a subscriber is complaining at his/her home or visited operator that some of the service to which he/she subscribed is not working. E.g. the subscriber:

- cannot make calls;
- cannot use some supplementary service;
- does not get the negotiated QoS level (e.g. Mobile subscriber activates video-streaming application to watch the latest sport events and every time the subscriber tries to connect to the service the system disconnects the subscriber's UMTS bearer).

As the Trace is activated for a subscriber, the signalling based Trace Session activation shall be used, as the location of the subscriber is not known.

A.2.2 Example of required data for this use case

The Trace parameters required to cover the use case #2 are listed below:

- The list of NEs where tracing may be needed depends on the service being complained about by the subscriber. For this use case, tracing should be possible in all network elements, such as: HSS, MSS, RNC, MGW, SGSN, GGSN.
 - The identification of the subscriber in a Trace is IMSI in UTRAN/CS/PS. The identification of the UE in a Trace is IMEI or IMEISV.
 - The data includes those Information Elements from the signalling messages, which are related to the service(s) being complained about by the subscriber (Medium Level).

Example cases, which can be the basis for subscriber complaint:

1. The subscriber's CS call is misrouted

This illustrates an instance where a subscriber complains that his calls are being cross-connected (or misrouted). Such a complaint involves setting up a Trace at all the 3GPP standardised interfaces being handled by the MSC. However, the Trace functionality shall not cover MSC internal or vendor proprietary interfaces. The Trace record shall need to have the dialled number and connected number.

2. The subscriber's call is dropped

Tracing data is required from the radio network (UTRAN) or from the core network (MSS, SGSN, GGSN). In the radio network the radio coverage shall be checked. See use case #4 (checking radio coverage). Beside the radio coverage, other information can be useful as well, like RLC parameter, power information (OLPC or RRC measurement report), error ratios (BLER / BER, SDU error ratio), etc. Tracing in the core network is needed also, if the problem is not in the radio network. E.g. in case of PS domain the call can be dropped by the application due to the long delays or congestions in TCP layer or due to bad QoS. Thus in SGSN the requested and negotiated QoS parameters should be included in the Trace record.

3. The received QoS level is less than the negotiated level.

To be able to solve the possible problem Tracing data is required from HSS, SGSN, GGSN, and UTRAN. Furthermore in case of problem in CS calls tracing in MGW shall be performed.

From HSS Trace data the operator can monitor whether the subscriber's authentication to the network is successful, and what kind of QoS parameters are allowed to the subscriber. From SGSN Trace data the operator can monitor PDP context creation request from mobile. Request seems to contain legal QoS profile (incl. Maximum bandwidth, guaranteed bandwidth etc) and the local resources in SGSN are available to provide the service as requested by the subscriber. From UTRAN Trace data the operator can monitor whether the maximum bandwidth and guaranteed bandwidth, requested by SGSN, acceptable for UTRAN. Thus to check whether UTRAN can provide and maintain the requested radio access bearer services. From GGSN Trace data the operator can monitor PDP context activation between SGSN and GGSN. If the problem is in the CS domain the MGW Trace can provide the QoS data.

A.3 Use case #3: malfunctioning UE

A.3.1 Description

The aim of this use case is to check a UE, which is not working correctly.

The study can be initiated by the operator when he/she suspects that a UE not working according to the specifications or he/she would like to get more information on a specific UE, which is on the grey or black EIR list.

A.3.2 Example of required data for this use case

The Trace parameters required to cover the use case #3 are listed below:

- UE Tracing may be needed in the Radio Network (UTRAN) or in the Core Network (MSS, SGSN).
- The identification of the subscriber in a Trace is IMSI. The identification of the UE in a Trace is IMEI or IMEISV.
- The level of details depends on the operator needs (either Minimum Level or Medium Level).

The malfunction of UE in UTRAN can occur in different places. The problem can be in basic RRC and RANAP signalling, Radio Bearer procedures, Handover procedures, Power control etc.

Therefore, all RRC, RANAP, NBAP, RNSAP signalling procedures, transmission powers, error ratios (BLER / BER, SDU error ratio) and retransmission can be included in the Trace records.

A.4 Use case #4: checking radio coverage

A.4.1 Description

This use case aims at checking the radio coverage on a particular network area.

This study can be started by an initiative from operator for testing radio coverage on a particular geographical area following network extension for instance (e.g. new site installation).

The operator can perform a drive test on the new site area, and check that radio coverage is correct, or may collect Cell Traffic Trace data on all of the cells active in the area of interest.

The other options for collecting information on radio coverage is to collect RLF reports generated by the UE in an E-UTRAN network. .

A.4.2 Example of required data to cover use case #4

The DL radio coverage can be checked using the values of CPICH Ec/No and RSCP measured by the mobile on the cells in the active set and the monitored set. These measurements are sent to the RNC through the RRC message MEASUREMENT REPORT.

For E-UTRAN the RLF reports contained in the UE Information Response message provide the radio condition in terms of RSRP and RSRQ values when the Radio Link failure happened together with a location information.

The UTRAN Trace record intra frequency measurement contains the required information.

The UTRAN Trace record inter frequency, and inter RAT measurements can also be used to check radio coverage with other frequencies or systems.

After a network extension, the operator can check that Ec/No and RSCP levels on the new site area are the expected ones, and there is no coverage hole.

The following Trace parameters are required to cover use case #4:

- The type of NE to Trace is RNC or eNB.
- The identification of the subscriber in a Trace is IMSI. The identification of the UE in a Trace is IMEI or IMEISV.
- In the case of a Cell Traffic Trace, the identification of the cells where Trace data is to be collected.
- In case of RLF report collection the list of eNodeBs where the RLF reports are collected.
- The Trace data to retrieve shall contain the messages with all IEs that are relevant for radio coverage.

A.5 Use case #5: testing a new feature

A.5.1 Description

This use case aims at testing the implementation of a new feature in the network before its general deployment. The functionality can be either a standard feature or a vendor/operator specific feature.

This study is started by an initiative from the operator.

The operator can perform a drive test on the area where the feature is introduced, and check its good behaviour as well as its benefits, in term of quality or capacity. He can also rely on subscribers' Trace data when they use the feature to be tested.

A.5.2 Example of required data to cover use case #5

Depending on the feature, the list of NEs to Trace, as well as the level of details can be different.

For a feature concerning Core and UTRAN networks, for instance hard handover, SRNS relocation, or new UMTS bearer service, the operator needs to activate Trace on several NEs.

Then, the operator can be interested in:

- Only the protocol messages generated by the feature; or
- The impact of the new feature introduction on the network, for instance, the radio coverage, the capacity, the quality, or the behaviour of the existing algorithms.

In this last case, the operator needs more detailed data, for instance messages with all (Maximum Level) or part of the IEs (Minimum Level).

The following Trace parameters are required to cover use case #5:

- The types of NEs to Trace are NEs that can be traced related to the feature.
- The identification of the subscriber in a Trace is IMSI. The identification of the UE in a Trace is IMEI or IMEISV.
- The Trace data to retrieve can be either only the protocol messages (Maximum Level) or the messages with all or part of the IEs (Minimum Level).

A.6 Use case #6: fine-tuning and optimisation of algorithms/procedures

A.6.1 Description

Subscriber and UE Trace is part of the optimisation process. Trace data are used to get feedback on the network quality and capacity after optimisation operations like parameter fine-tuning, or new network design. Each intervention to improve the network behaviour can be confirmed both by measurement data and Trace data.

This study is started following an initiative from the operator.

The operator can perform a drive test on the area and/or activate a Cell Traffic Trace where the optimisation has been performed, and check its good behaviour as well as its impact on the network. He can also rely on subscribers' Trace data when they use the network to be optimised.

A.6.2 Example of required data to cover use case #6

Depending on the optimisation operation, the list of NEs to Trace, as well as the level of details can be different. But generally, fine-tuning activities like scrambling code plan, handover and relocation algorithms, or call admission algorithm optimisation concern a very specific part of the network.

To cover this use case, the operator is usually searching for the highest level of details, on specific NEs.

The following Trace parameters are required to cover use case #6:

- The types of NEs to Trace are any NE that can be traced related to the network to be optimised.
- The identification of the subscriber in a Trace is IMSI. The identification of the UE in a Trace is IMEI or IMEISV.
- In the case of a Cell Traffic Trace, the identification of the cells where Trace data is to be collected.
- The Trace data to retrieve are the messages in encoded format with all (Maximum Level) or part of the IEs (Minimum Level).

A.7 Use case #7: Automated testing of Service Provider services

A.7.1 Description

For a detailed description of this use-case see OMA Service Provider Environment Requirements [9].

A.8 Use case #8: Regression testing following a network fix

A.8.1 Description

For a detailed description of this use-case see OMA Service Provider Environment Requirements [9].

A.9 Use case #9: Service fault localization within a Service Provider network

A.9.1 Description

For a detailed description of this use-case see OMA Service Provider Environment Requirements [9].

A.10 Use case #10: Service fault localization when a service is hosted by a third party Service Provider

A.10.1 Description

For a detailed description of this use-case see OMA Service Provider Environment Requirements [9].

A.11 Use case #11 Analysing drop calls in E-UTRAN

A.11.1 Description

One of the important KPIs in an operator's network is the call drop KPI. A call drop KPI is defined also in 3GPP TS 32.450 [12]. The call drop KPI indicates in percentage of how many successfully established calls have been dropped. This is a crucial indicator about the quality of the network that has clear effects to the user experience.

Therefore one of the most important targets for operator is to minimize the value of the Call drop rate KPI. The root cause of a dropped call is typically a radio link failure or a handover failure. Both of these failures currently reported by the UE in the RLF reports, which additionally contain the radio conditions at the time the failure happened. Therefore the RLF reports are very important input for operators to determine the reasons for degradations in Call Drop KPI. In addition the RLF reports combines the radio conditions with location information, therefore it can serve as a valuable input for analysis how to decrease the Call Drop KPI.

A.11.2 Example of required data to cover use case #11

For further analysis of drop calls information is required about the radio conditions of the radio network when the drop calls happens. In E-UTRAN the ideal data can be collected by utilising the RLF reports defined in TS 37.320 [11]. RLF reports contain the RSRP and RSRQ values of the radio conditions at the time when the Radio Link Failure happens that can lead in most of the cases to a drop call. The RLF report contains also the time and location of the RLF event.

A.12 Use case #12 Periodical sampling of network performance

A.12.1 Description

For management purpose, an operator need to measure statistical network performance e.g. overall coverage status, overall voice call and data session performance and so on. The data collected could include measurements, such as Ec/No and RSCP for case of UMTS and RSRP and RSRQ for case of E-UTRAN, and statistical business level KPIs such as sampled call drop rate and application layer throughput. By periodically sampling these network performance data, managers of the operator can monitor overall performance of the network and compare performance differences between areas or periods. The statistical data sampling can be performed periodically e.g. weekly or monthly. The drive test fleet's scale makes the amount of data samples under operators control.

MDT can be used to replace or reduce drive test in this case. It is necessary for the MDT task to collect measurements in a way similar as the drive test do. To prevent unnecessary waste of network resources, operators need to specify the desired maximum number and amount of data samples collected through an MDT task. There is no need to notify the operator when the max number or amount is reached because that will not trigger any action of the operator. It is necessary for the operators to specify the desired minimum number of UEs and amount of data samples collected in a MDT job so that the data collected can meet the business and management requirements. If a MDT job can not collect minimum amount of data in a given period of time, the operator need to be notified quickly at the end of the time period given by the operator so he can decide if he will need to send a drive test team in the field to replace the MDT job.

A.12.2 Example of required data to cover use case #12

Ideally, the data collected should include all measurements taking place in a drive test, such as Ec/No and RSCP for UMTS and RSRP and RSRQ for E-UTRAN, and statistical business level KPIs such as sampled call drop rate and application layer throughput. It is not possible to ask a normal UE to perform similar task. To make MDT a basic replacement for drive test, UE measurement such as Ec/No and RSCP for UMTS and RSRP/RSRQ for E-UTRAN should be reported.

It shall also be possible for MDT to facilitate the introduction of future technology to collect business level KPIs e.g. sampled call drop rate and application layer throughput.

A.13 Use case #13 Differentiation of area based MDT data by terminal type

A.13.1 Description

For analysis of area based MDT data, it's useful to differentiate the MDT data which are collected from different terminal types. For example, it allows operators to analyze whether the poor network performance is caused by a specific terminal type.

For privacy consideration of MDT data, operator shall also be able to select whether the MDT data should be reported with or without the user terminal type information.

A.13.2 Example of required data to cover use case #13

The IMEI-TAC could be used together with MDT data and operators could use the information to analyze whether the poor network performance is caused by network or specific terminal types.

A.14 Use case #14 Subscriber complaint about MBMS service in the eUTRAN network

A.14.1 Description

When a subscriber complains about their MBMS service, signalling based MDT for that particular user can be triggered to analyse and troubleshoot the issue. Operator may also want to analyse the performance or issues in the network by looking at per subscriber MBSFN measurements.

A.14.2 Example of required data to cover use case #14

The MBSFN MDT measurements defined in TS 37.320 [11] are required for analysing MBMS service quality in the indicated area and for trouble shooting per user MBMS service. The measurement quantities for E-UTRA MBSFN measurement logging are fixed and consist of MBSFN RSRP, MBSFN RSRQ, BLER for signalling and BLER for data per MCH, in addition to the measurement quantities for downlink pilot strength measurements.

The MBSFN measurement results consist of, per MBSFN area where MBMS service is received:

- MBSFN area identity.
- Carrier frequency.
- MBSFN RSRP.
- MBSFN RSRQ.
- MCH BLER for signalling.
- MCH BLER for data, and related MCH index.

A.15 Use case #15 Check MBMS service quality and performance of the eUTRAN Network

A.15.1 Description

The operator needs information for analysing signal strength, signal quality and block error rates for MBMS reception and quality. Logged MBSFN MDT data is needed to support network verification, re-planning of MBSFN areas, and optimization of MBSFN operation parameters.

A.15.2 Example of required data to cover use case #15

The MBSFN MDT measurements defined in TS 37.320 [11] are required for analysing MBMS QoS in the indicated area and for trouble shooting per user MBMS service. The measurement quantities for E-UTRA MBSFN measurement logging are fixed and consist of MBSFN RSRP, MBSFN RSRQ, BLER for signalling and BLER for data per MCH, in addition to the measurement quantities for downlink pilot strength measurements.

The MBSFN measurement results consist of, per MBSFN area where MBMS service is received:

- MBSFN area identity.
- Carrier frequency.
- MBSFN RSRP.
- MBSFN RSRQ.
- MCH BLER for signalling.
- MCH BLER for data, and related MCH index.

Annex B (informative): Change history

Change history								
Date	TSG #	TSG Doc.	CR	Rev	Subject/Comment	Cat	Old	New
Jun 2002	SA_16	SP-020330	--	--	Submitted to SA #16 for Information	--	1.0.0	
Dec 2002	SA_18	SP-020755	--	--	Submitted to SA #18 for Approval	--	2.0.0	6.0.0
Mar 2003	SA_19	SP-030147	0001	--	Corrections to Trace requirements - alignment with SA2's 23.002	F	6.0.0	6.1.0
Dec 2003	SA_22	SP-030612	0002	--	Correction of IMS subscriber identification for Trace	F	6.1.0	6.2.0
Mar 2004	SA_23	SP-040116	0003	--	Correction in Trace high level architecture	F	6.2.0	6.3.0
Sep 2004	SA_25	SP-040542	0004	--	Removal of GERAN from Rel-6 32.42x series of Trace specifications	F	6.3.0	6.4.0
Dec 2004	SA_26	SP-040770	0005	--	Remove requirement for having ASN.1 as Trace record format	C	6.4.0	6.5.0
Dec 2004	SA_26	SP-040770	0006	--	Remove in Rel-6 the signalling based Trace in IMS due to missing SIP signalling support from CN1/IETF	C	6.4.0	6.5.0
Mar 2005	SA_27	SP-050043	0007	--	Remove ambiguity on the file format for trace data at the Network Elements (NEs)	F	6.5.0	6.6.0
Mar 2005	SA_27	SP-050043	0008	--	Correction to the Scope	F	6.5.0	6.6.0
Mar 2005	SA_27	SP-050043	0009	--	Correct the list of interfaces trace parameter – Align with 32.422 and 32.423	F	6.5.0	6.6.0
Jun 2005	SA_28	SP-050294	0010	--	BM-SC Network Element and Gmb interface addition for MBMS tracing	B	6.6.0	6.7.0
Sep 2005	SA_29	SP-050623	0011	--	Add support for UTRAN TDD - Declare RAT Type	B	6.7.0	7.0.0
Mar 2006	SA_31	SP-060100	0012	--	Introduction of Service Level Tracing for IMS	B	7.0.0	7.1.0
Sep 2006	SA_33	SP-060552	0013	--	Add Cell Traffic Trace capability to 32.421 Trace concepts and requirements	C	7.1.0	7.2.0
Sep 2007	SA_37	SP-070614	0014	--	Add extended trace depth to include Vendor Specific Extension (VSE)	C	7.2.0	8.0.0
Sep 2007	SA_37	SP-070614	0015	--	Add LTE nodes and interfaces	C	7.2.0	8.0.0
Mar 2008	SP-39	SP-080069	0016	--	Add trace functionality for E-UTRAN	B	8.0.0	8.1.0
Mar 2008	SP-39	SP-080069	0017	--	Add trace activation failure response	B	8.0.0	8.1.0
Jun 2008	SP-40	SP-080329	0018	--	Introduction of UE identifiers for trace in E-UTRAN	C	8.1.0	8.2.0
Sep 2008	SP-41	SP-081260	0019	--	Change the description for Trace Recording Session Reference	C	8.2.0	8.3.0
Dec 2008	SP-42	SP-080846	0020	--	Correction of trace depth extensions	F	8.3.0	8.4.0
Jun 2009	SP-44	SP-090289	0022	--	Add missing Trace Interface for SGSN and HSS list	F	8.4.0	8.5.0
Dec 2009	-	-	-	-	Update to Rel-9 version (MCC)	--	8.5.0	9.0.0
Mar 2010	SP-47	SP-100034	0024	--	Align the handling of security keys for E-UTRAN with 33.401	A	9.0.0	9.1.0
Sep 2010	SP-49	SP-100492	0025	--	Adding Requirements for managing UE based network performance measurements	F	9.1.0	10.0.0
Dec 2010	SP-50	SP-100833	0026	1	Add requirements for trace data of S13, S13' interfaces	C	10.0.0	10.1.0
Dec 2010	SP-50	SP-100833	0027	1	Correcting the Identification of IMS Subscriber Tracing - Align with 32.422	F	10.0.0	10.1.0
Mar 2011	SP-51	SP-110102	0029	3	Add requirements for security and privacy of UE-based Network Performance Measurements / MDT as required by SA3 (Security)	C	10.1.0	10.2.0
Mar 2011	SP-51	SP-110102	0030	-	Change "UE based network performance measurements" to "MDT" - Align cross-3GPP terminology on MDT work	F	10.1.0	10.2.0
Mar 2011	SP-51	SP-110095	0031	-	Add the missing interfaces for EIR	B	10.1.0	10.2.0
Mar 2011	SP-51	SP-110095	0032	1	Clarify and cleanup MDT requirements	F	10.1.0	10.2.0
Sep 2011	SP-53	SP-110634	0035	-	MDT for multiple PLMN IDs	F	10.2.0	11.0.0
Sep 2011	SP-53	SP-110538	0033	1	Adding requirements for MDT positioning	B	10.2.0	11.0.0
Sep 2011	SP-53	SP-110538	0037	2	Add MDT location correlation requirements	B	10.2.0	11.0.0
Dec 2011	SP-54	SP-110716	0048	2	Adding RLF specific use cases and requirements	B	11.0.0	11.1.0
Dec 2011	SP-54	SP-110715	0051	-	Support multiple cells in area based MDT	A	11.0.0	11.1.0
Dec 2011	SP-54	SP-110715	0039	2	Introduce the missing MDT data controller user privacy requirements	A	11.0.0	11.1.0
Dec 2011	SP-54	SP-110715	0046	1	Add MDT data deletion note	A	11.0.0	11.1.0
Dec 2011	SP-54	SP-110716	0044	1	Add MDT support requirements in RAN sharing scenario	B	11.0.0	11.1.0
Mar 2012	SP-55	SP-120054	0047	3	Add requirement on reduction of redundant MDT data	B	11.1.0	11.2.0
Mar 2012	SP-55	SP-120054	0054	1	Add MDT data collection criteria requirements	B	11.1.0	11.2.0
June-2012	SP-56	SP-120368	0058	1	Remove MDT Country Restriction	A	11.2.0	11.3.0
June-2012	SP-56	SP-120369	0059	1	Remove MDT Country Restriction	F	11.2.0	11.3.0
June-2012	SP-56	SP-120369	0060	--	Add MDT for Periodical sampling of network performance use case	B	11.2.0	11.3.0
Sep-2012	Sp-57	Sp-120571	0061	1	Clarify requirements on counting of distinct UEs	F	11.3.0	11.4.0
Dic 2012	SP-58	SP-120795	0064	1	Correction on the scope, references and abbreviations related to MDT and RLF	F	11.4.0	11.5.0
Dic 2012	SP-58	SP-120796	0065	1	Addition of Network Sharing	C	11.4.0	11.5.0
Mar 2013	SP-59	SP-130048	0066	1	Add IMEI-TAC usecase for UMTS and LTE area based MDT	F	11.5.0	11.6.0
Oct 2014	-	-	-	-	Update to Rel-12 version (MCC)		11.6.0	12.0.0
Dec 2014	SP-60	SP-140800	0073	1	Super CR for work item Network Sharing.	F	12.0.0	12.1.0
Jun 2015	SP-68	SP-150315	0074	2	Multi-Broadcast Single Frequency Network (MBSFN) Minimization of Drive Tests (MDT) enhancement.	B	12.1.0	13.0.0
2017-04	SA#75	-	-	-	Promotion to Release 14 without technical change		13.0.0	14.0.0

History

Document history		
V14.0.0	April 2017	Publication