

ETSI TS 136 211 V11.3.0 (2013-07)



Technical Specification

**LTE;
Evolved Universal Terrestrial Radio Access (E-UTRA);
Physical channels and modulation
(3GPP TS 36.211 version 11.3.0 Release 11)**



Reference

RTS/TSGR-0136211vb30

Keywords

LTE

ETSI

650 Route des Lucioles
F-06921 Sophia Antipolis Cedex - FRANCE

Tel.: +33 4 92 94 42 00 Fax: +33 4 93 65 47 16

Siret N° 348 623 562 00017 - NAF 742 C
Association à but non lucratif enregistrée à la
Sous-Préfecture de Grasse (06) N° 7803/88

Important notice

Individual copies of the present document can be downloaded from:

<http://www.etsi.org>

The present document may be made available in more than one electronic version or in print. In any case of existing or perceived difference in contents between such versions, the reference version is the Portable Document Format (PDF). In case of dispute, the reference shall be the printing on ETSI printers of the PDF version kept on a specific network drive within ETSI Secretariat.

Users of the present document should be aware that the document may be subject to revision or change of status. Information on the current status of this and other ETSI documents is available at

<http://portal.etsi.org/tb/status/status.asp>

If you find errors in the present document, please send your comment to one of the following services:

http://portal.etsi.org/chaicor/ETSI_support.asp

Copyright Notification

No part may be reproduced except as authorized by written permission.
The copyright and the foregoing restriction extend to reproduction in all media.

© European Telecommunications Standards Institute 2013.
All rights reserved.

DECT™, **PLUGTESTS™**, **UMTS™** and the ETSI logo are Trade Marks of ETSI registered for the benefit of its Members.
3GPP™ and **LTE™** are Trade Marks of ETSI registered for the benefit of its Members and
of the 3GPP Organizational Partners.
GSM® and the GSM logo are Trade Marks registered and owned by the GSM Association.

Intellectual Property Rights

IPRs essential or potentially essential to the present document may have been declared to ETSI. The information pertaining to these essential IPRs, if any, is publicly available for **ETSI members and non-members**, and can be found in ETSI SR 000 314: "*Intellectual Property Rights (IPRs); Essential, or potentially Essential, IPRs notified to ETSI in respect of ETSI standards*", which is available from the ETSI Secretariat. Latest updates are available on the ETSI Web server (<http://ipr.etsi.org>).

Pursuant to the ETSI IPR Policy, no investigation, including IPR searches, has been carried out by ETSI. No guarantee can be given as to the existence of other IPRs not referenced in ETSI SR 000 314 (or the updates on the ETSI Web server) which are, or may be, or may become, essential to the present document.

Foreword

This Technical Specification (TS) has been produced by ETSI 3rd Generation Partnership Project (3GPP).

The present document may refer to technical specifications or reports using their 3GPP identities, UMTS identities or GSM identities. These should be interpreted as being references to the corresponding ETSI deliverables.

The cross reference between GSM, UMTS, 3GPP and ETSI identities can be found under <http://webapp.etsi.org/key/queryform.asp>.

Contents

Intellectual Property Rights	2
Foreword.....	2
Foreword.....	6
1 Scope	7
2 References	7
3 Definitions, symbols and abbreviations	7
3.1 Symbols.....	7
3.2 Abbreviations	9
4 Frame structure.....	10
4.1 Frame structure type 1	10
4.2 Frame structure type 2	10
5 Uplink.....	12
5.1 Overview	12
5.1.1 Physical channels.....	12
5.1.2 Physical signals.....	12
5.2 Slot structure and physical resources.....	12
5.2.1 Resource grid	12
5.2.2 Resource elements	14
5.2.3 Resource blocks	14
5.3 Physical uplink shared channel	14
5.3.1 Scrambling	15
5.3.2 Modulation.....	15
5.3.2A Layer mapping	16
5.3.2A.1 Layer mapping for transmission on a single antenna port.....	16
5.3.2A.2 Layer mapping for spatial multiplexing	16
5.3.3 Transform precoding.....	16
5.3.3A Precoding	17
5.3.3A.1 Precoding for transmission on a single antenna port.....	17
5.3.3A.2 Precoding for spatial multiplexing	17
5.3.4 Mapping to physical resources.....	20
5.4 Physical uplink control channel.....	21
5.4.1 PUCCH formats 1, 1a and 1b	22
5.4.2 PUCCH formats 2, 2a and 2b	24
5.4.2A PUCCH format 3	25
5.4.3 Mapping to physical resources.....	26
5.5 Reference signals.....	27
5.5.1 Generation of the reference signal sequence.....	27
5.5.1.1 Base sequences of length $3N_{sc}^{RB}$ or larger	28
5.5.1.2 Base sequences of length less than $3N_{sc}^{RB}$	28
5.5.1.3 Group hopping	30
5.5.1.4 Sequence hopping	31
5.5.1.5 Determining virtual cell identity for sequence generation	31
5.5.2 Demodulation reference signal	32
5.5.2.1 Demodulation reference signal for PUSCH	32
5.5.2.1.1 Reference signal sequence.....	32
5.5.2.1.2 Mapping to physical resources	34
5.5.2.2 Demodulation reference signal for PUCCH.....	34
5.5.2.2.1 Reference signal sequence.....	34
5.5.2.2.2 Mapping to physical resources	35
5.5.3 Sounding reference signal.....	36
5.5.3.1 Sequence generation.....	36
5.5.3.2 Mapping to physical resources.....	36

5.5.3.3	Sounding reference signal subframe configuration	40
5.6	SC-FDMA baseband signal generation	40
5.7	Physical random access channel	41
5.7.1	Time and frequency structure	41
5.7.2	Preamble sequence generation	47
5.7.3	Baseband signal generation	50
5.8	Modulation and upconversion	50
6	Downlink	51
6.1	Overview	51
6.1.1	Physical channels	51
6.1.2	Physical signals	52
6.2	Slot structure and physical resource elements	52
6.2.1	Resource grid	52
6.2.2	Resource elements	52
6.2.3	Resource blocks	53
6.2.3.1	Virtual resource blocks of localized type	54
6.2.3.2	Virtual resource blocks of distributed type	54
6.2.4	Resource-element groups	55
6.2.4A	Enhanced resource-element groups	56
6.2.5	Guard period for half-duplex FDD operation	56
6.2.6	Guard Period for TDD Operation	56
6.3	General structure for downlink physical channels	56
6.3.1	Scrambling	57
6.3.2	Modulation	57
6.3.3	Layer mapping	57
6.3.3.1	Layer mapping for transmission on a single antenna port	58
6.3.3.2	Layer mapping for spatial multiplexing	58
6.3.3.3	Layer mapping for transmit diversity	60
6.3.4	Precoding	60
6.3.4.1	Precoding for transmission on a single antenna port	60
6.3.4.2	Precoding for spatial multiplexing using antenna ports with cell-specific reference signals	60
6.3.4.2.1	Precoding without CDD	60
6.3.4.2.2	Precoding for large delay CDD	61
6.3.4.2.3	Codebook for precoding and CSI reporting	62
6.3.4.3	Precoding for transmit diversity	63
6.3.4.4	Precoding for spatial multiplexing using antenna ports with UE-specific reference signals	64
6.3.5	Mapping to resource elements	64
6.4	Physical downlink shared channel	65
6.5	Physical multicast channel	65
6.6	Physical broadcast channel	66
6.6.1	Scrambling	66
6.6.2	Modulation	66
6.6.3	Layer mapping and precoding	66
6.6.4	Mapping to resource elements	66
6.7	Physical control format indicator channel	67
6.7.1	Scrambling	67
6.7.2	Modulation	67
6.7.3	Layer mapping and precoding	67
6.7.4	Mapping to resource elements	68
6.8	Physical downlink control channel	68
6.8.1	PDCCH formats	68
6.8.2	PDCCH multiplexing and scrambling	68
6.8.3	Modulation	69
6.8.4	Layer mapping and precoding	69
6.8.5	Mapping to resource elements	69
6.8A	Enhanced physical downlink control channel	70
6.8A.1	EPDCCH formats	70
6.8A.2	Scrambling	71
6.8A.3	Modulation	72
6.8A.4	Layer mapping and precoding	72
6.8A.5	Mapping to resource elements	72

6.9	Physical hybrid ARQ indicator channel	73
6.9.1	Modulation.....	73
6.9.2	Resource group alignment, layer mapping and precoding.....	74
6.9.3	Mapping to resource elements	76
6.10	Reference signals.....	77
6.10.1	Cell-specific reference signals	78
6.10.1.1	Sequence generation.....	78
6.10.1.2	Mapping to resource elements.....	78
6.10.2	MBSFN reference signals.....	80
6.10.2.1	Sequence generation.....	80
6.10.2.2	Mapping to resource elements.....	80
6.10.3	UE-specific reference signals associated with PDSCH	82
6.10.3.1	Sequence generation.....	82
6.10.3.2	Mapping to resource elements.....	83
6.10.3A	Demodulation reference signals associated with EPDCCH.....	88
6.10.3A.1	Sequence generation.....	88
6.10.3A.2	Mapping to resource elements.....	89
6.10.4	Positioning reference signals	90
6.10.4.1	Sequence generation.....	90
6.10.4.2	Mapping to resource elements.....	91
6.10.4.3	Positioning reference signal subframe configuration	92
6.10.5	CSI reference signals	92
6.10.5.1	Sequence generation.....	92
6.10.5.2	Mapping to resource elements.....	93
6.10.5.3	CSI reference signal subframe configuration	96
6.11	Synchronization signals.....	96
6.11.1	Primary synchronization signal.....	96
6.11.1.1	Sequence generation.....	96
6.11.1.2	Mapping to resource elements.....	97
6.11.2	Secondary synchronization signal.....	97
6.11.2.1	Sequence generation.....	97
6.11.2.2	Mapping to resource elements.....	99
6.12	OFDM baseband signal generation	100
6.13	Modulation and upconversion	100
7	Generic functions	101
7.1	Modulation mapper	101
7.1.1	BPSK.....	101
7.1.2	QPSK.....	101
7.1.3	16QAM	102
7.1.4	64QAM	102
7.2	Pseudo-random sequence generation.....	103
8	Timing	104
8.1	Uplink-downlink frame timing.....	104
Annex A (informative): Change history		105
History		109

Foreword

This Technical Specification has been produced by the 3rd Generation Partnership Project (3GPP).

The contents of the present document are subject to continuing work within the TSG and may change following formal TSG approval. Should the TSG modify the contents of the present document, it will be re-released by the TSG with an identifying change of release date and an increase in version number as follows:

Version x.y.z

where:

- x the first digit:
 - 1 presented to TSG for information;
 - 2 presented to TSG for approval;
 - 3 or greater indicates TSG approved document under change control.
- y the second digit is incremented for all changes of substance, i.e. technical enhancements, corrections, updates, etc.
- z the third digit is incremented when editorial only changes have been incorporated in the document.

1 Scope

The present document describes the physical channels for evolved UTRA.

2 References

The following documents contain provisions which, through reference in this text, constitute provisions of the present document.

- References are either specific (identified by date of publication, edition number, version number, etc.) or non-specific.
- For a specific reference, subsequent revisions do not apply.
- For a non-specific reference, the latest version applies. In the case of a reference to a 3GPP document (including a GSM document), a non-specific reference implicitly refers to the latest version of that document *in the same Release as the present document*.

- [1] 3GPP TR 21.905: "Vocabulary for 3GPP Specifications".
 - [2] 3GPP TS 36.201: "Evolved Universal Terrestrial Radio Access (E-UTRA); Physical Layer – General Description".
 - [3] 3GPP TS 36.212: "Evolved Universal Terrestrial Radio Access (E-UTRA); Multiplexing and channel coding".
 - [4] 3GPP TS 36.213: "Evolved Universal Terrestrial Radio Access (E-UTRA); Physical layer procedures".
 - [5] 3GPP TS 36.214: "Evolved Universal Terrestrial Radio Access (E-UTRA); Physical layer – Measurements".
 - [6] 3GPP TS 36.104: 'Evolved Universal Terrestrial Radio Access (E-UTRA); Base Station (BS) radio transmission and reception'.
 - [7] 3GPP TS 36.101: 'Evolved Universal Terrestrial Radio Access (E-UTRA); User Equipment (UE) radio transmission and reception'.
 - [8] 3GPP TS36.321, 'Evolved Universal Terrestrial Radio Access (E-UTRA); Medium Access Control (MAC) protocol specification'
-

3 Definitions, symbols and abbreviations

3.1 Symbols

For the purposes of the present document, the following symbols apply:

(k, l)	Resource element with frequency-domain index k and time-domain index l
$a_{k,l}^{(p)}$	Value of resource element (k, l) [for antenna port p]
D	Matrix for supporting cyclic delay diversity
D_{RA}	Density of random access opportunities per radio frame
f_0	Carrier frequency

f_{RA}	PRACH resource frequency index within the considered time-domain location
M_{sc}^{PUSCH}	Scheduled bandwidth for uplink transmission, expressed as a number of subcarriers
M_{RB}^{PUSCH}	Scheduled bandwidth for uplink transmission, expressed as a number of resource blocks
$M_{bit}^{(q)}$	Number of coded bits to transmit on a physical channel [for codeword q]
$M_{symb}^{(q)}$	Number of modulation symbols to transmit on a physical channel [for codeword q]
M_{symb}^{layer}	Number of modulation symbols to transmit per layer for a physical channel
M_{symb}^{ap}	Number of modulation symbols to transmit per antenna port for a physical channel
N	A constant equal to 2048 for $\Delta f = 15$ kHz and 4096 for $\Delta f = 7.5$ kHz
$N_{CP,l}$	Downlink cyclic prefix length for OFDM symbol l in a slot
N_{CS}	Cyclic shift value used for random access preamble generation
$N_{cs}^{(1)}$	Number of cyclic shifts used for PUCCH formats 1/1a/1b in a resource block with a mix of formats 1/1a/1b and 2/2a/2b
$N_{RB}^{(2)}$	Bandwidth available for use by PUCCH formats 2/2a/2b, expressed in multiples of N_{sc}^{RB}
N_{RB}^{HO}	The offset used for PUSCH frequency hopping, expressed in number of resource blocks (set by higher layers)
N_{ID}^{cell}	Physical layer cell identity
N_{ID}^{MBSFN}	MBSFN area identity
N_{RB}^{DL}	Downlink bandwidth configuration, expressed in multiples of N_{sc}^{RB}
$N_{RB}^{min, DL}$	Smallest downlink bandwidth configuration, expressed in multiples of N_{sc}^{RB}
$N_{RB}^{max, DL}$	Largest downlink bandwidth configuration, expressed in multiples of N_{sc}^{RB}
N_{RB}^{UL}	Uplink bandwidth configuration, expressed in multiples of N_{sc}^{RB}
$N_{RB}^{min, UL}$	Smallest uplink bandwidth configuration, expressed in multiples of N_{sc}^{RB}
$N_{RB}^{max, UL}$	Largest uplink bandwidth configuration, expressed in multiples of N_{sc}^{RB}
N_{symb}^{DL}	Number of OFDM symbols in a downlink slot
N_{symb}^{UL}	Number of SC-FDMA symbols in an uplink slot
N_{sc}^{RB}	Resource block size in the frequency domain, expressed as a number of subcarriers
N_{sb}	Number of sub-bands for PUSCH frequency-hopping with predefined hopping pattern
N_{RB}^{sb}	Size of each sub-band for PUSCH frequency-hopping with predefined hopping pattern, expressed as a number of resource blocks
N_{SP}	Number of downlink to uplink switch points within the radio frame
N_{RS}^{PUCCH}	Number of reference symbols per slot for PUCCH
N_{TA}	Timing offset between uplink and downlink radio frames at the UE, expressed in units of T_s
N_{TA}^{offset}	Fixed timing advance offset, expressed in units of T_s
$n_{PUCCH}^{(1,\bar{p})}$	Resource index for PUCCH formats 1/1a/1b
$n_{PUCCH}^{(2,\bar{p})}$	Resource index for PUCCH formats 2/2a/2b
$n_{PUCCH}^{(3,\bar{p})}$	Resource index for PUCCH formats 3
n_{PDCCH}	Number of PDCCHs present in a subframe
n_{PRB}	Physical resource block number
n_{PRB}^{RA}	First physical resource block occupied by PRACH resource considered
$n_{PRB}^{RA, offset}$	First physical resource block available for PRACH
n_{VRB}	Virtual resource block number
n_{RNTI}	Radio network temporary identifier
n_f	System frame number

n_s	Slot number within a radio frame
P	Number of antenna ports used for transmission of a channel
p	Antenna port number
q	Codeword number
r_{RA}	Index for PRACH versions with same preamble format and PRACH density
Q_m	Modulation order: 2 for QPSK, 4 for 16QAM and 6 for 64QAM transmissions
$s_l^{(p)}(t)$	Time-continuous baseband signal for antenna port p and OFDM symbol l in a slot
$t_{\text{RA}}^{(0)}$	Radio frame indicator index of PRACH opportunity
$t_{\text{RA}}^{(1)}$	Half frame index of PRACH opportunity within the radio frame
$t_{\text{RA}}^{(2)}$	Uplink subframe number for start of PRACH opportunity within the half frame
T_f	Radio frame duration
T_s	Basic time unit
T_{slot}	Slot duration
W	Precoding matrix for downlink spatial multiplexing
β_{PRACH}	Amplitude scaling for PRACH
β_{PUCCH}	Amplitude scaling for PUCCH
β_{PUSCH}	Amplitude scaling for PUSCH
β_{SRS}	Amplitude scaling for sounding reference symbols
Δf	Subcarrier spacing
Δf_{RA}	Subcarrier spacing for the random access preamble
v	Number of transmission layers

3.2 Abbreviations

For the purposes of the present document, the following abbreviations apply:

CCE	Control channel element
CDD	Cyclic delay diversity
CRS	Cell-specific reference signal
CSI	Channel-State Information
DCI	Downlink control information
DM-RS	Demodulation reference signal
ECCE	Enhanced control channel element
EPDCCH	Enhanced physical downlink control channel
EREG	Enhanced resource-element group
PBCH	Physical broadcast channel
PCFICH	Physical control format indicator channel
PDCCH	Physical downlink control channel
PDSCH	Physical downlink shared channel
PHICH	Physical hybrid-ARQ indicator channel
PMCH	Physical multicast channel
PRACH	Physical random access channel
PRB	Physical resource block
PRS	Positioning reference signal
PUCCH	Physical uplink control channel
PUSCH	Physical uplink shared channel
REG	Resource-element group
SRS	Sounding Reference Signal
VRB	Virtual resource block

4 Frame structure

Throughout this specification, unless otherwise noted, the size of various fields in the time domain is expressed as a number of time units $T_s = 1/(15000 \times 2048)$ seconds.

Downlink and uplink transmissions are organized into radio frames with $T_f = 307200 \times T_s = 10$ ms duration. Two radio frame structures are supported:

- Type 1, applicable to FDD,
- Type 2, applicable to TDD.

Transmissions in multiple cells can be aggregated where up to four secondary cells can be used in addition to the primary cell. Unless otherwise noted, the description in this specification applies to each of the up to five serving cells. In case of multi-cell aggregation, the UE may assume the same frame structure is used in all the serving cells.

4.1 Frame structure type 1

Frame structure type 1 is applicable to both full duplex and half duplex FDD. Each radio frame is $T_f = 307200 \cdot T_s = 10$ ms long and consists of 20 slots of length $T_{\text{slot}} = 15360 \cdot T_s = 0.5$ ms, numbered from 0 to 19. A subframe is defined as two consecutive slots where subframe i consists of slots $2i$ and $2i+1$.

For FDD, 10 subframes are available for downlink transmission and 10 subframes are available for uplink transmissions in each 10 ms interval. Uplink and downlink transmissions are separated in the frequency domain. In half-duplex FDD operation, the UE cannot transmit and receive at the same time while there are no such restrictions in full-duplex FDD.

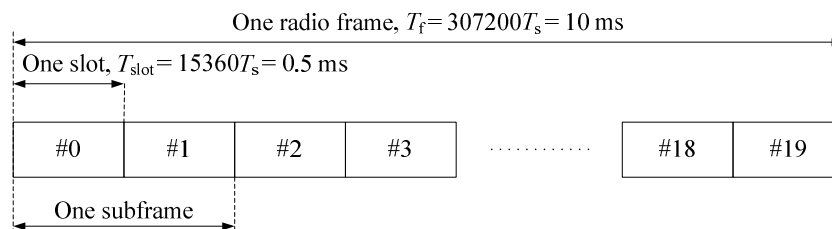

Figure 4.1-1: Frame structure type 1.

4.2 Frame structure type 2

Frame structure type 2 is applicable to TDD. Each radio frame of length $T_f = 307200 \cdot T_s = 10$ ms consists of two half-frames of length $153600 \cdot T_s = 5$ ms each. Each half-frame consists of five subframes of length $30720 \cdot T_s = 1$ ms. The supported uplink-downlink configurations are listed in Table 4.2-2 where, for each subframe in a radio frame, 'D' denotes the subframe is reserved for downlink transmissions, 'U' denotes the subframe is reserved for uplink transmissions and 'S' denotes a special subframe with the three fields DwPTS, GP and UpPTS. The length of DwPTS and UpPTS is given by Table 4.2-1 subject to the total length of DwPTS, GP and UpPTS being equal to $30720 \cdot T_s = 1$ ms. Each subframe i is defined as two slots, $2i$ and $2i+1$ of length $T_{\text{slot}} = 15360 \cdot T_s = 0.5$ ms in each subframe.

Uplink-downlink configurations with both 5 ms and 10 ms downlink-to-uplink switch-point periodicity are supported.

In case of 5 ms downlink-to-uplink switch-point periodicity, the special subframe exists in both half-frames.

In case of 10 ms downlink-to-uplink switch-point periodicity, the special subframe exists in the first half-frame only.

Subframes 0 and 5 and DwPTS are always reserved for downlink transmission. UpPTS and the subframe immediately following the special subframe are always reserved for uplink transmission.

In case multiple cells are aggregated, the UE may assume that the guard period of the special subframe in the different cells have an overlap of at least $1456 \cdot T_s$.

In case multiple cells with different uplink-downlink configurations are aggregated and the UE is not capable of simultaneous reception and transmission in the aggregated cells, the following constraints apply:

- if the subframe in the primary cell is a downlink subframe, the UE shall not transmit any signal or channel on a secondary cell in the same subframe
- if the subframe in the primary cell is an uplink subframe, the UE is not expected to receive any downlink transmissions on a secondary cell in the same subframe
- if the subframe in the primary cell is a special subframe and the same subframe in a secondary cell is a downlink subframe, the UE is not expected to receive PDSCH/EPDCCH/PMCH/PRS transmissions in the secondary cell in the same subframe, and the UE is not expected to receive any other signals on the secondary cell in OFDM symbols that overlaps with the guard period or UpPTS in the primary cell.

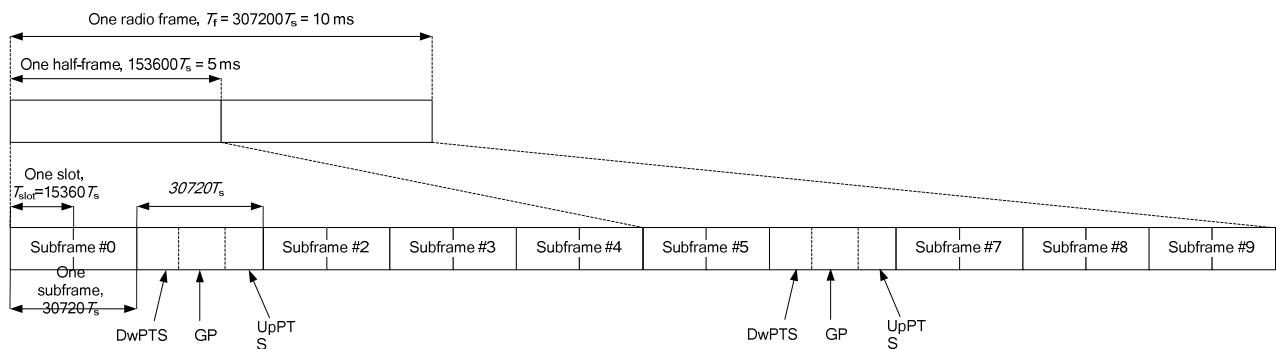

Figure 4.2-1: Frame structure type 2 (for 5 ms switch-point periodicity).

Table 4.2-1: Configuration of special subframe (lengths of DwPTS/GP/UpPTS).

Special subframe configuration	Normal cyclic prefix in downlink			Extended cyclic prefix in downlink		
	DwPTS	UpPTS		DwPTS	UpPTS	
		Normal cyclic prefix in uplink	Extended cyclic prefix in uplink		Normal cyclic prefix in uplink	Extended cyclic prefix in uplink
0	$6592 \cdot T_s$	$2192 \cdot T_s$	$2560 \cdot T_s$	$7680 \cdot T_s$	$2192 \cdot T_s$	$2560 \cdot T_s$
1	$19760 \cdot T_s$			$20480 \cdot T_s$		
2	$21952 \cdot T_s$			$23040 \cdot T_s$		
3	$24144 \cdot T_s$			$25600 \cdot T_s$		
4	$26336 \cdot T_s$			$7680 \cdot T_s$		
5	$6592 \cdot T_s$	$4384 \cdot T_s$	$5120 \cdot T_s$	$20480 \cdot T_s$	$4384 \cdot T_s$	$5120 \cdot T_s$
6	$19760 \cdot T_s$			$23040 \cdot T_s$		
7	$21952 \cdot T_s$			$12800 \cdot T_s$		
8	$24144 \cdot T_s$			-		
9	$13168 \cdot T_s$			-		

Table 4.2-2: Uplink-downlink configurations.

Uplink-downlink configuration	Downlink-to-Uplink Switch-point periodicity	Subframe number									
		0	1	2	3	4	5	6	7	8	9
0	5 ms	D	S	U	U	U	D	S	U	U	U
1	5 ms	D	S	U	U	D	D	S	U	U	D
2	5 ms	D	S	U	D	D	D	S	U	D	D
3	10 ms	D	S	U	U	U	D	D	D	D	D
4	10 ms	D	S	U	U	D	D	D	D	D	D
5	10 ms	D	S	U	D	D	D	D	D	D	D
6	5 ms	D	S	U	U	U	D	S	U	U	D

5 Uplink

5.1 Overview

The smallest resource unit for uplink transmissions is denoted a resource element and is defined in section 5.2.2.

5.1.1 Physical channels

An uplink physical channel corresponds to a set of resource elements carrying information originating from higher layers and is the interface defined between 36.212 and 36.211. The following uplink physical channels are defined:

- Physical Uplink Shared Channel, PUSCH
- Physical Uplink Control Channel, PUCCH
- Physical Random Access Channel, PRACH

5.1.2 Physical signals

An uplink physical signal is used by the physical layer but does not carry information originating from higher layers. The following uplink physical signals are defined:

- Reference signal

5.2 Slot structure and physical resources

5.2.1 Resource grid

The transmitted signal in each slot is described by one or several resource grids of $N_{RB}^{UL} N_{sc}^{RB}$ subcarriers and N_{symb}^{UL} SC-FDMA symbols. The resource grid is illustrated in Figure 5.2.1-1. The quantity N_{RB}^{UL} depends on the uplink transmission bandwidth configured in the cell and shall fulfil

$$N_{RB}^{\min, UL} \leq N_{RB}^{UL} \leq N_{RB}^{\max, UL}$$

where $N_{RB}^{\min, UL} = 6$ and $N_{RB}^{\max, UL} = 110$ are the smallest and largest uplink bandwidths, respectively, supported by the current version of this specification. The set of allowed values for N_{RB}^{UL} is given by [7].

The number of SC-FDMA symbols in a slot depends on the cyclic prefix length configured by the higher layer parameter *UL-CyclicPrefixLength* and is given in Table 5.2.3-1.

An antenna port is defined such that the channel over which a symbol on the antenna port is conveyed can be inferred from the channel over which another symbol on the same antenna port is conveyed. There is one resource grid per antenna port. The antenna ports used for transmission of a physical channel or signal depends on the number of antenna

ports configured for the physical channel or signal as shown in Table 5.2.1-1. The index \tilde{p} is used throughout Section 5 when a sequential numbering of the antenna ports is necessary.

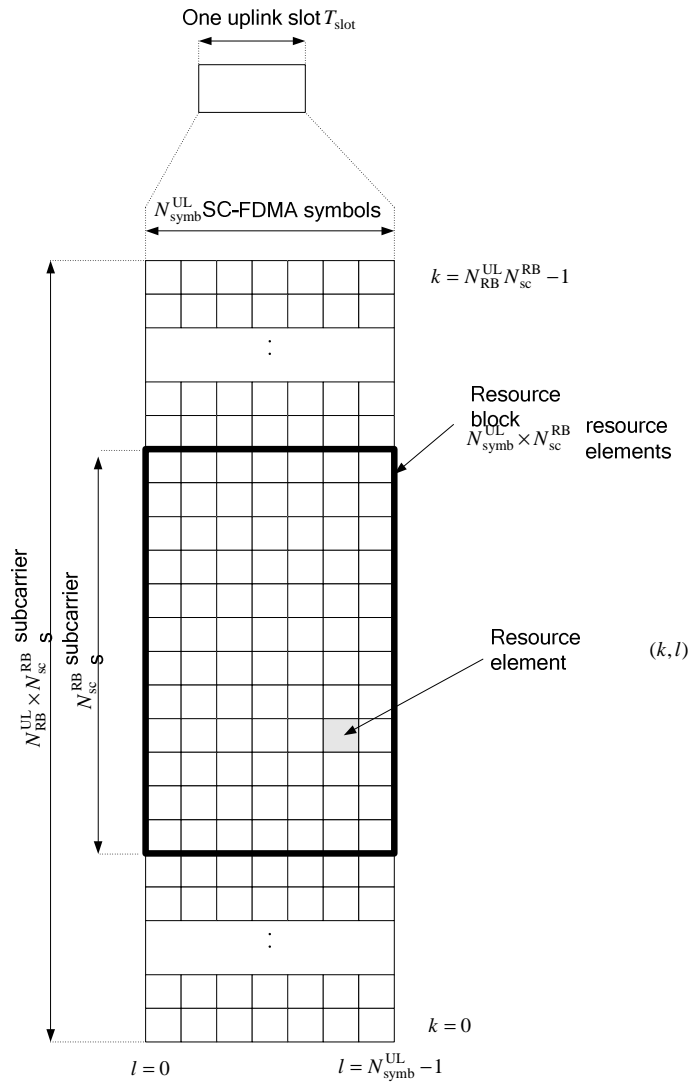

Figure 5.2.1-1: Uplink resource grid.

Table 5.2.1-1: The antenna ports used for different physical channels and signals.

Physical channel or signal	Index \tilde{p}	Antenna port number p as a function of the number of antenna ports configured for the respective physical channel/signal		
		1	2	4
PUSCH	0	10	20	40
	1	-	21	41
	2	-	-	42
	3	-	-	43
SRS	0	10	20	40
	1	-	21	41
	2	-	-	42
	3	-	-	43
PUCCH	0	100	200	-
	1	-	201	-

5.2.2 Resource elements

Each element in the resource grid is called a resource element and is uniquely defined by the index pair (k, l) in a slot where $k = 0, \dots, N_{RB}^{UL} N_{sc}^{RB} - 1$ and $l = 0, \dots, N_{symb}^{UL} - 1$ are the indices in the frequency and time domains, respectively. Resource element (k, l) on antenna port p corresponds to the complex value $a_{k,l}^{(p)}$. When there is no risk for confusion, or no particular antenna port is specified, the index p may be dropped. Quantities $a_{k,l}^{(p)}$ corresponding to resource elements not used for transmission of a physical channel or a physical signal in a slot shall be set to zero.

5.2.3 Resource blocks

A physical resource block is defined as N_{symb}^{UL} consecutive SC-FDMA symbols in the time domain and N_{sc}^{RB} consecutive subcarriers in the frequency domain, where N_{symb}^{UL} and N_{sc}^{RB} are given by Table 5.2.3-1. A physical resource block in the uplink thus consists of $N_{symb}^{UL} \times N_{sc}^{RB}$ resource elements, corresponding to one slot in the time domain and 180 kHz in the frequency domain.

Table 5.2.3-1: Resource block parameters.

Configuration	N_{sc}^{RB}	N_{symb}^{UL}
Normal cyclic prefix	12	7
Extended cyclic prefix	12	6

The relation between the physical resource block number n_{PRB} in the frequency domain and resource elements (k, l) in a slot is given by

$$n_{PRB} = \left\lfloor \frac{k}{N_{sc}^{RB}} \right\rfloor$$

5.3 Physical uplink shared channel

The baseband signal representing the physical uplink shared channel is defined in terms of the following steps:

- scrambling
- modulation of scrambled bits to generate complex-valued symbols
- mapping of the complex-valued modulation symbols onto one or several transmission layers
- transform precoding to generate complex-valued symbols
- precoding of the complex-valued symbols
- mapping of precoded complex-valued symbols to resource elements
- generation of complex-valued time-domain SC-FDMA signal for each antenna port

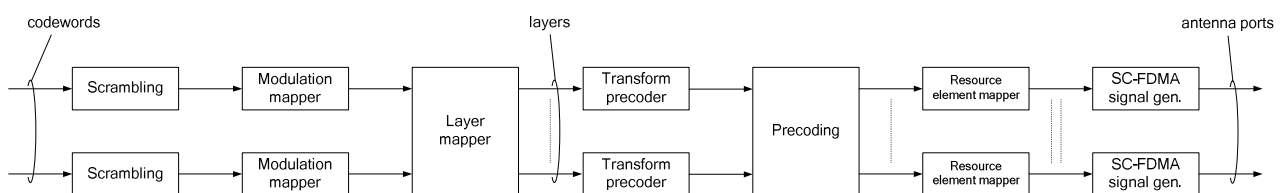

Figure 5.3-1: Overview of uplink physical channel processing.

5.3.1 Scrambling

For each codeword q , the block of bits $b^{(q)}(0), \dots, b^{(q)}(M_{\text{bit}}^{(q)} - 1)$, where $M_{\text{bit}}^{(q)}$ is the number of bits transmitted in codeword q on the physical uplink shared channel in one subframe, shall be scrambled with a UE-specific scrambling sequence prior to modulation, resulting in a block of scrambled bits $\tilde{b}^{(q)}(0), \dots, \tilde{b}^{(q)}(M_{\text{bit}}^{(q)} - 1)$ according to the following pseudo code

Set $i = 0$

while $i < M_{\text{bit}}^{(q)}$

if $b^{(q)}(i) = x$ // ACK/NACK or Rank Indication placeholder bits

$\tilde{b}^{(q)}(i) = 1$

else

if $b^{(q)}(i) = y$ // ACK/NACK or Rank Indication repetition placeholder bits

$\tilde{b}^{(q)}(i) = \tilde{b}^{(q)}(i-1)$

else // Data or channel quality coded bits, Rank Indication coded bits or ACK/NACK coded bits

$\tilde{b}^{(q)}(i) = (b^{(q)}(i) + c^{(q)}(i)) \bmod 2$

end if

end if

$i = i + 1$

end while

where x and y are tags defined in [3] section 5.2.2.6 and where the scrambling sequence $c^{(q)}(i)$ is given by Section 7.2. The scrambling sequence generator shall be initialised with $c_{\text{init}} = n_{\text{RNTI}} \cdot 2^{14} + q \cdot 2^{13} + \lfloor n_s/2 \rfloor \cdot 2^9 + N_{\text{ID}}^{\text{cell}}$ at the start of each subframe where n_{RNTI} corresponds to the RNTI associated with the PUSCH transmission as described in Section 8 in [4].

Up to two codewords can be transmitted in one subframe, i.e., $q \in \{0,1\}$. In the case of single-codeword transmission, $q = 0$.

5.3.2 Modulation

For each codeword q , the block of scrambled bits $\tilde{b}^{(q)}(0), \dots, \tilde{b}^{(q)}(M_{\text{bit}}^{(q)} - 1)$ shall be modulated as described in Section 7.1, resulting in a block of complex-valued symbols $d^{(q)}(0), \dots, d^{(q)}(M_{\text{ymb}}^{(q)} - 1)$. Table 5.3.2-1 specifies the modulation mappings applicable for the physical uplink shared channel.

Table 5.3.2-1: Uplink modulation schemes.

Physical channel	Modulation schemes
PUSCH	QPSK, 16QAM, 64QAM

5.3.2A Layer mapping

The complex-valued modulation symbols for each of the codewords to be transmitted are mapped onto one or two layers. Complex-valued modulation symbols $d^{(q)}(0), \dots, d^{(q)}(M_{\text{symb}}^{(q)} - 1)$ for codeword q shall be mapped onto the layers $x(i) = [x^{(0)}(i) \ \dots \ x^{(v-1)}(i)]^T$, $i = 0, 1, \dots, M_{\text{symb}}^{\text{layer}} - 1$ where v is the number of layers and $M_{\text{symb}}^{\text{layer}}$ is the number of modulation symbols per layer.

5.3.2A.1 Layer mapping for transmission on a single antenna port

For transmission on a single antenna port, a single layer is used, $v = 1$, and the mapping is defined by

$$x^{(0)}(i) = d^{(0)}(i)$$

with $M_{\text{symb}}^{\text{layer}} = M_{\text{symb}}^{(0)}$.

5.3.2A.2 Layer mapping for spatial multiplexing

For spatial multiplexing, the layer mapping shall be done according to Table 5.3.2A.2-1. The number of layers v is less than or equal to the number of antenna ports P used for transmission of the physical uplink shared channel. The case of a single codeword mapped to multiple layers is only applicable when the number of antenna ports used for PUSCH is four.

Table 5.3.2A.2-1: Codeword-to-layer mapping for spatial multiplexing.

Number of layers	Number of codewords	Codeword-to-layer mapping $i = 0, 1, \dots, M_{\text{symb}}^{\text{layer}} - 1$
1	1	$x^{(0)}(i) = d^{(0)}(i)$ $M_{\text{symb}}^{\text{layer}} = M_{\text{symb}}^{(0)}$
2	1	$x^{(0)}(i) = d^{(0)}(2i)$ $x^{(1)}(i) = d^{(0)}(2i + 1)$ $M_{\text{symb}}^{\text{layer}} = M_{\text{symb}}^{(0)} / 2$
2	2	$x^{(0)}(i) = d^{(0)}(i)$ $x^{(1)}(i) = d^{(1)}(i)$ $M_{\text{symb}}^{\text{layer}} = M_{\text{symb}}^{(0)} = M_{\text{symb}}^{(1)}$
3	2	$x^{(0)}(i) = d^{(0)}(i)$ $x^{(1)}(i) = d^{(1)}(2i)$ $x^{(2)}(i) = d^{(1)}(2i + 1)$ $M_{\text{symb}}^{\text{layer}} = M_{\text{symb}}^{(0)} = M_{\text{symb}}^{(1)} / 2$
4	2	$x^{(0)}(i) = d^{(0)}(2i)$ $x^{(1)}(i) = d^{(0)}(2i + 1)$ $x^{(2)}(i) = d^{(1)}(2i)$ $x^{(3)}(i) = d^{(1)}(2i + 1)$ $M_{\text{symb}}^{\text{layer}} = M_{\text{symb}}^{(0)} / 2 = M_{\text{symb}}^{(1)} / 2$

5.3.3 Transform precoding

For each layer $\lambda = 0, 1, \dots, v - 1$ the block of complex-valued symbols $x^{(\lambda)}(0), \dots, x^{(\lambda)}(M_{\text{symb}}^{\text{layer}} - 1)$ is divided into

$M_{\text{symb}}^{\text{layer}} / M_{\text{sc}}^{\text{PUSCH}}$ sets, each corresponding to one SC-FDMA symbol. Transform precoding shall be applied according to

$$y^{(\lambda)}(l \cdot M_{\text{sc}}^{\text{PUSCH}} + k) = \frac{1}{\sqrt{M_{\text{sc}}^{\text{PUSCH}}}} \sum_{i=0}^{M_{\text{sc}}^{\text{PUSCH}}-1} x^{(\lambda)}(l \cdot M_{\text{sc}}^{\text{PUSCH}} + i) e^{-j \frac{2\pi i k}{M_{\text{sc}}^{\text{PUSCH}}}}$$

$$k = 0, \dots, M_{\text{sc}}^{\text{PUSCH}} - 1$$

$$l = 0, \dots, M_{\text{symb}}^{\text{layer}} / M_{\text{sc}}^{\text{PUSCH}} - 1$$

resulting in a block of complex-valued symbols $y^{(\lambda)}(0), \dots, y^{(\lambda)}(M_{\text{symb}}^{\text{layer}} - 1)$. The variable $M_{\text{sc}}^{\text{PUSCH}} = M_{\text{RB}}^{\text{PUSCH}} \cdot N_{\text{sc}}^{\text{RB}}$, where $M_{\text{RB}}^{\text{PUSCH}}$ represents the bandwidth of the PUSCH in terms of resource blocks, and shall fulfil

$$M_{\text{RB}}^{\text{PUSCH}} = 2^{\alpha_2} \cdot 3^{\alpha_3} \cdot 5^{\alpha_5} \leq N_{\text{RB}}^{\text{UL}}$$

where $\alpha_2, \alpha_3, \alpha_5$ is a set of non-negative integers.

5.3.3A Precoding

The precoder takes as input a block of vectors $[y^{(0)}(i) \ \dots \ y^{(v-1)}(i)]^T$, $i = 0, 1, \dots, M_{\text{symb}}^{\text{layer}} - 1$ from the transform precoder and generates a block of vectors $[z^{(0)}(i) \ \dots \ z^{(P-1)}(i)]^T$, $i = 0, 1, \dots, M_{\text{symb}}^{\text{ap}} - 1$ to be mapped onto resource elements.

5.3.3A.1 Precoding for transmission on a single antenna port

For transmission on a single antenna port, precoding is defined by

$$z^{(0)}(i) = y^{(0)}(i)$$

where $i = 0, 1, \dots, M_{\text{symb}}^{\text{ap}} - 1$, $M_{\text{symb}}^{\text{ap}} = M_{\text{symb}}^{\text{layer}}$.

5.3.3A.2 Precoding for spatial multiplexing

Precoding for spatial multiplexing is only used in combination with layer mapping for spatial multiplexing as described in Section 5.3.2A.2. Spatial multiplexing supports $P = 2$ or $P = 4$ antenna ports where the set of antenna ports used for spatial multiplexing is $p \in \{20, 21\}$ and $p \in \{40, 41, 42, 43\}$, respectively.

Precoding for spatial multiplexing is defined by

$$\begin{bmatrix} z^{(0)}(i) \\ \vdots \\ z^{(P-1)}(i) \end{bmatrix} = W \begin{bmatrix} y^{(0)}(i) \\ \vdots \\ y^{(v-1)}(i) \end{bmatrix}$$

where $i = 0, 1, \dots, M_{\text{symb}}^{\text{ap}} - 1$, $M_{\text{symb}}^{\text{ap}} = M_{\text{symb}}^{\text{layer}}$.

The precoding matrix W of size $P \times v$ is given by one of the entries in Table 5.3.3A.2-1 for $P = 2$ and by Tables 5.3.3A.2-2 through 5.3.3A.2-5 for $P = 4$ where the entries in each row are ordered from left to right in increasing order of codebook indices.

Table 5.3.3A.2-1: Codebook for transmission on antenna ports $\{20, 21\}$.

Codebook index	Number of layers	
	$v = 1$	$v = 2$

0	$\frac{1}{\sqrt{2}} \begin{bmatrix} 1 \\ 1 \end{bmatrix}$	$\frac{1}{\sqrt{2}} \begin{bmatrix} 1 & 0 \\ 0 & 1 \end{bmatrix}$
1	$\frac{1}{\sqrt{2}} \begin{bmatrix} 1 \\ -1 \end{bmatrix}$	-
2	$\frac{1}{\sqrt{2}} \begin{bmatrix} 1 \\ j \end{bmatrix}$	-
3	$\frac{1}{\sqrt{2}} \begin{bmatrix} 1 \\ -j \end{bmatrix}$	-
4	$\frac{1}{\sqrt{2}} \begin{bmatrix} 1 \\ 0 \end{bmatrix}$	-
5	$\frac{1}{\sqrt{2}} \begin{bmatrix} 0 \\ 1 \end{bmatrix}$	-

Table 5.3.3A.2-2: Codebook for transmission on antenna ports {40,41,42,43} with $v=1$.

Codebook index	Number of layers $v=1$							
0-7	$\frac{1}{2} \begin{bmatrix} 1 \\ 1 \\ 1 \\ -1 \end{bmatrix}$	$\frac{1}{2} \begin{bmatrix} 1 \\ 1 \\ j \\ j \end{bmatrix}$	$\frac{1}{2} \begin{bmatrix} 1 \\ 1 \\ -1 \\ 1 \end{bmatrix}$	$\frac{1}{2} \begin{bmatrix} 1 \\ 1 \\ -j \\ -j \end{bmatrix}$	$\frac{1}{2} \begin{bmatrix} 1 \\ j \\ 1 \\ j \end{bmatrix}$	$\frac{1}{2} \begin{bmatrix} 1 \\ j \\ j \\ 1 \end{bmatrix}$	$\frac{1}{2} \begin{bmatrix} 1 \\ j \\ -1 \\ -j \end{bmatrix}$	$\frac{1}{2} \begin{bmatrix} 1 \\ j \\ -j \\ -1 \end{bmatrix}$
8-15	$\frac{1}{2} \begin{bmatrix} 1 \\ -1 \\ 1 \\ 1 \end{bmatrix}$	$\frac{1}{2} \begin{bmatrix} 1 \\ -1 \\ j \\ -j \end{bmatrix}$	$\frac{1}{2} \begin{bmatrix} 1 \\ -1 \\ -1 \\ -1 \end{bmatrix}$	$\frac{1}{2} \begin{bmatrix} 1 \\ -1 \\ -j \\ j \end{bmatrix}$	$\frac{1}{2} \begin{bmatrix} 1 \\ -j \\ 1 \\ -j \end{bmatrix}$	$\frac{1}{2} \begin{bmatrix} 1 \\ -j \\ j \\ -1 \end{bmatrix}$	$\frac{1}{2} \begin{bmatrix} 1 \\ -j \\ -1 \\ j \end{bmatrix}$	$\frac{1}{2} \begin{bmatrix} 1 \\ -j \\ -j \\ 1 \end{bmatrix}$
16-23	$\frac{1}{2} \begin{bmatrix} 1 \\ 0 \\ 1 \\ 0 \end{bmatrix}$	$\frac{1}{2} \begin{bmatrix} 1 \\ 0 \\ -1 \\ 0 \end{bmatrix}$	$\frac{1}{2} \begin{bmatrix} 1 \\ 0 \\ j \\ 0 \end{bmatrix}$	$\frac{1}{2} \begin{bmatrix} 1 \\ 0 \\ -j \\ 0 \end{bmatrix}$	$\frac{1}{2} \begin{bmatrix} 0 \\ 1 \\ 0 \\ 1 \end{bmatrix}$	$\frac{1}{2} \begin{bmatrix} 0 \\ 1 \\ 0 \\ -1 \end{bmatrix}$	$\frac{1}{2} \begin{bmatrix} 0 \\ 1 \\ 0 \\ j \end{bmatrix}$	$\frac{1}{2} \begin{bmatrix} 0 \\ 1 \\ 0 \\ -j \end{bmatrix}$

Table 5.3.3A.2-3: Codebook for transmission on antenna ports {40,41,42,43} with $v = 2$.

Codebook index	Number of layers $v = 2$			
0-3	$\frac{1}{2} \begin{bmatrix} 1 & 0 \\ 1 & 0 \\ 0 & 1 \\ 0 & -j \end{bmatrix}$	$\frac{1}{2} \begin{bmatrix} 1 & 0 \\ 1 & 0 \\ 0 & 1 \\ 0 & j \end{bmatrix}$	$\frac{1}{2} \begin{bmatrix} 1 & 0 \\ -j & 0 \\ 0 & 1 \\ 0 & 1 \end{bmatrix}$	$\frac{1}{2} \begin{bmatrix} 1 & 0 \\ -j & 0 \\ 0 & 1 \\ 0 & -1 \end{bmatrix}$
4-7	$\frac{1}{2} \begin{bmatrix} 1 & 0 \\ -1 & 0 \\ 0 & 1 \\ 0 & -j \end{bmatrix}$	$\frac{1}{2} \begin{bmatrix} 1 & 0 \\ -1 & 0 \\ 0 & 1 \\ 0 & j \end{bmatrix}$	$\frac{1}{2} \begin{bmatrix} 1 & 0 \\ j & 0 \\ 0 & 1 \\ 0 & 1 \end{bmatrix}$	$\frac{1}{2} \begin{bmatrix} 1 & 0 \\ j & 0 \\ 0 & 1 \\ 0 & -1 \end{bmatrix}$
8-11	$\frac{1}{2} \begin{bmatrix} 1 & 0 \\ 0 & 1 \\ 1 & 0 \\ 0 & 1 \end{bmatrix}$	$\frac{1}{2} \begin{bmatrix} 1 & 0 \\ 0 & 1 \\ 1 & 0 \\ 0 & -1 \end{bmatrix}$	$\frac{1}{2} \begin{bmatrix} 1 & 0 \\ 0 & 1 \\ -1 & 0 \\ 0 & 1 \end{bmatrix}$	$\frac{1}{2} \begin{bmatrix} 1 & 0 \\ 0 & 1 \\ -1 & 0 \\ 0 & -1 \end{bmatrix}$
12-15	$\frac{1}{2} \begin{bmatrix} 1 & 0 \\ 0 & 1 \\ 0 & 1 \\ 1 & 0 \end{bmatrix}$	$\frac{1}{2} \begin{bmatrix} 1 & 0 \\ 0 & 1 \\ 0 & -1 \\ 1 & 0 \end{bmatrix}$	$\frac{1}{2} \begin{bmatrix} 1 & 0 \\ 0 & 1 \\ 0 & 1 \\ -1 & 0 \end{bmatrix}$	$\frac{1}{2} \begin{bmatrix} 1 & 0 \\ 0 & 1 \\ 0 & -1 \\ -1 & 0 \end{bmatrix}$

Table 5.3.3A.2-4: Codebook for transmission on antenna ports {40,41,42,43} with $v = 3$.

Codebook index	Number of layers $v = 3$			
0-3	$\frac{1}{2} \begin{bmatrix} 1 & 0 & 0 \\ 1 & 0 & 0 \\ 0 & 1 & 0 \\ 0 & 0 & 1 \end{bmatrix}$	$\frac{1}{2} \begin{bmatrix} 1 & 0 & 0 \\ -1 & 0 & 0 \\ 0 & 1 & 0 \\ 0 & 0 & 1 \end{bmatrix}$	$\frac{1}{2} \begin{bmatrix} 1 & 0 & 0 \\ 0 & 1 & 0 \\ 1 & 0 & 0 \\ 0 & 0 & 1 \end{bmatrix}$	$\frac{1}{2} \begin{bmatrix} 1 & 0 & 0 \\ 0 & 1 & 0 \\ -1 & 0 & 0 \\ 0 & 0 & 1 \end{bmatrix}$
4-7	$\frac{1}{2} \begin{bmatrix} 1 & 0 & 0 \\ 0 & 1 & 0 \\ 0 & 0 & 1 \\ 1 & 0 & 0 \end{bmatrix}$	$\frac{1}{2} \begin{bmatrix} 1 & 0 & 0 \\ 0 & 1 & 0 \\ 0 & 0 & 1 \\ -1 & 0 & 0 \end{bmatrix}$	$\frac{1}{2} \begin{bmatrix} 0 & 1 & 0 \\ 1 & 0 & 0 \\ 1 & 0 & 0 \\ 0 & 0 & 1 \end{bmatrix}$	$\frac{1}{2} \begin{bmatrix} 0 & 1 & 0 \\ 1 & 0 & 0 \\ -1 & 0 & 0 \\ 0 & 0 & 1 \end{bmatrix}$
8-11	$\frac{1}{2} \begin{bmatrix} 0 & 1 & 0 \\ 1 & 0 & 0 \\ 0 & 0 & 1 \\ 1 & 0 & 0 \end{bmatrix}$	$\frac{1}{2} \begin{bmatrix} 0 & 1 & 0 \\ 1 & 0 & 0 \\ 0 & 0 & 1 \\ -1 & 0 & 0 \end{bmatrix}$	$\frac{1}{2} \begin{bmatrix} 0 & 1 & 0 \\ 0 & 0 & 1 \\ 1 & 0 & 0 \\ 1 & 0 & 0 \end{bmatrix}$	$\frac{1}{2} \begin{bmatrix} 0 & 1 & 0 \\ 0 & 0 & 1 \\ 1 & 0 & 0 \\ -1 & 0 & 0 \end{bmatrix}$

Table 5.3.3A.2-5: Codebook for transmission on antenna ports {40,41,42,43} with $v = 4$.

Codebook index	Number of layers $v = 4$
0	$\frac{1}{2} \begin{bmatrix} 1 & 0 & 0 & 0 \\ 0 & 1 & 0 & 0 \\ 0 & 0 & 1 & 0 \\ 0 & 0 & 0 & 1 \end{bmatrix}$

5.3.4 Mapping to physical resources

For each antenna port p used for transmission of the PUSCH in a subframe the block of complex-valued symbols $z^{(\tilde{p})}(0), \dots, z^{(\tilde{p})}(M_{\text{sym}}^{\text{ap}} - 1)$ shall be multiplied with the amplitude scaling factor β_{PUSCH} in order to conform to the transmit power P_{PUSCH} specified in Section 5.1.1.1 in [4], and mapped in sequence starting with $z^{(\tilde{p})}(0)$ to physical resource blocks on antenna port p and assigned for transmission of PUSCH. The relation between the index \tilde{p} and the antenna port number p is given by Table 5.2.1-1. The mapping to resource elements (k, l) corresponding to the physical resource blocks assigned for transmission and

- not used for transmission of reference signals, and
- not part of the last SC-FDMA symbol in a subframe, if the UE transmits SRS in the same subframe, and
- not part of the last SC-FDMA symbol in a subframe configured with cell-specific SRS, if the PUSCH transmission partly or fully overlaps with the cell-specific SRS bandwidth, and
- not part of an SC-FDMA symbol reserved for possible SRS transmission in a UE-specific aperiodic SRS subframe, and
- not part of an SC-FDMA symbol reserved for possible SRS transmission in a UE-specific periodic SRS subframe in the same serving cell when the UE is configured with multiple TAGs

shall be in increasing order of first the index k , then the index l , starting with the first slot in the subframe.

If uplink frequency-hopping is disabled or the resource blocks allocated for PUSCH transmission are not contiguous in frequency, the set of physical resource blocks to be used for transmission is given by $n_{\text{PRB}} = n_{\text{VRB}}$ where n_{VRB} is obtained from the uplink scheduling grant as described in Section 8.1 in [4].

If uplink frequency-hopping with type 1 PUSCH hopping is enabled, the set of physical resource blocks to be used for transmission is given by Section 8.4.1 in [4].

If uplink frequency-hopping with predefined hopping pattern is enabled, the set of physical resource blocks to be used for transmission in slot n_s is given by the scheduling grant together with a predefined pattern according to

$$\begin{aligned} \tilde{n}_{\text{PRB}}(n_s) &= \left(\tilde{n}_{\text{VRB}} + f_{\text{hop}}(i) \cdot N_{\text{RB}}^{\text{sb}} + \left((N_{\text{RB}}^{\text{sb}} - 1) - 2(\tilde{n}_{\text{VRB}} \bmod N_{\text{RB}}^{\text{sb}}) \right) \cdot f_{\text{m}}(i) \right) \bmod (N_{\text{RB}}^{\text{sb}} \cdot N_{\text{sb}}) \\ i &= \begin{cases} \lfloor n_s / 2 \rfloor & \text{inter - subframe hopping} \\ n_s & \text{intra and inter - subframe hopping} \end{cases} \\ n_{\text{PRB}}(n_s) &= \begin{cases} \tilde{n}_{\text{PRB}}(n_s) & N_{\text{sb}} = 1 \\ \tilde{n}_{\text{PRB}}(n_s) + \lfloor N_{\text{RB}}^{\text{HO}} / 2 \rfloor & N_{\text{sb}} > 1 \end{cases} \\ \tilde{n}_{\text{VRB}} &= \begin{cases} n_{\text{VRB}} & N_{\text{sb}} = 1 \\ n_{\text{VRB}} - \lfloor N_{\text{RB}}^{\text{HO}} / 2 \rfloor & N_{\text{sb}} > 1 \end{cases} \end{aligned}$$

where n_{VRB} is obtained from the scheduling grant as described in Section 8.1 in [4]. The parameter *pusch-HoppingOffset*, $N_{\text{RB}}^{\text{HO}}$, is provided by higher layers. The size $N_{\text{RB}}^{\text{sb}}$ of each sub-band is given by,

$$N_{\text{RB}}^{\text{sb}} = \begin{cases} N_{\text{RB}}^{\text{UL}} & N_{\text{sb}} = 1 \\ \lfloor (N_{\text{RB}}^{\text{UL}} - N_{\text{RB}}^{\text{HO}} - N_{\text{RB}}^{\text{HO}} \bmod 2) / N_{\text{sb}} \rfloor & N_{\text{sb}} > 1 \end{cases}$$

where the number of sub-bands N_{sb} is given by higher layers. The function $f_{\text{m}}(i) \in \{0, 1\}$ determines whether mirroring is used or not. The parameter *Hopping-mode* provided by higher layers determines if hopping is 'inter-subframe' or 'intra and inter-subframe'.

The hopping function $f_{\text{hop}}(i)$ and the function $f_{\text{m}}(i)$ are given by

$$f_{\text{hop}}(i) = \begin{cases} 0 & N_{\text{sb}} = 1 \\ (f_{\text{hop}}(i-1) + \sum_{k=i-10+1}^{i-10+9} c(k) \times 2^{k-(i-10+1)}) \bmod N_{\text{sb}} & N_{\text{sb}} = 2 \\ (f_{\text{hop}}(i-1) + \left(\sum_{k=i-10+1}^{i-10+9} c(k) \times 2^{k-(i-10+1)} \right) \bmod (N_{\text{sb}} - 1) + 1) \bmod N_{\text{sb}} & N_{\text{sb}} > 2 \end{cases}$$

$$f_m(i) = \begin{cases} i \bmod 2 & N_{\text{sb}} = 1 \text{ and intra and inter - subframe hopping} \\ \text{CURRENT_TX_NB} \bmod 2 & N_{\text{sb}} = 1 \text{ and inter - subframe hopping} \\ c(i \cdot 10) & N_{\text{sb}} > 1 \end{cases}$$

where $f_{\text{hop}}(-1) = 0$ and the pseudo-random sequence $c(i)$ is given by section 7.2 and CURRENT_TX_NB indicates the transmission number for the transport block transmitted in slot n_s as defined in [8]. The pseudo-random sequence generator shall be initialised with $c_{\text{init}} = N_{\text{ID}}^{\text{cell}}$ for frame structure type 1 and $c_{\text{init}} = 2^9 \cdot (n_f \bmod 4) + N_{\text{ID}}^{\text{cell}}$ for frame structure type 2 at the start of each frame.

5.4 Physical uplink control channel

The physical uplink control channel, PUCCH, carries uplink control information. Simultaneous transmission of PUCCH and PUSCH from the same UE is supported if enabled by higher layers. For frame structure type 2, the PUCCH is not transmitted in the UpPTS field.

The physical uplink control channel supports multiple formats as shown in Table 5.4-1. Formats 2a and 2b are supported for normal cyclic prefix only.

Table 5.4-1: Supported PUCCH formats.

PUCCH format	Modulation scheme	Number of bits per subframe, M_{bit}
1	N/A	N/A
1a	BPSK	1
1b	QPSK	2
2	QPSK	20
2a	QPSK+BPSK	21
2b	QPSK+QPSK	22
3	QPSK	48

All PUCCH formats use a cyclic shift, $n_{\text{cs}}^{\text{cell}}(n_s, l)$, which varies with the symbol number l and the slot number n_s according to

$$n_{\text{cs}}^{\text{cell}}(n_s, l) = \sum_{i=0}^7 c(8N_{\text{symb}}^{\text{UL}} \cdot n_s + 8l + i) \cdot 2^i$$

where the pseudo-random sequence $c(i)$ is defined by section 7.2. The pseudo-random sequence generator shall be initialized with $c_{\text{init}} = n_{\text{ID}}^{\text{RS}}$, where $n_{\text{ID}}^{\text{RS}}$ is given by Section 5.5.1.5 with $N_{\text{ID}}^{\text{cell}}$ corresponding to the primary cell, at the beginning of each radio frame.

The physical resources used for PUCCH depends on two parameters, $N_{\text{RB}}^{(2)}$ and $N_{\text{cs}}^{(1)}$, given by higher layers. The variable $N_{\text{RB}}^{(2)} \geq 0$ denotes the bandwidth in terms of resource blocks that are available for use by PUCCH formats 2/2a/2b transmission in each slot. The variable $N_{\text{cs}}^{(1)}$ denotes the number of cyclic shift used for PUCCH formats 1/1a/1b in a resource block used for a mix of formats 1/1a/1b and 2/2a/2b. The value of $N_{\text{cs}}^{(1)}$ is an integer multiple of $\Delta_{\text{shift}}^{\text{PUCCH}}$ within the range of $\{0, 1, \dots, 7\}$, where $\Delta_{\text{shift}}^{\text{PUCCH}}$ is provided by higher layers. No mixed resource block is present if $N_{\text{cs}}^{(1)} = 0$. At most one resource block in each slot supports a mix of formats 1/1a/1b and 2/2a/2b. Resources

used for transmission of PUCCH formats 1/1a/1b, 2/2a/2b and 3 are represented by the non-negative indices $n_{\text{PUCCH}}^{(1,\tilde{p})}$,

$$n_{\text{PUCCH}}^{(2,\tilde{p})} < N_{\text{RB}}^{(2)} N_{\text{sc}}^{\text{RB}} + \left\lceil \frac{N_{\text{cs}}^{(1)}}{8} \right\rceil \cdot (N_{\text{sc}}^{\text{RB}} - N_{\text{cs}}^{(1)} - 2), \text{ and } n_{\text{PUCCH}}^{(3,\tilde{p})}, \text{ respectively.}$$

5.4.1 PUCCH formats 1, 1a and 1b

For PUCCH format 1, information is carried by the presence/absence of transmission of PUCCH from the UE. In the remainder of this section, $d(0) = 1$ shall be assumed for PUCCH format 1.

For PUCCH formats 1a and 1b, one or two explicit bits are transmitted, respectively. The block of bits $b(0), \dots, b(M_{\text{bit}} - 1)$ shall be modulated as described in Table 5.4.1-1, resulting in a complex-valued symbol $d(0)$. The modulation schemes for the different PUCCH formats are given by Table 5.4-1.

The complex-valued symbol $d(0)$ shall be multiplied with a cyclically shifted length $N_{\text{seq}}^{\text{PUCCH}} = 12$ sequence $r_{u,v}^{(\alpha_{\tilde{p}})}(n)$ for each of the P antenna ports used for PUCCH transmission according to

$$y^{(\tilde{p})}(n) = \frac{1}{\sqrt{P}} d(0) \cdot r_{u,v}^{(\alpha_{\tilde{p}})}(n), \quad n = 0, 1, \dots, N_{\text{seq}}^{\text{PUCCH}} - 1$$

where $r_{u,v}^{(\alpha_{\tilde{p}})}(n)$ is defined by section 5.5.1 with $M_{\text{sc}}^{\text{RS}} = N_{\text{seq}}^{\text{PUCCH}}$. The antenna-port specific cyclic shift $\alpha_{\tilde{p}}$ varies between symbols and slots as defined below.

The block of complex-valued symbols $y^{(\tilde{p})}(0), \dots, y^{(\tilde{p})}(N_{\text{seq}}^{\text{PUCCH}} - 1)$ shall be scrambled by $S(n_s)$ and block-wise spread with the antenna-port specific orthogonal sequence $w_{n_{\text{oc}}}^{(\tilde{p})}(i)$ according to

$$z^{(\tilde{p})}(m' \cdot N_{\text{SF}}^{\text{PUCCH}} \cdot N_{\text{seq}}^{\text{PUCCH}} + m \cdot N_{\text{seq}}^{\text{PUCCH}} + n) = S(n_s) \cdot w_{n_{\text{oc}}}^{(\tilde{p})}(m) \cdot y^{(\tilde{p})}(n)$$

where

$$\begin{aligned} m &= 0, \dots, N_{\text{SF}}^{\text{PUCCH}} - 1 \\ n &= 0, \dots, N_{\text{seq}}^{\text{PUCCH}} - 1 \\ m' &= 0, 1 \end{aligned}$$

and

$$S(n_s) = \begin{cases} 1 & \text{if } n'_p(n_s) \bmod 2 = 0 \\ e^{j\pi/2} & \text{otherwise} \end{cases}$$

with $N_{\text{SF}}^{\text{PUCCH}} = 4$ for both slots of normal PUCCH formats 1/1a/1b, and $N_{\text{SF}}^{\text{PUCCH}} = 4$ for the first slot and $N_{\text{SF}}^{\text{PUCCH}} = 3$ for the second slot of shortened PUCCH formats 1/1a/1b. The sequence $w_{n_{\text{oc}}}^{(\tilde{p})}(i)$ is given by Table 5.4.1-2 and Table 5.4.1-3 and $n'_p(n_s)$ is defined below.

Resources used for transmission of PUCCH format 1, 1a and 1b are identified by a resource index $n_{\text{PUCCH}}^{(1,\tilde{p})}$ from which the orthogonal sequence index $n_{\text{oc}}^{(\tilde{p})}(n_s)$ and the cyclic shift $\alpha_{\tilde{p}}(n_s, l)$ are determined according to

$$n_{oc}^{(\tilde{p})}(n_s) = \begin{cases} \lfloor n'_{\tilde{p}}(n_s) \cdot \Delta_{\text{shift}}^{\text{PUCCH}} / N' \rfloor & \text{for normal cyclic prefix} \\ 2 \cdot \lfloor n'_{\tilde{p}}(n_s) \cdot \Delta_{\text{shift}}^{\text{PUCCH}} / N' \rfloor & \text{for extended cyclic prefix} \end{cases}$$

$$\alpha_{\tilde{p}}(n_s, l) = 2\pi \cdot n_{cs}^{(\tilde{p})}(n_s, l) / N_{sc}^{\text{RB}}$$

$$n_{cs}^{(\tilde{p})}(n_s, l) = \begin{cases} \left[n_{cs}^{\text{cell}}(n_s, l) + \left(n'_{\tilde{p}}(n_s) \cdot \Delta_{\text{shift}}^{\text{PUCCH}} + (n_{oc}^{(\tilde{p})}(n_s) \bmod \Delta_{\text{shift}}^{\text{PUCCH}}) \right) \bmod N' \right] \bmod N_{sc}^{\text{RB}} & \text{for normal cyclic prefix} \\ \left[n_{cs}^{\text{cell}}(n_s, l) + \left(n'_{\tilde{p}}(n_s) \cdot \Delta_{\text{shift}}^{\text{PUCCH}} + n_{oc}^{(\tilde{p})}(n_s) / 2 \right) \bmod N' \right] \bmod N_{sc}^{\text{RB}} & \text{for extended cyclic prefix} \end{cases}$$

where

$$N' = \begin{cases} N_{cs}^{(1)} & \text{if } n_{\text{PUCCH}}^{(1, \tilde{p})} < c \cdot N_{cs}^{(1)} / \Delta_{\text{shift}}^{\text{PUCCH}} \\ N_{sc}^{\text{RB}} & \text{otherwise} \end{cases}$$

$$c = \begin{cases} 3 & \text{normal cyclic prefix} \\ 2 & \text{extended cyclic prefix} \end{cases}$$

The resource indices within the two resource blocks in the two slots of a subframe to which the PUCCH is mapped are given by

$$n'_{\tilde{p}}(n_s) = \begin{cases} n_{\text{PUCCH}}^{(1, \tilde{p})} & \text{if } n_{\text{PUCCH}}^{(1, \tilde{p})} < c \cdot N_{cs}^{(1)} / \Delta_{\text{shift}}^{\text{PUCCH}} \\ \left(n_{\text{PUCCH}}^{(1, \tilde{p})} - c \cdot N_{cs}^{(1)} / \Delta_{\text{shift}}^{\text{PUCCH}} \right) \bmod \left(c \cdot N_{sc}^{\text{RB}} / \Delta_{\text{shift}}^{\text{PUCCH}} \right) & \text{otherwise} \end{cases}$$

for $n_s \bmod 2 = 0$ and by

$$n'_{\tilde{p}}(n_s) = \begin{cases} \left[c(n'_{\tilde{p}}(n_s - 1) + 1) \right] \bmod \left(cN_{sc}^{\text{RB}} / \Delta_{\text{shift}}^{\text{PUCCH}} + 1 \right) - 1 & n_{\text{PUCCH}}^{(1, \tilde{p})} \geq c \cdot N_{cs}^{(1)} / \Delta_{\text{shift}}^{\text{PUCCH}} \\ \left[h_{\tilde{p}} / c \right] + (h_{\tilde{p}} \bmod c) N' / \Delta_{\text{shift}}^{\text{PUCCH}} & \text{otherwise} \end{cases}$$

for $n_s \bmod 2 = 1$, where $h_{\tilde{p}} = (n'_{\tilde{p}}(n_s - 1) + d) \bmod (cN' / \Delta_{\text{shift}}^{\text{PUCCH}})$, with $d = 2$ for normal CP and $d = 0$ for extended CP.

The parameter *deltaPUCCH-Shift* $\Delta_{\text{shift}}^{\text{PUCCH}}$ is provided by higher layers.

Table 5.4.1-1: Modulation symbol $d(0)$ for PUCCH formats 1a and 1b.

PUCCH format	$b(0), \dots, b(M_{\text{bit}} - 1)$	$d(0)$
1a	0	1
	1	-1
1b	00	1
	01	-j
	10	j
	11	-1

Table 5.4.1-2: Orthogonal sequences $[w(0) \dots w(N_{\text{SF}}^{\text{PUCCH}} - 1)]$ for $N_{\text{SF}}^{\text{PUCCH}} = 4$.

Sequence index $n_{oc}^{(\tilde{p})}(n_s)$	Orthogonal sequences $[w(0) \dots w(N_{\text{SF}}^{\text{PUCCH}} - 1)]$
0	[+1 +1 +1 +1]
1	[+1 -1 +1 -1]
2	[+1 -1 -1 +1]

Table 5.4.1-3: Orthogonal sequences $\left[w(0) \dots w(N_{\text{SF}}^{\text{PUCCH}} - 1) \right]$ for $N_{\text{SF}}^{\text{PUCCH}} = 3$.

Sequence index $n_{\text{oc}}^{(\tilde{p})}(n_s)$	Orthogonal sequences $\left[w(0) \dots w(N_{\text{SF}}^{\text{PUCCH}} - 1) \right]$
0	$[1 \ 1 \ 1]$
1	$\left[1 \ e^{j2\pi/3} \ e^{j4\pi/3} \right]$
2	$\left[1 \ e^{j4\pi/3} \ e^{j2\pi/3} \right]$

5.4.2 PUCCH formats 2, 2a and 2b

The block of bits $b(0), \dots, b(19)$ shall be scrambled with a UE-specific scrambling sequence, resulting in a block of scrambled bits $\tilde{b}(0), \dots, \tilde{b}(19)$ according to

$$\tilde{b}(i) = (b(i) + c(i)) \bmod 2$$

where the scrambling sequence $c(i)$ is given by Section 7.2. The scrambling sequence generator shall be initialised with $c_{\text{init}} = (\lfloor n_s/2 \rfloor + 1) \cdot (2N_{\text{ID}}^{\text{cell}} + 1) \cdot 2^{16} + n_{\text{RNTI}}$ at the start of each subframe where n_{RNTI} is C-RNTI.

The block of scrambled bits $\tilde{b}(0), \dots, \tilde{b}(19)$ shall be QPSK modulated as described in Section 7.1, resulting in a block of complex-valued modulation symbols $d(0), \dots, d(9)$.

Each complex-valued symbol $d(0), \dots, d(9)$ shall be multiplied with a cyclically shifted length $N_{\text{seq}}^{\text{PUCCH}} = 12$ sequence $r_{u,v}^{(\alpha_{\tilde{p}})}(n)$ for each of the P antenna ports used for PUCCH transmission according to

$$z^{(\tilde{p})}(N_{\text{seq}}^{\text{PUCCH}} \cdot n + i) = \frac{1}{\sqrt{P}} d(n) \cdot r_{u,v}^{(\alpha_{\tilde{p}})}(i)$$

$$n = 0, 1, \dots, 9$$

$$i = 0, 1, \dots, N_{\text{sc}}^{\text{RB}} - 1$$

where $r_{u,v}^{(\alpha_{\tilde{p}})}(i)$ is defined by section 5.5.1 with $M_{\text{sc}}^{\text{RS}} = N_{\text{seq}}^{\text{PUCCH}}$.

Resources used for transmission of PUCCH formats 2/2a/2b are identified by a resource index $n_{\text{PUCCH}}^{(2,\tilde{p})}$ from which the cyclic shift $\alpha_{\tilde{p}}(n_s, l)$ is determined according to

$$\alpha_{\tilde{p}}(n_s, l) = 2\pi \cdot n_{\text{cs}}^{(\tilde{p})}(n_s, l) / N_{\text{sc}}^{\text{RB}}$$

where

$$n_{\text{cs}}^{(\tilde{p})}(n_s, l) = (n_{\text{cs}}^{\text{cell}}(n_s, l) + n'_{\tilde{p}}(n_s)) \bmod N_{\text{sc}}^{\text{RB}}$$

and

$$n'_{\tilde{p}}(n_s) = \begin{cases} n_{\text{PUCCH}}^{(2,\tilde{p})} \bmod N_{\text{sc}}^{\text{RB}} & \text{if } n_{\text{PUCCH}}^{(2,\tilde{p})} < N_{\text{sc}}^{\text{RB}} N_{\text{RB}}^{(2)} \\ (n_{\text{PUCCH}}^{(2,\tilde{p})} + N_{\text{cs}}^{(1)} + 1) \bmod N_{\text{sc}}^{\text{RB}} & \text{otherwise} \end{cases}$$

for $n_s \bmod 2 = 0$ and by

$$n'_{\tilde{p}}(n_s) = \begin{cases} \left[N_{sc}^{RB} (n'_{\tilde{p}}(n_s - 1) + 1) \right] \bmod (N_{sc}^{RB} + 1) - 1 & \text{if } n_{PUCCH}^{(2,\tilde{p})} < N_{sc}^{RB} N_{RB}^{(2)} \\ \left(N_{sc}^{RB} - 2 - n_{PUCCH}^{(2,\tilde{p})} \right) \bmod N_{sc}^{RB} & \text{otherwise} \end{cases}$$

for $n_s \bmod 2 = 1$.

For PUCCH formats 2a and 2b, supported for normal cyclic prefix only, the bit(s) $b(20), \dots, b(M_{bit} - 1)$ shall be modulated as described in Table 5.4.2-1 resulting in a single modulation symbol $d(10)$ used in the generation of the reference-signal for PUCCH format 2a and 2b as described in Section 5.5.2.2.1.

Table 5.4.2-1: Modulation symbol $d(10)$ for PUCCH formats 2a and 2b.

PUCCH format	$b(20), \dots, b(M_{bit} - 1)$	$d(10)$
2a	0	1
	1	-1
2b	00	1
	01	-j
	10	j
	11	-1

5.4.2A PUCCH format 3

The block of bits $b(0), \dots, b(M_{bit} - 1)$ shall be scrambled with a UE-specific scrambling sequence, resulting in a block of scrambled bits $\tilde{b}(0), \dots, \tilde{b}(M_{bit} - 1)$ according to

$$\tilde{b}(i) = (b(i) + c(i)) \bmod 2$$

where the scrambling sequence $c(i)$ is given by Section 7.2. The scrambling sequence generator shall be initialised with $c_{init} = (\lfloor n_s/2 \rfloor + 1) \cdot (2N_{ID}^{cell} + 1) \cdot 2^{16} + n_{RNTI}$ at the start of each subframe where n_{RNTI} is the C-RNTI.

The block of scrambled bits $\tilde{b}(0), \dots, \tilde{b}(M_{bit} - 1)$ shall be QPSK modulated as described in Section 7.1, resulting in a block of complex-valued modulation symbols $d(0), \dots, d(M_{symb} - 1)$ where $M_{symb} = M_{bit}/2 = 2N_{sc}^{RB}$.

The complex-valued symbols $d(0), \dots, d(M_{symb} - 1)$ shall be block-wise spread with the orthogonal sequences $w_{n_{oc,0}}^{(\tilde{p})}(i)$ and $w_{n_{oc,1}}^{(\tilde{p})}(i)$ resulting in $N_{SF,0}^{PUCCH} + N_{SF,1}^{PUCCH}$ sets of N_{sc}^{RB} values each according to

$$y_n^{(\tilde{p})}(i) = \begin{cases} w_{n_{oc,0}}^{(\tilde{p})}(\bar{n}) \cdot e^{j\pi \lfloor n_{cs}^{cell}(n_s, l) / 64 \rfloor / 2} \cdot d(i) & n < N_{SF,0}^{PUCCH} \\ w_{n_{oc,1}}^{(\tilde{p})}(\bar{n}) \cdot e^{j\pi \lfloor n_{cs}^{cell}(n_s, l) / 64 \rfloor / 2} \cdot d(N_{sc}^{RB} + i) & \text{otherwise} \end{cases}$$

$$\bar{n} = n \bmod N_{SF,0}^{PUCCH}$$

$$n = 0, \dots, N_{SF,0}^{PUCCH} + N_{SF,1}^{PUCCH} - 1$$

$$i = 0, 1, \dots, N_{sc}^{RB} - 1$$

where $N_{SF,0}^{PUCCH} = N_{SF,1}^{PUCCH} = 5$ for both slots in a subframe using normal PUCCH format 3 and $N_{SF,0}^{PUCCH} = 5$, $N_{SF,1}^{PUCCH} = 4$ holds for the first and second slot, respectively, in a subframe using shortened PUCCH format 3. The orthogonal sequences $w_{n_{oc,0}}^{(\tilde{p})}(i)$ and $w_{n_{oc,1}}^{(\tilde{p})}(i)$ are given by Table 5.4.2A-1. Resources used for transmission of PUCCH formats 3 are identified by a resource index $n_{PUCCH}^{(3,\tilde{p})}$ from which the quantities $n_{oc,0}^{(\tilde{p})}$ and $n_{oc,1}^{(\tilde{p})}$ are derived according to

$$n_{oc,0}^{(\tilde{p})} = n_{PUCCH}^{(3,\tilde{p})} \bmod N_{SF,1}^{PUCCH}$$

$$n_{oc,1}^{(\tilde{p})} = \begin{cases} (3n_{oc,0}^{(\tilde{p})}) \bmod N_{SF,1}^{PUCCH} & \text{if } N_{SF,1}^{PUCCH} = 5 \\ n_{oc,0}^{(\tilde{p})} \bmod N_{SF,1}^{PUCCH} & \text{otherwise} \end{cases}$$

Each set of complex-valued symbols shall be cyclically shifted according to

$$\tilde{y}_n^{(\tilde{p})}(i) = y_n^{(\tilde{p})} \left((i + n_{cs}^{cell}(n_s, l)) \bmod N_{sc}^{RB} \right)$$

where $n_{cs}^{cell}(n_s, l)$ is given by Section 5.4, n_s is the slot number within a radio frame and l is the SC-FDMA symbol number within a slot.

The shifted sets of complex-valued symbols shall be transform precoded according to

$$z^{(\tilde{p})}(n \cdot N_{sc}^{RB} + k) = \frac{1}{\sqrt{P}} \frac{1}{\sqrt{N_{sc}^{RB}}} \sum_{i=0}^{N_{sc}^{RB}-1} \tilde{y}_n^{(\tilde{p})}(i) e^{-j \frac{2\pi k i}{N_{sc}^{RB}}}$$

$$k = 0, \dots, N_{sc}^{RB} - 1$$

$$n = 0, \dots, N_{SF,0}^{PUCCH} + N_{SF,1}^{PUCCH} - 1$$

where P is the number of antenna ports used for PUCCH transmission, resulting in a block of complex-valued symbols $z^{(\tilde{p})}(0), \dots, z^{(\tilde{p})} \left((N_{SF,0}^{PUCCH} + N_{SF,1}^{PUCCH}) N_{sc}^{RB} - 1 \right)$.

Table 5.4.2A-1: The orthogonal sequence $w_{n_{oc}}(i)$.

Sequence index n_{oc}	Orthogonal sequence $[w_{n_{oc}}(0) \dots w_{n_{oc}}(N_{SF}^{PUCCH} - 1)]$	
	$N_{SF}^{PUCCH} = 5$	$N_{SF}^{PUCCH} = 4$
0	[1 1 1 1 1]	[+1 +1 +1 +1]
1	[1 $e^{j2\pi/5}$ $e^{j4\pi/5}$ $e^{j6\pi/5}$ $e^{j8\pi/5}$]	[+1 -1 +1 -1]
2	[1 $e^{j4\pi/5}$ $e^{j8\pi/5}$ $e^{j2\pi/5}$ $e^{j6\pi/5}$]	[+1 +1 -1 -1]
3	[1 $e^{j6\pi/5}$ $e^{j2\pi/5}$ $e^{j8\pi/5}$ $e^{j4\pi/5}$]	[+1 -1 -1 +1]
4	[1 $e^{j8\pi/5}$ $e^{j6\pi/5}$ $e^{j4\pi/5}$ $e^{j2\pi/5}$]	-

5.4.3 Mapping to physical resources

The block of complex-valued symbols $z^{(\tilde{p})}(i)$ shall be multiplied with the amplitude scaling factor β_{PUCCH} in order to conform to the transmit power P_{PUCCH} specified in Section 5.1.2.1 in [4], and mapped in sequence starting with $z^{(\tilde{p})}(0)$ to resource elements. PUCCH uses one resource block in each of the two slots in a subframe. Within the physical resource block used for transmission, the mapping of $z^{(\tilde{p})}(i)$ to resource elements (k, l) on antenna port p and not used for transmission of reference signals shall be in increasing order of first k , then l and finally the slot number, starting with the first slot in the subframe. The relation between the index \tilde{p} and the antenna port number p is given by Table 5.2.1-1.

The physical resource blocks to be used for transmission of PUCCH in slot n_s are given by

$$n_{PRB} = \begin{cases} \left\lfloor \frac{m}{2} \right\rfloor & \text{if } (m + n_s \bmod 2) \bmod 2 = 0 \\ N_{RB}^{UL} - 1 - \left\lfloor \frac{m}{2} \right\rfloor & \text{if } (m + n_s \bmod 2) \bmod 2 = 1 \end{cases}$$

where the variable m depends on the PUCCH format. For formats 1, 1a and 1b

$$m = \begin{cases} N_{RB}^{(2)} & \text{if } n_{PUCCH}^{(1,\tilde{p})} < c \cdot N_{cs}^{(1)} / \Delta_{shift}^{PUCCH} \\ \left\lfloor \frac{n_{PUCCH}^{(1,\tilde{p})} - c \cdot N_{cs}^{(1)} / \Delta_{shift}^{PUCCH}}{c \cdot N_{sc}^{RB} / \Delta_{shift}^{PUCCH}} \right\rfloor + N_{RB}^{(2)} + \left\lfloor \frac{N_{cs}^{(1)}}{8} \right\rfloor & \text{otherwise} \end{cases}$$

$$c = \begin{cases} 3 & \text{normal cyclic prefix} \\ 2 & \text{extended cyclic prefix} \end{cases}$$

and for formats 2, 2a and 2b

$$m = \left\lfloor n_{PUCCH}^{(2,\tilde{p})} / N_{sc}^{RB} \right\rfloor$$

and for format 3

$$m = \left\lfloor n_{PUCCH}^{(3,\tilde{p})} / N_{SF,0}^{PUCCH} \right\rfloor$$

Mapping of modulation symbols for the physical uplink control channel is illustrated in Figure 5.4.3-1.

In case of simultaneous transmission of sounding reference signal and PUCCH format 1, 1a, 1b or 3 when there is one serving cell configured, a shortened PUCCH format shall be used where the last SC-FDMA symbol in the second slot of a subframe shall be left empty.

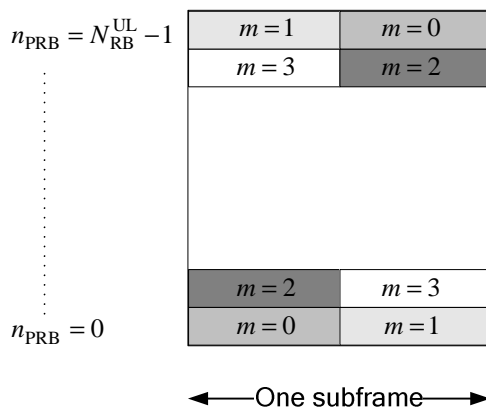

Figure 5.4.3-1: Mapping to physical resource blocks for PUCCH.

5.5 Reference signals

Two types of uplink reference signals are supported:

- Demodulation reference signal, associated with transmission of PUSCH or PUCCH
- Sounding reference signal, not associated with transmission of PUSCH or PUCCH

The same set of base sequences is used for demodulation and sounding reference signals.

5.5.1 Generation of the reference signal sequence

Reference signal sequence $r_{u,v}^{(\alpha)}(n)$ is defined by a cyclic shift α of a base sequence $\bar{r}_{u,v}(n)$ according to

$$r_{u,v}^{(\alpha)}(n) = e^{jcn} \bar{r}_{u,v}(n), \quad 0 \leq n < M_{sc}^{RS}$$

where $M_{sc}^{RS} = mN_{sc}^{RB}$ is the length of the reference signal sequence and $1 \leq m \leq N_{RB}^{\max,UL}$. Multiple reference signal sequences are defined from a single base sequence through different values of α .

Base sequences $\bar{r}_{u,v}(n)$ are divided into groups, where $u \in \{0,1,\dots,29\}$ is the group number and v is the base sequence number within the group, such that each group contains one base sequence ($v=0$) of each length $M_{sc}^{RS} = mN_{sc}^{RB}$, $1 \leq m \leq 5$ and two base sequences ($v=0,1$) of each length $M_{sc}^{RS} = mN_{sc}^{RB}$, $6 \leq m \leq N_{RB}^{\max,UL}$. The sequence group number u and the number v within the group may vary in time as described in Sections 5.5.1.3 and 5.5.1.4, respectively. The definition of the base sequence $\bar{r}_{u,v}(0), \dots, \bar{r}_{u,v}(M_{sc}^{RS} - 1)$ depends on the sequence length M_{sc}^{RS} .

5.5.1.1 Base sequences of length $3N_{sc}^{RB}$ or larger

For $M_{sc}^{RS} \geq 3N_{sc}^{RB}$, the base sequence $\bar{r}_{u,v}(0), \dots, \bar{r}_{u,v}(M_{sc}^{RS} - 1)$ is given by

$$\bar{r}_{u,v}(n) = x_q(n \bmod N_{ZC}^{RS}), \quad 0 \leq n < M_{sc}^{RS}$$

where the q^{th} root Zadoff-Chu sequence is defined by

$$x_q(m) = e^{-j \frac{\pi q m(m+1)}{N_{ZC}^{RS}}}, \quad 0 \leq m \leq N_{ZC}^{RS} - 1$$

with q given by

$$q = \lfloor \bar{q} + 1/2 \rfloor + v \cdot (-1)^{\lfloor 2\bar{q} \rfloor}$$

$$\bar{q} = N_{ZC}^{RS} \cdot (u+1)/31$$

The length N_{ZC}^{RS} of the Zadoff-Chu sequence is given by the largest prime number such that $N_{ZC}^{RS} < M_{sc}^{RS}$.

5.5.1.2 Base sequences of length less than $3N_{sc}^{RB}$

For $M_{sc}^{RS} = N_{sc}^{RB}$ and $M_{sc}^{RS} = 2N_{sc}^{RB}$, base sequence is given by

$$\bar{r}_{u,v}(n) = e^{j\varphi(n)\pi/4}, \quad 0 \leq n \leq M_{sc}^{RS} - 1$$

where the value of $\varphi(n)$ is given by Table 5.5.1.2-1 and Table 5.5.1.2-2 for $M_{sc}^{RS} = N_{sc}^{RB}$ and $M_{sc}^{RS} = 2N_{sc}^{RB}$, respectively.

Table 5.5.1.2-1: Definition of $\varphi(n)$ for $M_{sc}^{RS} = N_{sc}^{RB}$.

u	$\varphi(0), \dots, \varphi(11)$											
0	-1	1	3	-3	3	3	1	1	3	1	-3	3
1	1	1	3	3	3	-1	1	-3	-3	1	-3	3
2	1	1	-3	-3	-3	-1	-3	-3	1	-3	1	-1
3	-1	1	1	1	1	-1	-3	-3	1	-3	3	-1
4	-1	3	1	-1	1	-1	-3	-1	1	-1	1	3
5	1	-3	3	-1	-1	1	1	-1	-1	3	-3	1
6	-1	3	-3	-3	-3	3	1	-1	3	3	-3	1
7	-3	-1	-1	-1	1	-3	3	-1	1	-3	3	1
8	1	-3	3	1	-1	-1	-1	1	1	3	-1	1
9	1	-3	-1	3	3	-1	-3	1	1	1	1	1
10	-1	3	-1	1	1	-3	-3	-1	-3	-3	3	-1
11	3	1	-1	-1	3	3	-3	1	3	1	3	3
12	1	-3	1	1	-3	1	1	1	-3	-3	-3	1
13	3	3	-3	3	-3	1	1	3	-1	-3	3	3
14	-3	1	-1	-3	-1	3	1	3	3	3	-1	1
15	3	-1	1	-3	-1	-1	1	1	3	1	-1	-3
16	1	3	1	-1	1	3	3	3	-1	-1	3	-1
17	-3	1	1	3	-3	3	-3	-3	3	1	3	-1
18	-3	3	1	1	-3	1	-3	-3	-1	-1	1	-3
19	-1	3	1	3	1	-1	-1	3	-3	-1	-3	-1
20	-1	-3	1	1	1	1	3	1	-1	1	-3	-1
21	-1	3	-1	1	-3	-3	-3	-3	-3	1	-1	-3
22	1	1	-3	-3	-3	-3	-1	3	-3	1	-3	3
23	1	1	-1	-3	-1	-3	1	-1	1	3	-1	1
24	1	1	3	1	3	3	-1	1	-1	-3	-3	1
25	1	-3	3	3	1	3	3	1	-3	-1	-1	3
26	1	3	-3	-3	3	-3	1	-1	-1	3	-1	-3
27	-3	-1	-3	-1	-3	3	1	-1	1	3	-3	-3
28	-1	3	-3	3	-1	3	3	-3	3	3	-1	-1
29	3	-3	-3	-1	-1	-3	-1	3	-3	3	1	-1

Table 5.5.1.2-2: Definition of $\varphi(n)$ for $M_{sc}^{RS} = 2N_{sc}^{RB}$.

u	$\varphi(0), \dots, \varphi(23)$																							
0	-1	3	1	-3	3	-1	1	3	-3	3	1	3	-3	3	1	1	-1	1	3	-3	3	-3	-1	-3
1	-3	3	-3	-3	-3	1	-3	-3	3	-1	1	1	1	3	1	-1	3	-3	-3	1	3	1	1	-3
2	3	-1	3	3	1	1	-3	3	3	3	3	1	-1	3	-1	1	1	-1	-3	-1	-1	1	3	3
3	-1	-3	1	1	3	-3	1	1	-3	-1	-1	1	3	1	3	1	-1	3	1	1	-3	-1	-3	-1
4	-1	-1	-1	-3	-3	-1	1	1	3	3	-1	3	-1	1	-1	-3	1	-1	-3	-3	1	-3	-1	-1
5	-3	1	1	3	-1	1	3	1	-3	1	-3	1	1	-1	-1	3	-1	-3	3	-3	-3	-3	1	1
6	1	1	-1	-1	3	-3	-3	3	-3	1	-1	-1	1	-1	1	1	-1	-3	-1	1	-1	3	-1	-3
7	-3	3	3	-1	-1	-3	-1	3	1	3	1	3	1	1	-1	3	1	-1	1	3	-3	-1	-1	1
8	-3	1	3	-3	1	-1	-3	3	-3	3	-1	-1	-1	-1	1	-3	-3	-3	1	-3	-3	-3	1	-3
9	1	1	-3	3	3	-1	-3	-1	3	-3	3	3	3	-1	1	1	-3	1	-1	1	1	-3	1	1
10	-1	1	-3	-3	3	-1	3	-1	-1	-3	-3	-3	-3	-1	-3	-3	1	-1	1	3	3	-1	1	-1
11	1	3	3	-3	-3	1	3	1	-1	-3	-3	-3	3	3	-3	3	3	-1	-3	3	-1	1	-3	1
12	1	3	3	1	1	1	-1	-1	1	-3	3	-1	1	1	-3	3	3	-1	-3	3	-3	-1	-3	-1
13	3	-1	-1	-1	-1	-3	-1	3	3	1	-1	1	3	3	3	-1	1	1	-3	1	3	-1	-3	3
14	-3	-3	3	1	3	1	-3	3	1	3	1	1	3	3	-1	-1	-3	1	-3	-1	3	1	1	3
15	-1	-1	1	-3	1	3	-3	1	-1	-3	-1	3	1	3	1	-1	-3	-3	-1	-1	-3	-3	-3	-1
16	-1	-3	3	-1	-1	-1	-1	1	1	-3	3	1	3	3	1	-1	1	-3	1	-3	1	1	-3	-1
17	1	3	-1	3	3	-1	-3	1	-1	-3	3	3	3	-1	1	1	3	-1	-3	-1	3	-1	-1	-1
18	1	1	1	1	1	-1	3	-1	-3	1	1	3	-3	1	-3	-1	1	1	-3	-3	3	1	1	-3
19	1	3	3	1	-1	-3	3	-1	3	3	3	3	-3	1	-1	1	-3	-1	1	3	-1	3	-3	-3
20	-1	-3	3	-3	-3	-3	-1	-3	-1	-3	3	1	3	-3	-1	3	-1	1	-1	3	-3	1	-1	-1
21	-3	-3	1	1	-1	1	-1	1	-1	3	1	-3	-1	1	-1	1	-1	-1	3	3	-3	-1	1	-3
22	-3	-1	-3	3	1	-1	-3	-1	-3	-3	3	-3	3	-3	-1	1	3	1	-3	1	3	3	-1	-3
23	-1	-1	-1	-1	3	3	3	1	3	3	-3	1	3	-1	3	-1	3	3	-3	3	1	-1	3	3
24	1	-1	3	3	-1	-3	3	-3	-1	-1	3	-1	3	-1	-1	1	1	1	1	-1	-1	-3	-1	3
25	1	-1	1	-1	3	-1	3	1	1	-1	-1	-3	1	1	-3	1	3	-3	1	1	-3	-3	-1	-1
26	-3	-1	1	3	1	1	-3	-1	-1	-3	3	-3	3	1	-3	3	-3	1	-1	1	-3	1	1	1
27	-1	-3	3	3	1	1	3	-1	-3	-1	-1	-1	3	1	-3	-3	-1	3	-3	-1	-3	-1	-3	-1
28	-1	-3	-1	-1	1	-3	-1	-1	1	-1	-3	1	1	-3	1	-3	-3	3	1	1	-1	3	-1	-1
29	1	1	-1	-1	-3	-1	3	-1	3	-1	1	3	1	-1	3	1	3	-3	-3	1	-1	-1	1	3

5.5.1.3 Group hopping

The sequence-group number u in slot n_s is defined by a group hopping pattern $f_{gh}(n_s)$ and a sequence-shift pattern f_{ss} according to

$$u = (f_{gh}(n_s) + f_{ss}) \bmod 30$$

There are 17 different hopping patterns and 30 different sequence-shift patterns. Sequence-group hopping can be enabled or disabled by means of the cell-specific parameter *Group-hopping-enabled* provided by higher layers. Sequence-group hopping for PUSCH can be disabled for a certain UE through the higher-layer parameter *Disable-sequence-group-hopping* despite being enabled on a cell basis unless the PUSCH transmission corresponds to a Random Access Response Grant or a retransmission of the same transport block as part of the contention based random access procedure.

The group-hopping pattern $f_{gh}(n_s)$ may be different for PUSCH, PUCCH and SRS and is given by

$$f_{gh}(n_s) = \begin{cases} 0 & \text{if group hopping is disabled} \\ \left(\sum_{i=0}^7 c(8n_s + i) \cdot 2^i \right) \bmod 30 & \text{if group hopping is enabled} \end{cases}$$

where the pseudo-random sequence $c(i)$ is defined by section 7.2. The pseudo-random sequence generator shall be

initialized with $c_{init} = \left\lfloor \frac{n_{ID}^{RS}}{30} \right\rfloor$ at the beginning of each radio frame where n_{ID}^{RS} is given by Section 5.5.1.5.

The sequence-shift pattern f_{ss} definition differs between PUCCH, PUSCH and SRS.

For PUCCH, the sequence-shift pattern f_{ss}^{PUCCH} is given by $f_{ss}^{\text{PUCCH}} = n_{\text{ID}}^{\text{RS}} \bmod 30$ where $n_{\text{ID}}^{\text{RS}}$ is given by Section 5.5.1.5.

For PUSCH, the sequence-shift pattern f_{ss}^{PUSCH} is given by $f_{ss}^{\text{PUSCH}} = (N_{\text{ID}}^{\text{cell}} + \Delta_{\text{ss}}) \bmod 30$, where $\Delta_{\text{ss}} \in \{0,1,\dots,29\}$ is configured by higher layers, if no value for $n_{\text{ID}}^{\text{PUSCH}}$ is provided by higher layers or if the PUSCH transmission corresponds to a Random Access Response Grant or a retransmission of the same transport block as part of the contention based random access procedure, otherwise it is given by $f_{ss}^{\text{PUSCH}} = n_{\text{ID}}^{\text{RS}} \bmod 30$ with $n_{\text{ID}}^{\text{RS}}$ given by Section 5.5.1.5.

For SRS, the sequence-shift pattern f_{ss}^{SRS} is given by $f_{ss}^{\text{SRS}} = n_{\text{ID}}^{\text{RS}} \bmod 30$ where $n_{\text{ID}}^{\text{RS}}$ is given by Section 5.5.1.5.

5.5.1.4 Sequence hopping

Sequence hopping only applies for reference-signals of length $M_{\text{sc}}^{\text{RS}} \geq 6N_{\text{sc}}^{\text{RB}}$.

For reference-signals of length $M_{\text{sc}}^{\text{RS}} < 6N_{\text{sc}}^{\text{RB}}$, the base sequence number v within the base sequence group is given by $v = 0$.

For reference-signals of length $M_{\text{sc}}^{\text{RS}} \geq 6N_{\text{sc}}^{\text{RB}}$, the base sequence number v within the base sequence group in slot n_s is defined by

$$v = \begin{cases} c(n_s) & \text{if group hopping is disabled and sequence hopping is enabled} \\ 0 & \text{otherwise} \end{cases}$$

where the pseudo-random sequence $c(i)$ is given by section 7.2. The parameter *Sequence-hopping-enabled* provided by higher layers determines if sequence hopping is enabled or not. Sequence hopping for PUSCH can be disabled for a certain UE through the higher-layer parameter *Disable-sequence-group-hopping* despite being enabled on a cell basis unless the PUSCH transmission corresponds to a Random Access Response Grant or a retransmission of the same transport block as part of the contention based random access procedure.

For PUSCH, the pseudo-random sequence generator shall be initialized with $c_{\text{init}} = \left\lfloor \frac{n_{\text{ID}}^{\text{RS}}}{30} \right\rfloor \cdot 2^5 + f_{ss}^{\text{PUSCH}}$ at the

beginning of each radio frame where $n_{\text{ID}}^{\text{RS}}$ is given by Section 5.5.1.5.

For SRS, the pseudo-random sequence generator shall be initialized with $c_{\text{init}} = \left\lfloor \frac{n_{\text{ID}}^{\text{RS}}}{30} \right\rfloor \cdot 2^5 + (n_{\text{ID}}^{\text{RS}} + \Delta_{\text{ss}}) \bmod 30$ at the

beginning of each radio frame where $n_{\text{ID}}^{\text{RS}}$ is given by Section 5.5.1.5 and Δ_{ss} is given by Section 5.5.1.3.

5.5.1.5 Determining virtual cell identity for sequence generation

The definition of $n_{\text{ID}}^{\text{RS}}$ depends on the type of transmission.

Transmissions associated with PUSCH:

- $n_{\text{ID}}^{\text{RS}} = N_{\text{ID}}^{\text{cell}}$ if no value for $n_{\text{ID}}^{\text{PUSCH}}$ is configured by higher layers or if the PUSCH transmission corresponds to a Random Access Response Grant or a retransmission of the same transport block as part of the contention based random access procedure,
- $n_{\text{ID}}^{\text{RS}} = n_{\text{ID}}^{\text{PUSCH}}$ otherwise.

Transmissions associated with PUCCH:

- $n_{\text{ID}}^{\text{RS}} = N_{\text{ID}}^{\text{cell}}$ if no value for $n_{\text{ID}}^{\text{PUCCH}}$ is configured by higher layers,

- $n_{ID}^{RS} = n_{ID}^{PUCCH}$ otherwise.

Sounding reference signals:

- $n_{ID}^{RS} = N_{ID}^{cell}$.

5.5.2 Demodulation reference signal

5.5.2.1 Demodulation reference signal for PUSCH

5.5.2.1.1 Reference signal sequence

The PUSCH demodulation reference signal sequence $r_{PUSCH}^{(\lambda)}(\cdot)$ associated with layer $\lambda \in \{0, 1, \dots, v-1\}$ is defined by

$$r_{PUSCH}^{(\lambda)}(m \cdot M_{sc}^{RS} + n) = w^{(\lambda)}(m) r_{u,v}^{(\alpha_\lambda)}(n)$$

where

$$\begin{aligned} m &= 0, 1 \\ n &= 0, \dots, M_{sc}^{RS} - 1 \end{aligned}$$

and

$$M_{sc}^{RS} = M_{sc}^{PUSCH}$$

Section 5.5.1 defines the sequence $r_{u,v}^{(\alpha_\lambda)}(0), \dots, r_{u,v}^{(\alpha_\lambda)}(M_{sc}^{RS} - 1)$. The orthogonal sequence $w^{(\lambda)}(m)$ is given by

$\begin{bmatrix} w^{(\lambda)}(0) & w^{(\lambda)}(1) \end{bmatrix} = \begin{bmatrix} 1 & 1 \end{bmatrix}$ for DCI format 0 if the higher-layer parameter *Activate-DMRS-with OCC* is not set or if the temporary C-RNTI was used to transmit the most recent uplink-related DCI for the transport block associated with the corresponding PUSCH transmission, otherwise it is given by Table 5.5.2.1.1-1 using the cyclic shift field in most recent uplink-related DCI [3] for the transport block associated with the corresponding PUSCH transmission.

The cyclic shift α_λ in a slot n_s is given as $\alpha_\lambda = 2\pi n_{cs,\lambda}/12$ with

$$n_{cs,\lambda} = (n_{DMRS}^{(1)} + n_{DMRS,\lambda}^{(2)} + n_{PN}(n_s)) \bmod 12$$

where the values of $n_{DMRS}^{(1)}$ is given by Table 5.5.2.1.1-2 according to the parameter *cyclicShift* provided by higher layers, $n_{DMRS,\lambda}^{(2)}$ is given by the cyclic shift for DMRS field in most recent uplink-related DCI [3] for the transport block associated with the corresponding PUSCH transmission where the value of $n_{DMRS,\lambda}^{(2)}$ is given in Table 5.5.2.1.1-1.

The first row of Table 5.5.2.1.1-1 shall be used to obtain $n_{DMRS,0}^{(2)}$ and $w^{(\lambda)}(m)$ if there is no uplink-related DCI for the same transport block associated with the corresponding PUSCH transmission, and

- if the initial PUSCH for the same transport block is semi-persistently scheduled, or
- if the initial PUSCH for the same transport block is scheduled by the random access response grant.

The quantity $n_{PN}(n_s)$ is given by

$$n_{PN}(n_s) = \sum_{i=0}^7 c(8N_{symb}^{UL} \cdot n_s + i) \cdot 2^i$$

where the pseudo-random sequence $c(i)$ is defined by section 7.2. The application of $c(i)$ is cell-specific. The pseudo-random sequence generator shall be initialized with c_{init} at the beginning of each radio frame. The quantity c_{init} is

given by $c_{\text{init}} = \left\lfloor \frac{N_{\text{ID}}^{\text{cell}}}{30} \right\rfloor \cdot 2^5 + \left((N_{\text{ID}}^{\text{cell}} + \Delta_{\text{ss}}) \bmod 30 \right)$ if no value for $N_{\text{ID}}^{\text{csh_DMRS}}$ is configured by higher layers or the

PUSCH transmission corresponds to a Random Access Response Grant or a retransmission of the same transport block as part of the contention based random access procedure, otherwise it is given by

$$c_{\text{init}} = \left\lfloor \frac{N_{\text{ID}}^{\text{csh_DMRS}}}{30} \right\rfloor \cdot 2^5 + \left(N_{\text{ID}}^{\text{csh_DMRS}} \bmod 30 \right).$$

The vector of reference signals shall be precoded according to

$$\begin{bmatrix} \tilde{r}_{\text{PUSCH}}^{(0)} \\ \vdots \\ \tilde{r}_{\text{PUSCH}}^{(P-1)} \end{bmatrix} = W \begin{bmatrix} r_{\text{PUSCH}}^{(0)} \\ \vdots \\ r_{\text{PUSCH}}^{(v-1)} \end{bmatrix}$$

where P is the number of antenna ports used for PUSCH transmission.

For PUSCH transmission using a single antenna port, $P = 1$, $W = 1$ and $v = 1$.

For spatial multiplexing, $P = 2$ or $P = 4$ and the precoding matrix W shall be identical to the precoding matrix used in Section 5.3.3A.2 for precoding of the PUSCH in the same subframe.

Table 5.5.2.1.1-1: Mapping of Cyclic Shift Field in uplink-related DCI format to $n_{\text{DMRS},\lambda}^{(2)}$ and

$$\left[w^{(\lambda)}(0) \quad w^{(\lambda)}(1) \right].$$

Cyclic Shift Field in uplink-related DCI format [3]	$n_{\text{DMRS},\lambda}^{(2)}$				$\left[w^{(\lambda)}(0) \quad w^{(\lambda)}(1) \right]$			
	$\lambda = 0$	$\lambda = 1$	$\lambda = 2$	$\lambda = 3$	$\lambda = 0$	$\lambda = 1$	$\lambda = 2$	$\lambda = 3$
000	0	6	3	9	[1 1]	[1 1]	[1 -1]	[1 -1]
001	6	0	9	3	[1 -1]	[1 -1]	[1 1]	[1 1]
010	3	9	6	0	[1 -1]	[1 -1]	[1 1]	[1 1]
011	4	10	7	1	[1 1]	[1 1]	[1 1]	[1 1]
100	2	8	5	11	[1 1]	[1 1]	[1 1]	[1 1]
101	8	2	11	5	[1 -1]	[1 -1]	[1 -1]	[1 -1]
110	10	4	1	7	[1 -1]	[1 -1]	[1 -1]	[1 -1]
111	9	3	0	6	[1 1]	[1 1]	[1 -1]	[1 -1]

Table 5.5.2.1.1-2: Mapping of *cyclicShift* to $n_{\text{DMRS}}^{(1)}$ values.

cyclicShift	$n_{\text{DMRS}}^{(1)}$
0	0
1	2
2	3
3	4
4	6
5	8
6	9
7	10

5.5.2.1.2 Mapping to physical resources

For each antenna port used for transmission of the PUSCH, the sequence $\tilde{r}_{\text{PUSCH}}^{(\tilde{p})}(\cdot)$ shall be multiplied with the amplitude scaling factor β_{PUSCH} and mapped in sequence starting with $\tilde{r}_{\text{PUSCH}}^{(\tilde{p})}(0)$ to the resource blocks. The set of physical resource blocks used in the mapping process and the relation between the index \tilde{p} and the antenna port number p shall be identical to the corresponding PUSCH transmission as defined in Section 5.3.4. The mapping to resource elements (k, l) , with $l = 3$ for normal cyclic prefix and $l = 2$ for extended cyclic prefix, in the subframe shall be in increasing order of first k , then the slot number.

5.5.2.2 Demodulation reference signal for PUCCH

5.5.2.2.1 Reference signal sequence

The PUCCH demodulation reference signal sequence $r_{\text{PUCCH}}^{(\tilde{p})}(\cdot)$ is defined by

$$r_{\text{PUCCH}}^{(\tilde{p})}(m'N_{\text{RS}}^{\text{PUCCH}}M_{\text{sc}}^{\text{RS}} + mM_{\text{sc}}^{\text{RS}} + n) = \frac{1}{\sqrt{P}} \bar{w}^{(\tilde{p})}(m) z(m) r_{u,v}^{(\alpha_{\tilde{p}})}(n)$$

where

$$\begin{aligned} m &= 0, \dots, N_{\text{RS}}^{\text{PUCCH}} - 1 \\ n &= 0, \dots, M_{\text{sc}}^{\text{RS}} - 1 \\ m' &= 0, 1 \end{aligned}$$

and P is the number of antenna ports used for PUCCH transmission. For PUCCH formats 2a and 2b, $z(m)$ equals $d(10)$ for $m = 1$, where $d(10)$ is defined in Section 5.4.2. For all other cases, $z(m) = 1$.

The sequence $r_{u,v}^{(\alpha_{\tilde{p}})}(n)$ is given by Section 5.5.1 with $M_{\text{sc}}^{\text{RS}} = 12$ where the expression for the cyclic shift $\alpha_{\tilde{p}}$ is determined by the PUCCH format.

For PUCCH formats 1, 1a and 1b, $\alpha_{\tilde{p}}(n_s, l)$ is given by

$$\begin{aligned} \bar{n}_{\text{oc}}^{(\tilde{p})}(n_s) &= \left\lfloor n'_{\tilde{p}}(n_s) \cdot \Delta_{\text{shift}}^{\text{PUCCH}} / N' \right\rfloor \\ \alpha_{\tilde{p}}(n_s, l) &= 2\pi \cdot \bar{n}_{\text{cs}}^{(\tilde{p})}(n_s, l) / N_{\text{sc}}^{\text{RB}} \\ \bar{n}_{\text{cs}}^{(\tilde{p})}(n_s, l) &= \begin{cases} \left[n_{\text{cs}}^{\text{cell}}(n_s, l) + \left(n'_{\tilde{p}}(n_s) \cdot \Delta_{\text{shift}}^{\text{PUCCH}} + \left(\bar{n}_{\text{oc}}^{(\tilde{p})}(n_s) \bmod \Delta_{\text{shift}}^{\text{PUCCH}} \right) \right) \bmod N' \right] \bmod N_{\text{sc}}^{\text{RB}} & \text{for normal cyclic prefix} \\ \left[n_{\text{cs}}^{\text{cell}}(n_s, l) + \left(n'_{\tilde{p}}(n_s) \cdot \Delta_{\text{shift}}^{\text{PUCCH}} + \bar{n}_{\text{oc}}^{(\tilde{p})}(n_s) \right) \bmod N' \right] \bmod N_{\text{sc}}^{\text{RB}} & \text{for extended cyclic prefix} \end{cases} \end{aligned}$$

where $n'_{\tilde{p}}(n_s)$, N' , $\Delta_{\text{shift}}^{\text{PUCCH}}$ and $n_{\text{cs}}^{\text{cell}}(n_s, l)$ are defined by Section 5.4.1. The number of reference symbols per slot $N_{\text{RS}}^{\text{PUCCH}}$ and the sequence $\bar{w}(n)$ are given by Table 5.5.2.2.1-1 and 5.5.2.2.1-2, respectively.

For PUCCH formats 2, 2a and 2b, $\alpha_{\tilde{p}}(n_s, l)$ is defined by Section 5.4.2. The number of reference symbols per slot $N_{\text{RS}}^{\text{PUCCH}}$ and the sequence $\bar{w}^{(\tilde{p})}(n)$ are given by Table 5.5.2.2.1-1 and 5.5.2.2.1-3, respectively.

For PUCCH format 3, $\alpha_{\tilde{p}}(n_s, l)$ is given by

$$\begin{aligned} \alpha_{\tilde{p}}(n_s, l) &= 2\pi \cdot n_{\text{cs}}^{(\tilde{p})}(n_s, l) / N_{\text{sc}}^{\text{RB}} \\ n_{\text{cs}}^{(\tilde{p})}(n_s, l) &= \left(n_{\text{cs}}^{\text{cell}}(n_s, l) + n'_{\tilde{p}}(n_s) \right) \bmod N_{\text{sc}}^{\text{RB}} \end{aligned}$$

where $n'_p(n_s)$ is given by Table 5.5.2.2.1-4 and $n_{oc,0}^{(\tilde{p})}$ and $n_{oc,1}^{(\tilde{p})}$ for the first and second slot in a subframe, respectively, are obtained from Section 5.4.2A. The number of reference symbols per slot N_{RS}^{PUCCH} and the sequence $\bar{w}(n)$ are given by Table 5.5.2.2.1-1 and 5.5.2.2.1-3, respectively.

Table 5.5.2.2.1-1: Number of PUCCH demodulation reference symbols per slot N_{RS}^{PUCCH} .

PUCCH format	Normal cyclic prefix	Extended cyclic prefix
1, 1a, 1b	3	2
2, 3	2	1
2a, 2b	2	N/A

Table 5.5.2.2.1-2: Orthogonal sequences $[\bar{w}^{(\tilde{p})}(0) \dots \bar{w}^{(\tilde{p})}(N_{RS}^{PUCCH} - 1)]$ for PUCCH formats 1, 1a and 1b.

Sequence index $\bar{n}_{oc}^{(\tilde{p})}(n_s)$	Normal cyclic prefix	Extended cyclic prefix
0	[1 1 1]	[1 1]
1	[1 $e^{j2\pi/3}$ $e^{j4\pi/3}$]	[1 -1]
2	[1 $e^{j4\pi/3}$ $e^{j2\pi/3}$]	N/A

Table 5.5.2.2.1-3: Orthogonal sequences $[\bar{w}^{(\tilde{p})}(0) \dots \bar{w}^{(\tilde{p})}(N_{RS}^{PUCCH} - 1)]$ for PUCCH formats 2, 2a, 2b and 3.

Normal cyclic prefix	Extended cyclic prefix
[1 1]	[1]

Table 5.5.2.2.1-4: Relation between $n_{oc}^{(\tilde{p})}$ and $n'_p(n_s)$ for PUCCH format 3.

$n_{oc}^{(\tilde{p})}$	$n'_p(n_s)$	
	$N_{SF,1} = 5$	$N_{SF,1} = 4$
0	0	0
1	3	3
2	6	6
3	8	9
4	10	N/A

5.5.2.2.2 Mapping to physical resources

The sequence $r_{PUCCH}^{(\tilde{p})}(\cdot)$ shall be multiplied with the amplitude scaling factor β_{PUCCH} and mapped in sequence starting with $r_{PUCCH}^{(\tilde{p})}(0)$ to resource elements (k, l) on antenna port p . The mapping shall be in increasing order of first k , then l and finally the slot number. The set of values for k and the relation between the index \tilde{p} and the antenna port number p shall be identical to the values used for the corresponding PUCCH transmission. The values of the symbol index l in a slot are given by Table 5.5.2.2.2-1.

Table 5.5.2.2-1: Demodulation reference signal location for different PUCCH formats.

PUCCH format	Set of values for l	
	Normal cyclic prefix	Extended cyclic prefix
1, 1a, 1b	2, 3, 4	2, 3
2, 3	1, 5	3
2a, 2b	1, 5	N/A

5.5.3 Sounding reference signal

5.5.3.1 Sequence generation

The sounding reference signal sequence $r_{\text{SRS}}^{(\tilde{p})}(n) = r_{u,v}^{(\alpha_{\tilde{p}})}(n)$ is defined by Section 5.5.1, where u is the sequence-group number defined in Section 5.5.1.3 and v is the base sequence number defined in Section 5.5.1.4. The cyclic shift $\alpha_{\tilde{p}}$ of the sounding reference signal is given as

$$\alpha_{\tilde{p}} = 2\pi \frac{n_{\text{SRS}}^{\text{cs},\tilde{p}}}{8}$$

$$n_{\text{SRS}}^{\text{cs},\tilde{p}} = \left(n_{\text{SRS}}^{\text{cs}} + \frac{8\tilde{p}}{N_{\text{ap}}} \right) \bmod 8,$$

$$\tilde{p} \in \{0, 1, \dots, N_{\text{ap}} - 1\}$$

where $n_{\text{SRS}}^{\text{cs}} = \{0, 1, 2, 3, 4, 5, 6, 7\}$ is configured separately for periodic and each configuration of aperiodic sounding by the higher-layer parameters *cyclicShift* and *cyclicShift-ap*, respectively, for each UE and N_{ap} is the number of antenna ports used for sounding reference signal transmission.

5.5.3.2 Mapping to physical resources

The sequence shall be multiplied with the amplitude scaling factor β_{SRS} in order to conform to the transmit power P_{SRS} specified in Section 5.1.3.1 in [4], and mapped in sequence starting with $r_{\text{SRS}}^{(\tilde{p})}(0)$ to resource elements (k, l) on antenna port p according to

$$a_{2k'+k_0^{(p)},l}^{(p)} = \begin{cases} \frac{1}{\sqrt{N_{\text{ap}}}} \beta_{\text{SRS}} r_{\text{SRS}}^{(\tilde{p})}(k') & k' = 0, 1, \dots, M_{\text{sc},b}^{\text{RS}} - 1 \\ 0 & \text{otherwise} \end{cases}$$

where N_{ap} is the number of antenna ports used for sounding reference signal transmission and the relation between the index \tilde{p} and the antenna port p is given by Table 5.2.1-1. The set of antenna ports used for sounding reference signal transmission is configured independently for periodic and each configuration of aperiodic sounding. The quantity $k_0^{(p)}$ is the frequency-domain starting position of the sounding reference signal and for $b = B_{\text{SRS}}$ and $M_{\text{sc},b}^{\text{RS}}$ is the length of the sounding reference signal sequence defined as

$$M_{\text{sc},b}^{\text{RS}} = m_{\text{SRS},b} N_{\text{sc}}^{\text{RB}} / 2$$

where $m_{\text{SRS},b}$ is given by Table 5.5.3.2-1 through Table 5.5.3.2-4 for each uplink bandwidth $N_{\text{RB}}^{\text{UL}}$. The cell-specific parameter *srs-BandwidthConfig*, $C_{\text{SRS}} \in \{0, 1, 2, 3, 4, 5, 6, 7\}$ and the UE-specific parameter *srs-Bandwidth*, $B_{\text{SRS}} \in \{0, 1, 2, 3\}$ are given by higher layers. For UpPTS, $m_{\text{SRS},0}$ shall be reconfigured to $m_{\text{SRS},0}^{\text{max}} = \max_{c \in C} \{m_{\text{SRS},0}^c\} \leq (N_{\text{RB}}^{\text{UL}} - 6N_{\text{RA}})$ if this reconfiguration is enabled by the cell-specific parameter *srsMaxUpPts* given by higher layers, otherwise if the reconfiguration is disabled $m_{\text{SRS},0}^{\text{max}} = m_{\text{SRS},0}$, where c is a SRS BW configuration and C_{SRS} is the set of SRS BW

configurations from the Tables 5.5.3.2-1 to 5.5.3.2-4 for each uplink bandwidth N_{RB}^{UL} , N_{RA} is the number of format 4 PRACH in the addressed UpPTS and derived from Table 5.7.1-4.

The frequency-domain starting position $k_0^{(p)}$ is defined by

$$k_0^{(p)} = \bar{k}_0^{(p)} + \sum_{b=0}^{B_{SRS}} 2M_{sc,b}^{RS} n_b$$

where for normal uplink subframes $\bar{k}_0^{(p)}$ is defined by

$$\bar{k}_0^{(p)} = \left(\lfloor N_{RB}^{UL} / 2 \rfloor - m_{SRS,0} \right) N_{SC}^{RB} + k_{TC}^{(p)}$$

and for UpPTS by

$$\bar{k}_0^{(p)} = \begin{cases} (N_{RB}^{UL} - m_{SRS,0}^{\max}) N_{SC}^{RB} + k_{TC}^{(p)} & \text{if } ((n_f \bmod 2) \cdot (2 - N_{SP}) + n_{hf}) \bmod 2 = 0 \\ k_{TC}^{(p)} & \text{otherwise} \end{cases}$$

The quantity $k_{TC}^{(p)} \in \{0,1\}$ is given by

$$k_{TC}^{(p)} = \begin{cases} 1 - \bar{k}_{TC} & \text{if } n_{SRS}^{cs} \in \{4,5,6,7\} \text{ and } \tilde{p} \in \{1,3\} \text{ and } N_{ap} = 4 \\ \bar{k}_{TC} & \text{otherwise} \end{cases}$$

where the relation between the index \tilde{p} and the antenna port p is given by Table 5.2.1-1, $\bar{k}_{TC} \in \{0,1\}$ is given by the UE-specific parameter *transmissionComb* or *transmissionComb-ap* for periodic and each configuration of aperiodic transmission, respectively, provided by higher layers for the UE, and n_b is frequency position index. The variable n_{hf} is equal to 0 for UpPTS in the first half frame and equal to 1 for UpPTS in the second half frame of a radio frame.

The frequency hopping of the sounding reference signal is configured by the parameter $b_{hop} \in \{0,1,2,3\}$, provided by higher-layer parameter *srs-HoppingBandwidth*. Frequency hopping is not supported for aperiodic transmission.. If frequency hopping of the sounding reference signal is not enabled (i.e., $b_{hop} \geq B_{SRS}$), the frequency position index n_b remains constant (unless re-configured) and is defined by $n_b = \lfloor 4n_{RRC} / m_{SRS,b} \rfloor \bmod N_b$ where the parameter n_{RRC} is given by higher-layer parameters *freqDomainPosition* and *freqDomainPosition-ap* for periodic and each configuration of aperiodic transmission, respectively. If frequency hopping of the sounding reference signal is enabled (i.e., $b_{hop} < B_{SRS}$), the frequency position indexes n_b are defined by

$$n_b = \begin{cases} \lfloor 4n_{RRC} / m_{SRS,b} \rfloor \bmod N_b & b \leq b_{hop} \\ \{F_b(n_{SRS}) + \lfloor 4n_{RRC} / m_{SRS,b} \rfloor\} \bmod N_b & \text{otherwise} \end{cases}$$

where N_b is given by Table 5.5.3.2-1 through Table 5.5.3.2-4 for each uplink bandwidth N_{RB}^{UL} ,

$$F_b(n_{SRS}) = \begin{cases} (N_b / 2) \left[\frac{n_{SRS} \bmod \prod_{b'=b_{hop}}^b N_{b'}}{\prod_{b'=b_{hop}}^{b-1} N_{b'}} \right] + \left[\frac{n_{SRS} \bmod \prod_{b'=b_{hop}}^b N_{b'}}{2 \prod_{b'=b_{hop}}^{b-1} N_{b'}} \right] & \text{if } N_b \text{ even} \\ \lfloor N_b / 2 \rfloor \lfloor n_{SRS} / \prod_{b'=b_{hop}}^{b-1} N_{b'} \rfloor & \text{if } N_b \text{ odd} \end{cases}$$

where $N_{b_{hop}} = 1$ regardless of the N_b value on Table 5.5.3.2-1 through Table 5.5.3.2-4, and

$$n_{SRS} = \begin{cases} 2N_{SP}n_f + 2(N_{SP} - 1) \left\lfloor \frac{n_s}{10} \right\rfloor + \left\lfloor \frac{T_{offset}}{T_{offset_max}} \right\rfloor, & \text{for 2 ms SRS periodicity of frame structure type 2} \\ \lfloor (n_f \times 10 + \lfloor n_s / 2 \rfloor) / T_{SRS} \rfloor & \text{otherwise} \end{cases}$$

counts the number of UE-specific SRS transmissions, where T_{SRS} is UE-specific periodicity of SRS transmission defined in section 8.2 of [4], T_{offset} is SRS subframe offset defined in Table 8.2-2 of [4] and $T_{\text{offset_max}}$ is the maximum value of T_{offset} for a certain configuration of SRS subframe offset.

For all subframes other than special subframes, the sounding reference signal shall be transmitted in the last symbol of the subframe.

Table 5.5.3.2-1: $m_{\text{SRS},b}$ and N_b , $b = 0,1,2,3$, values for the uplink bandwidth of $6 \leq N_{\text{RB}}^{\text{UL}} \leq 40$.

SRS bandwidth configuration C_{SRS}	SRS-Bandwidth $B_{\text{SRS}} = 0$		SRS-Bandwidth $B_{\text{SRS}} = 1$		SRS-Bandwidth $B_{\text{SRS}} = 2$		SRS-Bandwidth $B_{\text{SRS}} = 3$	
	$m_{\text{SRS},0}$	N_0	$m_{\text{SRS},1}$	N_1	$m_{\text{SRS},2}$	N_2	$m_{\text{SRS},3}$	N_3
0	36	1	12	3	4	3	4	1
1	32	1	16	2	8	2	4	2
2	24	1	4	6	4	1	4	1
3	20	1	4	5	4	1	4	1
4	16	1	4	4	4	1	4	1
5	12	1	4	3	4	1	4	1
6	8	1	4	2	4	1	4	1
7	4	1	4	1	4	1	4	1

Table 5.5.3.2-2: $m_{\text{SRS},b}$ and N_b , $b = 0,1,2,3$, values for the uplink bandwidth of $40 < N_{\text{RB}}^{\text{UL}} \leq 60$.

SRS bandwidth configuration C_{SRS}	SRS-Bandwidth $B_{\text{SRS}} = 0$		SRS-Bandwidth $B_{\text{SRS}} = 1$		SRS-Bandwidth $B_{\text{SRS}} = 2$		SRS-Bandwidth $B_{\text{SRS}} = 3$	
	$m_{\text{SRS},0}$	N_0	$m_{\text{SRS},1}$	N_1	$m_{\text{SRS},2}$	N_2	$m_{\text{SRS},3}$	N_3
0	48	1	24	2	12	2	4	3
1	48	1	16	3	8	2	4	2
2	40	1	20	2	4	5	4	1
3	36	1	12	3	4	3	4	1
4	32	1	16	2	8	2	4	2
5	24	1	4	6	4	1	4	1
6	20	1	4	5	4	1	4	1
7	16	1	4	4	4	1	4	1

Table 5.5.3.2-3: $m_{\text{SRS},b}$ and N_b , $b = 0,1,2,3$, values for the uplink bandwidth of $60 < N_{\text{RB}}^{\text{UL}} \leq 80$.

SRS bandwidth configuration C_{SRS}	SRS-Bandwidth $B_{\text{SRS}} = 0$		SRS-Bandwidth $B_{\text{SRS}} = 1$		SRS-Bandwidth $B_{\text{SRS}} = 2$		SRS-Bandwidth $B_{\text{SRS}} = 3$	
	$m_{\text{SRS},0}$	N_0	$m_{\text{SRS},1}$	N_1	$m_{\text{SRS},2}$	N_2	$m_{\text{SRS},3}$	N_3
0	72	1	24	3	12	2	4	3
1	64	1	32	2	16	2	4	4
2	60	1	20	3	4	5	4	1
3	48	1	24	2	12	2	4	3
4	48	1	16	3	8	2	4	2
5	40	1	20	2	4	5	4	1
6	36	1	12	3	4	3	4	1
7	32	1	16	2	8	2	4	2

Table 5.5.3.2-4: $m_{\text{SRS},b}$ and N_b , $b = 0,1,2,3$, values for the uplink bandwidth of $80 < N_{\text{RB}}^{\text{UL}} \leq 110$.

SRS bandwidth configuration C_{SRS}	SRS-Bandwidth $B_{\text{SRS}} = 0$		SRS-Bandwidth $B_{\text{SRS}} = 1$		SRS-Bandwidth $B_{\text{SRS}} = 2$		SRS-Bandwidth $B_{\text{SRS}} = 3$	
	$m_{\text{SRS},0}$	N_0	$m_{\text{SRS},1}$	N_1	$m_{\text{SRS},2}$	N_2	$m_{\text{SRS},3}$	N_3
0	96	1	48	2	24	2	4	6
1	96	1	32	3	16	2	4	4
2	80	1	40	2	20	2	4	5
3	72	1	24	3	12	2	4	3
4	64	1	32	2	16	2	4	4
5	60	1	20	3	4	5	4	1
6	48	1	24	2	12	2	4	3
7	48	1	16	3	8	2	4	2

5.5.3.3 Sounding reference signal subframe configuration

The cell-specific subframe configuration period T_{SFC} and the cell-specific subframe offset Δ_{SFC} for the transmission of sounding reference signals are listed in Tables 5.5.3.3-1 and 5.5.3.3-2, for frame structures type 1 and 2 respectively, where the parameter *srs-SubframeConfig* is provided by higher layers. Sounding reference signal subframes are the subframes satisfying $\lfloor n_s / 2 \rfloor \bmod T_{\text{SFC}} \in \Delta_{\text{SFC}}$. For frame structure type 2, sounding reference signal is transmitted only in configured UL subframes or UpPTS.

Table 5.5.3.3-1: Frame structure type 1 sounding reference signal subframe configuration.

srs-SubframeConfig	Binary	Configuration Period T_{SFC} (subframes)	Transmission offset Δ_{SFC} (subframes)
0	0000	1	{0}
1	0001	2	{0}
2	0010	2	{1}
3	0011	5	{0}
4	0100	5	{1}
5	0101	5	{2}
6	0110	5	{3}
7	0111	5	{0,1}
8	1000	5	{2,3}
9	1001	10	{0}
10	1010	10	{1}
11	1011	10	{2}
12	1100	10	{3}
13	1101	10	{0,1,2,3,4,6,8}
14	1110	10	{0,1,2,3,4,5,6,8}
15	1111	reserved	reserved

Table 5.5.3.3-2: Frame structure type 2 sounding reference signal subframe configuration.

srs-SubframeConfig	Binary	Configuration Period T_{SFC} (subframes)	Transmission offset Δ_{SFC} (subframes)
0	0000	5	{1}
1	0001	5	{1, 2}
2	0010	5	{1, 3}
3	0011	5	{1, 4}
4	0100	5	{1, 2, 3}
5	0101	5	{1, 2, 4}
6	0110	5	{1, 3, 4}
7	0111	5	{1, 2, 3, 4}
8	1000	10	{1, 2, 6}
9	1001	10	{1, 3, 6}
10	1010	10	{1, 6, 7}
11	1011	10	{1, 2, 6, 8}
12	1100	10	{1, 3, 6, 9}
13	1101	10	{1, 4, 6, 7}
14	1110	reserved	reserved
15	1111	reserved	reserved

5.6 SC-FDMA baseband signal generation

This section applies to all uplink physical signals and physical channels except the physical random access channel.

The time-continuous signal $s_l^{(p)}(t)$ for antenna port p in SC-FDMA symbol l in an uplink slot is defined by

$$s_l^{(p)}(t) = \sum_{k=-\lfloor N_{RB}^{UL} N_{sc}^{RB} / 2 \rfloor}^{\lfloor N_{RB}^{UL} N_{sc}^{RB} / 2 \rfloor - 1} a_{k^{(-)},l}^{(p)} \cdot e^{j2\pi(k+l/2)\Delta f(t - N_{CP,l}T_s)}$$

for $0 \leq t < (N_{CP,l} + N) \times T_s$ where $k^{(-)} = k + \lfloor N_{RB}^{UL} N_{sc}^{RB} / 2 \rfloor$, $N = 2048$, $\Delta f = 15$ kHz and $a_{k,l}^{(p)}$ is the content of resource element (k,l) on antenna port p .

The SC-FDMA symbols in a slot shall be transmitted in increasing order of l , starting with $l = 0$, where SC-FDMA symbol $l > 0$ starts at time $\sum_{l'=0}^{l-1} (N_{CP,l'} + N)T_s$ within the slot.

Table 5.6-1 lists the values of $N_{CP,l}$ that shall be used.

Table 5.6-1: SC-FDMA parameters.

Configuration	Cyclic prefix length $N_{CP,l}$
Normal cyclic prefix	160 for $l = 0$ 144 for $l = 1, 2, \dots, 6$
Extended cyclic prefix	512 for $l = 0, 1, \dots, 5$

5.7 Physical random access channel

5.7.1 Time and frequency structure

The physical layer random access preamble, illustrated in Figure 5.7.1-1, consists of a cyclic prefix of length T_{CP} and a sequence part of length T_{SEQ} . The parameter values are listed in Table 5.7.1-1 and depend on the frame structure and the random access configuration. Higher layers control the preamble format.

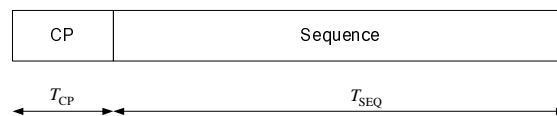

Figure 5.7.1-1: Random access preamble format.

Table 5.7.1-1: Random access preamble parameters.

Preamble format	T_{CP}	T_{SEQ}
0	$3168 \cdot T_s$	$24576 \cdot T_s$
1	$21024 \cdot T_s$	$24576 \cdot T_s$
2	$6240 \cdot T_s$	$2 \cdot 24576 \cdot T_s$
3	$21024 \cdot T_s$	$2 \cdot 24576 \cdot T_s$
4*	$448 \cdot T_s$	$4096 \cdot T_s$

* Frame structure type 2 and special subframe configurations with UpPTS lengths $4384 \cdot T_s$ and $5120 \cdot T_s$ only.

The transmission of a random access preamble, if triggered by the MAC layer, is restricted to certain time and frequency resources. These resources are enumerated in increasing order of the subframe number within the radio frame and the physical resource blocks in the frequency domain such that index 0 correspond to the lowest numbered physical resource block and subframe within the radio frame. PRACH resources within the radio frame are indicated by a PRACH Resource Index, where the indexing is in the order of appearance in Table 5.7.1-2 and Table 5.7.1-4.

For frame structure type 1 with preamble format 0-3, there is at most one random access resource per subframe. Table 5.7.1-2 lists the preamble formats according to Table 5.7.1-1 and the subframes in which random access preamble transmission is allowed for a given configuration in frame structure type 1. The parameter *prach-ConfigurationIndex* is given by higher layers. The start of the random access preamble shall be aligned with the start of the corresponding uplink subframe at the UE assuming $N_{TA} = 0$, where N_{TA} is defined in section 8.1. For PRACH configurations 0, 1, 2, 15, 16, 17, 18, 31, 32, 33, 34, 47, 48, 49, 50 and 63 the UE may for handover purposes assume an absolute value of the relative time difference between radio frame i in the current cell and the target cell of less than $153600 \cdot T_s$. The first physical resource block n_{PRB}^{RA} allocated to the PRACH opportunity considered for preamble formats 0, 1, 2 and 3 is defined as $n_{PRB}^{RA} = n_{PRB\text{offset}}^{RA}$, where the parameter *prach-FrequencyOffset*, $n_{PRB\text{offset}}^{RA}$ is expressed as a physical resource block number configured by higher layers and fulfilling $0 \leq n_{PRB\text{offset}}^{RA} \leq N_{RB}^{UL} - 6$.

Table 5.7.1-2: Frame structure type 1 random access configuration for preamble formats 0-3.

PRACH Configuration Index	Preamble Format	System frame number	Subframe number	PRACH Configuration Index	Preamble Format	System frame number	Subframe number
0	0	Even	1	32	2	Even	1
1	0	Even	4	33	2	Even	4
2	0	Even	7	34	2	Even	7
3	0	Any	1	35	2	Any	1
4	0	Any	4	36	2	Any	4
5	0	Any	7	37	2	Any	7
6	0	Any	1, 6	38	2	Any	1, 6
7	0	Any	2, 7	39	2	Any	2, 7
8	0	Any	3, 8	40	2	Any	3, 8
9	0	Any	1, 4, 7	41	2	Any	1, 4, 7
10	0	Any	2, 5, 8	42	2	Any	2, 5, 8
11	0	Any	3, 6, 9	43	2	Any	3, 6, 9
12	0	Any	0, 2, 4, 6, 8	44	2	Any	0, 2, 4, 6, 8
13	0	Any	1, 3, 5, 7, 9	45	2	Any	1, 3, 5, 7, 9
14	0	Any	0, 1, 2, 3, 4, 5, 6, 7, 8, 9	46	N/A	N/A	N/A
15	0	Even	9	47	2	Even	9
16	1	Even	1	48	3	Even	1
17	1	Even	4	49	3	Even	4
18	1	Even	7	50	3	Even	7
19	1	Any	1	51	3	Any	1
20	1	Any	4	52	3	Any	4
21	1	Any	7	53	3	Any	7
22	1	Any	1, 6	54	3	Any	1, 6
23	1	Any	2, 7	55	3	Any	2, 7
24	1	Any	3, 8	56	3	Any	3, 8
25	1	Any	1, 4, 7	57	3	Any	1, 4, 7
26	1	Any	2, 5, 8	58	3	Any	2, 5, 8
27	1	Any	3, 6, 9	59	3	Any	3, 6, 9
28	1	Any	0, 2, 4, 6, 8	60	N/A	N/A	N/A
29	1	Any	1, 3, 5, 7, 9	61	N/A	N/A	N/A
30	N/A	N/A	N/A	62	N/A	N/A	N/A
31	1	Even	9	63	3	Even	9

For frame structure type 2 with preamble formats 0-4, there might be multiple random access resources in an UL subframe (or UpPTS for preamble format 4) depending on the UL/DL configuration [see table 4.2-2]. Table 5.7.1-3 lists PRACH configurations allowed for frame structure type 2 where the configuration index corresponds to a certain combination of preamble format, PRACH density value, D_{RA} and version index, r_{RA} . The parameter *prach-ConfigurationIndex* is given by higher layers. For frame structure type 2 with PRACH configuration 0, 1, 2, 20, 21, 22, 30, 31, 32, 40, 41, 42, 48, 49, 50, or with PRACH configuration 51, 53, 54, 55, 56, 57 in UL/DL configuration 3, 4, 5, the UE may for handover purposes assume an absolute value of the relative time difference between radio frame i in the current cell and the target cell is less than $153600 \cdot T_s$.

Table 5.7.1-3: Frame structure type 2 random access configurations for preamble formats 0-4.

PRACH configuration Index	Preamble Format	Density Per 10 ms D_{RA}	Version r_{RA}	PRACH configuration Index	Preamble Format	Density Per 10 ms D_{RA}	Version r_{RA}
0	0	0.5	0	32	2	0.5	2
1	0	0.5	1	33	2	1	0
2	0	0.5	2	34	2	1	1
3	0	1	0	35	2	2	0
4	0	1	1	36	2	3	0
5	0	1	2	37	2	4	0
6	0	2	0	38	2	5	0
7	0	2	1	39	2	6	0
8	0	2	2	40	3	0.5	0
9	0	3	0	41	3	0.5	1
10	0	3	1	42	3	0.5	2
11	0	3	2	43	3	1	0
12	0	4	0	44	3	1	1
13	0	4	1	45	3	2	0
14	0	4	2	46	3	3	0
15	0	5	0	47	3	4	0
16	0	5	1	48	4	0.5	0
17	0	5	2	49	4	0.5	1
18	0	6	0	50	4	0.5	2
19	0	6	1	51	4	1	0
20	1	0.5	0	52	4	1	1
21	1	0.5	1	53	4	2	0
22	1	0.5	2	54	4	3	0
23	1	1	0	55	4	4	0
24	1	1	1	56	4	5	0
25	1	2	0	57	4	6	0
26	1	3	0	58	N/A	N/A	N/A
27	1	4	0	59	N/A	N/A	N/A
28	1	5	0	60	N/A	N/A	N/A
29	1	6	0	61	N/A	N/A	N/A
30	2	0.5	0	62	N/A	N/A	N/A
31	2	0.5	1	63	N/A	N/A	N/A

Table 5.7.1-4 lists the mapping to physical resources for the different random access opportunities needed for a certain PRACH density value, D_{RA} . Each quadruple of the format $(f_{RA}, t_{RA}^{(0)}, t_{RA}^{(1)}, t_{RA}^{(2)})$ indicates the location of a specific random access resource, where f_{RA} is a frequency resource index within the considered time instance, $t_{RA}^{(0)} = 0,1,2$ indicates whether the resource is reoccurring in all radio frames, in even radio frames, or in odd radio frames, respectively, $t_{RA}^{(1)} = 0,1$ indicates whether the random access resource is located in first half frame or in second half frame, respectively, and where $t_{RA}^{(2)}$ is the uplink subframe number where the preamble starts, counting from 0 at the first uplink subframe between 2 consecutive downlink-to-uplink switch points, with the exception of preamble format 4 where $t_{RA}^{(2)}$ is denoted as (*). The start of the random access preamble formats 0-3 shall be aligned with the start of the corresponding uplink subframe at the UE assuming $N_{TA} = 0$ and the random access preamble format 4 shall start $4832 \cdot T_s$ before the end of the UpPTS at the UE, where the UpPTS is referenced to the UE's uplink frame timing assuming $N_{TA} = 0$.

The random access opportunities for each PRACH configuration shall be allocated in time first and then in frequency if and only if time multiplexing is not sufficient to hold all opportunities of a PRACH configuration needed for a certain density value D_{RA} without overlap in time. For preamble format 0-3, the frequency multiplexing shall be done according to

$$n_{\text{PRB}}^{\text{RA}} = \begin{cases} n_{\text{PRB offset}}^{\text{RA}} + 6 \left\lfloor \frac{f_{\text{RA}}}{2} \right\rfloor, & \text{if } f_{\text{RA}} \bmod 2 = 0 \\ N_{\text{RB}}^{\text{UL}} - 6 - n_{\text{PRB offset}}^{\text{RA}} - 6 \left\lfloor \frac{f_{\text{RA}}}{2} \right\rfloor, & \text{otherwise} \end{cases}$$

where $N_{\text{RB}}^{\text{UL}}$ is the number of uplink resource blocks, $n_{\text{PRB}}^{\text{RA}}$ is the first physical resource block allocated to the PRACH opportunity considered and where the parameter *prach-FrequencyOffset*, $n_{\text{PRB offset}}^{\text{RA}}$ is the first physical resource block available for PRACH expressed as a physical resource block number configured by higher layers and fulfilling $0 \leq n_{\text{PRB offset}}^{\text{RA}} \leq N_{\text{RB}}^{\text{UL}} - 6$.

For preamble format 4, the frequency multiplexing shall be done according to

$$n_{\text{PRB}}^{\text{RA}} = \begin{cases} 6f_{\text{RA}}, & \text{if } ((n_f \bmod 2) \times (2 - N_{\text{SP}}) + t_{\text{RA}}^{(1)}) \bmod 2 = 0 \\ N_{\text{RB}}^{\text{UL}} - 6(f_{\text{RA}} + 1), & \text{otherwise} \end{cases}$$

where n_f is the system frame number and where N_{SP} is the number of DL to UL switch points within the radio frame.

Each random access preamble occupies a bandwidth corresponding to 6 consecutive resource blocks for both frame structures.

Table 5.7.1-4: Frame structure type 2 random access preamble mapping in time and frequency.

PRACH configuration Index (See Table 5.7.1-3)	UL/DL configuration (See Table 4.2-2)						
	0	1	2	3	4	5	6
0	(0,1,0,2)	(0,1,0,1)	(0,1,0,0)	(0,1,0,2)	(0,1,0,1)	(0,1,0,0)	(0,1,0,2)
1	(0,2,0,2)	(0,2,0,1)	(0,2,0,0)	(0,2,0,2)	(0,2,0,1)	(0,2,0,0)	(0,2,0,2)
2	(0,1,1,2)	(0,1,1,1)	(0,1,1,0)	(0,1,0,1)	(0,1,0,0)	N/A	(0,1,1,1)
3	(0,0,0,2)	(0,0,0,1)	(0,0,0,0)	(0,0,0,2)	(0,0,0,1)	(0,0,0,0)	(0,0,0,2)
4	(0,0,1,2)	(0,0,1,1)	(0,0,1,0)	(0,0,0,1)	(0,0,0,0)	N/A	(0,0,1,1)
5	(0,0,0,1)	(0,0,0,0)	N/A	(0,0,0,0)	N/A	N/A	(0,0,0,1)
6	(0,0,0,2)	(0,0,0,1)	(0,0,0,0)	(0,0,0,1)	(0,0,0,0)	(0,0,0,0)	(0,0,0,2)
	(0,0,1,2)	(0,0,1,1)	(0,0,1,0)	(0,0,0,2)	(0,0,0,1)	(1,0,0,0)	(0,0,1,1)
7	(0,0,0,1)	(0,0,0,0)	N/A	(0,0,0,0)	N/A	N/A	(0,0,0,1)
	(0,0,1,1)	(0,0,1,0)		(0,0,0,2)			(0,0,1,0)
8	(0,0,0,0)	N/A	N/A	(0,0,0,0)	N/A	N/A	(0,0,0,0)
	(0,0,1,0)			(0,0,0,1)			(0,0,1,1)
9	(0,0,0,1)	(0,0,0,0)	(0,0,0,0)	(0,0,0,0)	(0,0,0,0)	(0,0,0,0)	(0,0,0,1)
	(0,0,0,2)	(0,0,0,1)	(0,0,1,0)	(0,0,0,1)	(0,0,0,1)	(1,0,0,0)	(0,0,0,2)
	(0,0,1,2)	(0,0,1,1)	(1,0,0,0)	(0,0,0,2)	(1,0,0,1)	(2,0,0,0)	(0,0,1,1)
10	(0,0,0,0)	(0,0,0,1)	(0,0,0,0)	N/A	(0,0,0,0)	N/A	(0,0,0,0)
	(0,0,1,0)	(0,0,1,0)	(0,0,1,0)		(0,0,0,1)		(0,0,0,2)
	(0,0,1,1)	(0,0,1,1)	(1,0,1,0)		(1,0,0,0)		(0,0,1,0)
11	N/A	(0,0,0,0)	N/A	N/A	N/A	N/A	(0,0,0,1)
		(0,0,0,1)					(0,0,1,0)
		(0,0,1,0)					(0,0,1,1)
12	(0,0,0,1)	(0,0,0,0)	(0,0,0,0)	(0,0,0,0)	(0,0,0,0)	(0,0,0,0)	(0,0,0,1)
	(0,0,0,2)	(0,0,0,1)	(0,0,1,0)	(0,0,0,1)	(0,0,0,1)	(1,0,0,0)	(0,0,0,2)
	(0,0,1,1)	(0,0,1,0)	(1,0,0,0)	(0,0,0,2)	(1,0,0,0)	(2,0,0,0)	(0,0,1,0)
	(0,0,1,2)	(0,0,1,1)	(1,0,1,0)	(1,0,0,2)	(1,0,0,1)	(3,0,0,0)	(0,0,1,1)
13	(0,0,0,0)	N/A	N/A	(0,0,0,0)	N/A	N/A	(0,0,0,0)
	(0,0,0,2)			(0,0,0,1)			(0,0,0,1)
	(0,0,1,0)			(0,0,0,2)			(0,0,0,2)
	(0,0,1,2)			(1,0,0,1)			(0,0,1,1)
14	(0,0,0,0)	N/A	N/A	(0,0,0,0)	N/A	N/A	(0,0,0,0)
	(0,0,0,1)			(0,0,0,1)			(0,0,0,2)
	(0,0,1,0)			(0,0,0,2)			(0,0,1,0)
	(0,0,1,1)			(1,0,0,0)			(0,0,1,1)
15	(0,0,0,0)	(0,0,0,0)	(0,0,0,0)	(0,0,0,0)	(0,0,0,0)	(0,0,0,0)	(0,0,0,0)
	(0,0,0,1)	(0,0,0,1)	(0,0,1,0)	(0,0,0,1)	(0,0,0,1)	(1,0,0,0)	(0,0,0,1)
	(0,0,0,2)	(0,0,1,0)	(1,0,0,0)	(0,0,0,2)	(1,0,0,0)	(2,0,0,0)	(0,0,0,2)
	(0,0,1,1)	(0,0,1,1)	(1,0,1,0)	(1,0,0,1)	(1,0,0,1)	(3,0,0,0)	(0,0,1,0)
	(0,0,1,2)	(1,0,0,1)	(2,0,0,0)	(1,0,0,2)	(2,0,0,1)	(4,0,0,0)	(0,0,1,1)
16	(0,0,0,1)	(0,0,0,0)	(0,0,0,0)	(0,0,0,0)	(0,0,0,0)	N/A	N/A
	(0,0,0,2)	(0,0,0,1)	(0,0,1,0)	(0,0,0,1)	(0,0,0,1)		
	(0,0,1,0)	(0,0,1,0)	(1,0,0,0)	(0,0,0,2)	(1,0,0,0)		
	(0,0,1,1)	(0,0,1,1)	(1,0,1,0)	(1,0,0,0)	(1,0,0,1)		
	(0,0,1,2)	(1,0,1,1)	(2,0,1,0)	(1,0,0,2)	(2,0,0,0)		
17	(0,0,0,0)	(0,0,0,0)	N/A	(0,0,0,0)	N/A	N/A	N/A
	(0,0,0,1)	(0,0,0,1)		(0,0,0,1)			
	(0,0,0,2)	(0,0,1,0)		(0,0,0,2)			
	(0,0,1,0)	(0,0,1,1)		(1,0,0,0)			
	(0,0,1,2)	(1,0,0,0)		(1,0,0,1)			
18	(0,0,0,0)	(0,0,0,0)	(0,0,0,0)	(0,0,0,0)	(0,0,0,0)	(0,0,0,0)	(0,0,0,0)
	(0,0,0,1)	(0,0,0,1)	(0,0,1,0)	(0,0,0,1)	(0,0,0,1)	(1,0,0,0)	(0,0,0,1)
	(0,0,0,2)	(0,0,1,0)	(1,0,0,0)	(0,0,0,2)	(1,0,0,0)	(2,0,0,0)	(0,0,0,2)
	(0,0,1,0)	(0,0,1,1)	(1,0,1,0)	(1,0,0,0)	(1,0,0,1)	(3,0,0,0)	(0,0,1,0)
	(0,0,1,1)	(1,0,0,1)	(2,0,0,0)	(1,0,0,1)	(2,0,0,0)	(4,0,0,0)	(0,0,1,1)
	(0,0,1,2)	(1,0,1,1)	(2,0,1,0)	(1,0,0,2)	(2,0,0,1)	(5,0,0,0)	(1,0,0,2)
19	N/A	(0,0,0,0)	N/A	N/A	N/A	N/A	(0,0,0,0)
		(0,0,0,1)					(0,0,0,1)
		(0,0,1,0)					(0,0,0,2)
		(0,0,1,1)					(0,0,1,0)
		(1,0,0,0)					(0,0,1,1)
		(1,0,1,0)					(1,0,1,1)
20 / 30	(0,1,0,1)	(0,1,0,0)	N/A	(0,1,0,1)	(0,1,0,0)	N/A	(0,1,0,1)
21 / 31	(0,2,0,1)	(0,2,0,0)	N/A	(0,2,0,1)	(0,2,0,0)	N/A	(0,2,0,1)

22 / 32	(0,1,1,1)	(0,1,1,0)	N/A	N/A	N/A	N/A	(0,1,1,0)
23 / 33	(0,0,0,1)	(0,0,0,0)	N/A	(0,0,0,1)	(0,0,0,0)	N/A	(0,0,0,1)
24 / 34	(0,0,1,1)	(0,0,1,0)	N/A	N/A	N/A	N/A	(0,0,1,0)
25 / 35	(0,0,0,1) (0,0,1,1)	(0,0,0,0) (0,0,1,0)	N/A	(0,0,0,1) (1,0,0,1)	(0,0,0,0) (1,0,0,0)	N/A	(0,0,0,1) (0,0,1,0)
26 / 36	(0,0,0,1) (0,0,1,1) (1,0,0,1)	(0,0,0,0) (0,0,1,0) (1,0,0,0)	N/A	(0,0,0,1) (1,0,0,1) (2,0,0,1)	(0,0,0,0) (1,0,0,0) (2,0,0,0)	N/A	(0,0,0,1) (0,0,1,0) (1,0,0,1)
27 / 37	(0,0,0,1) (0,0,1,1) (1,0,0,1) (1,0,1,1)	(0,0,0,0) (0,0,1,0) (1,0,0,0) (1,0,1,0)	N/A	(0,0,0,1) (1,0,0,1) (2,0,0,1) (3,0,0,1)	(0,0,0,0) (1,0,0,0) (2,0,0,0) (3,0,0,0)	N/A	(0,0,0,1) (0,0,1,0) (1,0,0,1) (1,0,1,0)
28 / 38	(0,0,0,1) (0,0,1,1) (1,0,0,1) (1,0,1,1) (2,0,0,1)	(0,0,0,0) (0,0,1,0) (1,0,0,0) (1,0,1,0) (2,0,0,0)	N/A	(0,0,0,1) (1,0,0,1) (2,0,0,1) (3,0,0,1) (4,0,0,1)	(0,0,0,0) (1,0,0,0) (2,0,0,0) (3,0,0,0) (4,0,0,0)	N/A	(0,0,0,1) (0,0,1,0) (1,0,0,1) (1,0,1,0) (2,0,0,1)
29 / 39	(0,0,0,1) (0,0,1,1) (1,0,0,1) (1,0,1,1) (2,0,0,1) (2,0,1,1)	(0,0,0,0) (0,0,1,0) (1,0,0,0) (1,0,1,0) (2,0,0,0) (2,0,1,0)	N/A	(0,0,0,1) (1,0,0,1) (2,0,0,1) (3,0,0,1) (4,0,0,1) (5,0,0,1)	(0,0,0,0) (1,0,0,0) (2,0,0,0) (3,0,0,0) (4,0,0,0) (5,0,0,0)	N/A	(0,0,0,1) (0,0,1,0) (1,0,0,1) (1,0,1,0) (2,0,0,1) (2,0,1,0)
40	(0,1,0,0)	N/A	N/A	(0,1,0,0)	N/A	N/A	(0,1,0,0)
41	(0,2,0,0)	N/A	N/A	(0,2,0,0)	N/A	N/A	(0,2,0,0)
42	(0,1,1,0)	N/A	N/A	N/A	N/A	N/A	N/A
43	(0,0,0,0)	N/A	N/A	(0,0,0,0)	N/A	N/A	(0,0,0,0)
44	(0,0,1,0)	N/A	N/A	N/A	N/A	N/A	N/A
45	(0,0,0,0) (0,0,1,0)	N/A	N/A	(0,0,0,0) (1,0,0,0)	N/A	N/A	(0,0,0,0) (1,0,0,0)
46	(0,0,0,0) (0,0,1,0) (1,0,0,0)	N/A	N/A	(0,0,0,0) (1,0,0,0) (2,0,0,0)	N/A	N/A	(0,0,0,0) (1,0,0,0) (2,0,0,0)
47	(0,0,0,0) (0,0,1,0) (1,0,0,0) (1,0,1,0)	N/A	N/A	(0,0,0,0) (1,0,0,0) (2,0,0,0) (3,0,0,0)	N/A	N/A	(0,0,0,0) (1,0,0,0) (2,0,0,0) (3,0,0,0)
48	(0,1,0,*)	(0,1,0,*)	(0,1,0,*)	(0,1,0,*)	(0,1,0,*)	(0,1,0,*)	(0,1,0,*)
49	(0,2,0,*)	(0,2,0,*)	(0,2,0,*)	(0,2,0,*)	(0,2,0,*)	(0,2,0,*)	(0,2,0,*)
50	(0,1,1,*)	(0,1,1,*)	(0,1,1,*)	N/A	N/A	N/A	(0,1,1,*)
51	(0,0,0,*)	(0,0,0,*)	(0,0,0,*)	(0,0,0,*)	(0,0,0,*)	(0,0,0,*)	(0,0,0,*)
52	(0,0,1,*)	(0,0,1,*)	(0,0,1,*)	N/A	N/A	N/A	(0,0,1,*)
53	(0,0,0,*) (0,0,1,*)	(0,0,0,*) (0,0,1,*)	(0,0,0,*) (0,0,1,*)	(0,0,0,*) (1,0,0,*)	(0,0,0,*) (1,0,0,*)	(0,0,0,*) (1,0,0,*)	(0,0,0,*) (0,0,1,*)
54	(0,0,0,*) (0,0,1,*) (1,0,0,*)	(0,0,0,*) (0,0,1,*) (1,0,0,*)	(0,0,0,*) (0,0,1,*) (1,0,0,*)	(0,0,0,*) (1,0,0,*) (2,0,0,*)	(0,0,0,*) (1,0,0,*) (2,0,0,*)	(0,0,0,*) (1,0,0,*) (2,0,0,*)	(0,0,0,*) (0,0,1,*) (1,0,0,*)
55	(0,0,0,*) (0,0,1,*) (1,0,0,*) (1,0,1,*)	(0,0,0,*) (0,0,1,*) (1,0,0,*) (1,0,1,*)	(0,0,0,*) (0,0,1,*) (1,0,0,*) (1,0,1,*)	(0,0,0,*) (1,0,0,*) (2,0,0,*) (3,0,0,*)	(0,0,0,*) (1,0,0,*) (2,0,0,*) (3,0,0,*)	(0,0,0,*) (1,0,0,*) (2,0,0,*) (3,0,0,*)	(0,0,0,*) (0,0,1,*) (1,0,0,*) (1,0,1,*)
56	(0,0,0,*) (0,0,1,*) (1,0,0,*) (1,0,1,*) (2,0,0,*)	(0,0,0,*) (0,0,1,*) (1,0,0,*) (1,0,1,*) (2,0,0,*)	(0,0,0,*) (0,0,1,*) (1,0,0,*) (1,0,1,*) (2,0,0,*)	(0,0,0,*) (1,0,0,*) (2,0,0,*) (3,0,0,*) (4,0,0,*)	(0,0,0,*) (1,0,0,*) (2,0,0,*) (3,0,0,*) (4,0,0,*)	(0,0,0,*) (1,0,0,*) (2,0,0,*) (3,0,0,*) (4,0,0,*)	(0,0,0,*) (0,0,1,*) (1,0,0,*) (1,0,1,*) (2,0,0,*)
57	(0,0,0,*) (0,0,1,*) (1,0,0,*) (1,0,1,*) (2,0,0,*) (2,0,1,*)	(0,0,0,*) (0,0,1,*) (1,0,0,*) (1,0,1,*) (2,0,0,*) (2,0,1,*)	(0,0,0,*) (0,0,1,*) (1,0,0,*) (1,0,1,*) (2,0,0,*) (2,0,1,*)	(0,0,0,*) (1,0,0,*) (2,0,0,*) (3,0,0,*) (4,0,0,*) (5,0,0,*)	(0,0,0,*) (1,0,0,*) (2,0,0,*) (3,0,0,*) (4,0,0,*) (5,0,0,*)	(0,0,0,*) (1,0,0,*) (2,0,0,*) (3,0,0,*) (4,0,0,*) (5,0,0,*)	(0,0,0,*) (0,0,1,*) (1,0,0,*) (1,0,1,*) (2,0,0,*) (2,0,1,*)
58	N/A	N/A	N/A	N/A	N/A	N/A	N/A
59	N/A	N/A	N/A	N/A	N/A	N/A	N/A
60	N/A	N/A	N/A	N/A	N/A	N/A	N/A
61	N/A	N/A	N/A	N/A	N/A	N/A	N/A
62	N/A	N/A	N/A	N/A	N/A	N/A	N/A

63	N/A	N/A	N/A	N/A	N/A	N/A	N/A
----	-----	-----	-----	-----	-----	-----	-----

* UpPTS

5.7.2 Preamble sequence generation

The random access preambles are generated from Zadoff-Chu sequences with zero correlation zone, generated from one or several root Zadoff-Chu sequences. The network configures the set of preamble sequences the UE is allowed to use.

There are 64 preambles available in each cell. The set of 64 preamble sequences in a cell is found by including first, in the order of increasing cyclic shift, all the available cyclic shifts of a root Zadoff-Chu sequence with the logical index RACH_ROOT_SEQUENCE, where RACH_ROOT_SEQUENCE is broadcasted as part of the System Information. Additional preamble sequences, in case 64 preambles cannot be generated from a single root Zadoff-Chu sequence, are obtained from the root sequences with the consecutive logical indexes until all the 64 sequences are found. The logical root sequence order is cyclic: the logical index 0 is consecutive to 837. The relation between a logical root sequence index and physical root sequence index u is given by Tables 5.7.2-4 and 5.7.2-5 for preamble formats 0 – 3 and 4, respectively.

The u^{th} root Zadoff-Chu sequence is defined by

$$x_u(n) = e^{-j \frac{\pi n(n+1)}{N_{\text{ZC}}}}, \quad 0 \leq n \leq N_{\text{ZC}} - 1$$

where the length N_{ZC} of the Zadoff-Chu sequence is given by Table 5.7.2-1. From the u^{th} root Zadoff-Chu sequence, random access preambles with zero correlation zones of length $N_{\text{CS}} - 1$ are defined by cyclic shifts according to

$$x_{u,v}(n) = x_u((n + C_v) \bmod N_{\text{ZC}})$$

where the cyclic shift is given by

$$C_v = \begin{cases} vN_{\text{CS}} & v = 0, 1, \dots, \lfloor N_{\text{ZC}}/N_{\text{CS}} \rfloor - 1, N_{\text{CS}} \neq 0 & \text{for unrestricted sets} \\ 0 & N_{\text{CS}} = 0 & \text{for unrestricted sets} \\ d_{\text{start}} \lfloor v/n_{\text{shift}}^{\text{RA}} \rfloor + (v \bmod n_{\text{shift}}^{\text{RA}})N_{\text{CS}} & v = 0, 1, \dots, n_{\text{shift}}^{\text{RA}}n_{\text{group}}^{\text{RA}} + \bar{n}_{\text{shift}}^{\text{RA}} - 1 & \text{for restricted sets} \end{cases}$$

and N_{CS} is given by Tables 5.7.2-2 and 5.7.2-3 for preamble formats 0-3 and 4, respectively, where the parameter *zeroCorrelationZoneConfig* is provided by higher layers. The parameter *High-speed-flag* provided by higher layers determines if unrestricted set or restricted set shall be used.

The variable d_u is the cyclic shift corresponding to a Doppler shift of magnitude $1/T_{\text{SEQ}}$ and is given by

$$d_u = \begin{cases} p & 0 \leq p < N_{\text{ZC}}/2 \\ N_{\text{ZC}} - p & \text{otherwise} \end{cases}$$

where p is the smallest non-negative integer that fulfils $(pu) \bmod N_{\text{ZC}} = 1$. The parameters for restricted sets of cyclic shifts depend on d_u . For $N_{\text{CS}} \leq d_u < N_{\text{ZC}}/3$, the parameters are given by

$$\begin{aligned} n_{\text{shift}}^{\text{RA}} &= \lfloor d_u / N_{\text{CS}} \rfloor \\ d_{\text{start}} &= 2d_u + n_{\text{shift}}^{\text{RA}} N_{\text{CS}} \\ n_{\text{group}}^{\text{RA}} &= \lfloor N_{\text{ZC}} / d_{\text{start}} \rfloor \\ \bar{n}_{\text{shift}}^{\text{RA}} &= \max(\lfloor (N_{\text{ZC}} - 2d_u - n_{\text{group}}^{\text{RA}} d_{\text{start}}) / N_{\text{CS}} \rfloor, 0) \end{aligned}$$

For $N_{\text{ZC}}/3 \leq d_u \leq (N_{\text{ZC}} - N_{\text{CS}})/2$, the parameters are given by

$$n_{\text{shift}}^{\text{RA}} = \lfloor (N_{\text{ZC}} - 2d_u) / N_{\text{CS}} \rfloor$$

$$d_{\text{start}} = N_{\text{ZC}} - 2d_u + n_{\text{shift}}^{\text{RA}} N_{\text{CS}}$$

$$n_{\text{group}}^{\text{RA}} = \lfloor d_u / d_{\text{start}} \rfloor$$

$$\bar{n}_{\text{shift}}^{\text{RA}} = \min\left(\max\left(\lfloor (d_u - n_{\text{group}}^{\text{RA}} d_{\text{start}}) / N_{\text{CS}} \rfloor, 0\right), n_{\text{shift}}^{\text{RA}}\right)$$

For all other values of d_u , there are no cyclic shifts in the restricted set.

Table 5.7.2-1: Random access preamble sequence length.

Preamble format	N_{ZC}
0 – 3	839
4	139

Table 5.7.2-2: N_{CS} for preamble generation (preamble formats 0-3).

zeroCorrelationZoneConfig	N_{CS} value	
	Unrestricted set	Restricted set
0	0	15
1	13	18
2	15	22
3	18	26
4	22	32
5	26	38
6	32	46
7	38	55
8	46	68
9	59	82
10	76	100
11	93	128
12	119	158
13	167	202
14	279	237
15	419	-

Table 5.7.2-3: N_{CS} for preamble generation (preamble format 4).

zeroCorrelationZoneConfig	N_{CS} value
0	2
1	4
2	6
3	8
4	10
5	12
6	15
7	N/A
8	N/A
9	N/A
10	N/A
11	N/A
12	N/A
13	N/A
14	N/A
15	N/A

Table 5.7.2-4: Root Zadoff-Chu sequence order for preamble formats 0 – 3.

Logical root sequence number	Physical root sequence number u (in increasing order of the corresponding logical sequence number)
0–23	129, 710, 140, 699, 120, 719, 210, 629, 168, 671, 84, 755, 105, 734, 93, 746, 70, 769, 60, 779, 2, 837, 1, 838
24–29	56, 783, 112, 727, 148, 691
30–35	80, 759, 42, 797, 40, 799
36–41	35, 804, 73, 766, 146, 693
42–51	31, 808, 28, 811, 30, 809, 27, 812, 29, 810
52–63	24, 815, 48, 791, 68, 771, 74, 765, 178, 661, 136, 703
64–75	86, 753, 78, 761, 43, 796, 39, 800, 20, 819, 21, 818
76–89	95, 744, 202, 637, 190, 649, 181, 658, 137, 702, 125, 714, 151, 688
90–115	217, 622, 128, 711, 142, 697, 122, 717, 203, 636, 118, 721, 110, 729, 89, 750, 103, 736, 61, 778, 55, 784, 15, 824, 14, 825
116–135	12, 827, 23, 816, 34, 805, 37, 802, 46, 793, 207, 632, 179, 660, 145, 694, 130, 709, 223, 616
136–167	228, 611, 227, 612, 132, 707, 133, 706, 143, 696, 135, 704, 161, 678, 201, 638, 173, 666, 106, 733, 83, 756, 91, 748, 66, 773, 53, 786, 10, 829, 9, 830
168–203	7, 832, 8, 831, 16, 823, 47, 792, 64, 775, 57, 782, 104, 735, 101, 738, 108, 731, 208, 631, 184, 655, 197, 642, 191, 648, 121, 718, 141, 698, 149, 690, 216, 623, 218, 621
204–263	152, 687, 144, 695, 134, 705, 138, 701, 199, 640, 162, 677, 176, 663, 119, 720, 158, 681, 164, 675, 174, 665, 171, 668, 170, 669, 87, 752, 169, 670, 88, 751, 107, 732, 81, 758, 82, 757, 100, 739, 98, 741, 71, 768, 59, 780, 65, 774, 50, 789, 49, 790, 26, 813, 17, 822, 13, 826, 6, 833
264–327	5, 834, 33, 806, 51, 788, 75, 764, 99, 740, 96, 743, 97, 742, 166, 673, 172, 667, 175, 664, 187, 652, 163, 676, 185, 654, 200, 639, 114, 725, 189, 650, 115, 724, 194, 645, 195, 644, 192, 647, 182, 657, 157, 682, 156, 683, 211, 628, 154, 685, 123, 716, 139, 700, 212, 627, 153, 686, 213, 626, 215, 624, 150, 689
328–383	225, 614, 224, 615, 221, 618, 220, 619, 127, 712, 147, 692, 124, 715, 193, 646, 205, 634, 206, 633, 116, 723, 160, 679, 186, 653, 167, 672, 79, 760, 85, 754, 77, 762, 92, 747, 58, 781, 62, 777, 69, 770, 54, 785, 36, 803, 32, 807, 25, 814, 18, 821, 11, 828, 4, 835
384–455	3, 836, 19, 820, 22, 817, 41, 798, 38, 801, 44, 795, 52, 787, 45, 794, 63, 776, 67, 772, 72, 767, 76, 763, 94, 745, 102, 737, 90, 749, 109, 730, 165, 674, 111, 728, 209, 630, 204, 635, 117, 722, 188, 651, 159, 680, 198, 641, 113, 726, 183, 656, 180, 659, 177, 662, 196, 643, 155, 684, 214, 625, 126, 713, 131, 708, 219, 620, 222, 617, 226, 613
456–513	230, 609, 232, 607, 262, 577, 252, 587, 418, 421, 416, 423, 413, 426, 411, 428, 376, 463, 395, 444, 283, 556, 285, 554, 379, 460, 390, 449, 363, 476, 384, 455, 388, 451, 386, 453, 361, 478, 387, 452, 360, 479, 310, 529, 354, 485, 328, 511, 315, 524, 337, 502, 349, 490, 335, 504, 324, 515
514–561	323, 516, 320, 519, 334, 505, 359, 480, 295, 544, 385, 454, 292, 547, 291, 548, 381, 458, 399, 440, 380, 459, 397, 442, 369, 470, 377, 462, 410, 429, 407, 432, 281, 558, 414, 425, 247, 592, 277, 562, 271, 568, 272, 567, 264, 575, 259, 580
562–629	237, 602, 239, 600, 244, 595, 243, 596, 275, 564, 278, 561, 250, 589, 246, 593, 417, 422, 248, 591, 394, 445, 393, 446, 370, 469, 365, 474, 300, 539, 299, 540, 364, 475, 362, 477, 298, 541, 312, 527, 313, 526, 314, 525, 353, 486, 352, 487, 343, 496, 327, 512, 350, 489, 326, 513, 319, 520, 332, 507, 333, 506, 348, 491, 347, 492, 322, 517
630–659	330, 509, 338, 501, 341, 498, 340, 499, 342, 497, 301, 538, 366, 473, 401, 438, 371, 468, 408, 431, 375, 464, 249, 590, 269, 570, 238, 601, 234, 605
660–707	257, 582, 273, 566, 255, 584, 254, 585, 245, 594, 251, 588, 412, 427, 372, 467, 282, 557, 403, 436, 396, 443, 392, 447, 391, 448, 382, 457, 389, 450, 294, 545, 297, 542, 311, 528, 344, 495, 345, 494, 318, 521, 331, 508, 325, 514, 321, 518
708–729	346, 493, 339, 500, 351, 488, 306, 533, 289, 550, 400, 439, 378, 461, 374, 465, 415, 424, 270, 569, 241, 598
730–751	231, 608, 260, 579, 268, 571, 276, 563, 409, 430, 398, 441, 290, 549, 304, 535, 308, 531, 358, 481, 316, 523
752–765	293, 546, 288, 551, 284, 555, 368, 471, 253, 586, 256, 583, 263, 576
766–777	242, 597, 274, 565, 402, 437, 383, 456, 357, 482, 329, 510
778–789	317, 522, 307, 532, 286, 553, 287, 552, 266, 573, 261, 578
790–795	236, 603, 303, 536, 356, 483
796–803	355, 484, 405, 434, 404, 435, 406, 433
804–809	235, 604, 267, 572, 302, 537
810–815	309, 530, 265, 574, 233, 606
816–819	367, 472, 296, 543
820–837	336, 503, 305, 534, 373, 466, 280, 559, 279, 560, 419, 420, 240, 599, 258, 581, 229, 610

Table 5.7.2-5: Root Zadoff-Chu sequence order for preamble format 4.

Logical root sequence number	Physical root sequence number u (in increasing order of the corresponding logical sequence number)																			
	0 – 19	1	138	2	137	3	136	4	135	5	134	6	133	7	132	8	131	9	130	10
20 – 39	11	128	12	127	13	126	14	125	15	124	16	123	17	122	18	121	19	120	20	119
40 – 59	21	118	22	117	23	116	24	115	25	114	26	113	27	112	28	111	29	110	30	109
60 – 79	31	108	32	107	33	106	34	105	35	104	36	103	37	102	38	101	39	100	40	99
80 – 99	41	98	42	97	43	96	44	95	45	94	46	93	47	92	48	91	49	90	50	89
100 – 119	51	88	52	87	53	86	54	85	55	84	56	83	57	82	58	81	59	80	60	79
120 – 137	61	78	62	77	63	76	64	75	65	74	66	73	67	72	68	71	69	70	-	-
138 – 837	N/A																			

5.7.3 Baseband signal generation

The time-continuous random access signal $s(t)$ is defined by

$$s(t) = \beta_{\text{PRACH}} \sum_{k=0}^{N_{\text{ZC}}-1} \sum_{n=0}^{N_{\text{ZC}}-1} x_{u,v}(n) \cdot e^{-j \frac{2\pi k n}{N_{\text{ZC}}}} \cdot e^{j 2\pi (k + \varphi + K(k_0 + \frac{1}{2})) \Delta f_{\text{RA}} (t - T_{\text{CP}})}$$

where $0 \leq t < T_{\text{SEQ}} + T_{\text{CP}}$, β_{PRACH} is an amplitude scaling factor in order to conform to the transmit power P_{PRACH} specified in Section 6.1 in [4], and $k_0 = n_{\text{PRB}}^{\text{RA}} N_{\text{sc}}^{\text{RB}} - N_{\text{RB}}^{\text{UL}} N_{\text{sc}}^{\text{RB}} / 2$. The location in the frequency domain is controlled by the parameter $n_{\text{PRB}}^{\text{RA}}$ is derived from section 5.7.1. The factor $K = \Delta f / \Delta f_{\text{RA}}$ accounts for the difference in subcarrier spacing between the random access preamble and uplink data transmission. The variable Δf_{RA} , the subcarrier spacing for the random access preamble, and the variable φ , a fixed offset determining the frequency-domain location of the random access preamble within the physical resource blocks, are both given by Table 5.7.3-1.

Table 5.7.3-1: Random access baseband parameters.

Preamble format	Δf_{RA}	φ
0 – 3	1250 Hz	7
4	7500 Hz	2

5.8 Modulation and upconversion

Modulation and upconversion to the carrier frequency of the complex-valued SC-FDMA baseband signal for each antenna port or the complex-valued PRACH baseband signal is shown in Figure 5.8-1. The filtering required prior to transmission is defined by the requirements in [7].

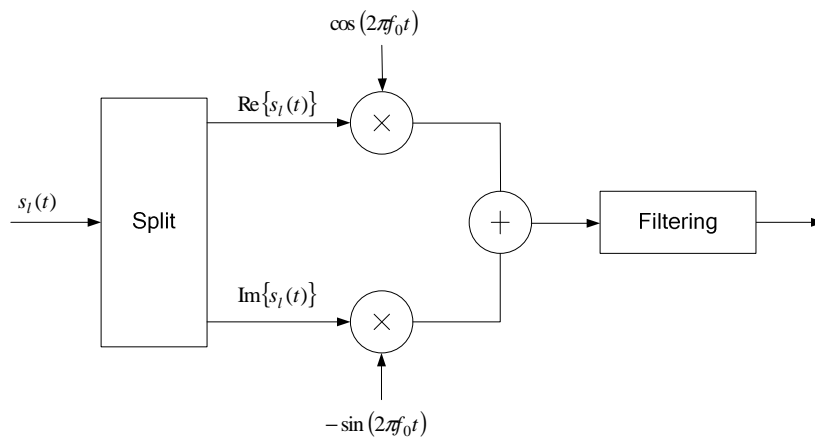

Figure 5.8-1: Uplink modulation.

6 Downlink

6.1 Overview

The smallest time-frequency unit for downlink transmission is denoted a resource element and is defined in Section 6.2.2.

A subset of the downlink subframes in a radio frame on a carrier supporting PDSCH transmission can be configured as MBSFN subframes by higher layers. Each MBSFN subframe is divided into a non-MBSFN region and an MBSFN region.

- The non-MBSFN region spans the first one or two OFDM symbols in an MBSFN subframe where the length of the non-MBSFN region is given by Table 6.7-1.
- The MBSFN region in an MBSFN subframe is defined as the OFDM symbols not used for the non-MBSFN region.

Unless otherwise specified, transmission in each downlink subframe shall use the same cyclic prefix length as used for downlink subframe #0.

6.1.1 Physical channels

A downlink physical channel corresponds to a set of resource elements carrying information originating from higher layers and is the interface defined between 36.212 and 36.211. The following downlink physical channels are defined:

- Physical Downlink Shared Channel, PDSCH
- Physical Broadcast Channel, PBCH
- Physical Multicast Channel, PMCH
- Physical Control Format Indicator Channel, PCFICH
- Physical Downlink Control Channel, PDCCH
- Physical Hybrid ARQ Indicator Channel, PHICH
- Enhanced Physical Downlink Control Channel, EPDCCH

6.1.2 Physical signals

A downlink physical signal corresponds to a set of resource elements used by the physical layer but does not carry information originating from higher layers. The following downlink physical signals are defined:

- Reference signal
- Synchronization signal

6.2 Slot structure and physical resource elements

6.2.1 Resource grid

The transmitted signal in each slot is described by one or several resource grids of $N_{\text{RB}}^{\text{DL}} N_{\text{sc}}^{\text{RB}}$ subcarriers and $N_{\text{symp}}^{\text{DL}}$ OFDM symbols. The resource grid structure is illustrated in Figure 6.2.2-1. The quantity $N_{\text{RB}}^{\text{DL}}$ depends on the downlink transmission bandwidth configured in the cell and shall fulfil

$$N_{\text{RB}}^{\text{min,DL}} \leq N_{\text{RB}}^{\text{DL}} \leq N_{\text{RB}}^{\text{max,DL}}$$

where $N_{\text{RB}}^{\text{min,DL}} = 6$ and $N_{\text{RB}}^{\text{max,DL}} = 110$ are the smallest and largest downlink bandwidths, respectively, supported by the current version of this specification.

The set of allowed values for $N_{\text{RB}}^{\text{DL}}$ is given by [6]. The number of OFDM symbols in a slot depends on the cyclic prefix length and subcarrier spacing configured and is given in Table 6.2.3-1.

An antenna port is defined such that the channel over which a symbol on the antenna port is conveyed can be inferred from the channel over which another symbol on the same antenna port is conveyed. There is one resource grid per antenna port. The set of antenna ports supported depends on the reference signal configuration in the cell:

- Cell-specific reference signals support a configuration of one, two, or four antenna ports and are transmitted on antenna ports $p = 0$, $p \in \{0,1\}$, and $p \in \{0,1,2,3\}$, respectively.
- MBSFN reference signals are transmitted on antenna port $p = 4$.
- UE-specific reference signals associated with PDSCH are transmitted on antenna port(s) $p = 5$, $p = 7$, $p = 8$, or one or several of $p \in \{7,8,9,10,11,12,13,14\}$.
- Demodulation reference signals associated with EPDCCH are transmitted on one or several of $p \in \{107,108,109,110\}$.
- Positioning reference signals are transmitted on antenna port $p = 6$.
- CSI reference signals support a configuration of one, two, four or eight antenna ports and are transmitted on antenna ports $p = 15$, $p = 15,16$, $p = 15,\dots,18$ and $p = 15,\dots,22$, respectively.

Two antenna ports are said to be quasi co-located if the large-scale properties of the channel over which a symbol on one antenna port is conveyed can be inferred from the channel over which a symbol on the other antenna port is conveyed. The large-scale properties include one or more of delay spread, Doppler spread, Doppler shift, average gain, and average delay. A UE shall not assume that two antenna ports are quasi co-located unless specified otherwise.

6.2.2 Resource elements

Each element in the resource grid for antenna port p is called a resource element and is uniquely identified by the index pair (k, l) in a slot where $k = 0, \dots, N_{\text{RB}}^{\text{DL}} N_{\text{sc}}^{\text{RB}} - 1$ and $l = 0, \dots, N_{\text{symp}}^{\text{DL}} - 1$ are the indices in the frequency and time domains, respectively. Resource element (k, l) on antenna port p corresponds to the complex value $a_{k,l}^{(p)}$. When there is no risk for confusion, or no particular antenna port is specified, the index p may be dropped.

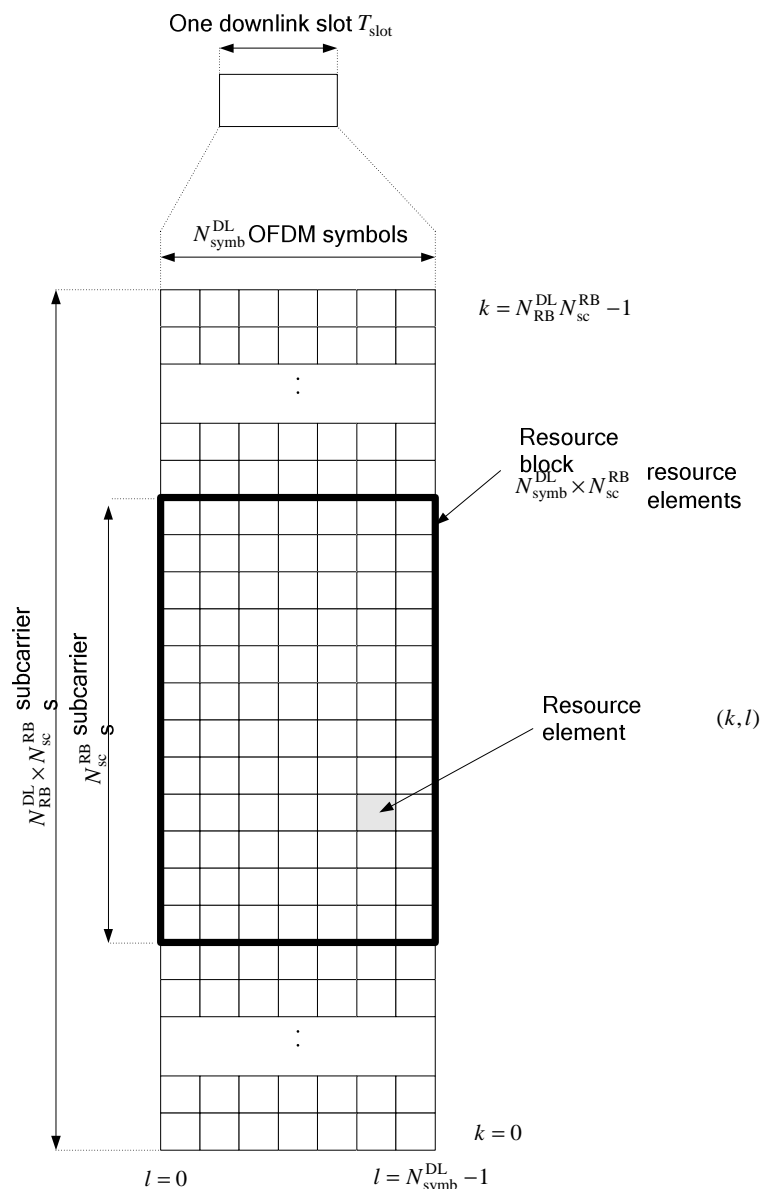

Figure 6.2.2-1: Downlink resource grid.

6.2.3 Resource blocks

Resource blocks are used to describe the mapping of certain physical channels to resource elements. Physical and virtual resource blocks are defined.

A physical resource block is defined as N_{symb}^{DL} consecutive OFDM symbols in the time domain and N_{sc}^{RB} consecutive subcarriers in the frequency domain, where N_{symb}^{DL} and N_{sc}^{RB} are given by Table 6.2.3-1. A physical resource block thus consists of $N_{symb}^{DL} \times N_{sc}^{RB}$ resource elements, corresponding to one slot in the time domain and 180 kHz in the frequency domain.

Physical resource blocks are numbered from 0 to $N_{RB}^{DL} - 1$ in the frequency domain. The relation between the physical resource block number n_{PRB} in the frequency domain and resource elements (k, l) in a slot is given by

$$n_{\text{PRB}} = \left\lfloor \frac{k}{N_{\text{sc}}^{\text{RB}}} \right\rfloor$$

Table 6.2.3-1: Physical resource blocks parameters.

Configuration		$N_{\text{sc}}^{\text{RB}}$	$N_{\text{ymb}}^{\text{DL}}$
Normal cyclic prefix	$\Delta f = 15$ kHz	12	7
Extended cyclic prefix	$\Delta f = 15$ kHz		6
		$\Delta f = 7.5$ kHz	24

A physical resource-block pair is defined as the two physical resource blocks in one subframe having the same physical resource-block number n_{PRB} .

A virtual resource block is of the same size as a physical resource block. Two types of virtual resource blocks are defined:

- Virtual resource blocks of localized type
- Virtual resource blocks of distributed type

For each type of virtual resource blocks, a pair of virtual resource blocks over two slots in a subframe is assigned together by a single virtual resource block number, n_{VRB} .

6.2.3.1 Virtual resource blocks of localized type

Virtual resource blocks of localized type are mapped directly to physical resource blocks such that virtual resource block n_{VRB} corresponds to physical resource block $n_{\text{PRB}} = n_{\text{VRB}}$. Virtual resource blocks are numbered from 0 to $N_{\text{VRB}}^{\text{DL}} - 1$, where $N_{\text{VRB}}^{\text{DL}} = N_{\text{RB}}^{\text{DL}}$.

6.2.3.2 Virtual resource blocks of distributed type

Virtual resource blocks of distributed type are mapped to physical resource blocks as described below.

Table 6.2.3.2-1: RB gap values.

System BW ($N_{\text{RB}}^{\text{DL}}$)	Gap (N_{gap})	
	1 st Gap ($N_{\text{gap},1}$)	2 nd Gap ($N_{\text{gap},2}$)
6-10	$\lceil N_{\text{RB}}^{\text{DL}} / 2 \rceil$	N/A
11	4	N/A
12-19	8	N/A
20-26	12	N/A
27-44	18	N/A
45-49	27	N/A
50-63	27	9
64-79	32	16
80-110	48	16

The parameter N_{gap} is given by Table 6.2.3.2-1. For $6 \leq N_{\text{RB}}^{\text{DL}} \leq 49$, only one gap value $N_{\text{gap},1}$ is defined and $N_{\text{gap}} = N_{\text{gap},1}$. For $50 \leq N_{\text{RB}}^{\text{DL}} \leq 110$, two gap values $N_{\text{gap},1}$ and $N_{\text{gap},2}$ are defined. Whether $N_{\text{gap}} = N_{\text{gap},1}$ or $N_{\text{gap}} = N_{\text{gap},2}$ is signaled as part of the downlink scheduling assignment as described in [3].

Virtual resource blocks of distributed type are numbered from 0 to $N_{\text{VRB}}^{\text{DL}} - 1$, where

$$N_{\text{VRB}}^{\text{DL}} = N_{\text{VRB,gap1}}^{\text{DL}} = 2 \cdot \min(N_{\text{gap}}, N_{\text{RB}}^{\text{DL}} - N_{\text{gap}}) \text{ for } N_{\text{gap}} = N_{\text{gap,1}} \text{ and } N_{\text{VRB}}^{\text{DL}} = N_{\text{VRB,gap2}}^{\text{DL}} = \lfloor N_{\text{RB}}^{\text{DL}} / 2N_{\text{gap}} \rfloor \cdot 2N_{\text{gap}} \text{ for } N_{\text{gap}} = N_{\text{gap,2}}.$$

Consecutive $\tilde{N}_{\text{VRB}}^{\text{DL}}$ VRB numbers compose a unit of VRB number interleaving, where $\tilde{N}_{\text{VRB}}^{\text{DL}} = N_{\text{VRB}}^{\text{DL}}$ for $N_{\text{gap}} = N_{\text{gap,1}}$ and $\tilde{N}_{\text{VRB}}^{\text{DL}} = 2N_{\text{gap}}$ for $N_{\text{gap}} = N_{\text{gap,2}}$. Interleaving of VRB numbers of each interleaving unit is performed with 4 columns and N_{row} rows, where $N_{\text{row}} = \lceil \tilde{N}_{\text{VRB}}^{\text{DL}} / (4P) \rceil P$, and P is RBG size as described in [4]. VRB numbers are written row by row in the rectangular matrix, and read out column by column. N_{null} nulls are inserted in the last $N_{\text{null}} / 2$ rows of the 2nd and 4th column, where $N_{\text{null}} = 4N_{\text{row}} - \tilde{N}_{\text{VRB}}^{\text{DL}}$. Nulls are ignored when reading out. The VRB numbers mapping to PRB numbers including interleaving is derived as follows:

For even slot number n_s ;

$$\tilde{n}_{\text{PRB}}(n_s) = \begin{cases} \tilde{n}'_{\text{PRB}} - N_{\text{row}} & , N_{\text{null}} \neq 0 \text{ and } \tilde{n}_{\text{VRB}} \geq \tilde{N}_{\text{VRB}}^{\text{DL}} - N_{\text{null}} \text{ and } \tilde{n}_{\text{VRB}} \bmod 2 = 1 \\ \tilde{n}'_{\text{PRB}} - N_{\text{row}} + N_{\text{null}} / 2 & , N_{\text{null}} \neq 0 \text{ and } \tilde{n}_{\text{VRB}} \geq \tilde{N}_{\text{VRB}}^{\text{DL}} - N_{\text{null}} \text{ and } \tilde{n}_{\text{VRB}} \bmod 2 = 0 \\ \tilde{n}''_{\text{PRB}} - N_{\text{null}} / 2 & , N_{\text{null}} \neq 0 \text{ and } \tilde{n}_{\text{VRB}} < \tilde{N}_{\text{VRB}}^{\text{DL}} - N_{\text{null}} \text{ and } \tilde{n}_{\text{VRB}} \bmod 4 \geq 2 \\ \tilde{n}''_{\text{PRB}} & , \text{otherwise} \end{cases}$$

$$\text{where } \tilde{n}'_{\text{PRB}} = 2N_{\text{row}} \cdot (\tilde{n}_{\text{VRB}} \bmod 2) + \lfloor \tilde{n}_{\text{VRB}} / 2 \rfloor + \tilde{N}_{\text{VRB}}^{\text{DL}} \cdot \lfloor n_{\text{VRB}} / \tilde{N}_{\text{VRB}}^{\text{DL}} \rfloor,$$

$$\text{and } \tilde{n}''_{\text{PRB}} = N_{\text{row}} \cdot (\tilde{n}_{\text{VRB}} \bmod 4) + \lfloor \tilde{n}_{\text{VRB}} / 4 \rfloor + \tilde{N}_{\text{VRB}}^{\text{DL}} \cdot \lfloor n_{\text{VRB}} / \tilde{N}_{\text{VRB}}^{\text{DL}} \rfloor,$$

where $\tilde{n}_{\text{VRB}} = n_{\text{VRB}} \bmod \tilde{N}_{\text{VRB}}^{\text{DL}}$ and n_{VRB} is obtained from the downlink scheduling assignment as described in [4].

For odd slot number n_s ;

$$\tilde{n}_{\text{PRB}}(n_s) = (\tilde{n}_{\text{PRB}}(n_s - 1) + \tilde{N}_{\text{VRB}}^{\text{DL}} / 2) \bmod \tilde{N}_{\text{VRB}}^{\text{DL}} + \tilde{N}_{\text{VRB}}^{\text{DL}} \cdot \lfloor n_{\text{VRB}} / \tilde{N}_{\text{VRB}}^{\text{DL}} \rfloor$$

Then, for all n_s ;

$$n_{\text{PRB}}(n_s) = \begin{cases} \tilde{n}_{\text{PRB}}(n_s), & \tilde{n}_{\text{PRB}}(n_s) < \tilde{N}_{\text{VRB}}^{\text{DL}} / 2 \\ \tilde{n}_{\text{PRB}}(n_s) + N_{\text{gap}} - \tilde{N}_{\text{VRB}}^{\text{DL}} / 2, & \tilde{n}_{\text{PRB}}(n_s) \geq \tilde{N}_{\text{VRB}}^{\text{DL}} / 2 \end{cases}$$

6.2.4 Resource-element groups

Resource-element groups are used for defining the mapping of control channels to resource elements.

A resource-element group is represented by the index pair (k', l') of the resource element with the lowest index k in the group with all resource elements in the group having the same value of l . The set of resource elements (k, l) in a resource-element group depends on the number of cell-specific reference signals configured as described below with $k_0 = n_{\text{PRB}} \cdot N_{\text{sc}}^{\text{RB}}$, $0 \leq n_{\text{PRB}} < N_{\text{RB}}^{\text{DL}}$.

- In the first OFDM symbol of the first slot in a subframe the two resource-element groups in physical resource block n_{PRB} consist of resource elements $(k, l = 0)$ with $k = k_0 + 0, k_0 + 1, \dots, k_0 + 5$ and $k = k_0 + 6, k_0 + 7, \dots, k_0 + 11$, respectively.
- In the second OFDM symbol of the first slot in a subframe in case of one or two cell-specific reference signals configured, the three resource-element groups in physical resource block n_{PRB} consist of resource elements $(k, l = 1)$ with $k = k_0 + 0, k_0 + 1, \dots, k_0 + 3$, $k = k_0 + 4, k_0 + 5, \dots, k_0 + 7$ and $k = k_0 + 8, k_0 + 9, \dots, k_0 + 11$, respectively.

- In the second OFDM symbol of the first slot in a subframe in case of four cell-specific reference signals configured, the two resource-element groups in physical resource block n_{PRB} consist of resource elements $(k, l = 1)$ with $k = k_0 + 0, k_0 + 1, \dots, k_0 + 5$ and $k = k_0 + 6, k_0 + 7, \dots, k_0 + 11$, respectively.
- In the third OFDM symbol of the first slot in a subframe, the three resource-element groups in physical resource block n_{PRB} consist of resource elements $(k, l = 2)$ with $k = k_0 + 0, k_0 + 1, \dots, k_0 + 3$, $k = k_0 + 4, k_0 + 5, \dots, k_0 + 7$ and $k = k_0 + 8, k_0 + 9, \dots, k_0 + 11$, respectively.
- In the fourth OFDM symbol of the first slot in a subframe in case of normal cyclic prefix, the three resource-element groups in physical resource block n_{PRB} consist of resource elements $(k, l = 3)$ with $k = k_0 + 0, k_0 + 1, \dots, k_0 + 3$, $k = k_0 + 4, k_0 + 5, \dots, k_0 + 7$ and $k = k_0 + 8, k_0 + 9, \dots, k_0 + 11$, respectively.
- In the fourth OFDM symbol of the first slot in a subframe in case of extended cyclic prefix, the two resource-element groups in physical resource block n_{PRB} consist of resource elements $(k, l = 3)$ with $k = k_0 + 0, k_0 + 1, \dots, k_0 + 5$ and $k = k_0 + 6, k_0 + 7, \dots, k_0 + 11$, respectively.

Mapping of a symbol-quadruplet $\langle z(i), z(i+1), z(i+2), z(i+3) \rangle$ onto a resource-element group represented by resource-element (k', l') is defined such that elements $z(i)$ are mapped to resource elements (k, l) of the resource-element group not used for cell-specific reference signals in increasing order of i and k . In case a single cell-specific reference signal is configured, cell-specific reference signals shall be assumed to be present on antenna ports 0 and 1 for the purpose of mapping a symbol-quadruplet to a resource-element group, otherwise the number of cell-specific reference signals shall be assumed equal to the actual number of antenna ports used for cell-specific reference signals. The UE shall not make any assumptions about resource elements assumed to be reserved for reference signals but not used for transmission of a reference signal.

6.2.4A Enhanced resource-element groups

Enhanced resource-element groups (EREGs) are used for defining the mapping of enhanced control channels to resource elements.

There are 16 EREGs, numbered from 0 to 15, per physical resource block pair. Number all resource elements, except resource elements carrying DM-RS for antenna ports $p = \{107, 108, 109, 110\}$ for normal cyclic prefix or $p = \{107, 108\}$ for extended cyclic prefix, in a physical resource-block pair cyclically from 0 to 15 in an increasing order of first frequency, then time. All resource elements with number i in that physical resource-block pair constitutes EREG number i .

6.2.5 Guard period for half-duplex FDD operation

For half-duplex FDD operation, a guard period is created by the UE by not receiving the last part of a downlink subframe immediately preceding an uplink subframe from the same UE.

6.2.6 Guard Period for TDD Operation

For frame structure type 2, the GP field in Figure 4.2-1 serves as a guard period.

6.3 General structure for downlink physical channels

This section describes a general structure, applicable to more than one physical channel.

The baseband signal representing a downlink physical channel is defined in terms of the following steps:

- scrambling of coded bits in each of the codewords to be transmitted on a physical channel
- modulation of scrambled bits to generate complex-valued modulation symbols
- mapping of the complex-valued modulation symbols onto one or several transmission layers
- precoding of the complex-valued modulation symbols on each layer for transmission on the antenna ports

- mapping of complex-valued modulation symbols for each antenna port to resource elements
- generation of complex-valued time-domain OFDM signal for each antenna port

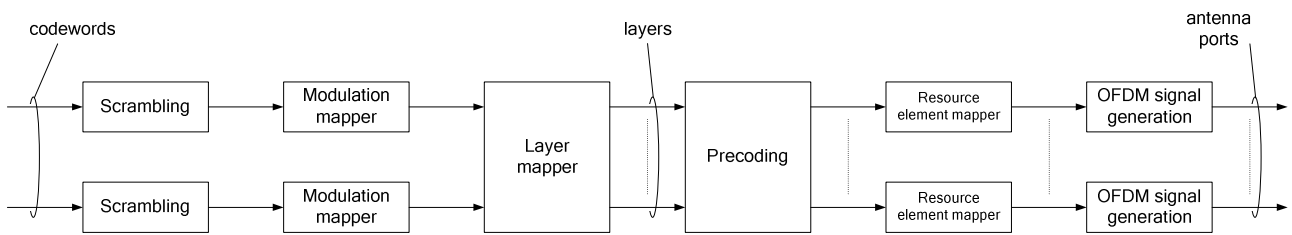

Figure 6.3-1: Overview of physical channel processing.

6.3.1 Scrambling

For each codeword q , the block of bits $b^{(q)}(0), \dots, b^{(q)}(M_{\text{bit}}^{(q)} - 1)$, where $M_{\text{bit}}^{(q)}$ is the number of bits in codeword q transmitted on the physical channel in one subframe, shall be scrambled prior to modulation, resulting in a block of scrambled bits $\tilde{b}^{(q)}(0), \dots, \tilde{b}^{(q)}(M_{\text{bit}}^{(q)} - 1)$ according to

$$\tilde{b}^{(q)}(i) = (b^{(q)}(i) + c^{(q)}(i)) \bmod 2$$

where the scrambling sequence $c^{(q)}(i)$ is given by Section 7.2. The scrambling sequence generator shall be initialised at the start of each subframe, where the initialisation value of c_{init} depends on the transport channel type according to

$$c_{\text{init}} = \begin{cases} n_{\text{RNTI}} \cdot 2^{14} + q \cdot 2^{13} + \lfloor n_s/2 \rfloor \cdot 2^9 + N_{\text{ID}}^{\text{cell}} & \text{for PDSCH} \\ \lfloor n_s/2 \rfloor \cdot 2^9 + N_{\text{ID}}^{\text{MBSFN}} & \text{for PMCH} \end{cases}$$

where n_{RNTI} corresponds to the RNTI associated with the PDSCH transmission as described in Section 7.1[4].

Up to two codewords can be transmitted in one subframe, i.e., $q \in \{0,1\}$. In the case of single codeword transmission, q is equal to zero.

6.3.2 Modulation

For each codeword q , the block of scrambled bits $\tilde{b}^{(q)}(0), \dots, \tilde{b}^{(q)}(M_{\text{bit}}^{(q)} - 1)$ shall be modulated as described in Section 7.1 using one of the modulation schemes in Table 6.3.2-1, resulting in a block of complex-valued modulation symbols $d^{(q)}(0), \dots, d^{(q)}(M_{\text{symp}}^{(q)} - 1)$.

Table 6.3.2-1: Modulation schemes.

Physical channel	Modulation schemes
PDSCH	QPSK, 16QAM, 64QAM
PMCH	QPSK, 16QAM, 64QAM

6.3.3 Layer mapping

The complex-valued modulation symbols for each of the codewords to be transmitted are mapped onto one or several layers. Complex-valued modulation symbols $d^{(q)}(0), \dots, d^{(q)}(M_{\text{symp}}^{(q)} - 1)$ for codeword q shall be mapped onto the

layers $x(i) = [x^{(0)}(i) \ \dots \ x^{(v-1)}(i)]^T$, $i = 0, 1, \dots, M_{\text{symp}}^{\text{layer}} - 1$ where v is the number of layers and $M_{\text{symp}}^{\text{layer}}$ is the number of modulation symbols per layer.

6.3.3.1 Layer mapping for transmission on a single antenna port

For transmission on a single antenna port, a single layer is used, $v = 1$, and the mapping is defined by

$$x^{(0)}(i) = d^{(0)}(i)$$

with $M_{\text{sym}}^{\text{layer}} = M_{\text{sym}}^{(0)}$.

6.3.3.2 Layer mapping for spatial multiplexing

For spatial multiplexing, the layer mapping shall be done according to Table 6.3.3.2-1. The number of layers v is less than or equal to the number of antenna ports P used for transmission of the physical channel. The case of a single codeword mapped to multiple layers is only applicable when the number of cell-specific reference signals is four or when the number of UE-specific reference signals is two or larger.

Table 6.3.3.2-1: Codeword-to-layer mapping for spatial multiplexing.

Number of layers	Number of codewords	Codeword-to-layer mapping $i = 0, 1, \dots, M_{\text{symp}}^{\text{layer}} - 1$
1	1	$x^{(0)}(i) = d^{(0)}(i)$ $M_{\text{symp}}^{\text{layer}} = M_{\text{symp}}^{(0)}$
2	1	$x^{(0)}(i) = d^{(0)}(2i)$ $x^{(1)}(i) = d^{(0)}(2i+1)$ $M_{\text{symp}}^{\text{layer}} = M_{\text{symp}}^{(0)} / 2$
2	2	$x^{(0)}(i) = d^{(0)}(i)$ $x^{(1)}(i) = d^{(1)}(i)$ $M_{\text{symp}}^{\text{layer}} = M_{\text{symp}}^{(0)} = M_{\text{symp}}^{(1)}$
3	1	$x^{(0)}(i) = d^{(0)}(3i)$ $x^{(1)}(i) = d^{(0)}(3i+1)$ $x^{(2)}(i) = d^{(0)}(3i+2)$ $M_{\text{symp}}^{\text{layer}} = M_{\text{symp}}^{(0)} / 3$
3	2	$x^{(0)}(i) = d^{(0)}(i)$ $x^{(1)}(i) = d^{(1)}(2i)$ $x^{(2)}(i) = d^{(1)}(2i+1)$ $M_{\text{symp}}^{\text{layer}} = M_{\text{symp}}^{(0)} = M_{\text{symp}}^{(1)} / 2$
4	1	$x^{(0)}(i) = d^{(0)}(4i)$ $x^{(1)}(i) = d^{(0)}(4i+1)$ $x^{(2)}(i) = d^{(0)}(4i+2)$ $x^{(3)}(i) = d^{(0)}(4i+3)$ $M_{\text{symp}}^{\text{layer}} = M_{\text{symp}}^{(0)} / 4$
4	2	$x^{(0)}(i) = d^{(0)}(2i)$ $x^{(1)}(i) = d^{(0)}(2i+1)$ $x^{(2)}(i) = d^{(1)}(2i)$ $x^{(3)}(i) = d^{(1)}(2i+1)$ $M_{\text{symp}}^{\text{layer}} = M_{\text{symp}}^{(0)} / 2 = M_{\text{symp}}^{(1)} / 2$
5	2	$x^{(0)}(i) = d^{(0)}(2i)$ $x^{(1)}(i) = d^{(0)}(2i+1)$ $x^{(2)}(i) = d^{(1)}(3i)$ $x^{(3)}(i) = d^{(1)}(3i+1)$ $x^{(4)}(i) = d^{(1)}(3i+2)$ $M_{\text{symp}}^{\text{layer}} = M_{\text{symp}}^{(0)} / 2 = M_{\text{symp}}^{(1)} / 3$
6	2	$x^{(0)}(i) = d^{(0)}(3i)$ $x^{(1)}(i) = d^{(0)}(3i+1)$ $x^{(2)}(i) = d^{(0)}(3i+2)$ $x^{(3)}(i) = d^{(1)}(3i)$ $x^{(4)}(i) = d^{(1)}(3i+1)$ $x^{(5)}(i) = d^{(1)}(3i+2)$ $M_{\text{symp}}^{\text{layer}} = M_{\text{symp}}^{(0)} / 3 = M_{\text{symp}}^{(1)} / 3$
7	2	$x^{(0)}(i) = d^{(0)}(3i)$ $x^{(1)}(i) = d^{(0)}(3i+1)$ $x^{(2)}(i) = d^{(0)}(3i+2)$ $x^{(3)}(i) = d^{(1)}(4i)$ $x^{(4)}(i) = d^{(1)}(4i+1)$ $x^{(5)}(i) = d^{(1)}(4i+2)$ $x^{(6)}(i) = d^{(1)}(4i+3)$ $M_{\text{symp}}^{\text{layer}} = M_{\text{symp}}^{(0)} / 3 = M_{\text{symp}}^{(1)} / 4$
8	2	$x^{(0)}(i) = d^{(0)}(4i)$ $x^{(1)}(i) = d^{(0)}(4i+1)$ $x^{(2)}(i) = d^{(0)}(4i+2)$ $x^{(3)}(i) = d^{(0)}(4i+3)$ $M_{\text{symp}}^{\text{layer}} = M_{\text{symp}}^{(0)} / 4 = M_{\text{symp}}^{(1)} / 4$

		$x^{(4)}(i) = d^{(1)}(4i)$ $x^{(5)}(i) = d^{(1)}(4i+1)$ $x^{(6)}(i) = d^{(1)}(4i+2)$ $x^{(7)}(i) = d^{(1)}(4i+3)$
--	--	--

6.3.3.3 Layer mapping for transmit diversity

For transmit diversity, the layer mapping shall be done according to Table 6.3.3.3-1. There is only one codeword and the number of layers ν is equal to the number of antenna ports P used for transmission of the physical channel.

Table 6.3.3.3-1: Codeword-to-layer mapping for transmit diversity.

Number of layers	Number of codewords	Codeword-to-layer mapping	
		$i = 0, 1, \dots, M_{\text{symp}}^{\text{layer}} - 1$	
2	1	$x^{(0)}(i) = d^{(0)}(2i)$ $x^{(1)}(i) = d^{(0)}(2i+1)$	$M_{\text{symp}}^{\text{layer}} = M_{\text{symp}}^{(0)} / 2$
4	1	$x^{(0)}(i) = d^{(0)}(4i)$ $x^{(1)}(i) = d^{(0)}(4i+1)$ $x^{(2)}(i) = d^{(0)}(4i+2)$ $x^{(3)}(i) = d^{(0)}(4i+3)$	$M_{\text{symp}}^{\text{layer}} = \begin{cases} M_{\text{symp}}^{(0)} / 4 & \text{if } M_{\text{symp}}^{(0)} \bmod 4 = 0 \\ (M_{\text{symp}}^{(0)} + 2) / 4 & \text{if } M_{\text{symp}}^{(0)} \bmod 4 \neq 0 \end{cases}$ If $M_{\text{symp}}^{(0)} \bmod 4 \neq 0$ two null symbols shall be appended to $d^{(0)}(M_{\text{symp}}^{(0)} - 1)$

6.3.4 Precoding

The precoder takes as input a block of vectors $x(i) = [x^{(0)}(i) \ \dots \ x^{(\nu-1)}(i)]^T$, $i = 0, 1, \dots, M_{\text{symp}}^{\text{layer}} - 1$ from the layer mapping and generates a block of vectors $y(i) = [\dots \ y^{(p)}(i) \ \dots]^T$, $i = 0, 1, \dots, M_{\text{symp}}^{\text{ap}} - 1$ to be mapped onto resources on each of the antenna ports, where $y^{(p)}(i)$ represents the signal for antenna port p .

6.3.4.1 Precoding for transmission on a single antenna port

For transmission on a single antenna port, precoding is defined by

$$y^{(p)}(i) = x^{(0)}(i)$$

where $p \in \{0, 4, 5, 7, 8\}$ is the number of the single antenna port used for transmission of the physical channel and $i = 0, 1, \dots, M_{\text{symp}}^{\text{ap}} - 1$, $M_{\text{symp}}^{\text{ap}} = M_{\text{symp}}^{\text{layer}}$.

6.3.4.2 Precoding for spatial multiplexing using antenna ports with cell-specific reference signals

Precoding for spatial multiplexing using antenna ports with cell-specific reference signals is only used in combination with layer mapping for spatial multiplexing as described in Section 6.3.3.2. Spatial multiplexing supports two or four antenna ports and the set of antenna ports used is $p \in \{0, 1\}$ or $p \in \{0, 1, 2, 3\}$, respectively.

6.3.4.2.1 Precoding without CDD

Without cyclic delay diversity (CDD), precoding for spatial multiplexing is defined by

$$\begin{bmatrix} y^{(0)}(i) \\ \vdots \\ y^{(P-1)}(i) \end{bmatrix} = W(i) \begin{bmatrix} x^{(0)}(i) \\ \vdots \\ x^{(v-1)}(i) \end{bmatrix}$$

where the precoding matrix $W(i)$ is of size $P \times v$ and $i = 0, 1, \dots, M_{\text{symb}}^{\text{ap}} - 1$, $M_{\text{symb}}^{\text{ap}} = M_{\text{symb}}^{\text{layer}}$.

For spatial multiplexing, the values of $W(i)$ shall be selected among the precoder elements in the codebook configured in the eNodeB and the UE. The eNodeB can further confine the precoder selection in the UE to a subset of the elements in the codebook using codebook subset restrictions. The configured codebook shall be selected from Table 6.3.4.2.3-1 or 6.3.4.2.3-2.

6.3.4.2.2 Precoding for large delay CDD

For large-delay CDD, precoding for spatial multiplexing is defined by

$$\begin{bmatrix} y^{(0)}(i) \\ \vdots \\ y^{(P-1)}(i) \end{bmatrix} = W(i)D(i)U \begin{bmatrix} x^{(0)}(i) \\ \vdots \\ x^{(v-1)}(i) \end{bmatrix}$$

where the precoding matrix $W(i)$ is of size $P \times v$ and $i = 0, 1, \dots, M_{\text{symb}}^{\text{ap}} - 1$, $M_{\text{symb}}^{\text{ap}} = M_{\text{symb}}^{\text{layer}}$. The diagonal size- $v \times v$ matrix $D(i)$ supporting cyclic delay diversity and the size- $v \times v$ matrix U are both given by Table 6.3.4.2.2-1 for different numbers of layers v .

The values of the precoding matrix $W(i)$ shall be selected among the precoder elements in the codebook configured in the eNodeB and the UE. The eNodeB can further confine the precoder selection in the UE to a subset of the elements in the codebook using codebook subset restriction. The configured codebook shall be selected from Table 6.3.4.2.3-1 or 6.3.4.2.3-2.

For 2 antenna ports, the precoder is selected according to $W(i) = C_1$ where C_1 denotes the precoding matrix corresponding to precoder index 0 in Table 6.3.4.2.3-1.

For 4 antenna ports, the UE may assume that the eNodeB cyclically assigns different precoders to different vectors $[x^{(0)}(i) \dots x^{(v-1)}(i)]^T$ on the physical downlink shared channel as follows. A different precoder is used every v vectors, where v denotes the number of transmission layers in the case of spatial multiplexing. In particular, the precoder is selected according to $W(i) = C_k$, where k is the precoder index given by

$$k = \left(\left\lfloor \frac{i}{v} \right\rfloor \bmod 4 \right) + 1 \in \{1, 2, 3, 4\} \text{ and } C_1, C_2, C_3, C_4 \text{ denote precoder matrices corresponding to precoder indices}$$

12, 13, 14 and 15, respectively, in Table 6.3.4.2.3-2.

Table 6.3.4.2.2-1: Large-delay cyclic delay diversity.

Number of layers v	U	$D(i)$
2	$\frac{1}{\sqrt{2}} \begin{bmatrix} 1 & 1 \\ 1 & e^{-j2\pi/2} \end{bmatrix}$	$\begin{bmatrix} 1 & 0 \\ 0 & e^{-j2\pi/2} \end{bmatrix}$
3	$\frac{1}{\sqrt{3}} \begin{bmatrix} 1 & 1 & 1 \\ 1 & e^{-j2\pi/3} & e^{-j4\pi/3} \\ 1 & e^{-j4\pi/3} & e^{-j8\pi/3} \end{bmatrix}$	$\begin{bmatrix} 1 & 0 & 0 \\ 0 & e^{-j2\pi/3} & 0 \\ 0 & 0 & e^{-j4\pi/3} \end{bmatrix}$
4	$\frac{1}{2} \begin{bmatrix} 1 & 1 & 1 & 1 \\ 1 & e^{-j2\pi/4} & e^{-j4\pi/4} & e^{-j6\pi/4} \\ 1 & e^{-j4\pi/4} & e^{-j8\pi/4} & e^{-j12\pi/4} \\ 1 & e^{-j6\pi/4} & e^{-j12\pi/4} & e^{-j18\pi/4} \end{bmatrix}$	$\begin{bmatrix} 1 & 0 & 0 & 0 \\ 0 & e^{-j2\pi/4} & 0 & 0 \\ 0 & 0 & e^{-j4\pi/4} & 0 \\ 0 & 0 & 0 & e^{-j6\pi/4} \end{bmatrix}$

6.3.4.2.3 Codebook for precoding and CSI reporting

For transmission on two antenna ports, $p \in \{0,1\}$, and for the purpose of CSI reporting based on two antenna ports $p \in \{0,1\}$ or $p \in \{15,16\}$, the precoding matrix $W(i)$ shall be selected from Table 6.3.4.2.3-1 or a subset thereof. For the closed-loop spatial multiplexing transmission mode defined in [4], the codebook index 0 is not used when the number of layers is $v = 2$.

Table 6.3.4.2.3-1: Codebook for transmission on antenna ports $\{0,1\}$ and for CSI reporting based on antenna ports $\{0,1\}$ or $\{15,16\}$.

Codebook index	Number of layers v	
	1	2
0	$\frac{1}{\sqrt{2}} \begin{bmatrix} 1 \\ 1 \end{bmatrix}$	$\frac{1}{\sqrt{2}} \begin{bmatrix} 1 & 0 \\ 0 & 1 \end{bmatrix}$
1	$\frac{1}{\sqrt{2}} \begin{bmatrix} 1 \\ -1 \end{bmatrix}$	$\frac{1}{2} \begin{bmatrix} 1 & 1 \\ 1 & -1 \end{bmatrix}$
2	$\frac{1}{\sqrt{2}} \begin{bmatrix} 1 \\ j \end{bmatrix}$	$\frac{1}{2} \begin{bmatrix} 1 & 1 \\ j & -j \end{bmatrix}$
3	$\frac{1}{\sqrt{2}} \begin{bmatrix} 1 \\ -j \end{bmatrix}$	-

For transmission on four antenna ports, $p \in \{0,1,2,3\}$, and for the purpose of CSI reporting based on four antenna ports $p \in \{0,1,2,3\}$ or $p \in \{15,16,17,18\}$, the precoding matrix W shall be selected from Table 6.3.4.2.3-2 or a subset thereof.

The quantity $W_n^{(s)}$ denotes the matrix defined by the columns given by the set $\{s\}$ from the expression

$W_n = I - 2u_n u_n^H / u_n^H u_n$ where I is the 4×4 identity matrix and the vector u_n is given by Table 6.3.4.2.3-2.

Table 6.3.4.2.3-2: Codebook for transmission on antenna ports $\{0,1,2,3\}$ and for CSI reporting based on antenna ports $\{0,1,2,3\}$ or $\{15,16,17,18\}$.

Codebook index	u_n	Number of layers ν			
		1	2	3	4
0	$u_0 = [1 \ -1 \ -1 \ -1]^T$	$W_0^{(1)}$	$W_0^{(14)}/\sqrt{2}$	$W_0^{(124)}/\sqrt{3}$	$W_0^{(1234)}/2$
1	$u_1 = [1 \ -j \ 1 \ j]^T$	$W_1^{(1)}$	$W_1^{(12)}/\sqrt{2}$	$W_1^{(123)}/\sqrt{3}$	$W_1^{(1234)}/2$
2	$u_2 = [1 \ 1 \ -1 \ 1]^T$	$W_2^{(1)}$	$W_2^{(12)}/\sqrt{2}$	$W_2^{(123)}/\sqrt{3}$	$W_2^{(3214)}/2$
3	$u_3 = [1 \ j \ 1 \ -j]^T$	$W_3^{(1)}$	$W_3^{(12)}/\sqrt{2}$	$W_3^{(123)}/\sqrt{3}$	$W_3^{(3214)}/2$
4	$u_4 = [1 \ (-1-j)/\sqrt{2} \ -j \ (1-j)/\sqrt{2}]^T$	$W_4^{(1)}$	$W_4^{(14)}/\sqrt{2}$	$W_4^{(124)}/\sqrt{3}$	$W_4^{(1234)}/2$
5	$u_5 = [1 \ (1-j)/\sqrt{2} \ j \ (-1-j)/\sqrt{2}]^T$	$W_5^{(1)}$	$W_5^{(14)}/\sqrt{2}$	$W_5^{(124)}/\sqrt{3}$	$W_5^{(1234)}/2$
6	$u_6 = [1 \ (1+j)/\sqrt{2} \ -j \ (-1+j)/\sqrt{2}]^T$	$W_6^{(1)}$	$W_6^{(13)}/\sqrt{2}$	$W_6^{(134)}/\sqrt{3}$	$W_6^{(1324)}/2$
7	$u_7 = [1 \ (-1+j)/\sqrt{2} \ j \ (1+j)/\sqrt{2}]^T$	$W_7^{(1)}$	$W_7^{(13)}/\sqrt{2}$	$W_7^{(134)}/\sqrt{3}$	$W_7^{(1324)}/2$
8	$u_8 = [1 \ -1 \ 1 \ 1]^T$	$W_8^{(1)}$	$W_8^{(12)}/\sqrt{2}$	$W_8^{(124)}/\sqrt{3}$	$W_8^{(1234)}/2$
9	$u_9 = [1 \ -j \ -1 \ -j]^T$	$W_9^{(1)}$	$W_9^{(14)}/\sqrt{2}$	$W_9^{(134)}/\sqrt{3}$	$W_9^{(1234)}/2$
10	$u_{10} = [1 \ 1 \ 1 \ -1]^T$	$W_{10}^{(1)}$	$W_{10}^{(13)}/\sqrt{2}$	$W_{10}^{(123)}/\sqrt{3}$	$W_{10}^{(1324)}/2$
11	$u_{11} = [1 \ j \ -1 \ j]^T$	$W_{11}^{(1)}$	$W_{11}^{(13)}/\sqrt{2}$	$W_{11}^{(134)}/\sqrt{3}$	$W_{11}^{(1324)}/2$
12	$u_{12} = [1 \ -1 \ -1 \ 1]^T$	$W_{12}^{(1)}$	$W_{12}^{(12)}/\sqrt{2}$	$W_{12}^{(123)}/\sqrt{3}$	$W_{12}^{(1234)}/2$
13	$u_{13} = [1 \ -1 \ 1 \ -1]^T$	$W_{13}^{(1)}$	$W_{13}^{(13)}/\sqrt{2}$	$W_{13}^{(123)}/\sqrt{3}$	$W_{13}^{(1324)}/2$
14	$u_{14} = [1 \ 1 \ -1 \ -1]^T$	$W_{14}^{(1)}$	$W_{14}^{(13)}/\sqrt{2}$	$W_{14}^{(123)}/\sqrt{3}$	$W_{14}^{(3214)}/2$
15	$u_{15} = [1 \ 1 \ 1 \ 1]^T$	$W_{15}^{(1)}$	$W_{15}^{(12)}/\sqrt{2}$	$W_{15}^{(123)}/\sqrt{3}$	$W_{15}^{(1234)}/2$

For the purpose of CSI reporting for eight CSI reference signals the codebooks are given in section 7.2.4 of [4].

6.3.4.3 Precoding for transmit diversity

Precoding for transmit diversity is only used in combination with layer mapping for transmit diversity as described in Section 6.3.3.3. The precoding operation for transmit diversity is defined for two and four antenna ports.

For transmission on two antenna ports, $p \in \{0,1\}$, the output $y(i) = [y^{(0)}(i) \ y^{(1)}(i)]^T$, $i = 0,1,\dots,M_{\text{symb}}^{\text{ap}} - 1$ of the precoding operation is defined by

$$\begin{bmatrix} y^{(0)}(2i) \\ y^{(1)}(2i) \\ y^{(0)}(2i+1) \\ y^{(1)}(2i+1) \end{bmatrix} = \frac{1}{\sqrt{2}} \begin{bmatrix} 1 & 0 & j & 0 \\ 0 & -1 & 0 & j \\ 0 & 1 & 0 & j \\ 1 & 0 & -j & 0 \end{bmatrix} \begin{bmatrix} \text{Re}(x^{(0)}(i)) \\ \text{Re}(x^{(1)}(i)) \\ \text{Im}(x^{(0)}(i)) \\ \text{Im}(x^{(1)}(i)) \end{bmatrix}$$

for $i = 0,1,\dots,M_{\text{symb}}^{\text{layer}} - 1$ with $M_{\text{symb}}^{\text{ap}} = 2M_{\text{symb}}^{\text{layer}}$.

For transmission on four antenna ports, $p \in \{0,1,2,3\}$, the output $y(i) = [y^{(0)}(i) \ y^{(1)}(i) \ y^{(2)}(i) \ y^{(3)}(i)]^T$, $i = 0,1,\dots,M_{\text{symb}}^{\text{ap}} - 1$ of the precoding operation is defined by

$$\begin{bmatrix} y^{(0)}(4i) \\ y^{(1)}(4i) \\ y^{(2)}(4i) \\ y^{(3)}(4i) \\ y^{(0)}(4i+1) \\ y^{(1)}(4i+1) \\ y^{(2)}(4i+1) \\ y^{(3)}(4i+1) \\ y^{(0)}(4i+2) \\ y^{(1)}(4i+2) \\ y^{(2)}(4i+2) \\ y^{(3)}(4i+2) \\ y^{(0)}(4i+3) \\ y^{(1)}(4i+3) \\ y^{(2)}(4i+3) \\ y^{(3)}(4i+3) \end{bmatrix} = \frac{1}{\sqrt{2}} \begin{bmatrix} 1 & 0 & 0 & 0 & j & 0 & 0 & 0 \\ 0 & 0 & 0 & 0 & 0 & 0 & 0 & 0 \\ 0 & -1 & 0 & 0 & 0 & j & 0 & 0 \\ 0 & 0 & 0 & 0 & 0 & 0 & 0 & 0 \\ 0 & 1 & 0 & 0 & 0 & j & 0 & 0 \\ 0 & 0 & 0 & 0 & 0 & 0 & 0 & 0 \\ 1 & 0 & 0 & 0 & -j & 0 & 0 & 0 \\ 0 & 0 & 0 & 0 & 0 & 0 & 0 & 0 \\ 0 & 0 & 0 & 0 & 0 & 0 & 0 & 0 \\ 0 & 0 & 1 & 0 & 0 & 0 & j & 0 \\ 0 & 0 & 0 & 0 & 0 & 0 & 0 & 0 \\ 0 & 0 & 0 & -1 & 0 & 0 & 0 & j \\ 0 & 0 & 0 & 0 & 0 & 0 & 0 & 0 \\ 0 & 0 & 0 & 1 & 0 & 0 & 0 & j \\ 0 & 0 & 0 & 0 & 0 & 0 & 0 & 0 \\ 0 & 0 & 1 & 0 & 0 & 0 & -j & 0 \end{bmatrix} \begin{bmatrix} \text{Re}\{x^{(0)}(i)\} \\ \text{Re}\{x^{(1)}(i)\} \\ \text{Re}\{x^{(2)}(i)\} \\ \text{Re}\{x^{(3)}(i)\} \\ \text{Im}\{x^{(0)}(i)\} \\ \text{Im}\{x^{(1)}(i)\} \\ \text{Im}\{x^{(2)}(i)\} \\ \text{Im}\{x^{(3)}(i)\} \end{bmatrix}$$

for $i = 0, 1, \dots, M_{\text{symb}}^{\text{layer}} - 1$ with $M_{\text{symb}}^{\text{ap}} = \begin{cases} 4M_{\text{symb}}^{\text{layer}} & \text{if } M_{\text{symb}}^{(0)} \bmod 4 = 0 \\ (4M_{\text{symb}}^{\text{layer}}) - 2 & \text{if } M_{\text{symb}}^{(0)} \bmod 4 \neq 0 \end{cases}$.

6.3.4.4 Precoding for spatial multiplexing using antenna ports with UE-specific reference signals

Precoding for spatial multiplexing using antenna ports with UE-specific reference signals is only used in combination with layer mapping for spatial multiplexing as described in Section 6.3.3.2. Spatial multiplexing using antenna ports with UE-specific reference signals supports up to eight antenna ports and the set of antenna ports used is $p = 7, 8, \dots, v + 6$.

For transmission on v antenna ports, the precoding operation is defined by

$$\begin{bmatrix} y^{(7)}(i) \\ y^{(8)}(i) \\ \vdots \\ y^{(6+v)}(i) \end{bmatrix} = \begin{bmatrix} x^{(0)}(i) \\ x^{(1)}(i) \\ \vdots \\ x^{(v-1)}(i) \end{bmatrix}$$

where $i = 0, 1, \dots, M_{\text{symb}}^{\text{ap}} - 1$, $M_{\text{symb}}^{\text{ap}} = M_{\text{symb}}^{\text{layer}}$.

6.3.5 Mapping to resource elements

For each of the antenna ports used for transmission of the physical channel, the block of complex-valued symbols $y^{(p)}(0), \dots, y^{(p)}(M_{\text{symb}}^{\text{ap}} - 1)$ shall conform to the downlink power allocation specified in Section 5.2 in [4] and be mapped in sequence starting with $y^{(p)}(0)$ to resource elements (k, l) which meet all of the following criteria in the current subframe:

- they are in the physical resource blocks corresponding to the virtual resource blocks assigned for transmission, and
- they are not used for transmission of PBCH, synchronization signals, and
- they are assumed by the UE not to be used for cell-specific reference signals, where the positions of the cell-specific reference signals are given by Section 6.10.1.2 with the number of antenna ports for and the frequency shift of cell-specific reference signals derived as described in Section 6.10.1.2 4], and

The mapping to resource elements (k,l) on antenna port p not reserved for other purposes shall be in increasing order of first the index k over the assigned physical resource blocks and then the index l , starting with the first slot in a subframe.

6.4 Physical downlink shared channel

The physical downlink shared channel shall be processed and mapped to resource elements as described in Section 6.3 with the following additions and exceptions:

- In resource blocks in which UE-specific reference signals are not transmitted, the PDSCH shall be transmitted on the same set of antenna ports as the PBCH, which is one of $\{0\}$, $\{0,1\}$, or $\{0,1,2,3\}$.
- In resource blocks in which UE-specific reference signals are transmitted, the PDSCH shall be transmitted on antenna port(s) $\{5\}$, $\{7\}$, $\{8\}$, or $p \in \{7,8,\dots,\nu+6\}$, where ν is the number of layers used for transmission of the PDSCH.
- If PDSCH is transmitted in MBSFN subframes as defined in [4], the PDSCH shall be transmitted on one or several of antenna port(s) $p \in \{7,8,\dots,\nu+6\}$, where ν is the number of layers used for transmission of the PDSCH.
- PDSCH is not mapped to resource elements used for UE-specific reference signals associated with PDSCH
- In mapping to resource elements, the positions of the cell-specific reference signals are given by Section 6.10.1.2 with the number of antenna ports and the frequency shift of the cell-specific reference signals derived as described in Section 6.10.1.2, unless other values for these parameters are provided by Section 7.1.9 in [4], in which case these values are used in the resource blocks indicated by the relevant DCI.
- If the DCI associated with the PDSCH uses the C-RNTI or semi-persistent C-RNTI, the PDSCH is not mapped to resource elements assumed by the UE to be used for transmission of CSI reference signals, where the positions of the CSI reference signals are given by Section 6.10.5.2. The configuration for zero power CSI reference signals is obtained as described in Section 6.10.5.2, unless other values for these parameters are provided by Section 7.1.9 in [4], in which case these values are used in the resource blocks indicated by the relevant DCI. The configuration for non-zero power CSI reference signals is obtained as described in Section 6.10.5.2.
- PDSCH is not mapped to any physical resource-block pair(s) carrying an EPDCCH associated with the PDSCH.
- The index l in the first slot in a subframe fulfils $l \geq l_{\text{DataStart}}$ where $l_{\text{DataStart}}$ is given by Section 7.1.6.4 of [4].
- In mapping to resource elements, if the DCI associated with the PDSCH uses the C-RNTI or semi-persistent C-RNTI and transmit diversity according to section 6.3.4.3 is used, resource elements in an OFDM symbol assumed by the UE to contain CSI-RS shall be used in the mapping if and only if all of the following criteria are fulfilled:
 - there is an even number of resource elements for the OFDM symbol in each resource block assigned for transmission, and
 - the complex-valued symbols $y^{(p)}(i)$ and $y^{(p)}(i+1)$, where i is an even number, can be mapped to resource elements (k,l) and $(k+n,l)$ in the same OFDM symbol with $n < 3$.

6.5 Physical multicast channel

The physical multicast channel shall be processed and mapped to resource elements as described in Section 6.3 with the following exceptions:

- No transmit diversity scheme is specified.
- Layer mapping and precoding shall be done assuming a single antenna port and the transmission shall use antenna port 4.

- The PMCH can only be transmitted in the MBSFN region of an MBSFN subframe.
- The PMCH shall use extended cyclic prefix.
- The PMCH is not mapped to resource elements used for transmission of MBSFN reference signals.

6.6 Physical broadcast channel

6.6.1 Scrambling

The block of bits $b(0), \dots, b(M_{\text{bit}} - 1)$, where M_{bit} , the number of bits transmitted on the physical broadcast channel, equals 1920 for normal cyclic prefix and 1728 for extended cyclic prefix, shall be scrambled with a cell-specific sequence prior to modulation, resulting in a block of scrambled bits $\tilde{b}(0), \dots, \tilde{b}(M_{\text{bit}} - 1)$ according to

$$\tilde{b}(i) = (b(i) + c(i)) \bmod 2$$

where the scrambling sequence $c(i)$ is given by Section 7.2. The scrambling sequence shall be initialised with $c_{\text{init}} = N_{\text{ID}}^{\text{cell}}$ in each radio frame fulfilling $n_f \bmod 4 = 0$.

6.6.2 Modulation

The block of scrambled bits $\tilde{b}(0), \dots, \tilde{b}(M_{\text{bit}} - 1)$ shall be modulated as described in Section 7.1, resulting in a block of complex-valued modulation symbols $d(0), \dots, d(M_{\text{symb}} - 1)$. Table 6.6.2-1 specifies the modulation mappings applicable for the physical broadcast channel.

Table 6.6.2-1: PBCH modulation schemes.

Physical channel	Modulation schemes
PBCH	QPSK

6.6.3 Layer mapping and precoding

The block of modulation symbols $d(0), \dots, d(M_{\text{symb}} - 1)$ shall be mapped to layers according to one of Sections 6.3.3.1 or 6.3.3.3 with $M_{\text{symb}}^{(0)} = M_{\text{symb}}$ and precoded according to one of Sections 6.3.4.1 or 6.3.4.3, resulting in a block of vectors $y(i) = [y^{(0)}(i) \ \dots \ y^{(P-1)}(i)]^T$, $i = 0, \dots, M_{\text{symb}} - 1$, where $y^{(p)}(i)$ represents the signal for antenna port p and where $p = 0, \dots, P - 1$ and the number of antenna ports for cell-specific reference signals $P \in \{1, 2, 4\}$.

6.6.4 Mapping to resource elements

The block of complex-valued symbols $y^{(p)}(0), \dots, y^{(p)}(M_{\text{symb}} - 1)$ for each antenna port is transmitted during 4 consecutive radio frames starting in each radio frame fulfilling $n_f \bmod 4 = 0$ and shall be mapped in sequence starting with $y(0)$ to resource elements (k, l) . The mapping to resource elements (k, l) not reserved for transmission of reference signals shall be in increasing order of first the index k , then the index l in slot 1 in subframe 0 and finally the radio frame number. The resource-element indices are given by

$$k = \frac{N_{\text{RB}}^{\text{DL}} N_{\text{sc}}^{\text{RB}}}{2} - 36 + k', \quad k' = 0, 1, \dots, 71$$

$$l = 0, 1, \dots, 3$$

where resource elements reserved for reference signals shall be excluded. The mapping operation shall assume cell-specific reference signals for antenna ports 0-3 being present irrespective of the actual configuration. The UE shall assume that the resource elements assumed to be reserved for reference signals in the mapping operation above but not

used for transmission of reference signal are not available for PDSCH transmission. The UE shall not make any other assumptions about these resource elements.

6.7 Physical control format indicator channel

The physical control format indicator channel carries information about the number of OFDM symbols used for transmission of PDCCHs in a subframe. The set of OFDM symbols possible to use for PDCCH in a subframe is given by Table 6.7-1.

Table 6.7-1: Number of OFDM symbols used for PDCCH.

Subframe	Number of OFDM symbols for PDCCH when $N_{RB}^{DL} > 10$	Number of OFDM symbols for PDCCH when $N_{RB}^{DL} \leq 10$
Subframe 1 and 6 for frame structure type 2	1, 2	2
MBSFN subframes on a carrier supporting PDSCH, configured with 1 or 2 cell-specific antenna ports	1, 2	2
MBSFN subframes on a carrier supporting PDSCH, configured with 4 cell-specific antenna ports	2	2
Subframes on a carrier not supporting PDSCH	0	0
Non-MBSFN subframes (except subframe 6 for frame structure type 2) configured with positioning reference signals	1, 2, 3	2, 3
All other cases	1, 2, 3	2, 3, 4

The PCFICH shall be transmitted when the number of OFDM symbols for PDCCH is greater than zero.

6.7.1 Scrambling

The block of bits $b(0), \dots, b(31)$ transmitted in one subframe shall be scrambled with a cell-specific sequence prior to modulation, resulting in a block of scrambled bits $\tilde{b}(0), \dots, \tilde{b}(31)$ according to

$$\tilde{b}(i) = (b(i) + c(i)) \bmod 2$$

where the scrambling sequence $c(i)$ is given by Section 7.2. The scrambling sequence generator shall be initialised with $c_{\text{init}} = (\lfloor n_s/2 \rfloor + 1) \cdot (2N_{ID}^{\text{cell}} + 1) \cdot 2^9 + N_{ID}^{\text{cell}}$ at the start of each subframe.

6.7.2 Modulation

The block of scrambled bits $\tilde{b}(0), \dots, \tilde{b}(31)$ shall be modulated as described in Section 7.1, resulting in a block of complex-valued modulation symbols $d(0), \dots, d(15)$. Table 6.7.2-1 specifies the modulation mappings applicable for the physical control format indicator channel.

Table 6.7.2-1: PCFICH modulation schemes.

Physical channel	Modulation schemes
PCFICH	QPSK

6.7.3 Layer mapping and precoding

The block of modulation symbols $d(0), \dots, d(15)$ shall be mapped to layers according to one of Sections 6.3.3.1 or 6.3.3.3 with $M_{\text{symb}}^{(0)} = 16$ and precoded according to one of Sections 6.3.4.1 or 6.3.4.3, resulting in a block of vectors

$$y(i) = [y^{(0)}(i) \ \dots \ y^{(P-1)}(i)]^T, \quad i = 0, \dots, 15, \quad \text{where } y^{(p)}(i) \text{ represents the signal for antenna port } p \text{ and where}$$

$p = 0, \dots, P-1$ and the number of antenna ports for cell-specific reference signals $P \in \{1, 2, 4\}$. The PCFICH shall be transmitted on the same set of antenna ports as the PBCH.

6.7.4 Mapping to resource elements

The mapping to resource elements is defined in terms of quadruplets of complex-valued symbols. Let

$z^{(p)}(i) = \langle y^{(p)}(4i), y^{(p)}(4i+1), y^{(p)}(4i+2), y^{(p)}(4i+3) \rangle$ denote symbol quadruplet i for antenna port p . For each of the antenna ports, symbol quadruplets shall be mapped in increasing order of i to the four resource-element groups in the first OFDM symbol in a downlink subframe with the representative resource-element as defined in Section 6.2.4 given by

$$\begin{aligned} z^{(p)}(0) & \text{ is mapped to the resource - element group represented by } k = \bar{k} \\ z^{(p)}(1) & \text{ is mapped to the resource - element group represented by } k = \bar{k} + \left\lfloor N_{\text{RB}}^{\text{DL}}/2 \right\rfloor \cdot N_{\text{sc}}^{\text{RB}}/2 \\ z^{(p)}(2) & \text{ is mapped to the resource - element group represented by } k = \bar{k} + \left\lfloor 2N_{\text{RB}}^{\text{DL}}/2 \right\rfloor \cdot N_{\text{sc}}^{\text{RB}}/2 \\ z^{(p)}(3) & \text{ is mapped to the resource - element group represented by } k = \bar{k} + \left\lfloor 3N_{\text{RB}}^{\text{DL}}/2 \right\rfloor \cdot N_{\text{sc}}^{\text{RB}}/2 \end{aligned}$$

where the additions are modulo $N_{\text{RB}}^{\text{DL}} N_{\text{sc}}^{\text{RB}}$,

$$\bar{k} = \left(N_{\text{sc}}^{\text{RB}}/2 \right) \cdot \left(N_{\text{ID}}^{\text{cell}} \bmod 2N_{\text{RB}}^{\text{DL}} \right)$$

and $N_{\text{ID}}^{\text{cell}}$ is the physical-layer cell identity as given by Section 6.11.

6.8 Physical downlink control channel

6.8.1 PDCCH formats

The physical downlink control channel carries scheduling assignments and other control information. A physical control channel is transmitted on an aggregation of one or several consecutive control channel elements (CCEs), where a control channel element corresponds to 9 resource element groups. The number of resource-element groups not assigned to PCFICH or PHICH is N_{REG} . The CCEs available in the system are numbered from 0 to $N_{\text{CCE}} - 1$, where $N_{\text{CCE}} = \lfloor N_{\text{REG}}/9 \rfloor$. The PDCCH supports multiple formats as listed in Table 6.8.1-1. A PDCCH consisting of n consecutive CCEs may only start on a CCE fulfilling $i \bmod n = 0$, where i is the CCE number.

Multiple PDCCHs can be transmitted in a subframe.

Table 6.8.1-1: Supported PDCCH formats.

PDCCH format	Number of CCEs	Number of resource-element groups	Number of PDCCH bits
0	1	9	72
1	2	18	144
2	4	36	288
3	8	72	576

6.8.2 PDCCH multiplexing and scrambling

The block of bits $b^{(i)}(0), \dots, b^{(i)}(M_{\text{bit}}^{(i)} - 1)$ on each of the control channels to be transmitted in a subframe, where $M_{\text{bit}}^{(i)}$ is the number of bits in one subframe to be transmitted on physical downlink control channel number i , shall be multiplexed, resulting in a block of bits

$b^{(0)}(0), \dots, b^{(0)}(M_{\text{bit}}^{(0)} - 1), b^{(1)}(0), \dots, b^{(1)}(M_{\text{bit}}^{(1)} - 1), \dots, b^{(n_{\text{PDCCH}} - 1)}(0), \dots, b^{(n_{\text{PDCCH}} - 1)}(M_{\text{bit}}^{(n_{\text{PDCCH}} - 1)} - 1)$, where n_{PDCCH} is the number of PDCCHs transmitted in the subframe.

The block of bits $b^{(0)}(0), \dots, b^{(0)}(M_{\text{bit}}^{(0)} - 1), b^{(1)}(0), \dots, b^{(1)}(M_{\text{bit}}^{(1)} - 1), \dots, b^{(n_{\text{PDCCH}} - 1)}(0), \dots, b^{(n_{\text{PDCCH}} - 1)}(M_{\text{bit}}^{(n_{\text{PDCCH}} - 1)} - 1)$ shall be scrambled with a cell-specific sequence prior to modulation, resulting in a block of scrambled bits $\tilde{b}(0), \dots, \tilde{b}(M_{\text{tot}} - 1)$ according to

$$\tilde{b}(i) = (b(i) + c(i)) \bmod 2$$

where the scrambling sequence $c(i)$ is given by Section 7.2. The scrambling sequence generator shall be initialised with $c_{\text{init}} = \lfloor n_s/2 \rfloor 2^9 + N_{\text{ID}}^{\text{cell}}$ at the start of each subframe.

CCE number n corresponds to bits $b(72n), b(72n+1), \dots, b(72n+71)$. If necessary, <NIL> elements shall be inserted in the block of bits prior to scrambling to ensure that the PDCCHs starts at the CCE positions as described in [4] and to ensure that the length $M_{\text{tot}} = 8N_{\text{REG}} \geq \sum_{i=0}^{n_{\text{PDCCH}} - 1} M_{\text{bit}}^{(i)}$ of the scrambled block of bits matches the amount of resource-element groups not assigned to PCFICH or PHICH.

6.8.3 Modulation

The block of scrambled bits $\tilde{b}(0), \dots, \tilde{b}(M_{\text{tot}} - 1)$ shall be modulated as described in Section 7.1, resulting in a block of complex-valued modulation symbols $d(0), \dots, d(M_{\text{symp}} - 1)$. Table 6.8.3-1 specifies the modulation mappings applicable for the physical downlink control channel.

Table 6.8.3-1: PDCCH modulation schemes.

Physical channel	Modulation schemes
PDCCH	QPSK

6.8.4 Layer mapping and precoding

The block of modulation symbols $d(0), \dots, d(M_{\text{symp}} - 1)$ shall be mapped to layers according to one of Sections 6.3.3.1 or 6.3.3.3 with $M_{\text{symp}}^{(0)} = M_{\text{symp}}$ and precoded according to one of Sections 6.3.4.1 or 6.3.4.3, resulting in a block of vectors $y(i) = [y^{(0)}(i) \ \dots \ y^{(P-1)}(i)]^T$, $i = 0, \dots, M_{\text{symp}} - 1$ to be mapped onto resources on the antenna ports used for transmission, where $y^{(p)}(i)$ represents the signal for antenna port p . The PDCCH shall be transmitted on the same set of antenna ports as the PBCH.

6.8.5 Mapping to resource elements

The mapping to resource elements is defined by operations on quadruplets of complex-valued symbols. Let $z^{(p)}(i) = \langle y^{(p)}(4i), y^{(p)}(4i+1), y^{(p)}(4i+2), y^{(p)}(4i+3) \rangle$ denote symbol quadruplet i for antenna port p .

The block of quadruplets $z^{(p)}(0), \dots, z^{(p)}(M_{\text{quad}} - 1)$, where $M_{\text{quad}} = M_{\text{symp}}/4$, shall be permuted resulting in $w^{(p)}(0), \dots, w^{(p)}(M_{\text{quad}} - 1)$. The permutation shall be according to the sub-block interleaver in Section 5.1.4.2.1 of [3] with the following exceptions:

- the input and output to the interleaver is defined by symbol quadruplets instead of bits
- interleaving is performed on symbol quadruplets instead of bits by substituting the terms 'bit', 'bits' and 'bit sequence' in Section 5.1.4.2.1 of [3] by 'symbol quadruplet', 'symbol quadruplets' and 'symbol-quadruplet sequence', respectively

<NULL> elements at the output of the interleaver in [3] shall be removed when forming $w^{(p)}(0), \dots, w^{(p)}(M_{\text{quad}} - 1)$.

Note that the removal of <NULL> elements does not affect any <NIL> elements inserted in Section 6.8.2.

The block of quadruplets $w^{(p)}(0), \dots, w^{(p)}(M_{\text{quad}} - 1)$ shall be cyclically shifted, resulting in $\bar{w}^{(p)}(0), \dots, \bar{w}^{(p)}(M_{\text{quad}} - 1)$ where $\bar{w}^{(p)}(i) = w^{(p)}\left((i + N_{\text{ID}}^{\text{cell}}) \bmod M_{\text{quad}}\right)$.

Mapping of the block of quadruplets $\bar{w}^{(p)}(0), \dots, \bar{w}^{(p)}(M_{\text{quad}} - 1)$ is defined in terms of resource-element groups, specified in Section 6.2.4, according to steps 1–10 below:

- 1) Initialize $m' = 0$ (resource-element group number)
- 2) Initialize $k' = 0$
- 3) Initialize $l' = 0$
- 4) If the resource element (k', l') represents a resource-element group and the resource-element group is not assigned to PCFICH or PHICH then perform step 5 and 6, else go to step 7
- 5) Map symbol-quadruplet $\bar{w}^{(p)}(m')$ to the resource-element group represented by (k', l') for each antenna port p
- 6) Increase m' by 1
- 7) Increase l' by 1
- 8) Repeat from step 4 if $l' < L$, where L corresponds to the number of OFDM symbols used for PDCCH transmission as indicated by the sequence transmitted on the PCFICH
- 9) Increase k' by 1
- 10) Repeat from step 3 if $k' < N_{\text{RB}}^{\text{DL}} \cdot N_{\text{sc}}^{\text{RB}}$

6.8A Enhanced physical downlink control channel

6.8A.1 EPDCCH formats

The enhanced physical downlink control channel (EPDCCH) carries scheduling assignments. An enhanced physical downlink control channel is transmitted using an aggregation of one or several consecutive enhanced control channel elements (ECCEs) where each ECCE consists of multiple enhanced resource element groups (EREGs), defined in Section 6.2.4A. The number of ECCEs used for one EPDCCH depends on the EPDCCH format as given by Table 6.8A.1-2 and the number of EREGs per ECCE is given by Table 6.8A.1-1. Both localized and distributed transmission is supported.

An EPDCCH can use either localized or distributed transmission, differing in the mapping of ECCEs to EREGs and PRB pairs.

A UE shall monitor multiple EPDCCHs as defined in [4]. One or two sets of physical resource-block pairs which a UE shall monitor for EPDCCH transmissions can be configured. All EPDCCH candidates in EPDCCH set X_m use either only localized or only distributed transmission as configured by higher layers. Within EPDCCH set X_m in subframe i , the ECCEs available for transmission of EPDCCHs are numbered from 0 to $N_{\text{ECCE},m,i} - 1$ and ECCE number n corresponds to

- EREGs numbered $(n \bmod N_{\text{ECCE}}^{\text{RB}}) + jN_{\text{ECCE}}^{\text{RB}}$ in PRB index $\lfloor n / N_{\text{ECCE}}^{\text{RB}} \rfloor$ for localized mapping, and
- EREGs numbered $\lfloor n / N_{\text{RB}}^{X_m} \rfloor + jN_{\text{ECCE}}^{\text{RB}}$ in PRB indices $(n + j \max(1, N_{\text{RB}}^{X_m} / N_{\text{EREG}}^{\text{ECCE}})) \bmod N_{\text{RB}}^{X_m}$ for distributed mapping,

where $j = 0, 1, \dots, N_{\text{EREG}}^{\text{ECCE}} - 1$, $N_{\text{EREG}}^{\text{ECCE}}$ is the number of EREGs per ECCE, and $N_{\text{ECCE}}^{\text{RB}} = 16 / N_{\text{EREG}}^{\text{ECCE}}$ is the number of ECCEs per resource-block pair. The physical resource-block pairs constituting EPDCCH set X_m are in this paragraph assumed to be numbered in ascending order from 0 to $N_{\text{RB}}^{X_m} - 1$.

Table 6.8A.1-1: Number of EREGs per ECCE, $N_{\text{EREG}}^{\text{ECCE}}$.

Normal subframe	Normal cyclic prefix		Extended cyclic prefix	
	Special subframe, configuration 3, 4, 8	Special subframe, configuration 1, 2, 6, 7, 9	Normal subframe	Special subframe, configuration 1, 2, 3, 5, 6
	4		8	

Table 6.8A.1-2: Supported EPDCCH formats.

EPDCCH format	Number of ECCEs for one EPDCCH, $N_{\text{ECCE}}^{\text{EPDCCH}}$			
	Case A		Case B	
	Localized transmission	Distributed transmission	Localized transmission	Distributed transmission
0	2	2	1	1
1	4	4	2	2
2	8	8	4	4
3	16	16	8	8
4	-	32	-	16

Case A in Table 6.8A.1-2 is used when the conditions corresponding to case 1 in Section 9.1.4 of [4] are satisfied, otherwise case B is used. The quantity n_{EPDCCH} for a particular UE and referenced in [4] is defined as the number of downlink resource elements (k, l) in a physical resource-block pair configured for possible EPDCCH transmission of EPDCCH set X_0 and fulfilling all of the following criteria:

- they are part of any one of the 16 EREGs in the physical resource-block pair, and
- they are assumed by the UE not to be used for cell-specific reference signals, where the positions of the cell-specific reference signals are given by Section 6.10.1.2 with the number of antenna ports for and the frequency shift of cell-specific reference signals derived as described in Section 6.10.1.2 unless other values for these parameters are provided by Section 9.1.4.3 in [4], and-
- they are assumed by the UE not to be used for transmission of CSI reference signals, where the positions of the CSI reference signals are given by Section 6.10.5.2 with the configuration for zero power CSI reference signals obtained as described in Section 6.10.5.2 unless other values are provided by Section 9.1.4.3 in [4], and with the configuration for non-zero power CSI reference signals obtained as described in Section 6.10.5.2, and
- the index l in the first slot in a subframe fulfils $l \geq l_{\text{EPDCCHstart}}$ where $l_{\text{EPDCCHstart}}$ is given by Section 9.1.4.1 of [4].

6.8A.2 Scrambling

The block of bits $b(0), \dots, b(M_{\text{bit}} - 1)$ to be transmitted on an EPDCCH in a subframe shall be scrambled, resulting in a block of scrambled bits $\tilde{b}(0), \dots, \tilde{b}(M_{\text{bit}} - 1)$ according to

$$\tilde{b}(i) = (b(i) + c(i)) \bmod 2$$

where the UE-specific scrambling sequence $c(i)$ is given by Section 7.2. The scrambling sequence generator shall be initialized with $c_{\text{init}} = \lfloor n_s / 2 \rfloor \cdot 2^9 + n_{\text{ID}, m}^{\text{EPDCCH}}$ where m is the EPDCCH set number.

6.8A.3 Modulation

The block of scrambled bits $\tilde{b}(0), \dots, \tilde{b}(M_{\text{bit}} - 1)$ shall be modulated as described in Section 7.1, resulting in a block of complex-valued modulation symbols $d(0), \dots, d(M_{\text{symb}} - 1)$. Table 6.8A.3-1 specifies the modulation mappings applicable for the enhanced physical downlink control channel.

Table 6.8A.3-1: EPDCCH modulation schemes.

Physical channel	Modulation schemes
EPDCCH	QPSK

6.8A.4 Layer mapping and precoding

The block of complex-valued modulation symbols shall be mapped to a single layer and precoded according to $y(i) = d(i)$, $i = 0, \dots, M_{\text{symb}} - 1$.

6.8A.5 Mapping to resource elements

The block of complex-valued symbols $y(0), \dots, y(M_{\text{symb}} - 1)$ shall be mapped in sequence starting with $y(0)$ to resource elements (k, l) on the associated antenna port which meet all of the following criteria:

- they are part of the EREGs assigned for the EPDCCH transmission, and
- they are assumed by the UE not to be used for cell-specific reference signals, where the positions of the cell-specific reference signals are given by Section 6.10.1.2 with the number of antenna ports for and the frequency shift of cell-specific reference signals derived as described in Section 6.10.1.2 unless other values for these parameters are provided by Section 9.1.4.3 in [4], and
- they are assumed by the UE not to be used for transmission of CSI reference signals, where the positions of the CSI reference signals are given by Section 6.10.5.2 with the configuration for zero power CSI reference signals obtained as described in Section 6.10.5.2 unless other values are provided by Section 9.1.4.3 in [4], and with the configuration for non-zero power CSI reference signals obtained as described in Section 6.10.5.2, and
- the index l in the first slot in a subframe fulfils $l \geq l_{\text{EPDCCHstart}}$ where $l_{\text{EPDCCHstart}}$ is given by Section 9.1.4.1 of [4].

The mapping to resource elements (k, l) on antenna port p meeting the criteria above shall be in increasing order of first the index k and then the index l , starting with the first slot and ending with the second slot in a subframe.

For localized transmission, the single antenna port p to use is given by Table 6.8A.5-1 with

$$n' = n_{\text{ECCE,low}} \bmod N_{\text{ECCE}}^{\text{RB}} + n_{\text{RNTI}} \bmod \min(N_{\text{ECCE}}^{\text{EPDCCH}}, N_{\text{ECCE}}^{\text{RB}})$$

where $n_{\text{ECCE,low}}$ is the lowest ECCE index used by this EPDCCH transmission in the EPDCCH set, n_{RNTI} equals the C-RNTI, and $N_{\text{ECCE}}^{\text{EPDCCH}}$ is the number of ECCEs used for this EPDCCH.

Table 6.8A.5-1: Antenna port to use for localized EPDCCH transmission.

n'	Normal cyclic prefix		Extended cyclic prefix
	Normal subframes, Special subframes, configurations 3, 4, 8	Special subframes, configurations 1, 2, 6, 7, 9	Any subframe
0	107	107	107
1	108	109	108
2	109	-	-
3	110	-	-

For distributed transmission, each resource element in an EREG is associated with one out of two antenna ports in an alternating manner, starting with antenna port 107, where $p \in \{107,109\}$ for normal cyclic prefix and $p \in \{107,108\}$ for extended cyclic prefix.

6.9 Physical hybrid ARQ indicator channel

The PHICH carries the hybrid-ARQ ACK/NACK. Multiple PHICHs mapped to the same set of resource elements constitute a PHICH group, where PHICHs within the same PHICH group are separated through different orthogonal sequences. A PHICH resource is identified by the index pair $(n_{\text{PHICH}}^{\text{group}}, n_{\text{PHICH}}^{\text{seq}})$, where $n_{\text{PHICH}}^{\text{group}}$ is the PHICH group number and $n_{\text{PHICH}}^{\text{seq}}$ is the orthogonal sequence index within the group.

For frame structure type 1, the number of PHICH groups $N_{\text{PHICH}}^{\text{group}}$ is constant in all subframes and given by

$$N_{\text{PHICH}}^{\text{group}} = \begin{cases} \lceil N_g (N_{\text{RB}}^{\text{DL}} / 8) \rceil & \text{for normal cyclic prefix} \\ 2 \cdot \lceil N_g (N_{\text{RB}}^{\text{DL}} / 8) \rceil & \text{for extended cyclic prefix} \end{cases}$$

where $N_g \in \{1/6, 1/2, 1, 2\}$ is provided by higher layers. The index $n_{\text{PHICH}}^{\text{group}}$ ranges from 0 to $N_{\text{PHICH}}^{\text{group}} - 1$.

For frame structure type 2, the number of PHICH groups may vary between downlink subframes and is given by $m_i \cdot N_{\text{PHICH}}^{\text{group}}$ where m_i is given by Table 6.9-1 and $N_{\text{PHICH}}^{\text{group}}$ by the expression above. The index $n_{\text{PHICH}}^{\text{group}}$ in a downlink subframe with non-zero PHICH resources ranges from 0 to $m_i \cdot N_{\text{PHICH}}^{\text{group}} - 1$.

Table 6.9-1: The factor m_i for frame structure type 2.

Uplink-downlink configuration	Subframe number i									
	0	1	2	3	4	5	6	7	8	9
0	2	1	-	-	-	2	1	-	-	-
1	0	1	-	-	1	0	1	-	-	1
2	0	0	-	1	0	0	0	-	1	0
3	1	0	-	-	-	0	0	0	1	1
4	0	0	-	-	0	0	0	0	1	1
5	0	0	-	0	0	0	0	0	1	0
6	1	1	-	-	-	1	1	-	-	1

6.9.1 Modulation

The block of bits $b(0), \dots, b(M_{\text{bit}} - 1)$ transmitted on one PHICH in one subframe shall be modulated as described in Section 7.1, resulting in a block of complex-valued modulation symbols $z(0), \dots, z(M_s - 1)$, where $M_s = M_{\text{bit}}$. Table 6.9.1-1 specifies the modulation mappings applicable for the physical hybrid ARQ indicator channel.

Table 6.9.1-1: PHICH modulation schemes.

Physical channel	Modulation schemes
PHICH	BPSK

The block of modulation symbols $z(0), \dots, z(M_s - 1)$ shall be symbol-wise multiplied with an orthogonal sequence and scrambled, resulting in a sequence of modulation symbols $d(0), \dots, d(M_{\text{symb}} - 1)$ according to

$$d(i) = w(i \bmod N_{\text{SF}}^{\text{PHICH}}) \cdot (1 - 2c(i)) \cdot z(\lfloor i / N_{\text{SF}}^{\text{PHICH}} \rfloor)$$

where

$$i = 0, \dots, M_{\text{symb}} - 1$$

$$M_{\text{symb}} = N_{\text{SF}}^{\text{PHICH}} \cdot M_s$$

$$N_{\text{SF}}^{\text{PHICH}} = \begin{cases} 4 & \text{normal cyclic prefix} \\ 2 & \text{extended cyclic prefix} \end{cases}$$

and $c(i)$ is a cell-specific scrambling sequence generated according to Section 7.2. The scrambling sequence generator shall be initialised with $c_{\text{init}} = (\lfloor n_s/2 \rfloor + 1) \cdot (2N_{\text{ID}}^{\text{cell}} + 1) \cdot 2^9 + N_{\text{ID}}^{\text{cell}}$ at the start of each subframe.

The sequence $[w(0) \ \dots \ w(N_{\text{SF}}^{\text{PHICH}} - 1)]$ is given by Table 6.9.1-2 where the sequence index $n_{\text{PHICH}}^{\text{seq}}$ corresponds to the PHICH number within the PHICH group.

Table 6.9.1-2: Orthogonal sequences $[w(0) \ \dots \ w(N_{\text{SF}}^{\text{PHICH}} - 1)]$ for PHICH.

Sequence index $n_{\text{PHICH}}^{\text{seq}}$	Orthogonal sequence	
	Normal cyclic prefix $N_{\text{SF}}^{\text{PHICH}} = 4$	Extended cyclic prefix $N_{\text{SF}}^{\text{PHICH}} = 2$
0	$[+1 \ +1 \ +1 \ +1]$	$[+1 \ +1]$
1	$[+1 \ -1 \ +1 \ -1]$	$[+1 \ -1]$
2	$[+1 \ +1 \ -1 \ -1]$	$[+j \ +j]$
3	$[+1 \ -1 \ -1 \ +1]$	$[+j \ -j]$
4	$[+j \ +j \ +j \ +j]$	-
5	$[+j \ -j \ +j \ -j]$	-
6	$[+j \ +j \ -j \ -j]$	-
7	$[+j \ -j \ -j \ +j]$	-

6.9.2 Resource group alignment, layer mapping and precoding

The block of symbols $d(0), \dots, d(M_{\text{symb}} - 1)$ should be first aligned with resource element group size, resulting in a block of symbols $d^{(0)}(0), \dots, d^{(0)}(c \cdot M_{\text{symb}} - 1)$, where $c = 1$ for normal cyclic prefix; and $c = 2$ for extended cyclic prefix.

For normal cyclic prefix, $d^{(0)}(i) = d(i)$, for $i = 0, \dots, M_{\text{symb}} - 1$.

For extended cyclic prefix,

$$\begin{bmatrix} d^{(0)}(4i) & d^{(0)}(4i+1) & d^{(0)}(4i+2) & d^{(0)}(4i+3) \end{bmatrix}^T = \begin{cases} [d(2i) & d(2i+1) & 0 & 0]^T & n_{\text{PHICH}}^{\text{group}} \bmod 2 = 0 \\ [0 & 0 & d(2i) & d(2i+1)]^T & n_{\text{PHICH}}^{\text{group}} \bmod 2 = 1 \end{cases}$$

for $i = 0, \dots, (M_{\text{symb}}/2) - 1$.

The block of symbols $d^{(0)}(0), \dots, d^{(0)}(c \cdot M_{\text{symb}} - 1)$ shall be mapped to layers and precoded, resulting in a block of vectors $y(i) = [y^{(0)}(i) \ \dots \ y^{(P-1)}(i)]^T$, $i = 0, \dots, c \cdot M_{\text{symb}} - 1$, where $y^{(p)}(i)$ represents the signal for antenna port p , $p = 0, \dots, P - 1$ and the number of cell-specific reference signals $P \in \{1, 2, 4\}$. The layer mapping and precoding operation depends on the cyclic prefix length and the number of antenna ports used for transmission of the PHICH. The PHICH shall be transmitted on the same set of antenna ports as the PBCH.

For transmission on a single antenna port, $P = 1$, layer mapping and precoding are defined by Sections 6.3.3.1 and 6.3.4.1, respectively, with $M_{\text{symb}}^{(0)} = c \cdot M_{\text{symb}}$.

For transmission on two antenna ports, $P = 2$, layer mapping and precoding are defined by Sections 6.3.3.3 and 6.3.4.3, respectively, with $M_{\text{symb}}^{(0)} = c \cdot M_{\text{symb}}$.

For transmission on four antenna ports, $P = 4$, layer mapping is defined by Section 6.3.3.3 with $M_{\text{symb}}^{(0)} = c \cdot M_{\text{symb}}$ and precoding by

$$\begin{bmatrix} y^{(0)}(4i) \\ y^{(1)}(4i) \\ y^{(2)}(4i) \\ y^{(3)}(4i) \\ y^{(0)}(4i+1) \\ y^{(1)}(4i+1) \\ y^{(2)}(4i+1) \\ y^{(3)}(4i+1) \\ y^{(0)}(4i+2) \\ y^{(1)}(4i+2) \\ y^{(2)}(4i+2) \\ y^{(3)}(4i+2) \\ y^{(0)}(4i+3) \\ y^{(1)}(4i+3) \\ y^{(2)}(4i+3) \\ y^{(3)}(4i+3) \end{bmatrix} = \frac{1}{\sqrt{2}} \begin{bmatrix} 1 & 0 & 0 & 0 & j & 0 & 0 & 0 \\ 0 & 0 & 0 & 0 & 0 & 0 & 0 & 0 \\ 0 & -1 & 0 & 0 & 0 & j & 0 & 0 \\ 0 & 0 & 0 & 0 & 0 & 0 & 0 & 0 \\ 0 & 1 & 0 & 0 & 0 & j & 0 & 0 \\ 0 & 0 & 0 & 0 & 0 & 0 & 0 & 0 \\ 1 & 0 & 0 & 0 & -j & 0 & 0 & 0 \\ 0 & 0 & 0 & 0 & 0 & 0 & 0 & 0 \\ 0 & 0 & 1 & 0 & 0 & 0 & j & 0 \\ 0 & 0 & 0 & 0 & 0 & 0 & 0 & 0 \\ 0 & 0 & 0 & -1 & 0 & 0 & 0 & j \\ 0 & 0 & 0 & 0 & 0 & 0 & 0 & 0 \\ 0 & 0 & 0 & 1 & 0 & 0 & 0 & j \\ 0 & 0 & 0 & 0 & 0 & 0 & 0 & 0 \\ 0 & 0 & 1 & 0 & 0 & 0 & -j & 0 \\ 0 & 0 & 0 & 0 & 0 & 0 & 0 & 0 \end{bmatrix} \begin{bmatrix} \text{Re}(x^{(0)}(i)) \\ \text{Re}(x^{(1)}(i)) \\ \text{Re}(x^{(2)}(i)) \\ \text{Re}(x^{(3)}(i)) \\ \text{Im}(x^{(0)}(i)) \\ \text{Im}(x^{(1)}(i)) \\ \text{Im}(x^{(2)}(i)) \\ \text{Im}(x^{(3)}(i)) \end{bmatrix}$$

if $(i + n_{\text{PHICH}}^{\text{group}}) \bmod 2 = 0$ for normal cyclic prefix, or $(i + \lfloor n_{\text{PHICH}}^{\text{group}}/2 \rfloor) \bmod 2 = 0$ for extended cyclic prefix, where $n_{\text{PHICH}}^{\text{group}}$ is the PHICH group number and $i = 0,1,2$, and by

$$\begin{bmatrix} y^{(0)}(4i) \\ y^{(1)}(4i) \\ y^{(2)}(4i) \\ y^{(3)}(4i) \\ y^{(0)}(4i+1) \\ y^{(1)}(4i+1) \\ y^{(2)}(4i+1) \\ y^{(3)}(4i+1) \\ y^{(0)}(4i+2) \\ y^{(1)}(4i+2) \\ y^{(2)}(4i+2) \\ y^{(3)}(4i+2) \\ y^{(0)}(4i+3) \\ y^{(1)}(4i+3) \\ y^{(2)}(4i+3) \\ y^{(3)}(4i+3) \end{bmatrix} = \frac{1}{\sqrt{2}} \begin{bmatrix} 0 & 0 & 0 & 0 & 0 & 0 & 0 & 0 \\ 1 & 0 & 0 & 0 & j & 0 & 0 & 0 \\ 0 & 0 & 0 & 0 & 0 & 0 & 0 & 0 \\ 0 & -1 & 0 & 0 & 0 & j & 0 & 0 \\ 0 & 0 & 0 & 0 & 0 & 0 & 0 & 0 \\ 0 & 1 & 0 & 0 & 0 & j & 0 & 0 \\ 0 & 0 & 0 & 0 & 0 & 0 & 0 & 0 \\ 1 & 0 & 0 & 0 & -j & 0 & 0 & 0 \\ 0 & 0 & 0 & 0 & 0 & 0 & 0 & 0 \\ 0 & 0 & 1 & 0 & 0 & 0 & j & 0 \\ 0 & 0 & 0 & 0 & 0 & 0 & 0 & 0 \\ 0 & 0 & 0 & -1 & 0 & 0 & 0 & j \\ 0 & 0 & 0 & 0 & 0 & 0 & 0 & 0 \\ 0 & 0 & 0 & 1 & 0 & 0 & 0 & j \\ 0 & 0 & 0 & 0 & 0 & 0 & 0 & 0 \\ 0 & 0 & 1 & 0 & 0 & 0 & -j & 0 \end{bmatrix} \begin{bmatrix} \text{Re}(x^{(0)}(i)) \\ \text{Re}(x^{(1)}(i)) \\ \text{Re}(x^{(2)}(i)) \\ \text{Re}(x^{(3)}(i)) \\ \text{Im}(x^{(0)}(i)) \\ \text{Im}(x^{(1)}(i)) \\ \text{Im}(x^{(2)}(i)) \\ \text{Im}(x^{(3)}(i)) \end{bmatrix}$$

otherwise for $i = 0,1,2$.

6.9.3 Mapping to resource elements

The sequence $\bar{y}^{(p)}(0), \dots, \bar{y}^{(p)}(M_{\text{sy mb}}^{(0)} - 1)$ for each of the PHICH groups is defined by

$$\bar{y}^{(p)}(n) = \sum y_i^{(p)}(n)$$

where the sum is over all PHICHs in the PHICH group and $y_i^{(p)}(n)$ represents the symbol sequence from the i :th PHICH in the PHICH group.

PHICH groups are mapped to PHICH mapping units.

For normal cyclic prefix, the mapping of PHICH group m to PHICH mapping unit m' is defined by

$$\tilde{y}_{m'}^{(p)}(n) = \bar{y}_m^{(p)}(n)$$

where

$$m' = m = \begin{cases} 0, 1, \dots, N_{\text{PHICH}}^{\text{group}} - 1 & \text{for frame structure type 1} \\ 0, 1, \dots, m_i \cdot N_{\text{PHICH}}^{\text{group}} - 1 & \text{for frame structure type 2} \end{cases},$$

and where m_i is given by Table 6.9-1.

For extended cyclic prefix, the mapping of PHICH group m and $m+1$ to PHICH mapping unit m' is defined by

$$\tilde{y}_{m'}^{(p)}(n) = \bar{y}_m^{(p)}(n) + \bar{y}_{m+1}^{(p)}(n)$$

where

$$m' = m / 2$$

$$m = \begin{cases} 0, 2, \dots, N_{\text{PHICH}}^{\text{group}} - 2 & \text{for frame structure type 1} \\ 0, 2, \dots, m_i \cdot N_{\text{PHICH}}^{\text{group}} - 2 & \text{for frame structure type 2} \end{cases}$$

and where m_i is given by Table 6.9-1.

Let $z^{(p)}(i) = \langle \tilde{y}^{(p)}(4i), \tilde{y}^{(p)}(4i+1), \tilde{y}^{(p)}(4i+2), \tilde{y}^{(p)}(4i+3) \rangle$, $i = 0, 1, 2$ denote symbol quadruplet i for antenna port p .

Mapping to resource elements is defined in terms of symbol quadruplets according to steps 1–10 below:

- 1) For each value of I'
- 2) Let n_r denote the number of resource element groups not assigned to PCFICH in OFDM symbol I'
- 3) Number the resource-element groups not assigned to PCFICH in OFDM symbol I' from 0 to $n_r - 1$, starting from the resource-element group with the lowest frequency-domain index.
- 4) Initialize $m' = 0$ (PHICH mapping unit number)
- 5) For each value of $i = 0, 1, 2$
- 6) Symbol-quadruplet $z^{(p)}(i)$ from PHICH mapping unit m' is mapped to the resource-element group represented by $(k', l')_i$ as defined in Section 6.2.4 where the indices k'_i and l'_i are given by steps 7 and 8 below:
- 7) The time-domain index l'_i is given by

$$l'_i = \begin{cases} 0 & \text{normal PHICH duration, all subframes} \\ \lfloor m'/2 \rfloor + i + 1 \pmod 2 & \text{extended PHICH duration, MBSFN subframes} \\ \lfloor m'/2 \rfloor + i + 1 \pmod 2 & \text{extended PHICH duration, subframe 1 and 6 in frame structure type 2} \\ i & \text{otherwise} \end{cases}$$

- 8) Set the frequency-domain index k'_i to the resource-element group assigned the number \bar{n}_i in step 3 above, where \bar{n}_i is given by

$$\bar{n}_i = \begin{cases} \left(\lfloor N_{\text{ID}}^{\text{cell}} \cdot n_{i'} / n_1 \rfloor + m' \right) \pmod{n_{i'}} & i = 0 \\ \left(\lfloor N_{\text{ID}}^{\text{cell}} \cdot n_{i'} / n_1 \rfloor + m' + \lfloor n_{i'} / 3 \rfloor \right) \pmod{n_{i'}} & i = 1 \\ \left(\lfloor N_{\text{ID}}^{\text{cell}} \cdot n_{i'} / n_1 \rfloor + m' + \lfloor 2n_{i'} / 3 \rfloor \right) \pmod{n_{i'}} & i = 2 \end{cases}$$

in case of extended PHICH duration in MBSFN subframes, or extended PHICH duration in subframes 1 and 6 for frame structure type 2 and by

$$\bar{n}_i = \begin{cases} \left(\lfloor N_{\text{ID}}^{\text{cell}} \cdot n_{i'} / n_0 \rfloor + m' \right) \pmod{n_{i'}} & i = 0 \\ \left(\lfloor N_{\text{ID}}^{\text{cell}} \cdot n_{i'} / n_0 \rfloor + m' + \lfloor n_{i'} / 3 \rfloor \right) \pmod{n_{i'}} & i = 1 \\ \left(\lfloor N_{\text{ID}}^{\text{cell}} \cdot n_{i'} / n_0 \rfloor + m' + \lfloor 2n_{i'} / 3 \rfloor \right) \pmod{n_{i'}} & i = 2 \end{cases}$$

otherwise.

- 9) Increase m' by 1.

- 10) Repeat from step 5 until all PHICH mapping units have been assigned.

The PHICH duration is configurable by higher layers according to Table 6.9.3-1.

Table 6.9.3-1: PHICH duration in MBSFN and non-MBSFN subframes.

PHICH duration	Non-MBSFN subframes		MBSFN subframes on a carrier supporting PDSCH
	Subframes 1 and 6 in case of frame structure type 2	All other cases	
Normal	1	1	1
Extended	2	3	2

6.10 Reference signals

Six types of downlink reference signals are defined:

- Cell-specific reference signals (CRS)
- MBSFN reference signals
- UE-specific reference signals (DM-RS) associated with PDSCH
- Demodulation reference signals (DM-RS) associated with EPDCCH
- Positioning reference signals (PRS)
- CSI reference signals (CSI-RS)

There is one reference signal transmitted per downlink antenna port.

6.10.1 Cell-specific reference signals

Cell-specific reference signals shall be transmitted in all downlink subframes in a cell supporting PDSCH transmission.

Cell-specific reference signals are transmitted on one or several of antenna ports 0 to 3.

Cell-specific reference signals are defined for $\Delta f = 15$ kHz only.

6.10.1.1 Sequence generation

The reference-signal sequence $r_{l,n_s}(m)$ is defined by

$$r_{l,n_s}(m) = \frac{1}{\sqrt{2}}(1 - 2 \cdot c(2m)) + j \frac{1}{\sqrt{2}}(1 - 2 \cdot c(2m+1)), \quad m = 0, 1, \dots, 2N_{\text{RB}}^{\text{max,DL}} - 1$$

where n_s is the slot number within a radio frame and l is the OFDM symbol number within the slot. The pseudo-random sequence $c(i)$ is defined in Section 7.2. The pseudo-random sequence generator shall be initialised with $c_{\text{init}} = 2^{10} \cdot (7 \cdot (n_s + 1) + l + 1) \cdot (2 \cdot N_{\text{ID}}^{\text{cell}} + 1) + 2 \cdot N_{\text{ID}}^{\text{cell}} + N_{\text{CP}}$ at the start of each OFDM symbol where

$$N_{\text{CP}} = \begin{cases} 1 & \text{for normal CP} \\ 0 & \text{for extended CP} \end{cases}$$

6.10.1.2 Mapping to resource elements

The reference signal sequence $r_{l,n_s}(m)$ shall be mapped to complex-valued modulation symbols $a_{k,l}^{(p)}$ used as reference symbols for antenna port p in slot n_s according to

$$a_{k,l}^{(p)} = r_{l,n_s}(m')$$

where

$$\begin{aligned} k &= 6m + (v + v_{\text{shift}}) \bmod 6 \\ l &= \begin{cases} 0, N_{\text{symp}}^{\text{DL}} - 3 & \text{if } p \in \{0, 1\} \\ 1 & \text{if } p \in \{2, 3\} \end{cases} \\ m &= 0, 1, \dots, 2 \cdot N_{\text{RB}}^{\text{DL}} - 1 \\ m' &= m + N_{\text{RB}}^{\text{max,DL}} - N_{\text{RB}}^{\text{DL}} \end{aligned}$$

The variables v and v_{shift} define the position in the frequency domain for the different reference signals where v is given by

$$v = \begin{cases} 0 & \text{if } p = 0 \text{ and } l = 0 \\ 3 & \text{if } p = 0 \text{ and } l \neq 0 \\ 3 & \text{if } p = 1 \text{ and } l = 0 \\ 0 & \text{if } p = 1 \text{ and } l \neq 0 \\ 3(n_s \bmod 2) & \text{if } p = 2 \\ 3 + 3(n_s \bmod 2) & \text{if } p = 3 \end{cases}$$

The cell-specific frequency shift is given by $v_{\text{shift}} = N_{\text{ID}}^{\text{cell}} \bmod 6$.

Resource elements (k, l) used for transmission of cell-specific reference signals on any of the antenna ports in a slot shall not be used for any transmission on any other antenna port in the same slot and set to zero.

In an MBSFN subframe, cell-specific reference signals shall only be transmitted in the non-MBSFN region of the MBSFN subframe.

Figures 6.10.1.2-1 and 6.10.1.2-2 illustrate the resource elements used for reference signal transmission according to the above definition. The notation R_p is used to denote a resource element used for reference signal transmission on antenna port p .

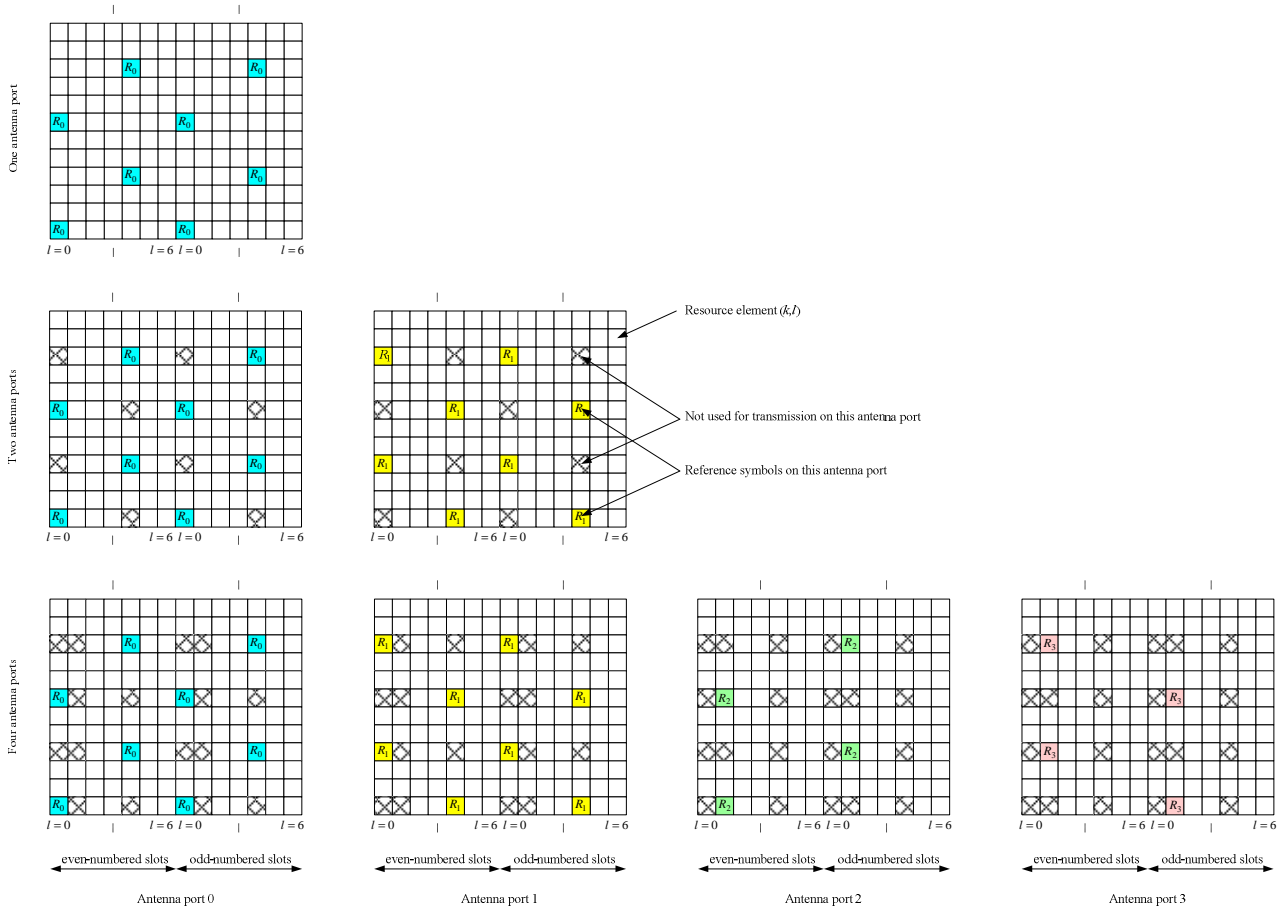

Figure 6.10.1.2-1. Mapping of downlink reference signals (normal cyclic prefix).

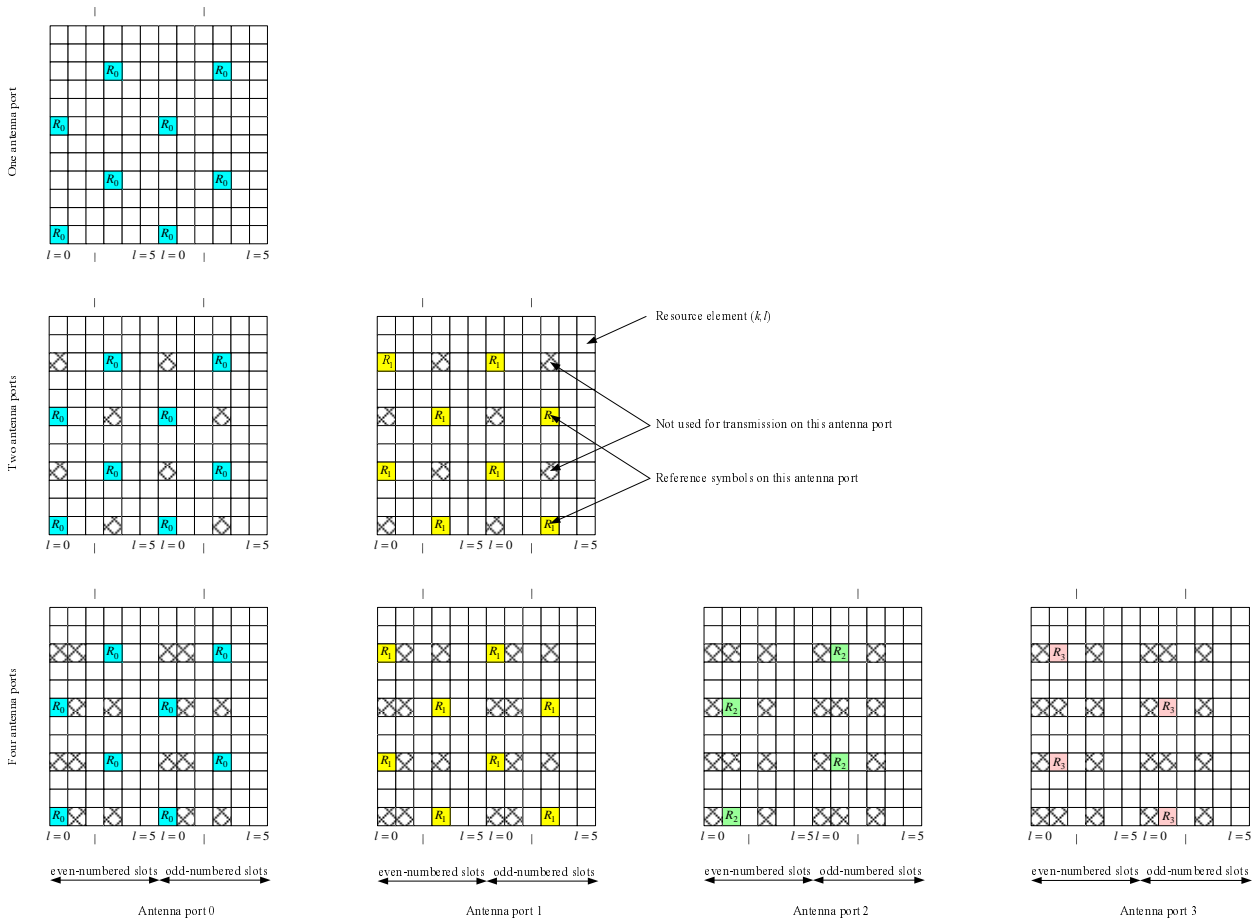

Figure 6.10.1.2-2. Mapping of downlink reference signals (extended cyclic prefix).

6.10.2 MBSFN reference signals

MBSFN reference signals shall be transmitted in the MBSFN region of MBSFN subframes only when the PMCH is transmitted. MBSFN reference signals are transmitted on antenna port 4.

MBSFN reference signals are defined for extended cyclic prefix only.

6.10.2.1 Sequence generation

The MBSFN reference-signal sequence $r_{l,n_s}(m)$ is defined by

$$r_{l,n_s}(m) = \frac{1}{\sqrt{2}}(1 - 2 \cdot c(2m)) + j \frac{1}{\sqrt{2}}(1 - 2 \cdot c(2m + 1)), \quad m = 0, 1, \dots, 6N_{RB}^{\max,DL} - 1$$

where n_s is the slot number within a radio frame and l is the OFDM symbol number within the slot. The pseudo-random sequence $c(i)$ is defined in Section 7.2. The pseudo-random sequence generator shall be initialised with $c_{init} = 2^9 \cdot (7 \cdot (n_s + 1) + l + 1) \cdot (2 \cdot N_{ID}^{MBSFN} + 1) + N_{ID}^{MBSFN}$ at the start of each OFDM symbol.

6.10.2.2 Mapping to resource elements

The reference-signal sequence $r_{l,n_s}(m')$ in OFDM symbol l shall be mapped to complex-valued modulation symbols $a_{k,l}^{(p)}$ with $p = 4$ according to

$$a_{k,l}^{(p)} = r_{l,n_s}(m')$$

where

$$k = \begin{cases} 2m & \text{if } l \neq 0 \text{ and } \Delta f = 15 \text{ kHz} \\ 2m + 1 & \text{if } l = 0 \text{ and } \Delta f = 15 \text{ kHz} \\ 4m & \text{if } l \neq 0 \text{ and } \Delta f = 7.5 \text{ kHz} \\ 4m + 2 & \text{if } l = 0 \text{ and } \Delta f = 7.5 \text{ kHz} \end{cases}$$

$$l = \begin{cases} 2 & \text{if } n_s \bmod 2 = 0 \text{ and } \Delta f = 15 \text{ kHz} \\ 0,4 & \text{if } n_s \bmod 2 = 1 \text{ and } \Delta f = 15 \text{ kHz} \\ 1 & \text{if } n_s \bmod 2 = 0 \text{ and } \Delta f = 7.5 \text{ kHz} \\ 0,2 & \text{if } n_s \bmod 2 = 1 \text{ and } \Delta f = 7.5 \text{ kHz} \end{cases}$$

$$m = 0, 1, \dots, 6N_{RB}^{DL} - 1$$

$$m' = m + 3(N_{RB}^{max,DL} - N_{RB}^{DL})$$

Figure 6.10.2.2-1 illustrates the resource elements used for MBSFN reference signal transmission in case of $\Delta f = 15 \text{ kHz}$. In case of $\Delta f = 7.5 \text{ kHz}$ for a MBSFN-dedicated cell, the MBSFN reference signal shall be mapped to resource elements according to Figure 6.10.2.2-3. The notation R_p is used to denote a resource element used for reference signal transmission on antenna port p .

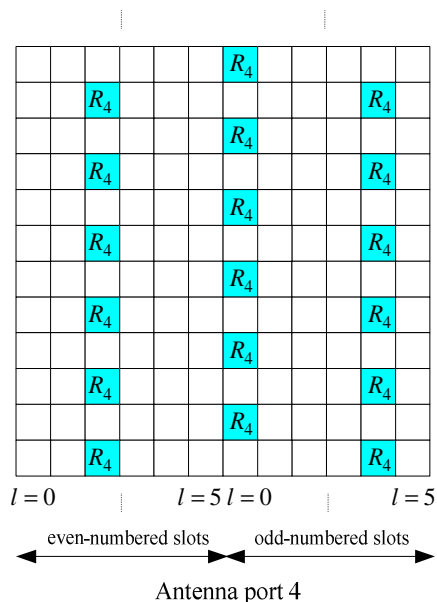

Figure 6.10.2.2-1: Mapping of MBSFN reference signals (extended cyclic prefix, $\Delta f = 15 \text{ kHz}$).

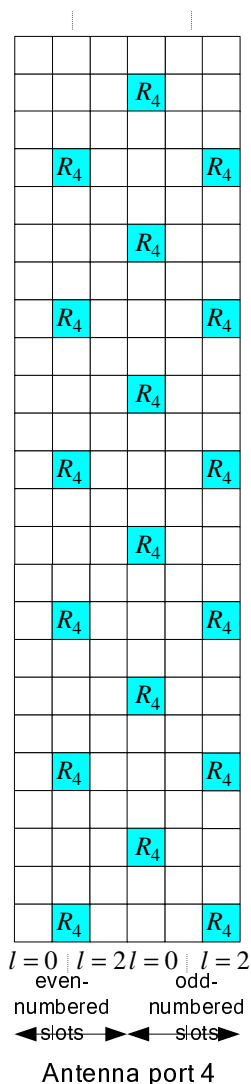

Figure 6.10.2.2-3: Mapping of MBSFN reference signals (extended cyclic prefix, $\Delta f = 7.5$ kHz).

6.10.3 UE-specific reference signals associated with PDSCH

UE-specific reference signals associated with PDSCH

- are transmitted on antenna port(s) $p = 5, p = 7, p = 8$ or $p = 7, 8, \dots, v + 6$, where v is the number of layers used for transmission of the PDSCH;
- are present and are a valid reference for PDSCH demodulation only if the PDSCH transmission is associated with the corresponding antenna port according to Section 7.1 of [4];
- are transmitted only on the physical resource blocks upon which the corresponding PDSCH is mapped.

A UE-specific reference signal associated with PDSCH is not transmitted in resource elements (k, l) in which one of the physical channels or physical signals other than the UE-specific reference signals defined in 6.1 are transmitted using resource elements with the same index pair (k, l) regardless of their antenna port p .

6.10.3.1 Sequence generation

For antenna port 5, the UE-specific reference-signal sequence $r_{n_s}(m)$ is defined by

$$r_{n_s}(m) = \frac{1}{\sqrt{2}}(1 - 2 \cdot c(2m)) + j \frac{1}{\sqrt{2}}(1 - 2 \cdot c(2m+1)), \quad m = 0, 1, \dots, 12N_{\text{RB}}^{\text{PDSCH}} - 1$$

where $N_{\text{RB}}^{\text{PDSCH}}$ denotes the bandwidth in resource blocks of the corresponding PDSCH transmission. The pseudo-random sequence $c(i)$ is defined in Section 7.2. The pseudo-random sequence generator shall be initialised with $c_{\text{init}} = (\lfloor n_s/2 \rfloor + 1) \cdot (2N_{\text{ID}}^{\text{cell}} + 1) \cdot 2^{16} + n_{\text{RNTI}}$ at the start of each subframe where n_{RNTI} is as described in Section 7.1[4].

For any of the antenna ports $p \in \{7, 8, \dots, v+6\}$, the reference-signal sequence $r(m)$ is defined by

$$r(m) = \frac{1}{\sqrt{2}}(1 - 2 \cdot c(2m)) + j \frac{1}{\sqrt{2}}(1 - 2 \cdot c(2m+1)), \quad m = \begin{cases} 0, 1, \dots, 12N_{\text{RB}}^{\text{max,DL}} - 1 & \text{normal cyclic prefix} \\ 0, 1, \dots, 16N_{\text{RB}}^{\text{max,DL}} - 1 & \text{extended cyclic prefix} \end{cases}$$

The pseudo-random sequence $c(i)$ is defined in Section 7.2. The pseudo-random sequence generator shall be initialised with

$$c_{\text{init}} = (\lfloor n_s/2 \rfloor + 1) \cdot (2n_{\text{ID}}^{(n_{\text{SCID}})} + 1) \cdot 2^{16} + n_{\text{SCID}}$$

at the start of each subframe.

The quantities $n_{\text{ID}}^{(i)}$, $i = 0, 1$, are given by

- $n_{\text{ID}}^{(i)} = N_{\text{ID}}^{\text{cell}}$ if no value for $n_{\text{ID}}^{\text{DMRS},i}$ is provided by higher layers or if DCI format 1A, 2B or 2C is used for the DCI associated with the PDSCH transmission
- $n_{\text{ID}}^{(i)} = n_{\text{ID}}^{\text{DMRS},i}$ otherwise

The value of n_{SCID} is zero unless specified otherwise. For a PDSCH transmission on ports 7 or 8, n_{SCID} is given by the DCI format 2B, 2C or 2D [3] associated with the PDSCH transmission. In the case of DCI format 2B, n_{SCID} is indicated by the scrambling identity field according to Table 6.10.3.1-1. In the case of DCI format 2C or 2D, n_{SCID} is given by Table 5.3.3.1.5C-1 in [3].

Table 6.10.3.1-1: Mapping of scrambling identity field in DCI format 2B to n_{SCID} values for antenna ports 7 and 8.

Scrambling identity field in DCI format 2B [3]	n_{SCID}
0	0
1	1

6.10.3.2 Mapping to resource elements

For antenna port 5, in a physical resource block with frequency-domain index n_{PRB} assigned for the corresponding PDSCH transmission, the reference signal sequence $r_{n_s}(m)$ shall be mapped to complex-valued modulation symbols $a_{k,l}^{(p)}$ with $p = 5$ in a subframe according to:

Normal cyclic prefix:

$$a_{k,l}^{(p)} = r_{n_s}(3 \cdot l' \cdot N_{\text{RB}}^{\text{PDSCH}} + m')$$

$$\begin{aligned}
k &= (k') \bmod N_{sc}^{RB} + N_{sc}^{RB} \cdot n_{PRB} \\
k' &= \begin{cases} 4m' + v_{\text{shift}} & \text{if } l \in \{2,3\} \\ 4m' + (2 + v_{\text{shift}}) \bmod 4 & \text{if } l \in \{5,6\} \end{cases} \\
l &= \begin{cases} 3 & l' = 0 \\ 6 & l' = 1 \\ 2 & l' = 2 \\ 5 & l' = 3 \end{cases} \\
l' &= \begin{cases} 0,1 & \text{if } n_s \bmod 2 = 0 \\ 2,3 & \text{if } n_s \bmod 2 = 1 \end{cases} \\
m' &= 0, 1, \dots, 3N_{RB}^{\text{PDSCH}} - 1
\end{aligned}$$

Extended cyclic prefix:

$$\begin{aligned}
a_{k,l}^{(p)} &= r_{n_s} (4 \cdot l' \cdot N_{RB}^{\text{PDSCH}} + m') \\
k &= (k') \bmod N_{sc}^{RB} + N_{sc}^{RB} \cdot n_{PRB} \\
k' &= \begin{cases} 3m' + v_{\text{shift}} & \text{if } l = 4 \\ 3m' + (2 + v_{\text{shift}}) \bmod 3 & \text{if } l = 1 \end{cases} \\
l &= \begin{cases} 4 & l' \in \{0,2\} \\ 1 & l' = 1 \end{cases} \\
l' &= \begin{cases} 0 & \text{if } n_s \bmod 2 = 0 \\ 1,2 & \text{if } n_s \bmod 2 = 1 \end{cases} \\
m' &= 0, 1, \dots, 4N_{RB}^{\text{PDSCH}} - 1
\end{aligned}$$

where m' is the counter of UE-specific reference signal resource elements within a respective OFDM symbol of the PDSCH transmission.

The cell-specific frequency shift is given by $v_{\text{shift}} = N_{ID}^{\text{cell}} \bmod 3$.

The mapping shall be in increasing order of the frequency-domain index n_{PRB} of the physical resource blocks assigned for the corresponding PDSCH transmission. The quantity N_{RB}^{PDSCH} denotes the bandwidth in resource blocks of the corresponding PDSCH transmission.

Figure 6.10.3.2-1 illustrates the resource elements used for UE-specific reference signals for normal cyclic prefix for antenna port 5.

Figure 6.10.3.2-2 illustrates the resource elements used for UE-specific reference signals for extended cyclic prefix for antenna port 5.

The notation R_p is used to denote a resource element used for reference signal transmission on antenna port p .

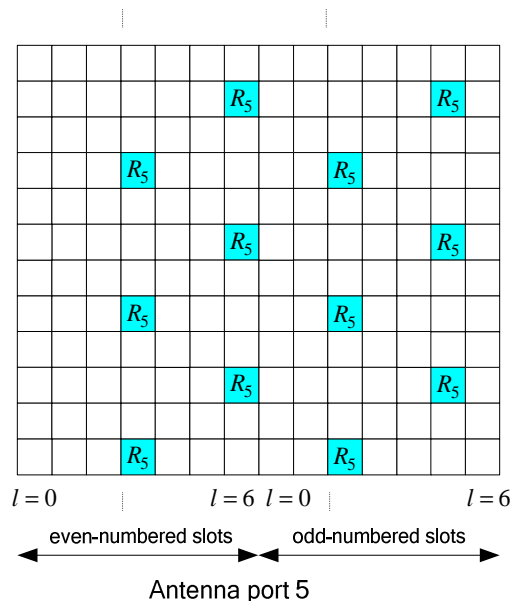

Figure 6.10.3.2-1: Mapping of UE-specific reference signals, antenna port 5 (normal cyclic prefix).

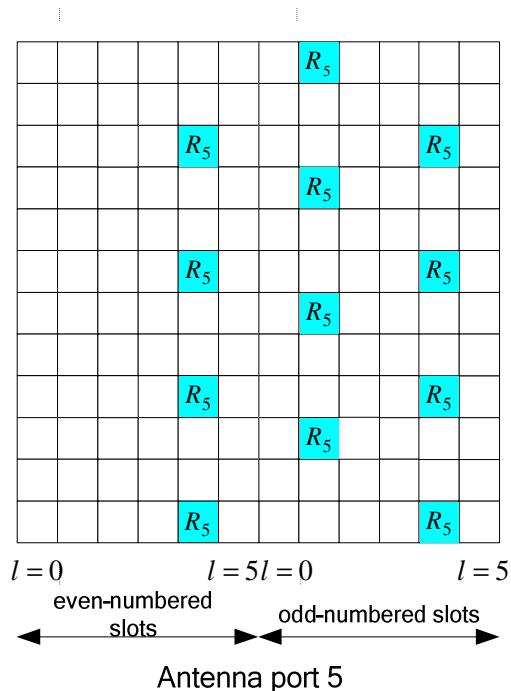

Figure 6.10.3.2-2: Mapping of UE-specific reference signals, antenna port 5 (extended cyclic prefix).

For antenna ports $p = 7$, $p = 8$ or $p = 7, 8, \dots, v + 6$, in a physical resource block with frequency-domain index n_{PRB} assigned for the corresponding PDSCH transmission, a part of the reference signal sequence $r(m)$ shall be mapped to complex-valued modulation symbols $a_{k,l}^{(p)}$ in a subframe according to

Normal cyclic prefix:

$$a_{k,l}^{(p)} = w_p(l') \cdot r(3 \cdot l' \cdot N_{\text{RB}}^{\text{max,DL}} + 3 \cdot n_{\text{PRB}} + m')$$

where

$$w_p(i) = \begin{cases} \bar{w}_p(i) & (m' + n_{\text{PRB}}) \bmod 2 = 0 \\ \bar{w}_p(3-i) & (m' + n_{\text{PRB}}) \bmod 2 = 1 \end{cases}$$

$$k = 5m' + N_{\text{sc}}^{\text{RB}} n_{\text{PRB}} + k'$$

$$k' = \begin{cases} 1 & p \in \{7, 8, 11, 13\} \\ 0 & p \in \{9, 10, 12, 14\} \end{cases}$$

$$l = \begin{cases} l' \bmod 2 + 2 & \text{if in a special subframe with configuration 3, 4, 8 or 9 (see Table 4.2-1)} \\ l' \bmod 2 + 2 + 3 \lfloor l'/2 \rfloor & \text{if in a special subframe with configuration 1, 2, 6, or 7 (see Table 4.2-1)} \\ l' \bmod 2 + 5 & \text{if not in a special subframe} \end{cases}$$

$$l' = \begin{cases} 0, 1, 2, 3 & \text{if } n_s \bmod 2 = 0 \text{ and in a special subframe with configuration 1, 2, 6, or 7 (see Table 4.2-1)} \\ 0, 1 & \text{if } n_s \bmod 2 = 0 \text{ and not in special subframe with configuration 1, 2, 6, or 7 (see Table 4.2-1)} \\ 2, 3 & \text{if } n_s \bmod 2 = 1 \text{ and not in special subframe with configuration 1, 2, 6, or 7 (see Table 4.2-1)} \end{cases}$$

$$m' = 0, 1, 2$$

The sequence $\bar{w}_p(i)$ is given by Table 6.10.3.2-1.

Table 6.10.3.2-1: The sequence $\bar{w}_p(i)$ for normal cyclic prefix.

Antenna port p	$\begin{bmatrix} \bar{w}_p(0) & \bar{w}_p(1) & \bar{w}_p(2) & \bar{w}_p(3) \end{bmatrix}$
7	$\begin{bmatrix} +1 & +1 & +1 & +1 \end{bmatrix}$
8	$\begin{bmatrix} +1 & -1 & +1 & -1 \end{bmatrix}$
9	$\begin{bmatrix} +1 & +1 & +1 & +1 \end{bmatrix}$
10	$\begin{bmatrix} +1 & -1 & +1 & -1 \end{bmatrix}$
11	$\begin{bmatrix} +1 & +1 & -1 & -1 \end{bmatrix}$
12	$\begin{bmatrix} -1 & -1 & +1 & +1 \end{bmatrix}$
13	$\begin{bmatrix} +1 & -1 & -1 & +1 \end{bmatrix}$
14	$\begin{bmatrix} -1 & +1 & +1 & -1 \end{bmatrix}$

Extended cyclic prefix:

$$a_{k,l}^{(p)} = w_p(l' \bmod 2) \cdot r(4 \cdot l' \cdot N_{\text{RB}}^{\text{max,DL}} + 4 \cdot n_{\text{PRB}} + m')$$

where

$$w_p(i) = \begin{cases} \bar{w}_p(i) & m' \bmod 2 = 0 \\ \bar{w}_p(1-i) & m' \bmod 2 = 1 \end{cases}$$

$$k = 3m' + N_{\text{sc}}^{\text{RB}} n_{\text{PRB}} + k'$$

$$k' = \begin{cases} 1 & \text{if } n_s \bmod 2 = 0 \text{ and } p \in \{7, 8\} \\ 2 & \text{if } n_s \bmod 2 = 1 \text{ and } p \in \{7, 8\} \end{cases}$$

$$l = l' \bmod 2 + 4$$

$$l' = \begin{cases} 0, 1 & \text{if } n_s \bmod 2 = 0 \text{ and in a special subframe with configuration 1, 2, 3, 5 or 6 (see Table 4.2-1)} \\ 0, 1 & \text{if } n_s \bmod 2 = 0 \text{ and not in a special subframe} \\ 2, 3 & \text{if } n_s \bmod 2 = 1 \text{ and not in a special subframe} \end{cases}$$

$$m' = 0, 1, 2, 3$$

The sequence $\bar{w}_p(i)$ is given by Table 6.10.3.2-2.

Table 6.10.3.2-2: The sequence $\overline{w}_p(i)$ for extended cyclic prefix.

Antenna port p	$\left[\overline{w}_p(0) \quad \overline{w}_p(1) \right]$
7	$\left[+1 \quad +1 \right]$
8	$\left[-1 \quad +1 \right]$

For extended cyclic prefix, UE-specific reference signals are not supported on antenna ports 9 to 14.

Resource elements (k, l) used for transmission of UE-specific reference signals to one UE on any of the antenna ports in the set S , where $S = \{7,8,11,13\}$ or $S = \{9,10,12,14\}$ shall

- not be used for transmission of PDSCH on any antenna port in the same slot, and
- not be used for UE-specific reference signals to the same UE on any antenna port other than those in S in the same slot.

Figure 6.10.3.2-3 illustrates the resource elements used for UE-specific reference signals for normal cyclic prefix for antenna ports 7, 8, 9 and 10. Figure 6.10.3.2-4 illustrates the resource elements used for UE-specific reference signals for extended cyclic prefix for antenna ports 7, 8.

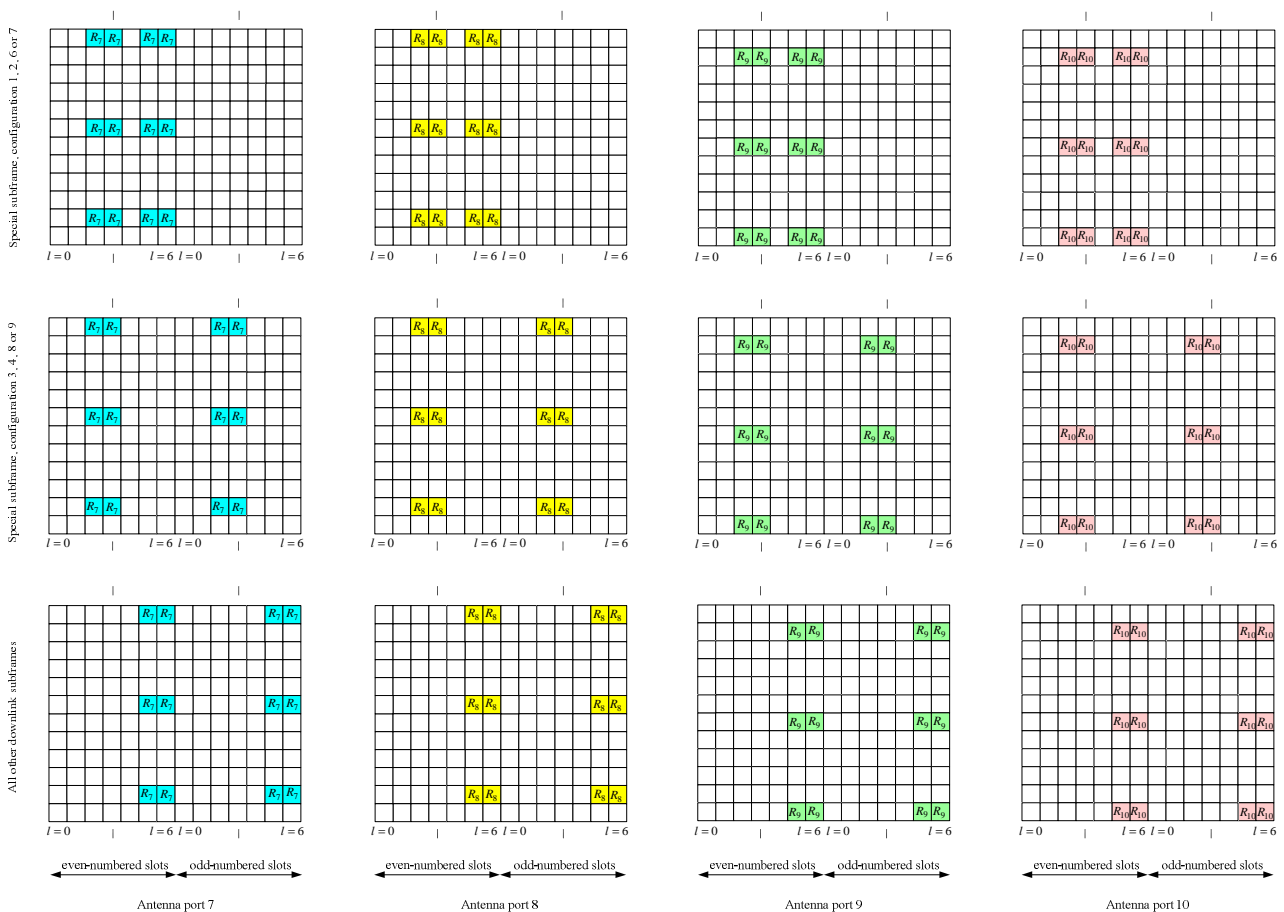

Figure 6.10.3.2-3: Mapping of UE-specific reference signals, antenna ports 7, 8, 9 and 10 (normal cyclic prefix).

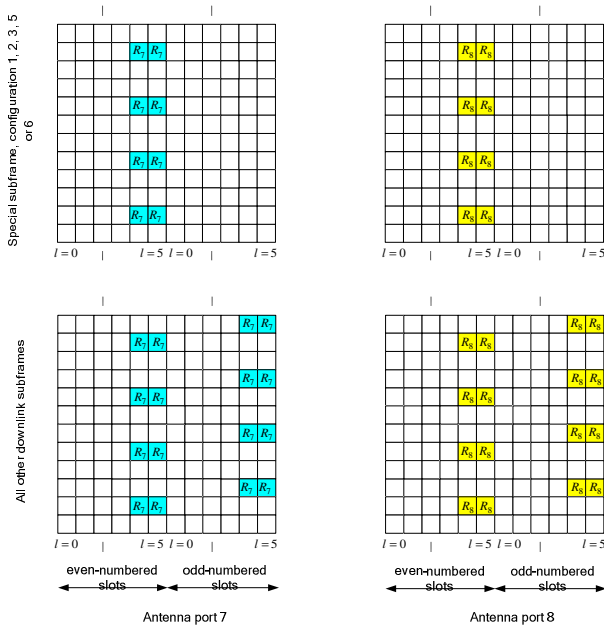

Figure 6.10.3.2-4: Mapping of UE-specific reference signals, antenna ports 7 and 8 (extended cyclic prefix).

6.10.3A Demodulation reference signals associated with EPDCCH

The demodulation reference signal associated with EPDCCH

- is transmitted on the same antenna port $p \in \{107,108,109,110\}$ as the associated EPDCCH physical resource;
- is present and is a valid reference for EPDCCH demodulation only if the EPDCCH transmission is associated with the corresponding antenna port;
- is transmitted only on the physical resource blocks upon which the corresponding EPDCCH is mapped.

A demodulation reference signal associated with EPDCCH is not transmitted in resource elements (k, l) in which one of the physical channels or physical signals other than the demodulation reference signals defined in 6.1 are transmitted using resource elements with the same index pair (k, l) regardless of their antenna port p .

6.10.3A.1 Sequence generation

For any of the antenna ports $p \in \{107,108,109,110\}$, the reference-signal sequence $r(m)$ is defined by

$$r(m) = \frac{1}{\sqrt{2}}(1 - 2 \cdot c(2m)) + j \frac{1}{\sqrt{2}}(1 - 2 \cdot c(2m + 1)), \quad m = \begin{cases} 0, 1, \dots, 12N_{RB}^{\max, DL} - 1 & \text{normal cyclic prefix} \\ 0, 1, \dots, 16N_{RB}^{\max, DL} - 1 & \text{extended cyclic prefix} \end{cases}$$

The pseudo-random sequence $c(n)$ is defined in Section 7.2. The pseudo-random sequence generator shall be initialised with

$$c_{\text{init}} = (\lfloor n_s / 2 \rfloor + 1) \cdot (2n_{\text{ID}, i}^{\text{EPDCCH}} + 1) \cdot 2^{16} + n_{\text{SCID}}^{\text{EPDCCH}}$$

at the start of each subframe where $n_{\text{SCID}}^{\text{EPDCCH}} = 2$ and $n_{\text{ID}, i}^{\text{EPDCCH}}$ is configured by higher layers. The EPDCCH set to which the EPDCCH associated with the demodulation reference signal belong is denoted $i \in \{0, 1\}$.

6.10.3A.2 Mapping to resource elements

For the antenna port $p \in \{107,108,109,110\}$ in a physical resource block n_{PRB} assigned for the associated EPDCCH, a part of the reference signal sequence $r(m)$ shall be mapped to complex-valued modulation symbols $a_{k,l}^{(p)}$ in a subframe according to

Normal cyclic prefix:

$$a_{k,l}^{(p)} = w_p(l') \cdot r(3 \cdot l' \cdot N_{\text{RB}}^{\text{max,DL}} + 3 \cdot n_{\text{PRB}} + m')$$

where

$$w_p(i) = \begin{cases} \bar{w}_p(i) & (m' + n_{\text{PRB}}) \bmod 2 = 0 \\ \bar{w}_p(3-i) & (m' + n_{\text{PRB}}) \bmod 2 = 1 \end{cases}$$

$$k = 5m' + N_{\text{sc}}^{\text{RB}} n_{\text{PRB}} + k'$$

$$k' = \begin{cases} 1 & p \in \{107,108\} \\ 0 & p \in \{109,110\} \end{cases}$$

$$l = \begin{cases} l' \bmod 2 + 2 & \text{if in a special subframe with configuration 3, 4, 8 or 9 (see Table 4.2-1)} \\ l' \bmod 2 + 2 + 3 \lfloor l'/2 \rfloor & \text{if in a special subframe with configuration 1, 2, 6, or 7 (see Table 4.2-1)} \\ l' \bmod 2 + 5 & \text{if not in a special subframe} \end{cases}$$

$$l' = \begin{cases} 0,1,2,3 & \text{if } n_s \bmod 2 = 0 \text{ and in a special subframe with configuration 1, 2, 6, or 7 (see Table 4.2-1)} \\ 0,1 & \text{if } n_s \bmod 2 = 0 \text{ and not in special subframe with configuration 1, 2, 6, or 7 (see Table 4.2-1)} \\ 2,3 & \text{if } n_s \bmod 2 = 1 \text{ and not in special subframe with configuration 1, 2, 6, or 7 (see Table 4.2-1)} \end{cases}$$

$$m' = 0,1,2$$

The sequence $\bar{w}_p(i)$ is given by Table 6.10.3A.2-1.

Table 6.10.3A.2-1: The sequence $\bar{w}_p(i)$ for normal cyclic prefix.

Antenna port p	$\begin{bmatrix} \bar{w}_p(0) & \bar{w}_p(1) & \bar{w}_p(2) & \bar{w}_p(3) \end{bmatrix}$
107	$\begin{bmatrix} +1 & +1 & +1 & +1 \end{bmatrix}$
108	$\begin{bmatrix} +1 & -1 & +1 & -1 \end{bmatrix}$
109	$\begin{bmatrix} +1 & +1 & +1 & +1 \end{bmatrix}$
110	$\begin{bmatrix} +1 & -1 & +1 & -1 \end{bmatrix}$

Extended cyclic prefix:

$$a_{k,l}^{(p)} = w_p(l' \bmod 2) \cdot r(4 \cdot l' \cdot N_{\text{RB}}^{\text{max,DL}} + 4 \cdot n_{\text{PRB}} + m')$$

where

$$w_p(i) = \begin{cases} \bar{w}_p(i) & m' \bmod 2 = 0 \\ \bar{w}_p(1-i) & m' \bmod 2 = 1 \end{cases}$$

$$k = 3m' + N_{\text{sc}}^{\text{RB}} n_{\text{PRB}} + k'$$

$$k' = \begin{cases} 1 & \text{if } n_s \bmod 2 = 0 \text{ and } p \in \{107,108\} \\ 2 & \text{if } n_s \bmod 2 = 1 \text{ and } p \in \{107,108\} \end{cases}$$

$$l = l' \bmod 2 + 4$$

$$l' = \begin{cases} 0,1 & \text{if } n_s \bmod 2 = 0 \text{ and in a special subframe with configuration 1, 2, 3, 5 or 6 (see Table 4.2-1)} \\ 0,1 & \text{if } n_s \bmod 2 = 0 \text{ and not in a special subframe} \\ 2,3 & \text{if } n_s \bmod 2 = 1 \text{ and not in a special subframe} \end{cases}$$

$$m' = 0,1,2,3$$

The sequence $\bar{w}_p(i)$ is given by Table 6.10.3A.2-2.

Table 6.10.3A.2-2: The sequence $\overline{w}_p(i)$ for extended cyclic prefix.

Antenna port p	$\left[\overline{w}_p(0) \quad \overline{w}_p(1) \right]$
107	$\left[+1 \quad +1 \right]$
108	$\left[-1 \quad +1 \right]$

For extended cyclic prefix, demodulation reference signals are not supported on antenna ports 109 to 110.

Resource elements (k, l) used for transmission of demodulation reference signals to one UE on any of the antenna ports in the set S , where $S = \{107, 108\}$ or $S = \{109, 110\}$ shall

- not be used for transmission of EPDCCH on any antenna port in the same slot, and
- not be used for demodulation reference signals to the same UE on any antenna port other than those in S in the same slot.

Replacing antenna port numbers 7 – 10 by 107 – 110 in Figure 6.10.3.2-3 provides an illustration of the resource elements used for demodulation reference signals associated with EPDCCH for normal cyclic prefix. Replacing antenna port numbers 7 – 8 by 107 – 108 in Figure 6.10.3.2-4 provides an illustration of the resource elements used for demodulation reference signals associated with EPDCCH for extended cyclic prefix.

6.10.4 Positioning reference signals

Positioning reference signals shall only be transmitted in resource blocks in downlink subframes configured for positioning reference signal transmission. If both normal and MBSFN subframes are configured as positioning subframes within a cell, the OFDM symbols in a MBSFN subframe configured for positioning reference signal transmission shall use the same cyclic prefix as used for subframe #0. If only MBSFN subframes are configured as positioning subframes within a cell, the OFDM symbols configured for positioning reference signals in the MBSFN region of these subframes shall use extended cyclic prefix length. In a subframe configured for positioning reference signal transmission, the starting positions of the OFDM symbols configured for positioning reference signal transmission shall be identical to those in a subframe in which all OFDM symbols have the same cyclic prefix length as the OFDM symbols configured for positioning reference signal transmission.

Positioning reference signals are transmitted on antenna port 6.

The positioning reference signals shall not be mapped to resource elements (k, l) allocated to PBCH, PSS or SSS regardless of their antenna port p .

Positioning reference signals are defined for $\Delta f = 15$ kHz only.

6.10.4.1 Sequence generation

The reference-signal sequence $r_{l, n_s}(m)$ is defined by

$$r_{l, n_s}(m) = \frac{1}{\sqrt{2}}(1 - 2 \cdot c(2m)) + j \frac{1}{\sqrt{2}}(1 - 2 \cdot c(2m+1)), \quad m = 0, 1, \dots, 2N_{\text{RB}}^{\text{max, DL}} - 1$$

where n_s is the slot number within a radio frame, l is the OFDM symbol number within the slot. The pseudo-random sequence $c(i)$ is defined in Section 7.2. The pseudo-random sequence generator shall be initialised with $c_{\text{init}} = 2^{10} \cdot (7 \cdot (n_s + 1) + l + 1) \cdot (2 \cdot N_{\text{ID}}^{\text{cell}} + 1) + 2 \cdot N_{\text{ID}}^{\text{cell}} + N_{\text{CP}}$ at the start of each OFDM symbol where

$$N_{\text{CP}} = \begin{cases} 1 & \text{for normal CP} \\ 0 & \text{for extended CP} \end{cases}$$

6.10.4.2 Mapping to resource elements

The reference signal sequence $r_{l,n_s}(m)$ shall be mapped to complex-valued modulation symbols $a_{k,l}^{(p)}$ used as reference signal for antenna port $p = 6$ in slot n_s according to

$$a_{k,l}^{(p)} = r_{l,n_s}(m')$$

where

Normal cyclic prefix:

$$k = 6(m + N_{RB}^{DL} - N_{RB}^{PRS}) + (6 - l + v_{\text{shift}}) \bmod 6$$

$$l = \begin{cases} 3,5,6 & \text{if } n_s \bmod 2 = 0 \\ 1,2,3,5,6 & \text{if } n_s \bmod 2 = 1 \text{ and (1 or 2 PBCH antenna ports)} \\ 2,3,5,6 & \text{if } n_s \bmod 2 = 1 \text{ and (4 PBCH antenna ports)} \end{cases}$$

$$m = 0,1,\dots,2 \cdot N_{RB}^{PRS} - 1$$

$$m' = m + N_{RB}^{\text{max,DL}} - N_{RB}^{PRS}$$

Extended cyclic prefix:

$$k = 6(m + N_{RB}^{DL} - N_{RB}^{PRS}) + (5 - l + v_{\text{shift}}) \bmod 6$$

$$l = \begin{cases} 4,5 & \text{if } n_s \bmod 2 = 0 \\ 1,2,4,5 & \text{if } n_s \bmod 2 = 1 \text{ and (1 or 2 PBCH antenna ports)} \\ 2,4,5 & \text{if } n_s \bmod 2 = 1 \text{ and (4 PBCH antenna ports)} \end{cases}$$

$$m = 0,1,\dots,2 \cdot N_{RB}^{PRS} - 1$$

$$m' = m + N_{RB}^{\text{max,DL}} - N_{RB}^{PRS}$$

The bandwidth for positioning reference signals N_{RB}^{PRS} is configured by higher layers and the cell-specific frequency shift is given by $v_{\text{shift}} = N_{ID}^{\text{cell}} \bmod 6$.

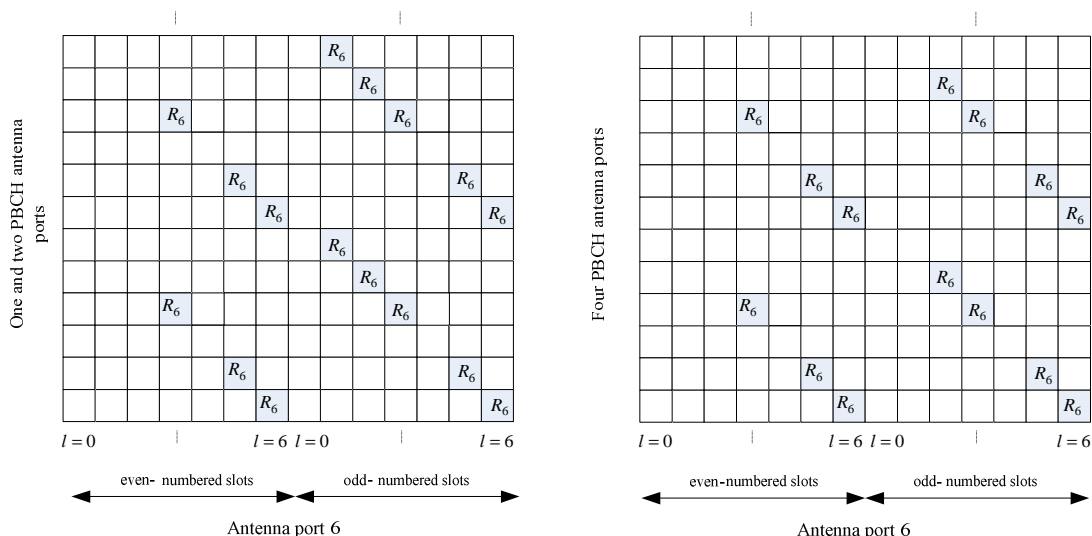

Figure 6.10.4.2-1: Mapping of positioning reference signals (normal cyclic prefix)

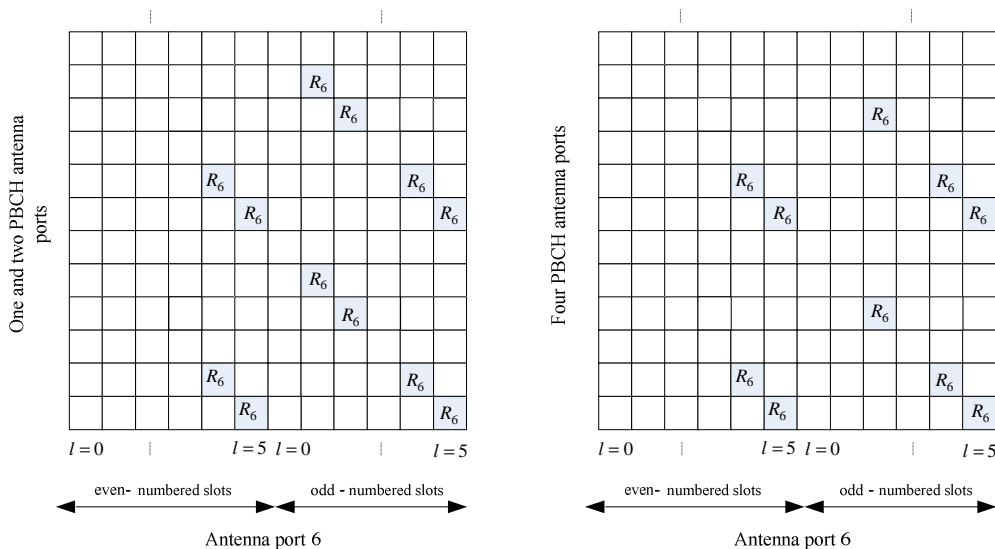

Figure 6.10.4.2-2: Mapping of positioning reference signals (extended cyclic prefix)

6.10.4.3 Positioning reference signal subframe configuration

The cell specific subframe configuration period T_{PRS} and the cell specific subframe offset Δ_{PRS} for the transmission of positioning reference signals are listed in Table 6.10.4.3-1. The PRS configuration index I_{PRS} is configured by higher layers. Positioning reference signals are transmitted only in configured DL subframes. Positioning reference signals shall not be transmitted in special subframes. Positioning reference signals shall be transmitted in N_{PRS} consecutive downlink subframes, where N_{PRS} is configured by higher layers.

The positioning reference signal instances, for the first subframe of the N_{PRS} downlink subframes, shall satisfy $(10 \times n_f + \lfloor n_s / 2 \rfloor - \Delta_{PRS}) \bmod T_{PRS} = 0$.

Table 6.10.4.3-1: Positioning reference signal subframe configuration

PRS configuration Index I_{PRS}	PRS periodicity T_{PRS} (subframes)	PRS subframe offset Δ_{PRS} (subframes)
0 – 159	160	I_{PRS}
160 – 479	320	$I_{PRS} - 160$
480 – 1119	640	$I_{PRS} - 480$
1120 – 2399	1280	$I_{PRS} - 1120$
2400-4095	Reserved	

6.10.5 CSI reference signals

CSI reference signals are transmitted on one, two, four or eight antenna ports using $p = 15$, $p = 15, 16$, $p = 15, \dots, 18$ and $p = 15, \dots, 22$, respectively.

CSI reference signals are defined for $\Delta f = 15$ kHz only.

6.10.5.1 Sequence generation

The reference-signal sequence $r_{l,n_s}(m)$ is defined by

$$r_{l,n_s}(m) = \frac{1}{\sqrt{2}}(1 - 2 \cdot c(2m)) + j \frac{1}{\sqrt{2}}(1 - 2 \cdot c(2m + 1)), \quad m = 0, 1, \dots, N_{RB}^{\max, DL} - 1$$

where n_s is the slot number within a radio frame and l is the OFDM symbol number within the slot. The pseudo-random sequence $c(i)$ is defined in Section 7.2. The pseudo-random sequence generator shall be initialised with $c_{\text{init}} = 2^{10} \cdot (7 \cdot (n_s + 1) + l + 1) \cdot (2 \cdot N_{\text{ID}}^{\text{CSI}} + 1) + 2 \cdot N_{\text{ID}}^{\text{CSI}} + N_{\text{CP}}$ at the start of each OFDM symbol where

$$N_{\text{CP}} = \begin{cases} 1 & \text{for normal CP} \\ 0 & \text{for extended CP} \end{cases}$$

The quantity $N_{\text{ID}}^{\text{CSI}}$ equals $N_{\text{ID}}^{\text{cell}}$ unless configured by higher layers.

6.10.5.2 Mapping to resource elements

In subframes configured for CSI reference signal transmission, the reference signal sequence $r_{l,n_s}(m)$ shall be mapped to complex-valued modulation symbols $a_{k,l}^{(p)}$ used as reference symbols on antenna port p according to

$$a_{k,l}^{(p)} = w_{l''} \cdot r_{l,n_s}(m')$$

where

$$k = k' + 12m + \begin{cases} -0 & \text{for } p \in \{15,16\}, \text{ normal cyclic prefix} \\ -6 & \text{for } p \in \{17,18\}, \text{ normal cyclic prefix} \\ -1 & \text{for } p \in \{19,20\}, \text{ normal cyclic prefix} \\ -7 & \text{for } p \in \{21,22\}, \text{ normal cyclic prefix} \\ -0 & \text{for } p \in \{15,16\}, \text{ extended cyclic prefix} \\ -3 & \text{for } p \in \{17,18\}, \text{ extended cyclic prefix} \\ -6 & \text{for } p \in \{19,20\}, \text{ extended cyclic prefix} \\ -9 & \text{for } p \in \{21,22\}, \text{ extended cyclic prefix} \end{cases}$$

$$l = l' + \begin{cases} l'' & \text{CSI reference signal configurations 0 - 19, normal cyclic prefix} \\ 2l'' & \text{CSI reference signal configurations 20 - 31, normal cyclic prefix} \\ l'' & \text{CSI reference signal configurations 0 - 27, extended cyclic prefix} \end{cases}$$

$$w_{l''} = \begin{cases} 1 & p \in \{15,17,19,21\} \\ (-1)^{l''} & p \in \{16,18,20,22\} \end{cases}$$

$$l'' = 0,1$$

$$m = 0,1,\dots,N_{\text{RB}}^{\text{DL}} - 1$$

$$m' = m + \left\lfloor \frac{N_{\text{RB}}^{\text{max,DL}} - N_{\text{RB}}^{\text{DL}}}{2} \right\rfloor$$

The quantity (k', l') and the necessary conditions on n_s are given by Tables 6.10.5.2-1 and 6.10.5.2-2 for normal and extended cyclic prefix, respectively.

Multiple CSI reference signal configurations can be used in a given cell. A UE can be configured with multiple sets of CSI reference signals,

- up to three configurations for which the UE shall assume non-zero transmission power for the CSI-RS, and
- zero or more configurations for which the UE shall assume zero transmission power.

The CSI-RS configurations for which the UE shall assume non-zero transmission power are provided by higher layers.

The CSI-RS configurations for which the UE shall assume zero transmission power in a subframe are given by a bitmap derived according to Section 7.2.7 in [4]. For each bit set to one in the 16-bit bitmap, the UE shall assume zero transmission power for the resource elements corresponding to the four CSI reference signal column in Tables 6.10.5.2-

1 and 6.10.5.2-2 for normal and extended cyclic prefix, respectively, except for resource elements that overlap with those for which the UE shall assume non-zero transmission power CSI-RS as configured by higher layers. The most significant bit corresponds to the lowest CSI reference signal configuration index and subsequent bits in the bitmap correspond to configurations with indices in increasing order.

CSI reference signals can only occur in

- downlink slots where $n_s \bmod 2$ fulfils the condition in Tables 6.10.5.2-1 and 6.10.5.2-2 for normal and extended cyclic prefix, respectively, and
- where the subframe number fulfils the conditions in Section 6.10.5.3.

The UE shall assume that CSI reference signals are not transmitted

- in the special subframe(s) in case of frame structure type 2,
- in subframes where transmission of a CSI-RS would collide with *SystemInformationBlockType1* messages,
- in the primary cell in subframes configured for transmission of paging messages in the primary cell for any UE with the cell-specific paging configuration.

The UE shall assume that none of the CSI reference signals corresponding to a CSI reference signal configuration are transmitted in subframes where transmission of any of those CSI reference signals would collide with transmission of synchronization signals or PBCH.

Resource elements (k, l) used for transmission of CSI reference signals on any of the antenna ports in the set S , where $S = \{15\}$, $S = \{15,16\}$, $S = \{17,18\}$, $S = \{19,20\}$ or $S = \{21,22\}$ shall not be used for transmission of PDSCH on any antenna port in the same slot.

The mapping for CSI reference signal configuration 0 is illustrated in Figures 6.10.5.2-1 and 6.10.5.2-2.

Table 6.10.5.2-1: Mapping from CSI reference signal configuration to (k', l') for normal cyclic prefix.

	CSI reference signal configuration	Number of CSI reference signals configured					
		1 or 2		4		8	
		(k', l')	$n_s \bmod 2$	(k', l')	$n_s \bmod 2$	(k', l')	$n_s \bmod 2$
Frame structure type 1 and 2	0	(9,5)	0	(9,5)	0	(9,5)	0
	1	(11,2)	1	(11,2)	1	(11,2)	1
	2	(9,2)	1	(9,2)	1	(9,2)	1
	3	(7,2)	1	(7,2)	1	(7,2)	1
	4	(9,5)	1	(9,5)	1	(9,5)	1
	5	(8,5)	0	(8,5)	0		
	6	(10,2)	1	(10,2)	1		
	7	(8,2)	1	(8,2)	1		
	8	(6,2)	1	(6,2)	1		
	9	(8,5)	1	(8,5)	1		
	10	(3,5)	0				
	11	(2,5)	0				
	12	(5,2)	1				
	13	(4,2)	1				
	14	(3,2)	1				
	15	(2,2)	1				
	16	(1,2)	1				
	17	(0,2)	1				
	18	(3,5)	1				
19	(2,5)	1					
Frame structure type 2 only	20	(11,1)	1	(11,1)	1	(11,1)	1
	21	(9,1)	1	(9,1)	1	(9,1)	1
	22	(7,1)	1	(7,1)	1	(7,1)	1
	23	(10,1)	1	(10,1)	1		
	24	(8,1)	1	(8,1)	1		
	25	(6,1)	1	(6,1)	1		
	26	(5,1)	1				
	27	(4,1)	1				

	28	(3,1)	1				
	29	(2,1)	1				
	30	(1,1)	1				
	31	(0,1)	1				

Table 6.10.5.2-2: Mapping from CSI reference signal configuration to (k', l') for extended cyclic prefix.

	CSI reference signal configuration	Number of CSI reference signals configured					
		1 or 2		4		8	
		(k', l')	$n_s \text{ mod } 2$	(k', l')	$n_s \text{ mod } 2$	(k', l')	$n_s \text{ mod } 2$
Frame structure type 1 and 2	0	(11,4)	0	(11,4)	0	(11,4)	0
	1	(9,4)	0	(9,4)	0	(9,4)	0
	2	(10,4)	1	(10,4)	1	(10,4)	1
	3	(9,4)	1	(9,4)	1	(9,4)	1
	4	(5,4)	0	(5,4)	0		
	5	(3,4)	0	(3,4)	0		
	6	(4,4)	1	(4,4)	1		
	7	(3,4)	1	(3,4)	1		
	8	(8,4)	0				
	9	(6,4)	0				
	10	(2,4)	0				
	11	(0,4)	0				
	12	(7,4)	1				
	13	(6,4)	1				
	14	(1,4)	1				
15	(0,4)	1					
Frame structure type 2 only	16	(11,1)	1	(11,1)	1	(11,1)	1
	17	(10,1)	1	(10,1)	1	(10,1)	1
	18	(9,1)	1	(9,1)	1	(9,1)	1
	19	(5,1)	1	(5,1)	1		
	20	(4,1)	1	(4,1)	1		
	21	(3,1)	1	(3,1)	1		
	22	(8,1)	1				
	23	(7,1)	1				
	24	(6,1)	1				
	25	(2,1)	1				
	26	(1,1)	1				
	27	(0,1)	1				

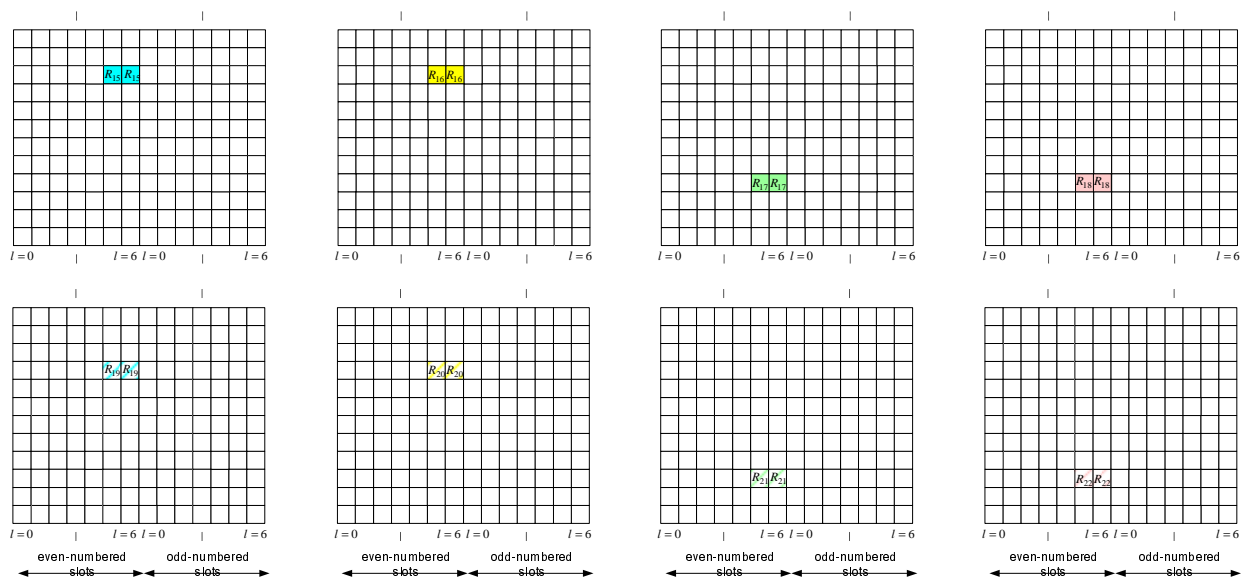

Figure 6.10.5.2-1: Mapping of CSI reference signals (CSI configuration 0, normal cyclic prefix).

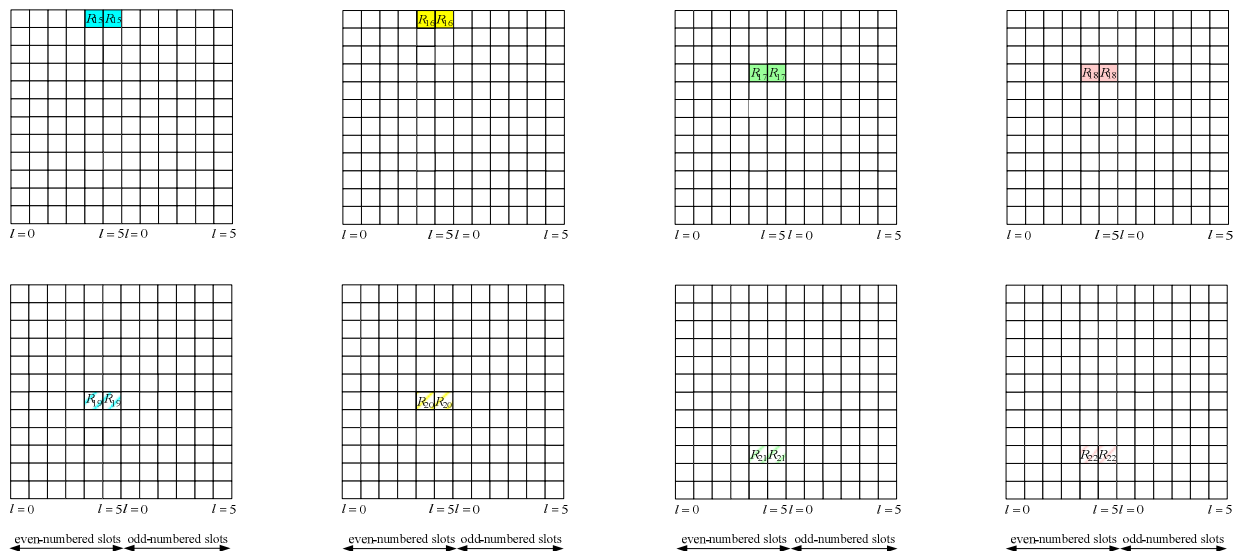

Figure 6.10.5.2-2: Mapping of CSI reference signals (CSI configuration 0, extended cyclic prefix).

6.10.5.3 CSI reference signal subframe configuration

The subframe configuration period $T_{\text{CSI-RS}}$ and the subframe offset $\Delta_{\text{CSI-RS}}$ for the occurrence of CSI reference signals are listed in Table 6.10.5.3-1. The parameter $I_{\text{CSI-RS}}$ can be configured separately for CSI reference signals for which the UE shall assume non-zero and zero transmission power. Subframes containing CSI reference signals shall satisfy $(10n_f + \lfloor n_s/2 \rfloor - \Delta_{\text{CSI-RS}}) \bmod T_{\text{CSI-RS}} = 0$.

Table 6.10.5.3-1: CSI reference signal subframe configuration.

CSI-RS-SubframeConfig $I_{\text{CSI-RS}}$	CSI-RS periodicity $T_{\text{CSI-RS}}$ (subframes)	CSI-RS subframe offset $\Delta_{\text{CSI-RS}}$ (subframes)
0 – 4	5	$I_{\text{CSI-RS}}$
5 – 14	10	$I_{\text{CSI-RS}} - 5$
15 – 34	20	$I_{\text{CSI-RS}} - 15$
35 – 74	40	$I_{\text{CSI-RS}} - 35$
75 – 154	80	$I_{\text{CSI-RS}} - 75$

6.11 Synchronization signals

There are 504 unique physical-layer cell identities. The physical-layer cell identities are grouped into 168 unique physical-layer cell-identity groups, each group containing three unique identities. The grouping is such that each physical-layer cell identity is part of one and only one physical-layer cell-identity group. A physical-layer cell identity $N_{\text{ID}}^{\text{cell}} = 3N_{\text{ID}}^{(1)} + N_{\text{ID}}^{(2)}$ is thus uniquely defined by a number $N_{\text{ID}}^{(1)}$ in the range of 0 to 167, representing the physical-layer cell-identity group, and a number $N_{\text{ID}}^{(2)}$ in the range of 0 to 2, representing the physical-layer identity within the physical-layer cell-identity group.

6.11.1 Primary synchronization signal

6.11.1.1 Sequence generation

The sequence $d(n)$ used for the primary synchronization signal is generated from a frequency-domain Zadoff-Chu sequence according to

$$d_u(n) = \begin{cases} e^{-j\frac{\pi un(n+1)}{63}} & n = 0,1,\dots,30 \\ e^{-j\frac{\pi u(n+1)(n+2)}{63}} & n = 31,32,\dots,61 \end{cases}$$

where the Zadoff-Chu root sequence index u is given by Table 6.11.1.1-1.

Table 6.11.1.1-1: Root indices for the primary synchronization signal.

$N_{ID}^{(2)}$	Root index u
0	25
1	29
2	34

6.11.1.2 Mapping to resource elements

The mapping of the sequence to resource elements depends on the frame structure. The UE shall not assume that the primary synchronization signal is transmitted on the same antenna port as any of the downlink reference signals. The UE shall not assume that any transmission instance of the primary synchronization signal is transmitted on the same antenna port, or ports, used for any other transmission instance of the primary synchronization signal.

The sequence $d(n)$ shall be mapped to the resource elements according to

$$a_{k,l} = d(n), \quad n = 0, \dots, 61$$

$$k = n - 31 + \frac{N_{RB}^{DL} N_{sc}^{RB}}{2}$$

For frame structure type 1, the primary synchronization signal shall be mapped to the last OFDM symbol in slots 0 and 10.

For frame structure type 2, the primary synchronization signal shall be mapped to the third OFDM symbol in subframes 1 and 6. Resource elements (k, l) in the OFDM symbols used for transmission of the primary synchronization signal where

$$k = n - 31 + \frac{N_{RB}^{DL} N_{sc}^{RB}}{2}$$

$$n = -5, -4, \dots, -1, 62, 63, \dots, 66$$

are reserved and not used for transmission of the primary synchronization signal.

6.11.2 Secondary synchronization signal

6.11.2.1 Sequence generation

The sequence $d(0), \dots, d(61)$ used for the second synchronization signal is an interleaved concatenation of two length-31 binary sequences. The concatenated sequence is scrambled with a scrambling sequence given by the primary synchronization signal.

The combination of two length-31 sequences defining the secondary synchronization signal differs between subframe 0 and subframe 5 according to

$$d(2n) = \begin{cases} s_0^{(m_0)}(n)c_0(n) & \text{in subframe 0} \\ s_1^{(m_1)}(n)c_0(n) & \text{in subframe 5} \end{cases}$$

$$d(2n+1) = \begin{cases} s_1^{(m_1)}(n)c_1(n)z_1^{(m_0)}(n) & \text{in subframe 0} \\ s_0^{(m_0)}(n)c_1(n)z_1^{(m_1)}(n) & \text{in subframe 5} \end{cases}$$

where $0 \leq n \leq 30$. The indices m_0 and m_1 are derived from the physical-layer cell-identity group $N_{\text{ID}}^{(1)}$ according to

$$\begin{aligned} m_0 &= m' \bmod 31 \\ m_1 &= (m_0 + \lfloor m'/31 \rfloor + 1) \bmod 31 \\ m' &= N_{\text{ID}}^{(1)} + q(q+1)/2, \quad q = \left\lfloor \frac{N_{\text{ID}}^{(1)} + q'(q'+1)/2}{30} \right\rfloor, \quad q' = \lfloor N_{\text{ID}}^{(1)}/30 \rfloor \end{aligned}$$

where the output of the above expression is listed in Table 6.11.2.1-1.

The two sequences $s_0^{(m_0)}(n)$ and $s_1^{(m_1)}(n)$ are defined as two different cyclic shifts of the m-sequence $\tilde{s}(n)$ according to

$$\begin{aligned} s_0^{(m_0)}(n) &= \tilde{s}((n + m_0) \bmod 31) \\ s_1^{(m_1)}(n) &= \tilde{s}((n + m_1) \bmod 31) \end{aligned}$$

where $\tilde{s}(i) = 1 - 2x(i)$, $0 \leq i \leq 30$, is defined by

$$x(\bar{i} + 5) = (x(\bar{i} + 2) + x(\bar{i})) \bmod 2, \quad 0 \leq \bar{i} \leq 25$$

with initial conditions $x(0) = 0$, $x(1) = 0$, $x(2) = 0$, $x(3) = 0$, $x(4) = 1$.

The two scrambling sequences $c_0(n)$ and $c_1(n)$ depend on the primary synchronization signal and are defined by two different cyclic shifts of the m-sequence $\tilde{c}(n)$ according to

$$\begin{aligned} c_0(n) &= \tilde{c}((n + N_{\text{ID}}^{(2)}) \bmod 31) \\ c_1(n) &= \tilde{c}((n + N_{\text{ID}}^{(2)} + 3) \bmod 31) \end{aligned}$$

where $N_{\text{ID}}^{(2)} \in \{0,1,2\}$ is the physical-layer identity within the physical-layer cell identity group $N_{\text{ID}}^{(1)}$ and $\tilde{c}(i) = 1 - 2x(i)$, $0 \leq i \leq 30$, is defined by

$$x(\bar{i} + 5) = (x(\bar{i} + 3) + x(\bar{i})) \bmod 2, \quad 0 \leq \bar{i} \leq 25$$

with initial conditions $x(0) = 0$, $x(1) = 0$, $x(2) = 0$, $x(3) = 0$, $x(4) = 1$.

The scrambling sequences $z_1^{(m_0)}(n)$ and $z_1^{(m_1)}(n)$ are defined by a cyclic shift of the m-sequence $\tilde{z}(n)$ according to

$$\begin{aligned} z_1^{(m_0)}(n) &= \tilde{z}((n + (m_0 \bmod 8)) \bmod 31) \\ z_1^{(m_1)}(n) &= \tilde{z}((n + (m_1 \bmod 8)) \bmod 31) \end{aligned}$$

where m_0 and m_1 are obtained from Table 6.11.2.1-1 and $\tilde{z}(i) = 1 - 2x(i)$, $0 \leq i \leq 30$, is defined by

$$x(\bar{i} + 5) = (x(\bar{i} + 4) + x(\bar{i} + 2) + x(\bar{i} + 1) + x(\bar{i})) \bmod 2, \quad 0 \leq \bar{i} \leq 25$$

with initial conditions $x(0) = 0$, $x(1) = 0$, $x(2) = 0$, $x(3) = 0$, $x(4) = 1$.

Table 6.11.2.1-1: Mapping between physical-layer cell-identity group $N_{ID}^{(1)}$ and the indices m_0 and m_1 .

$N_{ID}^{(1)}$	m_0	m_1	$N_{ID}^{(1)}$	m_0	m_1	$N_{ID}^{(1)}$	m_0	m_1	$N_{ID}^{(1)}$	m_0	m_1	$N_{ID}^{(1)}$	m_0	m_1
0	0	1	34	4	6	68	9	12	102	15	19	136	22	27
1	1	2	35	5	7	69	10	13	103	16	20	137	23	28
2	2	3	36	6	8	70	11	14	104	17	21	138	24	29
3	3	4	37	7	9	71	12	15	105	18	22	139	25	30
4	4	5	38	8	10	72	13	16	106	19	23	140	0	6
5	5	6	39	9	11	73	14	17	107	20	24	141	1	7
6	6	7	40	10	12	74	15	18	108	21	25	142	2	8
7	7	8	41	11	13	75	16	19	109	22	26	143	3	9
8	8	9	42	12	14	76	17	20	110	23	27	144	4	10
9	9	10	43	13	15	77	18	21	111	24	28	145	5	11
10	10	11	44	14	16	78	19	22	112	25	29	146	6	12
11	11	12	45	15	17	79	20	23	113	26	30	147	7	13
12	12	13	46	16	18	80	21	24	114	0	5	148	8	14
13	13	14	47	17	19	81	22	25	115	1	6	149	9	15
14	14	15	48	18	20	82	23	26	116	2	7	150	10	16
15	15	16	49	19	21	83	24	27	117	3	8	151	11	17
16	16	17	50	20	22	84	25	28	118	4	9	152	12	18
17	17	18	51	21	23	85	26	29	119	5	10	153	13	19
18	18	19	52	22	24	86	27	30	120	6	11	154	14	20
19	19	20	53	23	25	87	0	4	121	7	12	155	15	21
20	20	21	54	24	26	88	1	5	122	8	13	156	16	22
21	21	22	55	25	27	89	2	6	123	9	14	157	17	23
22	22	23	56	26	28	90	3	7	124	10	15	158	18	24
23	23	24	57	27	29	91	4	8	125	11	16	159	19	25
24	24	25	58	28	30	92	5	9	126	12	17	160	20	26
25	25	26	59	0	3	93	6	10	127	13	18	161	21	27
26	26	27	60	1	4	94	7	11	128	14	19	162	22	28
27	27	28	61	2	5	95	8	12	129	15	20	163	23	29
28	28	29	62	3	6	96	9	13	130	16	21	164	24	30
29	29	30	63	4	7	97	10	14	131	17	22	165	0	7
30	0	2	64	5	8	98	11	15	132	18	23	166	1	8
31	1	3	65	6	9	99	12	16	133	19	24	167	2	9
32	2	4	66	7	10	100	13	17	134	20	25	-	-	-
33	3	5	67	8	11	101	14	18	135	21	26	-	-	-

6.11.2.2 Mapping to resource elements

The mapping of the sequence to resource elements depends on the frame structure. In a subframe for frame structure type 1 and in a half-frame for frame structure type 2, the same antenna port as for the primary synchronization signal shall be used for the secondary synchronization signal.

The sequence $d(n)$ shall be mapped to resource elements according to

$$a_{k,l} = d(n), \quad n = 0, \dots, 61$$

$$k = n - 31 + \frac{N_{RB}^{DL} N_{sc}^{RB}}{2}$$

$$l = \begin{cases} N_{\text{symp}}^{DL} - 2 & \text{in slots 0 and 10} & \text{for frame structure type 1} \\ N_{\text{symp}}^{DL} - 1 & \text{in slots 1 and 11} & \text{for frame structure type 2} \end{cases}$$

Resource elements (k, l) where

$$k = n - 31 + \frac{N_{RB}^{DL} N_{sc}^{RB}}{2}$$

$$l = \begin{cases} N_{\text{symb}}^{DL} - 2 & \text{in slots 0 and 10 for frame structure type 1} \\ N_{\text{symb}}^{DL} - 1 & \text{in slots 1 and 11 for frame structure type 2} \end{cases}$$

$$n = -5, -4, \dots, -1, 62, 63, \dots, 66$$

are reserved and not used for transmission of the secondary synchronization signal.

6.12 OFDM baseband signal generation

The time-continuous signal $s_l^{(p)}(t)$ on antenna port p in OFDM symbol l in a downlink slot is defined by

$$s_l^{(p)}(t) = \sum_{k=-\lfloor N_{RB}^{DL} N_{sc}^{RB} / 2 \rfloor}^{-1} a_{k^{(-)},l}^{(p)} \cdot e^{j2\pi k \Delta f (t - N_{CP,l} T_s)} + \sum_{k=1}^{\lfloor N_{RB}^{DL} N_{sc}^{RB} / 2 \rfloor} a_{k^{(+)},l}^{(p)} \cdot e^{j2\pi k \Delta f (t - N_{CP,l} T_s)}$$

for $0 \leq t < (N_{CP,l} + N) \times T_s$ where $k^{(-)} = k + \lfloor N_{RB}^{DL} N_{sc}^{RB} / 2 \rfloor$ and $k^{(+)} = k + \lfloor N_{RB}^{DL} N_{sc}^{RB} / 2 \rfloor - 1$. The variable N equals 2048 for $\Delta f = 15$ kHz subcarrier spacing and 4096 for $\Delta f = 7.5$ kHz subcarrier spacing.

The OFDM symbols in a slot shall be transmitted in increasing order of l , starting with $l = 0$, where OFDM symbol $l > 0$ starts at time $\sum_{l'=0}^{l-1} (N_{CP,l'} + N) T_s$ within the slot. In case the first OFDM symbol(s) in a slot use normal cyclic prefix and the remaining OFDM symbols use extended cyclic prefix, the starting position the OFDM symbols with extended cyclic prefix shall be identical to those in a slot where all OFDM symbols use extended cyclic prefix. Thus there will be a part of the time slot between the two cyclic prefix regions where the transmitted signal is not specified.

Table 6.12-1 lists the value of $N_{CP,l}$ that shall be used. Note that different OFDM symbols within a slot in some cases have different cyclic prefix lengths.

Table 6.12-1: OFDM parameters.

Configuration		Cyclic prefix length $N_{CP,l}$
Normal cyclic prefix	$\Delta f = 15$ kHz	160 for $l = 0$ 144 for $l = 1, 2, \dots, 6$
	$\Delta f = 7.5$ kHz	1024 for $l = 0, 1, 2$
Extended cyclic prefix	$\Delta f = 15$ kHz	512 for $l = 0, 1, \dots, 5$
	$\Delta f = 7.5$ kHz	1024 for $l = 0, 1, 2$

6.13 Modulation and upconversion

Modulation and upconversion to the carrier frequency of the complex-valued OFDM baseband signal for each antenna port is shown in Figure 6.13-1. The filtering required prior to transmission is defined by the requirements in [6].

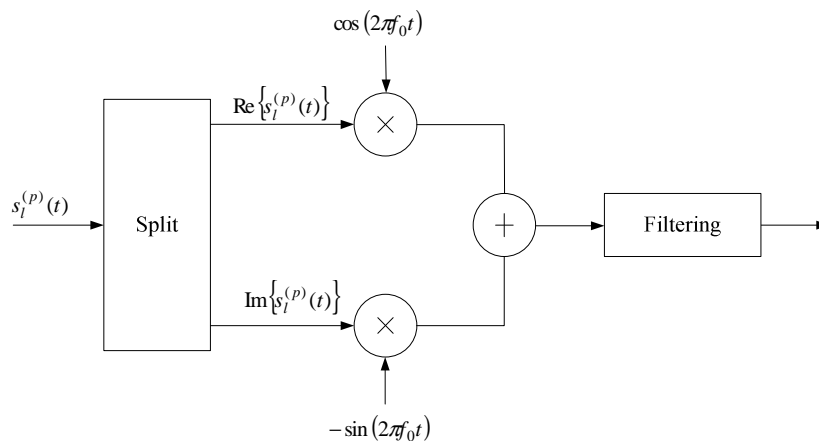

Figure 6.13-1: Downlink modulation.

7 Generic functions

7.1 Modulation mapper

The modulation mapper takes binary digits, 0 or 1, as input and produces complex-valued modulation symbols, $x=I+jQ$, as output.

7.1.1 BPSK

In case of BPSK modulation, a single bit, $b(i)$, is mapped to a complex-valued modulation symbol $x=I+jQ$ according to Table 7.1.1-1.

Table 7.1.1-1: BPSK modulation mapping.

$b(i)$	I	Q
0	$1/\sqrt{2}$	$1/\sqrt{2}$
1	$-1/\sqrt{2}$	$-1/\sqrt{2}$

7.1.2 QPSK

In case of QPSK modulation, pairs of bits, $b(i), b(i+1)$, are mapped to complex-valued modulation symbols $x=I+jQ$ according to Table 7.1.2-1.

Table 7.1.2-1: QPSK modulation mapping.

$b(i), b(i+1)$	I	Q
00	$1/\sqrt{2}$	$1/\sqrt{2}$
01	$1/\sqrt{2}$	$-1/\sqrt{2}$
10	$-1/\sqrt{2}$	$1/\sqrt{2}$
11	$-1/\sqrt{2}$	$-1/\sqrt{2}$

7.1.3 16QAM

In case of 16QAM modulation, quadruplets of bits, $b(i), b(i+1), b(i+2), b(i+3)$, are mapped to complex-valued modulation symbols $x=I+jQ$ according to Table 7.1.3-1.

Table 7.1.3-1: 16QAM modulation mapping.

$b(i), b(i+1), b(i+2), b(i+3)$	I	Q
0000	$1/\sqrt{10}$	$1/\sqrt{10}$
0001	$1/\sqrt{10}$	$3/\sqrt{10}$
0010	$3/\sqrt{10}$	$1/\sqrt{10}$
0011	$3/\sqrt{10}$	$3/\sqrt{10}$
0100	$1/\sqrt{10}$	$-1/\sqrt{10}$
0101	$1/\sqrt{10}$	$-3/\sqrt{10}$
0110	$3/\sqrt{10}$	$-1/\sqrt{10}$
0111	$3/\sqrt{10}$	$-3/\sqrt{10}$
1000	$-1/\sqrt{10}$	$1/\sqrt{10}$
1001	$-1/\sqrt{10}$	$3/\sqrt{10}$
1010	$-3/\sqrt{10}$	$1/\sqrt{10}$
1011	$-3/\sqrt{10}$	$3/\sqrt{10}$
1100	$-1/\sqrt{10}$	$-1/\sqrt{10}$
1101	$-1/\sqrt{10}$	$-3/\sqrt{10}$
1110	$-3/\sqrt{10}$	$-1/\sqrt{10}$
1111	$-3/\sqrt{10}$	$-3/\sqrt{10}$

7.1.4 64QAM

In case of 64QAM modulation, hexuplets of bits, $b(i), b(i+1), b(i+2), b(i+3), b(i+4), b(i+5)$, are mapped to complex-valued modulation symbols $x=I+jQ$ according to Table 7.1.4-1.

Table 7.1.4-1: 64QAM modulation mapping.

$b(i), b(i+1), b(i+2), b(i+3), b(i+4), b(i+5)$	I	Q	$b(i), b(i+1), b(i+2), b(i+3), b(i+4), b(i+5)$	I	Q
000000	$3/\sqrt{42}$	$3/\sqrt{42}$	100000	$-3/\sqrt{42}$	$3/\sqrt{42}$
000001	$3/\sqrt{42}$	$1/\sqrt{42}$	100001	$-3/\sqrt{42}$	$1/\sqrt{42}$
000010	$1/\sqrt{42}$	$3/\sqrt{42}$	100010	$-1/\sqrt{42}$	$3/\sqrt{42}$
000011	$1/\sqrt{42}$	$1/\sqrt{42}$	100011	$-1/\sqrt{42}$	$1/\sqrt{42}$
000100	$3/\sqrt{42}$	$5/\sqrt{42}$	100100	$-3/\sqrt{42}$	$5/\sqrt{42}$
000101	$3/\sqrt{42}$	$7/\sqrt{42}$	100101	$-3/\sqrt{42}$	$7/\sqrt{42}$
000110	$1/\sqrt{42}$	$5/\sqrt{42}$	100110	$-1/\sqrt{42}$	$5/\sqrt{42}$
000111	$1/\sqrt{42}$	$7/\sqrt{42}$	100111	$-1/\sqrt{42}$	$7/\sqrt{42}$
001000	$5/\sqrt{42}$	$3/\sqrt{42}$	101000	$-5/\sqrt{42}$	$3/\sqrt{42}$
001001	$5/\sqrt{42}$	$1/\sqrt{42}$	101001	$-5/\sqrt{42}$	$1/\sqrt{42}$
001010	$7/\sqrt{42}$	$3/\sqrt{42}$	101010	$-7/\sqrt{42}$	$3/\sqrt{42}$
001011	$7/\sqrt{42}$	$1/\sqrt{42}$	101011	$-7/\sqrt{42}$	$1/\sqrt{42}$
001100	$5/\sqrt{42}$	$5/\sqrt{42}$	101100	$-5/\sqrt{42}$	$5/\sqrt{42}$
001101	$5/\sqrt{42}$	$7/\sqrt{42}$	101101	$-5/\sqrt{42}$	$7/\sqrt{42}$
001110	$7/\sqrt{42}$	$5/\sqrt{42}$	101110	$-7/\sqrt{42}$	$5/\sqrt{42}$
001111	$7/\sqrt{42}$	$7/\sqrt{42}$	101111	$-7/\sqrt{42}$	$7/\sqrt{42}$
010000	$3/\sqrt{42}$	$-3/\sqrt{42}$	110000	$-3/\sqrt{42}$	$-3/\sqrt{42}$
010001	$3/\sqrt{42}$	$-1/\sqrt{42}$	110001	$-3/\sqrt{42}$	$-1/\sqrt{42}$
010010	$1/\sqrt{42}$	$-3/\sqrt{42}$	110010	$-1/\sqrt{42}$	$-3/\sqrt{42}$
010011	$1/\sqrt{42}$	$-1/\sqrt{42}$	110011	$-1/\sqrt{42}$	$-1/\sqrt{42}$
010100	$3/\sqrt{42}$	$-5/\sqrt{42}$	110100	$-3/\sqrt{42}$	$-5/\sqrt{42}$
010101	$3/\sqrt{42}$	$-7/\sqrt{42}$	110101	$-3/\sqrt{42}$	$-7/\sqrt{42}$
010110	$1/\sqrt{42}$	$-5/\sqrt{42}$	110110	$-1/\sqrt{42}$	$-5/\sqrt{42}$
010111	$1/\sqrt{42}$	$-7/\sqrt{42}$	110111	$-1/\sqrt{42}$	$-7/\sqrt{42}$
011000	$5/\sqrt{42}$	$-3/\sqrt{42}$	111000	$-5/\sqrt{42}$	$-3/\sqrt{42}$
011001	$5/\sqrt{42}$	$-1/\sqrt{42}$	111001	$-5/\sqrt{42}$	$-1/\sqrt{42}$
011010	$7/\sqrt{42}$	$-3/\sqrt{42}$	111010	$-7/\sqrt{42}$	$-3/\sqrt{42}$
011011	$7/\sqrt{42}$	$-1/\sqrt{42}$	111011	$-7/\sqrt{42}$	$-1/\sqrt{42}$
011100	$5/\sqrt{42}$	$-5/\sqrt{42}$	111100	$-5/\sqrt{42}$	$-5/\sqrt{42}$
011101	$5/\sqrt{42}$	$-7/\sqrt{42}$	111101	$-5/\sqrt{42}$	$-7/\sqrt{42}$
011110	$7/\sqrt{42}$	$-5/\sqrt{42}$	111110	$-7/\sqrt{42}$	$-5/\sqrt{42}$
011111	$7/\sqrt{42}$	$-7/\sqrt{42}$	111111	$-7/\sqrt{42}$	$-7/\sqrt{42}$

7.2 Pseudo-random sequence generation

Pseudo-random sequences are defined by a length-31 Gold sequence. The output sequence $c(n)$ of length M_{PN} , where $n = 0, 1, \dots, M_{\text{PN}} - 1$, is defined by

$$\begin{aligned}
 c(n) &= (x_1(n + N_c) + x_2(n + N_c)) \bmod 2 \\
 x_1(n + 31) &= (x_1(n + 3) + x_1(n)) \bmod 2 \\
 x_2(n + 31) &= (x_2(n + 3) + x_2(n + 2) + x_2(n + 1) + x_2(n)) \bmod 2
 \end{aligned}$$

where $N_c = 1600$ and the first m-sequence shall be initialized with $x_1(0) = 1, x_1(n) = 0, n = 1, 2, \dots, 30$. The initialization of the second m-sequence is denoted by $c_{\text{init}} = \sum_{i=0}^{30} x_2(i) \cdot 2^i$ with the value depending on the application of the sequence.

8 Timing

8.1 Uplink-downlink frame timing

Transmission of the uplink radio frame number i from the UE shall start $(N_{\text{TA}} + N_{\text{TA offset}}) \times T_s$ seconds before the start of the corresponding downlink radio frame at the UE, where $0 \leq N_{\text{TA}} \leq 20512$, $N_{\text{TA offset}} = 0$ for frame structure type 1 and $N_{\text{TA offset}} = 624$ for frame structure type 2. Note that not all slots in a radio frame may be transmitted. One example hereof is TDD, where only a subset of the slots in a radio frame is transmitted.

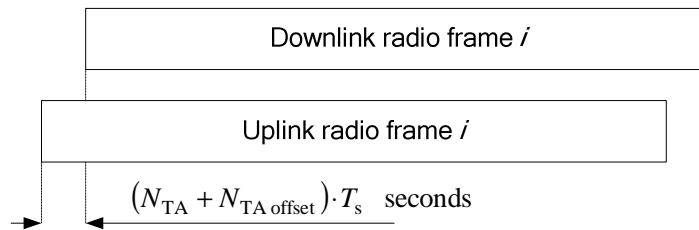

Figure 8.1-1: Uplink-downlink timing relation.

Annex A (informative): Change history

Change history							
Date	TSG #	TSG Doc.	CR	Rev	Subject/Comment	Old	New
2006-09-24	-	-	-	-	Draft version created	-	0.0.0
2006-10-09	-	-	-	-	Updated skeleton	0.0.0	0.0.1
2006-10-13	-	-	-	-	Endorsed by RAN1	0.0.1	0.1.0
2006-10-23	-	-	-	-	Inclusion of decision from RAN1#46bis	0.1.0	0.1.1
2006-11-06	-	-	-	-	Updated editor's version	0.1.1	0.1.2
2006-11-09	-	-	-	-	Updated editor's version	0.1.2	0.1.3
2006-11-10	-	-	-	-	Endorsed by RAN1#47	0.1.3	0.2.0
2006-11-27	-	-	-	-	Editor's version, including decisions from RAN1#47	0.2.0	0.2.1
2006-12-14	-	-	-	-	Updated editor's version	0.2.1	0.2.2
2007-01-15	-	-	-	-	Updated editor's version	0.2.2	0.2.3
2007-01-19	-	-	-	-	Endorsed by RAN1#47bis	0.2.3	0.3.0
2007-02-01	-	-	-	-	Editor's version, including decisions from RAN1#47bis	0.3.0	0.3.1
2007-02-12	-	-	-	-	Updated editor's version	0.3.1	0.3.2
2007-02-16	-	-	-	-	Endorsed by RAN1#48	0.3.2	0.4.0
2007-02-16	-	-	-	-	Editor's version, including decisions from RAN1#48	0.4.0	0.4.1
2007-02-21	-	-	-	-	Updated editor's version	0.4.1	0.4.2
2007-03-03	RAN#35	RP-070169	-	-	For information at RAN#35	0.4.2	1.0.0
2007-04-25	-	-	-	-	Editor's version, including decisions from RAN1#48bis and RAN1 TDD Ad Hoc	1.0.0	1.0.1
2007-05-03	-	-	-	-	Updated editor's version	1.0.1	1.0.2
2007-05-08	-	-	-	-	Updated editor's version	1.0.2	1.0.3
2007-05-11	-	-	-	-	Updated editor's version	1.0.3	1.0.4
2007-05-11	-	-	-	-	Endorsed by RAN1#49	1.0.4	1.1.0
2007-05-15	-	-	-	-	Editor's version, including decisions from RAN1#49	1.1.0	1.1.1
2007-06-05	-	-	-	-	Updated editor's version	1.1.1	1.1.2
2007-06-25	-	-	-	-	Endorsed by RAN1#49bis	1.1.2	1.2.0
2007-07-10	-	-	-	-	Editor's version, including decisions from RAN1#49bis	1.2.0	1.2.1
2007-08-10	-	-	-	-	Updated editor's version	1.2.1	1.2.2
2007-08-20	-	-	-	-	Updated editor's version	1.2.2	1.2.3
2007-08-24	-	-	-	-	Endorsed by RAN1#50	1.2.3	1.3.0
2007-08-27	-	-	-	-	Editor's version, including decisions from RAN1#50	1.3.0	1.3.1
2007-09-05	-	-	-	-	Updated editor's version	1.3.1	1.3.2
2007-09-08	RAN#37	RP-070729	-	-	For approval at RAN#37	1.3.2	2.0.0
12/09/07	RAN_37	RP-070729	-	-	Approved version	2.0.0	8.0.0
28/11/07	RAN_38	RP-070949	0001	-	Introduction of optimized FS2 for TDD	8.0.0	8.1.0
28/11/07	RAN_38	RP-070949	0002	-	Introduction of scrambling sequences, uplink reference signal sequences, secondary synchronization sequences and control channel processing	8.0.0	8.1.0
05/03/08	RAN_39	RP-080219	0003	1	Update of uplink reference-signal hopping, downlink reference signals, scrambling sequences, DwPTS/UpPTS lengths for TDD and control channel processing	8.1.0	8.2.0
28/05/08	RAN_40	RP-080432	0004	-	Correction of the number of subcarriers in PUSCH transform precoding	8.2.0	8.3.0
28/05/08	RAN_40	RP-080432	0005	-	Correction of PHICH mapping	8.2.0	8.3.0
28/05/08	RAN_40	RP-080432	0006	-	Correction of PUCCH resource index for PUCCH format 2	8.2.0	8.3.0
28/05/08	RAN_40	RP-080432	0007	3	Correction of the predefined hopping pattern for PUSCH	8.2.0	8.3.0
28/05/08	RAN_40	RP-080432	0008	-	Non-binary hashing functions	8.2.0	8.3.0
28/05/08	RAN_40	RP-080432	0009	1	PUCCH format 1	8.2.0	8.3.0
28/05/08	RAN_40	RP-080432	0010	1	CR on Uplink DM RS hopping	8.2.0	8.3.0
28/05/08	RAN_40	RP-080432	0012	1	Correction to limitation of constellation size of ACK transmission in PUSCH	8.2.0	8.3.0
28/05/08	RAN_40	RP-080432	0015	1	PHICH mapping for one and two antenna ports in extended CP	8.2.0	8.3.0
28/05/08	RAN_40	RP-080432	0016	1	Correction of PUCCH in absent of mixed format	8.2.0	8.3.0
28/05/08	RAN_40	RP-080432	0017	-	Specification of CCE size and PHICH resource indication	8.2.0	8.3.0
28/05/08	RAN_40	RP-080432	0018	3	Correction of the description of frame structure type 2	8.2.0	8.3.0
28/05/08	RAN_40	RP-080432	0019	-	On Delta ^{pucch} shift correction	8.2.0	8.3.0
28/05/08	RAN_40	RP-080432	0021	-	Corrections to Secondary Synchronization Signal Mapping	8.2.0	8.3.0
28/05/08	RAN_40	RP-080432	0022	-	Downlink VRB mapping to PRB for distributed transmission	8.2.0	8.3.0
28/05/08	RAN_40	RP-080432	0023	-	Clarification of modulation symbols to REs mapping for DVRB	8.2.0	8.3.0
28/05/08	RAN_40	RP-080432	0024	1	Consideration on the scrambling of PDSCH	8.2.0	8.3.0
28/05/08	RAN_40	RP-080432	0025	-	Corrections to Initialization of DL RS Scrambling	8.2.0	8.3.0
28/05/08	RAN_40	RP-080432	0026	1	CR on Downlink RS	8.2.0	8.3.0
28/05/08	RAN_40	RP-080432	0027	-	CR on Uplink RS	8.2.0	8.3.0

Change history							
Date	TSG #	TSG Doc.	CR	Rev	Subject/Comment	Old	New
28/05/08	RAN_40	RP-080432	0028	1	Fixed timing advance offset for LTE TDD and half-duplex FDD	8.2.0	8.3.0
28/05/08	RAN_40	RP-080432	0029	1	Timing of random access preamble format 4	8.2.0	8.3.0
28/05/08	RAN_40	RP-080432	0030	1	Uplink sounding RS bandwidth configuration	8.2.0	8.3.0
28/05/08	RAN_40	RP-080432	0031	-	Use of common RS when UE-specific RS are configured	8.2.0	8.3.0
28/05/08	RAN_40	RP-080432	0032	1	Uplink RS Updates	8.2.0	8.3.0
28/05/08	RAN_40	RP-080432	0033	-	Orthogonal cover sequence for shortened PUCCH format 1a and 1b	8.2.0	8.3.0
28/05/08	RAN_40	RP-080432	0034	-	Clarification of PDCCH mapping	8.2.0	8.3.0
28/05/08	RAN_40	RP-080432	0035	-	TDD PRACH time/frequency mapping	8.2.0	8.3.0
28/05/08	RAN_40	RP-080432	0036	-	Cell Specific Uplink Sounding RS Subframe Configuration	8.2.0	8.3.0
28/05/08	RAN_40	RP-080432	0038	-	PDCCH length for carriers with mixed MBSFN and Unicast Traffic	8.2.0	8.3.0
28/05/08	RAN_40	RP-080432	0040	-	Correction to the scrambling sequence generation for PUCCH, PCFICH, PHICH, MBSFN RS and UE specific RS	8.2.0	8.3.0
28/05/08	RAN_40	RP-080432	0041	-	PDCCH coverage in narrow bandwidths	8.2.0	8.3.0
28/05/08	RAN_40	RP-080432	0042	-	Closed-Loop and Open-Loop Spatial Multiplexing	8.2.0	8.3.0
28/05/08	RAN_40	RP-080432	0043	-	Removal of small-delay CDD	8.2.0	8.3.0
09/09/08	RAN_41	RP-080668	48	1	Frequency Shifting of UE-specific RS	8.3.0	8.4.0
09/09/08	RAN_41	RP-080668	49	1	Correction of PHICH to RE mapping in extended CP subframe	8.3.0	8.4.0
09/09/08	RAN_41	RP-080668	50	-	Corrections to for handling remaining Res	8.3.0	8.4.0
09/09/08	RAN_41	RP-080668	51	-	PRACH configuration for frame structure type 1	8.3.0	8.4.0
09/09/08	RAN_41	RP-080668	52	2	Correction of PUCCH index generation formula	8.3.0	8.4.0
09/09/08	RAN_41	RP-080668	53	-	Orthogonal cover sequence for shortened PUCCH format 1a and 1b	8.3.0	8.4.0
09/09/08	RAN_41	RP-080668	54	-	Correction of mapping of ACK/NAK to binary bit values	8.3.0	8.4.0
09/09/08	RAN_41	RP-080668	56	2	Remaining issues on SRS hopping	8.3.0	8.4.0
09/09/08	RAN_41	RP-080668	57	1	Correction of n _{cs} (n _s) and OC/CS remapping for PUCCH formats 1/1a/1b and 2/2a/2b	8.3.0	8.4.0
09/09/08	RAN_41	RP-080668	59	-	Corrections to Rank information scrambling in Uplink Shared Channel	8.3.0	8.4.0
09/09/08	RAN_41	RP-080668	60	-	Definition on the slot number for frame structure type 2	8.3.0	8.4.0
09/09/08	RAN_41	RP-080668	61	-	Correction of the N _{pucch} sequence upper limit for the formats 1/1a/1b	8.3.0	8.4.0
09/09/08	RAN_41	RP-080668	62	1	Clarifications for DMRS parameters	8.3.0	8.4.0
09/09/08	RAN_41	RP-080668	63	-	Correction of n _{prs}	8.3.0	8.4.0
09/09/08	RAN_41	RP-080668	64	1	Introducing missing L1 parameters to 36.211	8.3.0	8.4.0
09/09/08	RAN_41	RP-080668	65	3	Clarification on reception of synchronization signals	8.3.0	8.4.0
09/09/08	RAN_41	RP-080668	66	-	Correction to the downlink/uplink timing	8.3.0	8.4.0
09/09/08	RAN_41	RP-080668	67	-	ACK/NAK Scrambling scheme on PUCCH	8.3.0	8.4.0
09/09/08	RAN_41	RP-080668	68	-	DCI format1C	8.3.0	8.4.0
09/09/08	RAN_41	RP-080668	69	-	Refinement for REG Definition for n = 4	8.3.0	8.4.0
09/09/08	RAN_41	RP-080668	71	-	Correcting N _{cs} value for PRACH preamble format 0-3	8.3.0	8.4.0
09/09/08	RAN_41	RP-080668	73	-	Correction of the half duplex timing advance offset value	8.3.0	8.4.0
09/09/08	RAN_41	RP-080668	74	-	Correction to Precoding for Transmit Diversity	8.3.0	8.4.0
09/09/08	RAN_41	RP-080668	75	-	Clarification on number of OFDM symbols used for PDCCH	8.3.0	8.4.0
09/09/08	RAN_41	RP-080668	77	-	Number of antenna ports for PDSCH	8.3.0	8.4.0
09/09/08	RAN_41	RP-080668	78	-	Correction to Type 2 PUSCH predetermined hopping for N _{sb} =1 operation	8.3.0	8.4.0
09/09/08	RAN_41	RP-080668	79	-	PRACH frequency location	8.3.0	8.4.0
03/12/08	RAN_42	RP-081074	70	1	Correction for the definition of UE-specific reference signals	8.4.0	8.5.0
03/12/08	RAN_42	RP-081074	72	2	Corrections to precoding for large delay CDD	8.4.0	8.5.0
03/12/08	RAN_42	RP-081074	80	-	Correction to the definition of n _{bar_{oc}} for extended CP	8.4.0	8.5.0
03/12/08	RAN_42	RP-081074	81	1	Specification of reserved REs not used for RS	8.4.0	8.5.0
03/12/08	RAN_42	RP-081074	82	2	Clarification of the random access preamble transmission timing	8.4.0	8.5.0
03/12/08	RAN_42	RP-081074	83	1	Indexing of PRACH resources within the radio frame	8.4.0	8.5.0
03/12/08	RAN_42	RP-081074	84	6	Alignment of RAN1/RAN2 specification	8.4.0	8.5.0
03/12/08	RAN_42	RP-081074	86	-	Clarification on scrambling of ACK/NAK bits for PUCCH format 2a/2b	8.4.0	8.5.0
03/12/08	RAN_42	RP-081074	87	-	Correction of introduction of shortened SR	8.4.0	8.5.0
03/12/08	RAN_42	RP-081074	88	-	Corrections to 36.211	8.4.0	8.5.0
03/12/08	RAN_42	RP-081074	89	-	Clarification on PUSCH DM RS Cyclic Shift Hopping	8.4.0	8.5.0
03/12/08	RAN_42	RP-081074	92	1	Correction to the uplink DM RS assignment	8.4.0	8.5.0
03/12/08	RAN_42	RP-081074	93	-	Clarify the RNTI used in scrambling sequence initialization	8.4.0	8.5.0
03/12/08	RAN_42	RP-081074	94	1	On linkage Among UL Power Control Parameters	8.4.0	8.5.0
03/12/08	RAN_42	RP-081074	95	-	Clarification on PUSCH pre-determined hopping pattern	8.4.0	8.5.0
03/12/08	RAN_42	RP-081074	96	-	Clarification of SRS sequence-group and base sequence number	8.4.0	8.5.0
03/12/08	RAN_42	RP-081074	97	1	SRS subframe configuration	8.4.0	8.5.0
03/12/08	RAN_42	RP-081074	98	-	Remaining SRS details for TDD	8.4.0	8.5.0
03/12/08	RAN_42	RP-081074	99	-	Clarifying UL VRB Allocation	8.4.0	8.5.0
03/12/08	RAN_42	RP-081074	100	-	Clarification on PUCCH resource hopping	8.4.0	8.5.0
03/12/08	RAN_42	RP-081074	101	-	Correction for definition of Q _m and a pseudo code syntax error in Scrambling.	8.4.0	8.5.0
03/12/08	RAN_42	RP-081074	105	1	Remaining Issues on SRS of TDD	8.4.0	8.5.0
03/12/08	RAN_42	RP-081074	106	-	Correction of reference to RAN4 specification of supported uplink	8.4.0	8.5.0

Change history							
Date	TSG #	TSG Doc.	CR	Rev	Subject/Comment	Old	New
					bandwidth		
03/12/08	RAN_42	RP-081074	107	-	General corrections to SRS	8.4.0	8.5.0
03/12/08	RAN_42	RP-081074	109	2	Correction to PCFICH specification	8.4.0	8.5.0
03/12/08	RAN_42	RP-081074	110	1	Correction to Layer Mapping for Transmit Diversity with Four Antenna Ports	8.4.0	8.5.0
03/12/08	RAN_42	RP-081074	111	-	Correction of the mapping of cyclic shift field in DCI format 0 to the dynamic cyclic shift offset	8.4.0	8.5.0
03/12/08	RAN_42	RP-081074	112	-	DRS collision handling	8.4.0	8.5.0
03/12/08	RAN_42	RP-081074	113	-	Clarification to enable reuse of non-active PUCCH CQI RBs for PUSCH	8.4.0	8.5.0
03/12/08	RAN_42	RP-081074	114	1	PUSCH Mirror Hopping operation	8.4.0	8.5.0
03/12/08	RAN_42	RP-081074	108	1	Extended and normal cyclic prefix in DL and UL for LTE TDD	8.4.0	8.5.0
04/03/09	RAN_43	RP-090234	115	1	Alignment of PRACH configuration index for FS type 1 and type 2	8.5.0	8.6.0
04/03/09	RAN_43	RP-090234	118	1	Clarification for DRS Collision handling	8.5.0	8.6.0
04/03/09	RAN_43	RP-090234	121	1	Removing inverse modulo operation	8.5.0	8.6.0
04/03/09	RAN_43	RP-090234	123	1	Clarification on the use of preamble format 4	8.5.0	8.6.0
04/03/09	RAN_43	RP-090234	124	-	Clarification of RNTI used in scrambling sequence	8.5.0	8.6.0
04/03/09	RAN_43	RP-090234	125	1	Clarifying PDCCH RE mapping	8.5.0	8.6.0
04/03/09	RAN_43	RP-090234	126	-	Correction of preamble format 4 timing	8.5.0	8.6.0
04/03/09	RAN_43	RP-090234	127	2	Corrections to SRS	8.5.0	8.6.0
04/03/09	RAN_43	RP-090234	128	2	Clarification of PDSCH Mapping to Resource Elements	8.5.0	8.6.0
04/03/09	RAN_43	RP-090234	129	1	Alignment with correct ASN1 parameter names	8.5.0	8.6.0
04/03/09	RAN_43	RP-090234	130	-	Correction to PUCCH format 1 mapping to physical resources	8.5.0	8.6.0
04/03/09	RAN_43	RP-090234	132	-	Correction to type-2 PUSCH hopping	8.5.0	8.6.0
04/03/09	RAN_43	RP-090234	134	-	Alignment of SRS configuration	8.5.0	8.6.0
27/05/09	RAN_44	RP-090527	135	-	Correction on UE behavior for PRACH 20ms periodicity	8.6.0	8.7.0
15/09/09	RAN_45	RP-090888	137	1	Clarification on DMRS sequence for PUSCH	8.7.0	8.8.0
15/09/09	RAN_45	RP-090888	138	1	Correction to PHICH resource mapping for TDD and to PHICH scrambling	8.7.0	8.8.0
01/12/09	RAN_46	RP-091168	142	-	Clarification of the transmit condition for UE specific reference signals	8.8.0	8.9.0
01/12/09	RAN_46	RP-091172	139	2	Introduction of LTE positioning	8.9.0	9.0.0
01/12/09	RAN_46	RP-091177	140	3	Editorial corrections to 36.211	8.9.0	9.0.0
01/12/09	RAN_46	RP-091257	141	1	Introduction of enhanced dual layer transmission	8.9.0	9.0.0
16/03/10	RAN_47	RP-100209	144	1	Removal of square brackets on positioning subframe periodicities	9.0.0	9.1.0
16/03/10	RAN_47	RP-100209	145	-	Clarification of the CP length of empty OFDM symbols in PRS subframes	9.0.0	9.1.0
16/03/10	RAN_47	RP-100210	146	-	Clarification of MBSFN subframe definition	9.0.0	9.1.0
07/12/10	RAN_50	RP-101320	148	-	Introduction of Rel-10 LTE-Advanced features in 36.211	9.1.0	10.0.0
15/03/11	RAN_51	RP-110254	149	1	Correction on UE behavior for PRACH preamble format 4	10.0.0	10.1.0
15/03/11	RAN_51	RP-110256	150	-	Corrections to Rel-10 LTE-Advanced features in 36.211	10.0.0	10.1.0
01/06/11	RAN_52	RP-110818	153	2	PUSCH interaction with periodic SRS	10.1.0	10.2.0
01/06/11	RAN_52	RP-110819	154	1	Correction on describing PUCCH format 3	10.1.0	10.2.0
01/06/11	RAN_52	RP-110821	155	3	Correction on codebooks for CSI-RS based feedback for up to 4 CSI-RS ports.	10.1.0	10.2.0
01/06/11	RAN_52	RP-110821	156	-	Correction on overlapping non-zero-power and zero-power CSI-RS configurations	10.1.0	10.2.0
01/06/11	RAN_52	RP-110821	157	-	Correction on CSI-RS configuration	10.1.0	10.2.0
01/06/11	RAN_52	RP-110821	158	-	PDSCH transmission in MBSFN subframes	10.1.0	10.2.0
01/06/11	RAN_52	RP-110823	159	-	Correction on implicit derivation of transmission comb per antenna port for SRS	10.1.0	10.2.0
01/06/11	RAN_52	RP-110823	160	-	Uplink DMRS sequence in RACH procedure	10.1.0	10.2.0
15/09/11	RAN_53	RP-111229	162	-	Corrections on DMRS for Extended CP	10.2.0	10.3.0
15/09/11	RAN_53	RP-111228	163	-	Clarification of applicability of precoding power scaling factors for PDSCH	10.2.0	10.3.0
15/09/11	RAN_53	RP-111228	164	-	Correction to modulation and upconversion on PRACH	10.2.0	10.3.0
15/09/11	RAN_53	RP-111229	165	-	Clarification on cyclic prefix of PDSCH in MBSFN subframes	10.2.0	10.3.0
15/09/11	RAN_53	RP-111229	166	3	Corrections on indication in scrambling identity field in DCI format 2B and 2C	10.2.0	10.3.0
05/12/11	RAN_54	RP-111668	167	-	A correction to PDSCH precoding for CQI calculation	10.3.0	10.4.0
05/12/11	RAN_54	RP-111668	168	-	Correction to figure of CSI-RS pattern in extended-CP subframe	10.3.0	10.4.0
13/06/12	RAN_56	RP-120736	169	-	Correction to resource mapping for PDSCH	10.4.0	10.5.0
13/06/12	RAN_56	RP-120739	171	-	Correction for DMRS group hopping and sequence hopping	10.4.0	10.5.0
13/06/12	RAN_56	RP-120738	172	-	Correction to assumed CSI-RS transmissions in subframes used for paging	10.4.0	10.5.0
04/09/12	RAN_57	RP-121274	170	4	Introduction of an additional special subframe configuration	10.5.0	11.0.0
04/09/12	RAN_57	RP-121272	173	-	Inclusion of Rel-11 features	10.5.0	11.0.0
04/12/12	RAN_58	RP-121839	175	-	Correction to assumed CSI-RS transmissions in secondary cells	11.0.0	11.1.0
04/12/12	RAN_58	RP-121846	176	-	Correction to assumed CSI-RS transmissions in secondary cells	11.0.0	11.1.0
26/02/13	RAN_59	RP-130254	178	-	Clarification of CSI RS mapping to resource elements	11.1.0	11.2.0
26/02/13	RAN_59	RP-130254	180	-	Correction to CSI Reference Signals	11.1.0	11.2.0

Change history							
Date	TSG #	TSG Doc.	CR	Rev	Subject/Comment	Old	New
26/02/13	RAN_59	RP-130255	181	-	Additional clarifications/corrections for introducing Rel-11 features	11.1.0	11.2.0
11/06/13	RAN_60	RP-130752	182	-	Correction to EPDCCH PRB pair indication	11.2.0	11.3.0
11/06/13	RAN_60	RP-130752	183	-	CR on collision between EPDCCH and PSS/SSS/PBCH	11.2.0	11.3.0

History

Document history		
V11.0.0	October 2012	Publication
V11.1.0	February 2013	Publication
V11.2.0	April 2013	Publication
V11.3.0	July 2013	Publication