

ETSI TS 136 323 V8.3.0 (2008-11)

Technical Specification

**LTE;
Evolved Universal Terrestrial Radio Access (E-UTRA);
Packet Data Convergence Protocol (PDCP) specification
(3GPP TS 36.323 version 8.3.0 Release 8)**



Reference

RTS/TSGR-0236323v830

Keywords

LTE

ETSI

650 Route des Lucioles
F-06921 Sophia Antipolis Cedex - FRANCE

Tel.: +33 4 92 94 42 00 Fax: +33 4 93 65 47 16

Siret N° 348 623 562 00017 - NAF 742 C
Association à but non lucratif enregistrée à la
Sous-Préfecture de Grasse (06) N° 7803/88

Important notice

Individual copies of the present document can be downloaded from:

<http://www.etsi.org>

The present document may be made available in more than one electronic version or in print. In any case of existing or perceived difference in contents between such versions, the reference version is the Portable Document Format (PDF). In case of dispute, the reference shall be the printing on ETSI printers of the PDF version kept on a specific network drive within ETSI Secretariat.

Users of the present document should be aware that the document may be subject to revision or change of status. Information on the current status of this and other ETSI documents is available at

<http://portal.etsi.org/tb/status/status.asp>

If you find errors in the present document, please send your comment to one of the following services:

http://portal.etsi.org/chaicor/ETSI_support.asp

Copyright Notification

No part may be reproduced except as authorized by written permission.
The copyright and the foregoing restriction extend to reproduction in all media.

© European Telecommunications Standards Institute 2008.
All rights reserved.

DECTTM, **PLUGTESTS**TM, **UMTS**TM, **TIPHON**TM, the TIPHON logo and the ETSI logo are Trade Marks of ETSI registered for the benefit of its Members.

3GPPTM is a Trade Mark of ETSI registered for the benefit of its Members and of the 3GPP Organizational Partners.

Intellectual Property Rights

IPRs essential or potentially essential to the present document may have been declared to ETSI. The information pertaining to these essential IPRs, if any, is publicly available for **ETSI members and non-members**, and can be found in ETSI SR 000 314: "*Intellectual Property Rights (IPRs); Essential, or potentially Essential, IPRs notified to ETSI in respect of ETSI standards*", which is available from the ETSI Secretariat. Latest updates are available on the ETSI Web server (<http://webapp.etsi.org/IPR/home.asp>).

Pursuant to the ETSI IPR Policy, no investigation, including IPR searches, has been carried out by ETSI. No guarantee can be given as to the existence of other IPRs not referenced in ETSI SR 000 314 (or the updates on the ETSI Web server) which are, or may be, or may become, essential to the present document.

Foreword

This Technical Specification (TS) has been produced by ETSI 3rd Generation Partnership Project (3GPP).

The present document may refer to technical specifications or reports using their 3GPP identities, UMTS identities or GSM identities. These should be interpreted as being references to the corresponding ETSI deliverables.

The cross reference between GSM, UMTS, 3GPP and ETSI identities can be found under <http://webapp.etsi.org/key/queryform.asp>.

Contents

Intellectual Property Rights	2
Foreword.....	2
Foreword.....	5
1 Scope	6
2 References	6
3 Definitions and abbreviations.....	6
3.1 Definitions	6
3.2 Abbreviations	7
4 General	7
4.1 Introduction	7
4.2 PDCP architecture	7
4.2.1 PDCP structure	7
4.2.2 PDCP entities.....	8
4.3 Services	9
4.3.1 Services provided to upper layers.....	9
4.3.2 Services expected from lower layers	9
4.4 Functions	10
4.5 Data available for transmission	10
5 PDCP procedures	10
5.1 PDCP Data Transfer Procedures	10
5.1.1 UL Data Transfer Procedures	10
5.1.2 DL Data Transfer Procedures	11
5.1.2.1 Procedures for DRBs.....	11
5.1.2.1.1 In-order delivery and duplicate elimination.....	12
5.1.2.2 Procedures for SRBs	13
5.2 PDCP Actions related to Handover	13
5.2.1 UL Data Transfer Procedures	13
5.2.1.1 Procedures for DRBs mapped on RLC AM.....	13
5.2.1.2 Procedures for DRBs mapped on RLC UM.....	14
5.2.1.3 Procedures for SRBs	14
5.2.2 DL Data Transfer Procedures	14
5.2.2.1 Procedures for DRBs mapped on RLC AM.....	14
5.2.2.2 Procedures for DRBs mapped on RLC UM.....	14
5.2.2.3 Procedures for SRBs	14
5.3 PDCP Status Report	15
5.3.1 Transmit operation.....	15
5.3.2 Receive operation	15
5.4 PDCP discard	15
5.5 Header Compression and Decompression.....	15
5.5.1 Supported header compression protocols and profiles.....	15
5.5.2 Configuration of header compression	16
5.5.3 Protocol parameters	16
5.5.4 Header compression.....	17
5.5.5 Header decompression.....	17
5.6 Cipherring and Decipherring.....	17
5.7 Integrity Protection and Verification	17
5.8 Handling of unknown, unforeseen and erroneous protocol data	18
6 Protocol data units, formats and parameters.....	18
6.1 Protocol data units	18
6.1.1 PDCP Data PDU.....	18
6.1.2 PDCP Control PDU	18
6.2 Formats.....	18

6.2.1	General.....	18
6.2.2	Control plane PDCP Data PDU SRBs	19
6.2.3	User plane PDCP Data PDU with long PDCP SN (12 bits)	19
6.2.4	User plane PDCP Data PDU with short PDCP SN (7 bits)	19
6.2.5	PDCP Control PDU for interspersed ROHC feedback packet.....	20
6.2.6	PDCP Control PDU for PDCP status report	20
6.2.7	PDCP Data PDU for u-plane data over MBSFN (FFS).....	20
6.3	Parameters	21
6.3.1	General.....	21
6.3.2	PDCP SN	21
6.3.3	Data.....	21
6.3.4	MAC-I	21
6.3.5	COUNT	21
6.3.6	R	21
6.3.7	D/C.....	22
6.3.8	PDU type	22
6.3.9	FMS	22
6.3.10	Bitmap	22
6.3.11	Interspersed ROHC feedback packet	23
7	Variables, constants and timers	23
7.1	State variables	23
7.2	Timers	23
7.3	Constants	24
Annex A (informative): Change history		25
History		26

Foreword

This Technical Specification has been produced by the 3rd Generation Partnership Project (3GPP).

The contents of the present document are subject to continuing work within the TSG and may change following formal TSG approval. Should the TSG modify the contents of the present document, it will be re-released by the TSG with an identifying change of release date and an increase in version number as follows:

Version x.y.z

where:

- x the first digit:
 - 1 presented to TSG for information;
 - 2 presented to TSG for approval;
 - 3 or greater indicates TSG approved document under change control.
- y the second digit is incremented for all changes of substance, i.e. technical enhancements, corrections, updates, etc.
- z the third digit is incremented when editorial only changes have been incorporated in the document.

1 Scope

The present document provides the description of the Packet Data Convergence Protocol (PDCP).

2 References

The following documents contain provisions which, through reference in this text, constitute provisions of the present document.

- References are either specific (identified by date of publication, edition number, version number, etc.) or non-specific.
- For a specific reference, subsequent revisions do not apply.
- For a non-specific reference, the latest version applies. In the case of a reference to a 3GPP document (including a GSM document), a non-specific reference implicitly refers to the latest version of that document *in the same Release as the present document*.

- [1] 3GPP TR 21.905: "Vocabulary for 3GPP Specifications".
- [2] 3GPP TS 36.300: "Evolved Universal Terrestrial Radio Access (E-UTRA) and Evolved Universal Terrestrial Radio Access Network (E-UTRAN); Overall description".
- [3] 3GPP TS 36.331: "Evolved Universal Terrestrial Radio Access (E-UTRA) Radio Resource Control (RRC); Protocol Specification".
- [4] 3GPP TS 36.321: "Evolved Universal Terrestrial Radio Access (E-UTRA) Medium Access Control (MAC) protocol specification".
- [5] 3GPP TS 36.322: "Evolved Universal Terrestrial Radio Access (E-UTRA) Radio Link Control (RLC) protocol specification".
- [6] 3GPP TS 33.401: "3GPP System Architecture Evolution: Security Architecture".
- [7] IETF RFC 4995: "The RObust Header Compression (ROHC) Framework".
- [8] IETF RFC 4996: "RObust Header Compression (ROHC): A Profile for TCP/IP (ROHC-TCP)".
- [9] IETF RFC 3095: "RObust Header Compression (ROHC): Framework and four profiles: RTP, UDP, ESP and uncompressed".
- [10] IETF RFC 3843: "RObust Header Compression (ROHC): A Compression Profile for IP".
- [11] IETF RFC 4815: "RObust Header Compression (ROHC): Corrections and Clarifications to RFC 3095".
- [12] IETF RFC 5225: "RObust Header Compression (ROHC) Version 2: Profiles for RTP, UDP, IP, ESP and UDP Lite".

3 Definitions and abbreviations

3.1 Definitions

For the purposes of the present document, the terms and definitions given in TR 21.905 [1] and the following apply. A term defined in the present document takes precedence over the definition of the same term, if any, in TR 21.905 [1].

3.2 Abbreviations

For the purposes of the present document, the abbreviations given in TR 21.905 [1] and the following apply. An abbreviation defined in the present document takes precedence over the definition of the same abbreviation, if any, in TR 21.905 [1].

AM	Acknowledged Mode
CID	Context Identifier
DRB	Data Radio Bearer carrying user plane data
EPS	Evolved Packet System
E-UTRA	Evolved UMTS Terrestrial Radio Access
E-UTRAN	Evolved UMTS Terrestrial Radio Access Network
eNB	evolved Node B
FMS	First missing PDCP SN
HFN	Hyper Frame Number
IETF	Internet Engineering Task Force
IP	Internet Protocol
L2	Layer 2 (data link layer)
L3	Layer 3 (network layer)
MAC	Message Authentication Code
MBMS	Multimedia Broadcast / Multicast Service
PDCP	Packet Data Convergence Protocol
PDU	Protocol Data Unit
R	Reserved
RB	Radio Bearer
RFC	Request For Comments
RLC	Radio Link Control
ROHC	RObust Header Compression
RRC	Radio Resource Control
RTP	Real Time Protocol
SAP	Service Access Point
SDU	Service Data Unit
SN	Sequence Number
SRB	Signalling Radio Bearer carrying control plane data
TCP	Transmission Control Protocol
UDP	User Datagram Protocol
UE	User Equipment
UM	Unacknowledged Mode
X-MAC	Computed MAC-I

4 General

4.1 Introduction

The present document describes the functionality of the PDCP.

4.2 PDCP architecture

4.2.1 PDCP structure

Figure 4.2.1.1 represents one possible structure for the PDCP sublayer; it should not restrict implementation. The figure is based on the radio interface protocol architecture defined in [2].

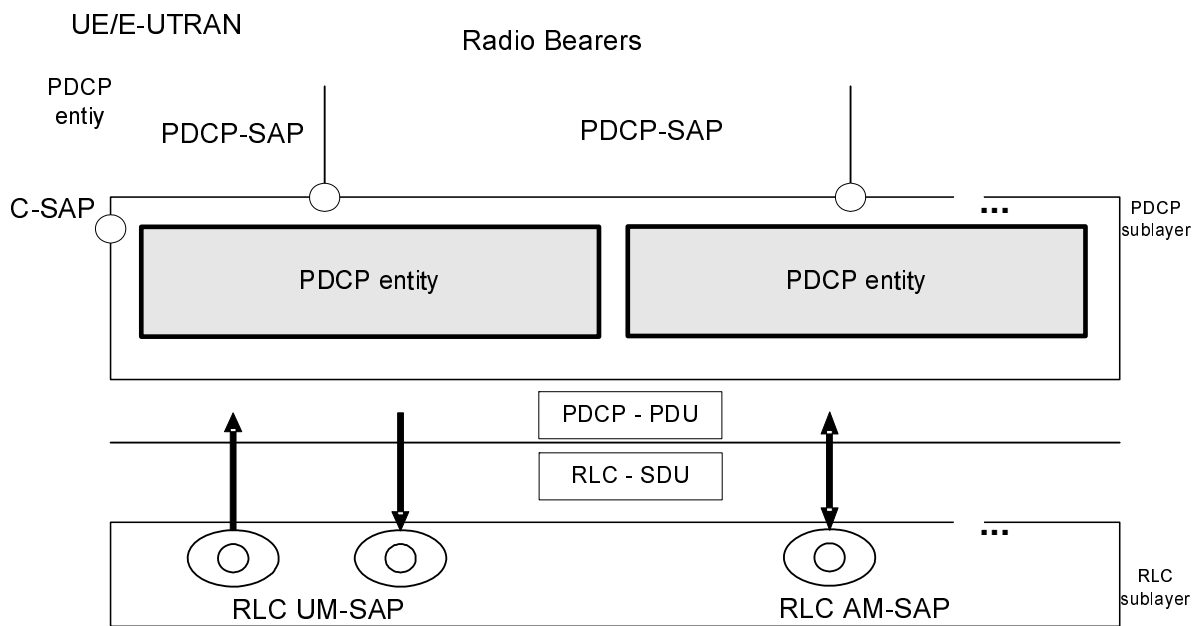

Figure 4.2.1.1 - PDCP layer, structure view

Every EPS bearer is associated with one RB, which in turn is associated with one PDCP entity.

Each PDCP entity is associated with one or two (one for each direction) RLC entities depending on the RB characteristic (i.e. uni-directional or bi-directional) and RLC mode. The PDCP entities are located in the PDCP sublayer.

The PDCP sublayer is configured by upper layers [3].

4.2.2 PDCP entities

The PDCP entities are located in the PDCP sublayer. Several PDCP entities may be defined for a UE. Each PDCP entity carrying user plane data may be configured to use header compression.

Each PDCP entity is carrying the data of one radio bearer. In this version of the specification, only the robust header compression protocol (ROHC), is supported. Every PDCP entity uses at most one ROHC instance.

A PDCP entity is associated either to the control plane or the user plane depending on which radio bearer it is carrying data for.

Figure 4.2.2.1 represents the functional view of the PDCP entity for the PDCP sublayer; it should not restrict implementation. The figure is based on the radio interface protocol architecture defined in [2].

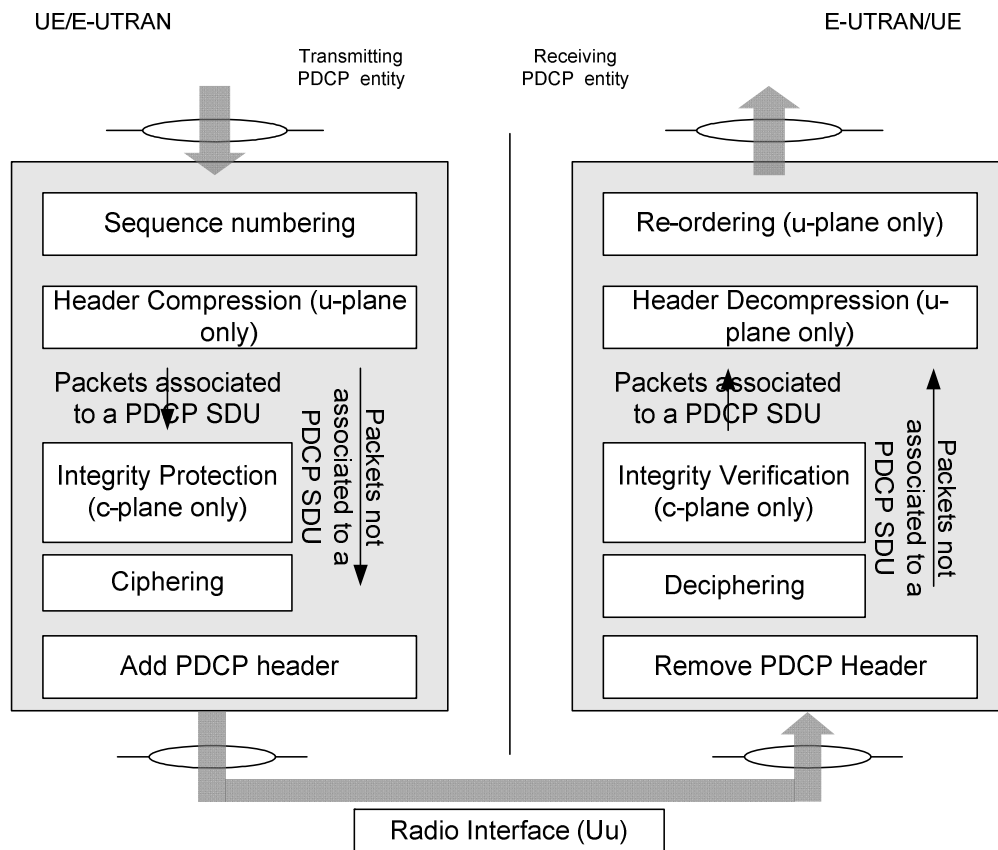

Figure 4.2.2.1 - PDCP layer, functional view

4.3 Services

4.3.1 Services provided to upper layers

PDCP provides its services to the RRC and user plane upper layers at the UE or to the relay at the evolved Node B (eNB). The following services are provided by PDCP to upper layers:

- transfer of user plane data;
- transfer of control plane data;
- header compression;
- cipherring;
- integrity protection.

4.3.2 Services expected from lower layers

For a detailed description of the following functions see [5].

- acknowledged data transfer service, including indication of successful delivery of PDCP PDUs;
- unacknowledged data transfer service;
- in-sequence delivery, except at handover;
- duplicate discarding, except at handover.

4.4 Functions

The Packet Data Convergence Protocol supports the following functions:

- header compression and decompression of IP data flows using the ROHC protocol, at the transmitting and receiving entity, respectively;
- transfer of data (user plane or control plane). This function is used for conveyance of data between users of PDCP services;
- maintenance of PDCP SNs for radio bearers mapped on RLC AM;
- in-sequence delivery of upper layer PDUs at handover;
- duplicate elimination of lower layer SDUs at handover for radio bearers mapped on RLC AM;
- ciphering and deciphering of user plane data and control plane data;
- integrity protection and integrity verification of control plane data;
- timer based discard;
- duplicate discarding.

PDCP uses the services provided by the RLC sublayer.

PDCP is used for SRBs and DRBs mapped on DCCH and DTCH type of logical channels. PDCP is not used for any other type of logical channels.

4.5 Data available for transmission

For the purpose of MAC buffer status reporting, the UE shall consider the following as data available for transmission in the PDCP layer:

For SDUs for which no PDU has been submitted to lower layers:

- the SDU itself, if the SDU has not yet been processed by PDCP, or
- the PDU (control or data) if the SDU has been processed by PDCP.

In addition, for radio bearers that are mapped on RLC AM, if the PDCP entity has previously received an indication from upper layer that a handover has occurred, the UE shall also consider the following as data available for transmission in the PDCP layer:

For SDUs for which a corresponding PDU has only been submitted to lower layers before PDCP has received an indication that a handover has occurred, and for which the successful delivery has not been confirmed by lower layers or by a PDCP status report:

- the SDU, if it has not yet been processed by PDCP, or
- the PDU (data only) once it has been processed by PDCP.

5 PDCP procedures

5.1 PDCP Data Transfer Procedures

5.1.1 UL Data Transfer Procedures

At reception of a PDCP SDU from upper layers, the UE shall:

- associate the PDCP SN corresponding to Next_PDCP_TX_SN to this PDCP SDU;

- start the Discard_Timer associated with this PDCP SDU (if configured);
- perform header compression of the PDCP SDU (if configured) as specified in the subclause 5.5.4;
- perform integrity protection (if applicable), and ciphering (if applicable) using COUNT based on TX_HFN and the PDCP SN associated with this PDCP SDU as specified in the subclause 5.7 and 5.6, respectively;
- increment Next_PDCP_TX_SN by one;
- if Next_PDCP_TX_SN > Maximum_PDCP_SN:
 - set Next_PDCP_TX_SN to 0;
 - increment TX_HFN by one;
- submit the resulting PDCP Data PDU to lower layer.

5.1.2 DL Data Transfer Procedures

5.1.2.1 Procedures for DRBs

For DRBs mapped on RLC AM and if the Flush_Timer is not running, or for DRBs mapped on RLC UM, at reception of a PDCP Data PDU from lower layers, the UE shall:

- if received PDCP SN < Next_PDCP_RX_SN:
 - increment RX_HFN by one;
- decipher the PDCP Data PDU using COUNT based on RX_HFN and the received PDCP SN as specified in the subclause 5.6;
- if the DRB is mapped on RLC AM:
 - set Last_Submitted_PDCP_RX_SN to the received PDCP SN;
- set Next_PDCP_RX_SN to the received PDCP SN + 1;
- if Next_PDCP_RX_SN > Maximum_PDCP_SN:
 - set Next_PDCP_RX_SN to 0;
 - increment RX_HFN by one;
- perform header decompression (if configured) of the deciphered PDCP Data PDU as specified in the subclause 5.5.5;
- deliver the resulting PDCP SDU to upper layer.

For DRBs mapped on RLC AM and if the Flush_Timer is running, at reception of a PDCP Data PDU from lower layers other than the PDU received due to the re-establishment of lower layers, the UE shall:

- process the PDCP Data PDU as specified in the subclause 5.1.2.1.1;
- deliver to upper layers in ascending order of the associated COUNT value:
 - all stored PDCP SDU(s) with an associated COUNT value less than or equal to the COUNT value associated with the received PDCP SDU;
 - all stored PDCP SDU(s) with consecutive associated COUNT value(s) starting from the COUNT value associated with the received PDCP SDU + 1, if any;
- set Last_Submitted_PDCP_RX_SN to the PDCP SN of the last PDCP SDU delivered to upper layers.

For DRBs mapped on RLC AM, upon expiry of the Flush_Timer, the UE shall:

- deliver all stored PDCP SDUs in ascending order of the associated COUNT values to upper layers;

- set Last_Submitted_PDCP_RX_SN to the PDCP SN of the last PDCP SDU that was delivered to the upper layers.

5.1.2.1.1 In-order delivery and duplicate elimination

At reception of a PDCP Data PDU from lower layers, the UE shall:

- if received PDCP SN – Last_Submitted_PDCP_RX_SN > Reordering_Window or $0 \leq \text{Last_Submitted_PDCP_RX_SN} - \text{received PDCP SN} < \text{Reordering_Window}$:
 - if received PDCP SN > Next_PDCP_RX_SN:
 - decipher the PDCP PDU as specified in the subclause 5.6, using COUNT based on RX_HFN - 1 and the received PDCP SN;
 - else:
 - decipher the PDCP PDU as specified in the subclause 5.6, using COUNT based on RX_HFN and the received PDCP SN;
 - perform header decompression (if configured) as specified in the subclause 5.5.5;
 - discard this PDCP SDU;
- else if Next_PDCP_RX_SN – received PDCP SN > Reordering_Window:
 - increment RX_HFN by one;
 - use COUNT based on RX_HFN and the received PDCP SN for deciphering the PDCP PDU;
 - set Next_PDCP_RX_SN to the received PDCP SN + 1;
- else if received PDCP SN – Next_PDCP_RX_SN > Reordering_Window:
 - use COUNT based on RX_HFN – 1 and the received PDCP SN for deciphering the PDCP PDU;
- else if received PDCP SN \geq Next_PDCP_RX_SN:
 - use COUNT based on RX_HFN and the received PDCP SN for deciphering the PDCP PDU;
 - set Next_PDCP_RX_SN to the received PDCP SN + 1;
 - if Next_PDCP_RX_SN is larger than Maximum_PDCP_SN:
 - set Next_PDCP_RX_SN to 0;
 - increment RX_HFN by one;
- else if received PDCP SN < Next_PDCP_RX_SN:
 - use COUNT based on RX_HFN and the received PDCP SN for deciphering the PDCP PDU;
- if the PDCP PDU has not been discarded in the above:
 - perform deciphering and header decompression (if configured) for the PDCP PDU as specified in the subclauses 5.6 and 5.5.5, respectively;
 - if a PDCP SDU with the same PDCP SN is stored:
 - discard this PDCP SDU;
 - else:
 - store the PDCP SDU for later delivery.

5.1.2.2 Procedures for SRBs

For SRBs, at reception of a PDCP Data PDU from lower layers, the UE shall:

- if received PDCP SN < Next_PDCP_RX_SN:
 - decipher and verify the integrity of the PDU (if applicable) using COUNT based on RX_HFN + 1 and the received PDCP SN as specified in the subclauses 5.6 and 5.7, respectively;
- else:
 - decipher and verify the integrity of the PDU (if applicable) using COUNT based on RX_HFN and the received PDCP SN as specified in the subclauses 5.6 and 5.7, respectively;
- if integrity verification is applicable and the integrity verification is passed successfully; or
- if integrity verification is not applicable:
 - if received PDCP SN < Next_PDCP_RX_SN:
 - increment RX_HFN by one;
 - set Next_PDCP_RX_SN to the received PDCP SN + 1;
 - if Next_PDCP_RX_SN > Maximum_PDCP_SN:
 - set Next_PDCP_RX_SN to 0;
 - increment RX_HFN by one;
 - deliver the resulting PDCP SDU to upper layer;
- else, if integrity verification is applicable and the integrity verification fails:
 - discard the received PDCP Data PDU;
 - indicate the integrity verification failure to upper layer.

5.2 PDCP Actions related to Handover

Upon reception of a handover indication from upper layers, the UE shall additionally perform once the procedures described in this section. After performing the procedures in this section, the UE shall follow the procedures in the section 5.1.

5.2.1 UL Data Transfer Procedures

5.2.1.1 Procedures for DRBs mapped on RLC AM

When upper layers indicate that a handover has occurred, the UE shall:

- reset the header compression protocol for uplink (if configured);
- apply the ciphering algorithm and key provided by upper layers during the handover procedure;
- from the first PDCP SDU for which the successful delivery of the corresponding PDCP PDU has not been confirmed by lower layers, perform retransmission or transmission of all the PDCP SDUs already associated with PDCP SNs in ascending order of the COUNT values associated to the PDCP SDU prior to the handover indication as specified below:
 - perform header compression of the PDCP SDU (if configured) as specified in the subclause 5.5.4;
 - perform ciphering of the PDCP SDU using the COUNT value associated with this PDCP SDU as specified in the subclause 5.6;

- submit the resulting PDCP Data PDU to lower layer.

5.2.1.2 Procedures for DRBs mapped on RLC UM

When upper layers indicate that a handover has occurred, the UE shall:

- reset the header compression protocol for uplink (if configured);
- set Next_PDCP_TX_SN, and TX_HFN to 0;
- apply the ciphering algorithm and key provided by upper layers during the handover procedure;
- for each PDCP SDU already associated with a PDCP SN but for which a corresponding PDU has not previously been submitted to lower layers:
 - consider the PDCP SDUs as received from upper layer;
 - perform transmission of the PDCP SDUs in ascending order of the COUNT value associated to the PDCP SDU prior to the handover indication, as specified in the subclause 5.1.1 without restarting the Discard_Timer.

5.2.1.3 Procedures for SRBs

When upper layers indicate that a handover has occurred, the UE shall:

- set Next_PDCP_TX_SN, and TX_HFN to 0;
- discard all stored PDCP SDUs and PDCP PDUs;
- apply the ciphering and integrity algorithm and keys provided by upper layers during the handover procedure.

5.2.2 DL Data Transfer Procedures

5.2.2.1 Procedures for DRBs mapped on RLC AM

When upper layers indicate that a handover has occurred, the UE shall:

- start the Flush_Timer, or restart if already running;
- process the PDCP Data PDUs that are received from lower layers due to the re-establishment of the lower layers, as specified in the subclause 5.1.2.1.1;
- reset the header compression protocol for downlink (if configured);
- apply the ciphering algorithm and key provided by upper layers during the handover procedure.

5.2.2.2 Procedures for DRBs mapped on RLC UM

When upper layers indicate that a handover has occurred, the UE shall:

- process the PDCP Data PDUs that are received from lower layers due to the re-establishment of the lower layers, as specified in the subclause 5.1.2.1;
- reset the header compression protocol for downlink (if configured);
- set Next_PDCP_RX_SN, and RX_HFN to 0;
- apply the ciphering algorithm and key provided by upper layers during the handover procedure.

5.2.2.3 Procedures for SRBs

When upper layers indicate that a handover has occurred, the UE shall:

- set Next_PDCP_RX_SN, and RX_HFN to 0;
- discard all stored PDCP SDUs and PDCP PDUs;
- apply the ciphering and integrity protection algorithm and keys provided by upper layers during the handover procedure.

5.3 PDCP Status Report

5.3.1 Transmit operation

When upper layers indicate that a handover has occurred, for radio bearers that are mapped on RLC AM, the UE shall:

- if the radio bearer is configured by upper layers to send a PDCP status report in the uplink, and if the Flush_Timer is running, compile a status report as indicated below after processing the PDCP Data PDUs that are received from lower layers due to the re-establishment of the lower layers as specified in the subclause 5.2.2.1, and submit it to lower layers as the first PDCP PDU for the transmission, by:
 - setting the FMS field to the PDCP SN of the first missing PDCP SDU;
 - if there are more than one missing PDCP SDUs, allocating a Bitmap field of length in bits equal to the number of PDCP SNs from and not including the first missing PDCP SDU up to and including the last out-of-sequence PDCP SDUs, rounded up to the next multiple of 8;
 - setting as "0" in the corresponding position in the bitmap field for all PDCP SDUs that have not been received as indicated by lower layers, and optionally PDCP SDUs for which decompression have failed;
 - indicating in the bitmap field as "1" for all other PDCP SDUs.

5.3.2 Receive operation

When a PDCP status report is received in the downlink while the Flush_Timer is running, for radio bearers that are mapped on RLC AM:

- for each PDCP SDU, if any, with the bit in the bitmap set to '1', or with the associated COUNT value less than the COUNT value of the PDCP SDU identified by the FMS field, the successful delivery of the corresponding PDCP SDU is confirmed, and the UE shall process the PDCP SDU as specified in the subclause 5.4.

5.4 PDCP discard

When the Discard_Timer expires for a PDCP SDU, or the successful delivery of a PDCP SDU is confirmed by PDCP status report, the UE shall discard the PDCP SDU along with the corresponding PDCP PDU. If the corresponding PDCP PDU has already been submitted to lower layers the discard is indicated to lower layers.

5.5 Header Compression and Decompression

5.5.1 Supported header compression protocols and profiles

The header compression protocol is based on the Robust Header Compression (ROHC) framework [7]. There are multiple header compression algorithms, called profiles, defined for the ROHC framework. Each profile is specific to the particular network layer, transport layer or upper layer protocol combination e.g. TCP/IP and RTP/UDP/IP.

The detailed definition of the ROHC channel is specified as part of the ROHC framework in RFC 4995 [7]. This includes how to multiplex different flows (header compressed or not) over the ROHC channel, as well as how to associate a specific IP flow with a specific context state during initialization of the compression algorithm for that flow.

The implementation of the functionality of the ROHC framework and of the functionality of the supported header compression profiles is not covered in this specification.

In this version of the specification the support of the following profiles is described:

Table 5.5.1.1: Supported header compression protocols and profiles

Profile Identifier	Usage:	Reference
0x0000	No compression	RFC 4995
0x0001	RTP/UDP/IP	RFC 3095, RFC 4815
0x0002	UDP/IP	RFC 3095, RFC 4815
0x0003	ESP/IP	RFC 3095, RFC 4815
0x0004	IP	RFC 3843, RFC 4815
0x0006	TCP/IP	RFC 4996
0x0101	RTP/UDP/IP	RFC 5225
0x0102	UDP/IP	RFC 5225
0x0103	ESP/IP	RFC 5225
0x0104	IP	RFC 5225

5.5.2 Configuration of header compression

PDCP entities associated with DRBs can be configured by upper layers [3] to use header compression.

5.5.3 Protocol parameters

RFC 4995 has configuration parameters that are mandatory and that must be configured by upper layers between compressor and decompressor peers [7]; these parameters define the ROHC channel. The ROHC channel is a unidirectional channel, i.e. there is one channel for the downlink, and one for the uplink. There is thus one set of parameters for each channel, and the same values shall be used for both channels belonging to the same PDCP.

These parameters are categorized in two different groups, as defined below:

- M: Mandatory and configured by upper layers.
- N/A: Not used in this specification.

The usage and definition of the parameters shall be as specified below.

- MAX_CID (M): This is the maximum CID value that can be used. One CID value shall always be reserved for uncompressed flows.
- LARGE_CIDS: This value is not configured by upper layers, but rather it is inferred from the configured value of MAX_CID according to the following rule:

If MAX_CID > 15 then LARGE_CIDS = TRUE else LARGE_CIDS = FALSE.
- PROFILES (M): Profiles are used to define which profiles are allowed to be used by the UE in uplink. The list of supported profiles is described in section 5.5.1.
- FEEDBACK_FOR (N/A): This is a reference to the channel in the opposite direction between two compression endpoints and indicates to what channel any feedback sent refers to. Feedback received on one ROHC channel for this PDCP shall always refer to the ROHC channel in the opposite direction for this same PDCP.
- MRRU (N/A): ROHC segmentation is not used.

5.5.4 Header compression

The header compression protocol generates two types of output packets:

- compressed packets, each associated with one PDCP SDU
- standalone packets not associated with a PDCP SDU, i.e. interspersed ROHC feedback packets

A compressed packet is associated with the same PDCP SN and COUNT value as the related PDCP SDU.

Interspersed ROHC feedback packets are not associated with a PDCP SDU. They are not associated with a PDCP SN and are not ciphered.

5.5.5 Header decompression

If header compression is configured by upper layers for PDCP entities associated with u-plane data the PDCP PDUs are de-compressed by the header compression protocol after performing deciphering as explained in the subclause 5.6.

5.6 Ciphering and Deciphering

The ciphering function includes both ciphering and deciphering and is performed in PDCP. For the control plane, the data unit that is ciphered is the data part of the PDCP PDU (see subclause 6.3.3) and the MAC-I (see subclause 6.3.4). For the user plane, the data unit that is ciphered is the data part of the PDCP PDU (see subclause 6.3.3); ciphering is not applicable to PDCP Control PDUs.

The ciphering algorithm and key to be used by the PDCP entity are configured by upper layers [3] and the ciphering method shall be applied as specified in [6].

The ciphering function is activated by upper layers [3]. After security activation, the ciphering function shall be applied to all PDCP PDUs indicated by upper layers [3] for the downlink and the uplink, respectively.

The parameters that are required by PDCP for ciphering are defined in [6] and are input to the ciphering algorithm. The COUNT value is used as one of the input to the ciphering function. The parameters required by PDCP which are provided by upper layers [3] are listed below:

- BEARER (defined as the radio bearer identifier in [5]. It will use the value RB identity -1 as in [3]);
- DIRECTION (direction of the transmission: 0 for uplink, 1 for downlink);
- KEY (the ciphering keys for the control plane and for the user plane are $K_{RRCCenc}$ and K_{UPenc} , respectively).

Editors note: It is FFS how keys can be changed if necessary without transiting through idle mode.

5.7 Integrity Protection and Verification

The integrity protection function includes both integrity protection and integrity verification and is performed in PDCP for PDCP entities associated with SRBs. The data unit that is integrity protected is the PDU header and the data part of the PDU before ciphering.

The integrity protection algorithm and key to be used by the PDCP entity are configured by upper layers [3] and the integrity protection method shall be applied as specified in [6].

The integrity protection function is activated by upper layers [3]. After security activation, the integrity protection function shall be applied to all PDUs including and subsequent to the PDU indicated by upper layers [3] for the downlink and the uplink, respectively.

NOTE: As the RRC message which activates the integrity protection function is itself integrity protected with the configuration included in this RRC message, this message needs first be decoded by RRC before the integrity protection verification could be performed for the PDU in which the message was received.

The parameters that are required by PDCP for integrity protection are defined in [6] and are input to the integrity protection algorithm. The COUNT value is used as one of the input to the integrity protection function. The parameters required by PDCP which are provided by upper layers [3] are listed below:

- BEARER (defined as the radio bearer identifier in [6]. It will use the value RB identity –1 as in [3]);
- DIRECTION (direction of the transmission: 0 for uplink, 1 for downlink);
- KEY (K_{RRCint}).

At transmission, the UE computes the value of the MAC-I field and at reception it verifies the integrity of the PDCP PDU by calculating the X-MAC based on the input parameters as specified above. If the calculated X-MAC corresponds to the received MAC-I, integrity protection is verified successfully.

5.8 Handling of unknown, unforeseen and erroneous protocol data

Editors note: The subsection on "Handling of unknown, unforeseen and erroneous protocol data" should be the last subsection of Section "PDCP procedures".

Editors note: There is no clause defined at this point. FFS if anything related to security can be relevant here.

6 Protocol data units, formats and parameters

6.1 Protocol data units

6.1.1 PDCP Data PDU

The PDCP Data PDU is used to convey:

- a PDCP SDU SN; and
- user plane data containing an uncompressed PDCP SDU; or
- user plane data containing a compressed PDCP SDU; or
- control plane data; and
- a MAC-I field for SRBs only;

6.1.2 PDCP Control PDU

The PDCP Control PDU is used to convey:

- a PDCP status report indicating which PDCP SDUs are missing and which are not following a handover.
- header compression control information, e.g. interspersed ROHC feedback.

6.2 Formats

6.2.1 General

A PDCP PDU is a bit string that is byte aligned (i.e. multiple of 8 bits) in length. In the figures in sub clause 6.2, bit strings are represented by tables in which the most significant bit is the leftmost bit of the first line of the table, the least significant bit is the rightmost bit on the last line of the table, and more generally the bit string is to be read from left to right and then in the reading order of the lines. The bit order of each parameter field within a PDCP PDU is represented with the first and most significant bit in the leftmost bit and the last and least significant bit in the rightmost bit.

PDCP SDUs are bit strings that are byte aligned (i.e. multiple of 8 bits) in length. A compressed or uncompressed SDU is included into a PDCP PDU from the first bit onward.

6.2.2 Control plane PDCP Data PDU SRBs

Figure 6.2.2.1 shows the format of the PDCP Data PDU carrying data for control plane SRBs.

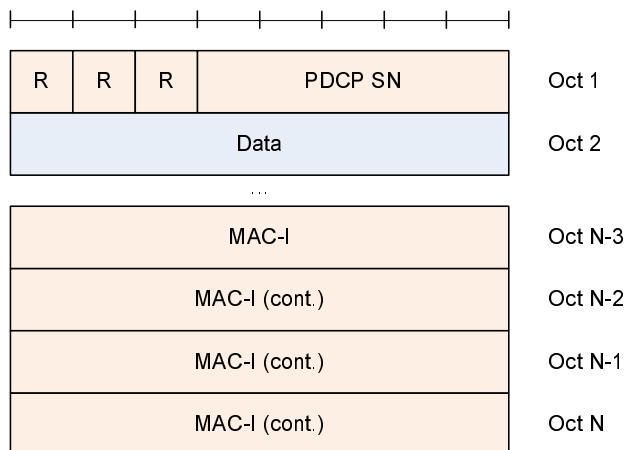

Figure 6.2.2.1: PDCP Data PDU format for SRBs

6.2.3 User plane PDCP Data PDU with long PDCP SN (12 bits)

Figure 6.2.3.1 shows the format of the PDCP Data PDU when a 12 bit SN length is used. This format is applicable for PDCP Data PDUs carrying data from DRBs mapped on RLC AM or RLC UM.

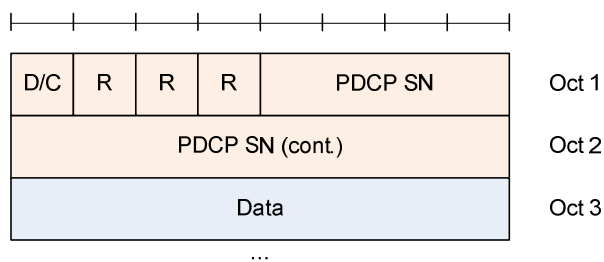

Figure 6.2.3.1: PDCP Data PDU format for DRBs using a 12 bit SN

6.2.4 User plane PDCP Data PDU with short PDCP SN (7 bits)

Figure 6.2.4.1 shows the format of the PDCP Data PDU when a 7 bit SN length is used. This format is applicable for PDCP Data PDUs carrying data from DRBs mapped on RLC UM.

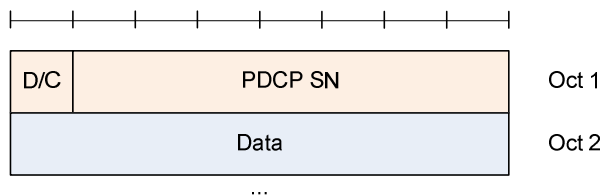

Figure 6.2.4.1: PDCP Data PDU format for DRBs using 7 bit SN

6.2.5 PDCP Control PDU for interspersed ROHC feedback packet

Figure 6.2.5.1 shows the format of the PDCP Control PDU carrying one interspersed ROHC feedback packet.

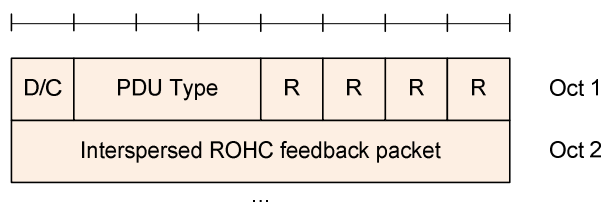

Figure 6.2.5.1: PDCP Data PDU format for interspersed ROHC feedback packet

6.2.6 PDCP Control PDU for PDCP status report

Figure 6.2.6.1 shows the format of the PDCP Control PDU carrying data from the user plane for PDCP status report with a 12 bits SN.

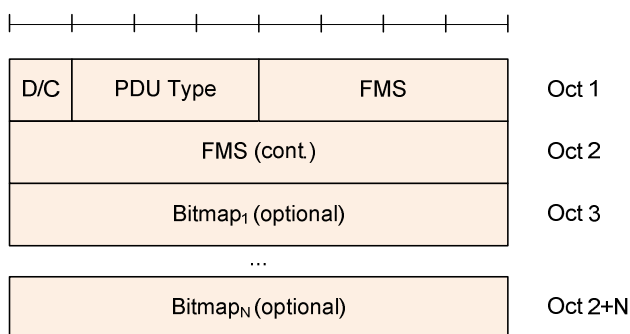

Figure 6.2.6.1: PDCP Data PDU format for PDCP status report

6.2.7 PDCP Data PDU for u-plane data over MBSFN (FFS)

NOTE: MBSFN is not supported in this version of the specification.

6.3 Parameters

6.3.1 General

If not otherwise mentioned in the definition of each field then the bits in the parameters shall be interpreted as follows: the left most bit string is the first and most significant and the right most bit is the last and least significant bit.

Unless otherwise mentioned, integers are encoded in standard binary encoding for unsigned integers. In all cases the bits appear ordered from MSB to LSB when read in the PDU.

6.3.2 PDCP SN

Length: 5, 7 or 12 bits as indicated in table 6.3.2.1.

Table 6.3.2.1: PDCP SN length

Length	Description
5	SRBs
7	DRBs, if configured by upper layers
12	DRBs, if configured by upper layers

6.3.3 Data

Length: Variable

The Data field may include either one of the following:

- Uncompressed PDCP SDU (user plane data, or control plane data); or
- Compressed PDCP SDU (user plane data only).

6.3.4 MAC-I

Length: 32 bits

The MAC-I field carries a message authentication code calculated as specified in subclause 5.4.

For control plane data that are not integrity protected, the MAC-I field is still present and should be padded with padding bits set to 0.

6.3.5 COUNT

Length: 32 bits

For ciphering and integrity a COUNT value is maintained. The COUNT value is composed of a HFN and the PDCP SN. The length of the PDCP SN is configured by upper layers.



Figure 6.3.5.1: Format of COUNT

The size of the HFN part in bits is equal to 32 minus the length of the PDCP SN.

6.3.6 R

Length: 1 bit

Reserved. In this version of the specification reserved bits shall be set to 0. Reserved bits shall be ignored by the receiver.

6.3.7 D/C

Length: 1 bit

Table 6.3.7.1: D/C field

Bit	Description
0	Control PDU
1	Data PDU

6.3.8 PDU type

Length: 3 bits

Table 6.3.8.1: PDU type

Bit	Description
000	PDCP status report
001	Header Compression Feedback Information
010-111	reserved

6.3.9 FMS

Length: 12 bits

PDCP SN of the first missing PDCP SDU.

6.3.10 Bitmap

Length: Variable

The length of the bitmap field can be 0.

The MSB of the first octet of the type "Bitmap" indicates whether or not the PDCP SDU with the SN (FMS + 1) modulo 4096 has been received and, optionally decompressed correctly. The LSB of the first octet of the type "Bitmap" indicates whether or not the PDCP SDU with the SN (FMS + 8) modulo 4096 has been received correctly.

Table 6.3.10.1 Bitmap

Bit	Description
0	PDCP SDU with PDCP SN = (FMS + bit position) modulo 4096 is missing in the receiver. The bit position of N th bit in the Bitmap is N, i.e., the bit position of the first bit in the Bitmap is 1.
1	PDCP PSU with PDCP SN = (FMS + bit position) modulo 4096 does not need to be retransmitted. The bit position of N th bit in the Bitmap is N, i.e., the bit position of the first bit in the Bitmap is 1.

The UE fills the bitmap indicating which SDUs are missing (unset bit - "0"), i.e. whether an SDU has not been received or optionally has been received but has not been decompressed correctly, and which SDUs do not need retransmission (set bit - "1"), i.e. whether an SDU has been received correctly and may or may not have been decompressed correctly.

6.3.11 Interspersed ROHC feedback packet

Length: Variable

Contains one ROHC packet with only feedback, i.e. a ROHC packet that is not associated with a PDCP SDU as defined in subclause 5.2.4.

7 Variables, constants and timers

7.1 State variables

This sub clause describes the state variables used in PDCP entities in order to specify the PDCP protocol.

All state variables are non-negative integers.

The transmitting side of each PDCP entity shall maintain the following state variables:

a) Next_PDCP_TX_SN

The variable Next_PDCP_TX_SN indicates the PDCP SN of the next PDCP SDU for a given PDCP entity. At establishment of the PDCP entity, Next_PDCP_TX_SN is set to 0.

b) TX_HFN

The variable TX_HFN indicates the HFN value for the generation of the COUNT value used for PDCP PDUs for a given PDCP entity. At establishment of the PDCP entity, TX_HFN is set to 0.

The receiving side of each PDCP entity shall maintain the following state variables:

c) Next_PDCP_RX_SN

The variable Next_PDCP_RX_SN indicates the next expected PDCP SN by the receiver for a given PDCP entity. At establishment of the PDCP entity, Next_PDCP_RX_SN is set to 0.

d) RX_HFN

The variable RX_HFN indicates the HFN value for the generation of the COUNT value used for the received PDCP PDUs for a given PDCP entity. At establishment of the PDCP entity, RX_HFN is set to 0.

e) Last_Submitted_PDCP_RX_SN

For PDCP entities mapped on RLC AM the variable Last_Submitted_PDCP_RX_SN indicates the SN of the last PDCP SDU delivered to the upper layers. At establishment of the PDCP entity, Last_Submitted_PDCP_RX_SN is set to 4095.

7.2 Timers

The transmitting side of each PDCP entity for DRBs shall maintain the following timers:

a) Discard_Timer

The value of the timer is signalled by upper layers. In the transmitter, a new timer is started upon reception of an SDU from upper layer.

The receiving side of each PDCP entity, for DRBs that are mapped on RLC AM, shall maintain the following timers:

b) Flush_Timer

The value of the timer is signalled by upper layers. The timer is started when upper layers indicate that a handover has occurred.

7.3 Constants

a) Reordering_Window

Indicates the size of the reordering window. The size equals to 2048, i.e. half of the PDCP SN space, for radio bearers that are mapped on RLC AM.

b) Maximum_PDCP_SN is:

- 4095 if the PDCP entity is configured for the use of 12 bit SNs
- 127 if the PDCP entity is configured for the use of 7 bit SNs
- 31 if the PDCP entity is configured for the use of 5 bit SNs

Annex A (informative): Change history

Change history after change control							
Date	TSG #	TSG Doc.	CR	Rev	Subject/Comment	Old	New
12/2007	RP-38	RP-070919	-	-	Approved at TSG-RAN #38 and placed under Change Control	2.0.0	8.0.0
03/2008	RP-39	RP-080197	0001	-	CR to 36.323 with Update of E-UTRAN PDCP specification	8.0.0	8.1.0
Date	TSG #	TSG Doc.	CR	Rev	Subject/Comment	Old	New
05/2008	RP-40	RP-080412	0002	-	Clarification of the BSR calculation	8.1.0	8.2.0
	RP-40	RP-080412	0003	1	PDCP minor changes	8.1.0	8.2.0
	RP-40	RP-080387	0004	3	Addition of a duplicate discard window	8.1.0	8.2.0
	RP-40	RP-080412	0006	-	Reference to ROHCv2 profiles	8.1.0	8.2.0
	RP-40	RP-080412	0010	-	Bitmap in the DL PDCP status report	8.1.0	8.2.0
05/2008	-	-	-	-	Corrections to sections 5.5.1.1, 5.5.1.2.1 and 5.8 to correctly implement CR0004 Rev 3 (instead of CR0004 Rev 2 of RP-080412).	8.2.0	8.2.1
09/2008	RP-41	RP-080692	0013	-	Restructuring of PDCP specification	8.2.1	8.3.0
	RP-41	RP-080692	0016	-	Miscellaneous PDCP corrections	8.2.1	8.3.0
	RP-41	RP-080692	0023	-	Correction to the PDCP structure	8.2.1	8.3.0
	RP-41	RP-080692	0033	-	Initial TX_HFN and RX_HFN values	8.2.1	8.3.0

History

Document history		
V8.2.1	November 2008	Publication
V8.3.0	November 2008	Publication