

ETSI TS 143 064 V6.10.0 (2006-01)

Technical Specification

**Digital cellular telecommunications system (Phase 2+);
General Packet Radio Service (GPRS);
Overall description of the GPRS radio interface;
Stage 2
(3GPP TS 43.064 version 6.10.0 Release 6)**



Reference

RTS/TSGG-0143064v6a0

Keywords

GSM

ETSI

650 Route des Lucioles
F-06921 Sophia Antipolis Cedex - FRANCE

Tel.: +33 4 92 94 42 00 Fax: +33 4 93 65 47 16

Siret N° 348 623 562 00017 - NAF 742 C
Association à but non lucratif enregistrée à la
Sous-Préfecture de Grasse (06) N° 7803/88

Important notice

Individual copies of the present document can be downloaded from:

<http://www.etsi.org>

The present document may be made available in more than one electronic version or in print. In any case of existing or perceived difference in contents between such versions, the reference version is the Portable Document Format (PDF). In case of dispute, the reference shall be the printing on ETSI printers of the PDF version kept on a specific network drive within ETSI Secretariat.

Users of the present document should be aware that the document may be subject to revision or change of status. Information on the current status of this and other ETSI documents is available at

<http://portal.etsi.org/tb/status/status.asp>

If you find errors in the present document, please send your comment to one of the following services:

http://portal.etsi.org/chaicor/ETSI_support.asp

Copyright Notification

No part may be reproduced except as authorized by written permission.
The copyright and the foregoing restriction extend to reproduction in all media.

© European Telecommunications Standards Institute 2006.
All rights reserved.

DECTTM, **PLUGTESTS**TM and **UMTS**TM are Trade Marks of ETSI registered for the benefit of its Members.
TIPHONTM and the **TIPHON logo** are Trade Marks currently being registered by ETSI for the benefit of its Members.
3GPPTM is a Trade Mark of ETSI registered for the benefit of its Members and of the 3GPP Organizational Partners.

Intellectual Property Rights

IPRs essential or potentially essential to the present document may have been declared to ETSI. The information pertaining to these essential IPRs, if any, is publicly available for **ETSI members and non-members**, and can be found in ETSI SR 000 314: "*Intellectual Property Rights (IPRs); Essential, or potentially Essential, IPRs notified to ETSI in respect of ETSI standards*", which is available from the ETSI Secretariat. Latest updates are available on the ETSI Web server (<http://webapp.etsi.org/IPR/home.asp>).

Pursuant to the ETSI IPR Policy, no investigation, including IPR searches, has been carried out by ETSI. No guarantee can be given as to the existence of other IPRs not referenced in ETSI SR 000 314 (or the updates on the ETSI Web server) which are, or may be, or may become, essential to the present document.

Foreword

This Technical Specification (TS) has been produced by ETSI 3rd Generation Partnership Project (3GPP).

The present document may refer to technical specifications or reports using their 3GPP identities, UMTS identities or GSM identities. These should be interpreted as being references to the corresponding ETSI deliverables.

The cross reference between GSM, UMTS, 3GPP and ETSI identities can be found under <http://webapp.etsi.org/key/queryform.asp>.

Contents

Intellectual Property Rights	2
Foreword.....	2
Foreword.....	6
1 Scope	7
2 References	8
3 Abbreviations, symbols and definitions	8
3.1 Abbreviations	8
3.2 Symbols.....	9
3.3 Definitions	9
3.3.1 General.....	9
3.3.2 EGPRS mobile station	10
3.3.3 Dual Transfer Mode.....	10
4 Packet data logical channels	10
4.1 General	10
4.2 Packet Common Control Channel (PCCCH) and Compact (CPCCCH)	10
4.2.1 Packet Random Access Channel (PRACH) and Compact Packet Random Access Channel (CPRACH) - uplink only	10
4.2.2 Packet Paging Channel (PPCH) and Compact Packet Paging Channel (CPPCH) - downlink only	10
4.2.3 Packet Access Grant Channel (PAGCH) and Compact Packet Access Grant Channel (CPAGCH) - downlink only	10
4.3 Packet Broadcast Control Channel (PBCCH) and Compact Packet Broadcast Control Channel (CPBCCH) - downlink only	11
4.4 Packet Traffic Channels	11
4.4.1 Packet Data Traffic Channel (PDTCH)	11
4.5 Packet Dedicated Control Channels	11
4.5.1 Packet Associated Control Channel (PACCH)	11
4.5.2 Packet Timing advance Control Channel, uplink (PTCCH/U)	11
4.5.3 Packet Timing advance Control Channel, downlink (PTCCH/D)	11
4.6 MBMS Common Control Channels	11
4.6.1 MBMS Packet Random Access Channel (MPRACH) - uplink only	11
5 Mapping of packet data logical channels onto physical channels	12
5.1 General	12
5.2 Packet Common Control Channels (PCCCH and CPCCCH)	12
5.2.1 Packet Random Access Channel (PRACH and CPRACH)	12
5.2.2 Packet Paging Channel (PPCH and CPPCH)	13
5.2.3 Packet Access Grant Channel (PAGCH and CPAGCH)	13
5.2.4 Packet Notification Channel (PNCH and CPNCH)	13
5.2a MBMS Common Control Channels (MPRACH).....	13
5.3 Packet Broadcast Control Channel (PBCCH and CPBCCH)	13
5.3a Compact Frequency Correction Channel (CFCCCH).....	13
5.3b Compact Synchronization Channel (CSCH)	14
5.4 Packet Timing advance Control Channel (PTCCH).....	14
5.5 Packet Traffic Channels	14
5.5.1 Packet Data Traffic Channel (PDTCH)	14
5.5.2 Packet Associated Control Channel (PACCH)	14
5.6 Downlink resource sharing	14
5.7 Uplink resource sharing.....	15
6 Radio Interface (Um).....	15
6.1 Radio Resource management principles.....	15
6.1.1 Allocation of resources for the GPRS	15
6.1.1.1 Master-Slave concept	15
6.1.1.2 Capacity on demand concept.....	16

6.1.1.3	Procedures to support capacity on demand	16
6.1.1.4	Release of PDCH not carrying PCCCH	16
6.1.2	Multiframe structure for PDCH	17
6.1.2a	Multiframe structure for Compact PDCH	17
6.1.2b	Multiframe structure for PDCH/H	18
6.1.3	Scheduling of PBCCH information	19
6.1.4	SMS cell broadcast	19
6.2	Radio Resource operating modes	19
6.2.1	Packet idle mode	19
6.2.2	Packet transfer mode	19
6.2.3	Dual transfer mode	20
6.2.3a	Broadcast/Multicast receive mode	20
6.2.4	Correspondence between Radio Resource operating modes and Mobility Management States	20
6.2.5	Transitions between RR operating modes	21
6.3	Layered overview of radio interface	22
6.4	Physical RF Layer	23
6.5	Physical Link Layer	23
6.5.1	Layer Services	23
6.5.2	Layer Functions	23
6.5.3	Service Primitives	24
6.5.4	Radio Block Structure	24
6.5.5	Channel Coding	25
6.5.5.1	Channel coding for PDTCH	25
6.5.5.1.1	Channel coding for GPRS PDTCH	25
6.5.5.1.2	Channel coding for EGPRS PDTCH	27
6.5.5.2	Channel coding for PACCH, PBCCH, PAGCH, PPCH, PNCH and PTCCH	34
6.5.5.2a	Channel coding for CPBCCH, CPAGCH, CPPCH, CPNCH, and CSCH	34
6.5.5.3	Channel Coding for the PRACH, CPRACH and MPRACH	34
6.5.5.3.1	Coding of the 8 data bit Packet Access Burst	34
6.5.5.3.2	Coding of the 11 data bit Packet Access Burst	34
6.5.6	Cell Re-selection	35
6.5.6.1	Measurements for Cell Re-selection	35
6.5.6.2	Broadcast Information	35
6.5.6.3	Optional measurement reports and network controlled cell re-selection	35
6.5.6.4	Network Assisted Cell Change	36
6.5.7	Timing Advance	36
6.5.7.1	Initial timing advance estimation	37
6.5.7.2	Continuous timing advance update	37
6.5.7.2.1	Mapping on the multiframe structure	37
6.5.8	Power control procedure	39
6.5.8.1	MS output power	39
6.5.8.2	BTS output power	40
6.5.8.3	Measurements at MS side	40
6.5.8.3.1	Deriving the C value	40
6.5.8.3.2	Derivation of Channel Quality Report	40
6.5.8.4	Measurements at BSS side	41
6.5.9	Scheduling the MS activities during the PTCCH and idle frames	41
6.5.10	Discontinuous Reception (DRX)	41
6.6	Medium Access Control and Radio Link Control Layer	42
6.6.1	Layer Services	42
6.6.2	Layer Functions	42
6.6.3	Service Primitives	43
6.6.4	Model of Operation	43
6.6.4.1	Multiplexing MSs on the same PDCH	45
6.6.4.1.1	Uplink State Flag: Dynamic Allocation	45
6.6.4.1.1.1	Multiplexing of GPRS or EGPRS MSs	45
6.6.4.1.1.2	Multiplexing of GPRS and EGPRS MSs	46
6.6.4.1.2	Void	46
6.6.4.1.3	Exclusive Allocation	46
6.6.4.2	Temporary Block Flow	46
6.6.4.3	Temporary Flow Identity	46
6.6.4.4	Medium Access modes	46

6.6.4.5	Acknowledged mode for RLC/MAC operation	47
6.6.4.5.1	GPRS	47
6.6.4.5.2	EGPRS	47
6.6.4.6	Unacknowledged mode for RLC/MAC operation	47
6.6.4.6a	Non-persistent mode for RLC/MAC operation	48
6.6.4.7	Mobile Originated Packet Transfer	48
6.6.4.7.1	Uplink Access	48
6.6.4.7.1.1	On the (P)RACH	48
6.6.4.7.1.2	On the main DCCH	50
6.6.4.7.2	Dynamic/Extended Dynamic allocation	51
6.6.4.7.2.1	Uplink Packet Transfer	51
6.6.4.7.2.2	Release of the Resources	52
6.6.4.7.3	Void	53
6.6.4.7.4	Exclusive Allocation	53
6.6.4.7.5	Contention Resolution	53
6.6.4.8	Mobile Terminated Packet Transfer	54
6.6.4.8.1	Packet Paging	54
6.6.4.8.2	Downlink Packet Transfer	54
6.6.4.8.3	Release of the Resources	56
6.6.4.8.4	Packet Paging Notification	56
6.6.4.9	Simultaneous Uplink and Downlink Packet Transfer	57
6.6.4.9.1	MS Does Not Support Multiple TBF Procedures	57
6.6.4.9.2	MS Supports Multiple TBF Procedures	57
6.7	Abnormal cases in GPRS MS Ready State	58
6.8	Void	58
6.9	MBMS Data Transfer	58
Annex A (informative): Bibliography		59
Annex B (informative): Multiple TBF Feature		60
B.1	General	60
B.2	Multiple TBF capability	60
B.3	Multiple TBF procedures	61
B.3.1	Data multiplexing options	61
B.3.1.1	Single TBF per upper layer flow	61
B.3.1.2	DL TBF sharing	61
B.3.1.3	Explicit UL TBF switching	61
B.3.2	RLC/MAC Signalling	61
B.3.3	TBF establishment	61
B.3.3.1	TFI allocation	61
B.3.3.2	Single TBF request / establishment	62
B.3.3.3	Multiple TBF establishment / reconfiguration	62
B.3.3.3.1	Multiple uplink TBF request / establishment	62
B.3.3.3.2	Multiple downlink TBF establishment	63
B.3.3.3.3	Usage of multiple TBF assignment messages	63
B.4	RLC/MAC Timers	64
B.4.1	TBF timers	64
B.4.2	Contention resolution timer	64
B.5	CSN.1 coding of multiple TBF messages	64
B.5.1	MULTIPLE TBF UPLINK ASSIGNMENT message	64
B.5.2	MULTIPLE TBF DOWNLINK ASSIGNMENT message	65
B.5.3	MULTIPLE TBF TIMESLOT RECONFIGURE message	66
Annex C (informative): Change history		67
History		69

Foreword

This Technical Specification has been produced by the 3rd Generation Partnership Project (3GPP).

The contents of the present document are subject to continuing work within the TSG and may change following formal TSG approval. Should the TSG modify the contents of the present document, it will be re-released by the TSG with an identifying change of release date and an increase in version number as follows:

Version x.y.z

where:

- x the first digit:
 - 1 presented to TSG for information;
 - 2 presented to TSG for approval;
 - 3 or greater indicates TSG approved document under change control.
- y the second digit is incremented for all changes of substance, i.e. technical enhancements, corrections, updates, etc.
- z the third digit is incremented when editorial only changes have been incorporated in the document.

1 Scope

The present document provides the overall description for lower-layer functions of the General Packet Radio Service (GPRS and EGPRS) radio interface (Um). Within this TS the term GPRS refers to GPRS and EGPRS unless explicitly stated otherwise.

The overall description provides the following information:

- The services offered to higher-layer functions,
- The distribution of required functions into functional groups,
- A definition of the capabilities of each functional group,
- Service primitives for each functional group, including a description of what services and information flows are to be provided, and
- A model of operation for information flows within and between the functions.

The present document is applicable to the following GPRS Um functional layers:

- Radio Link Control functions,
- Medium Access Control functions, and
- Physical Link Control functions.

The present document describes the information transfer and control functions to be used across the radio (Um) interface for communication between the MS and the Network, see Figure 1.

3GPP TS 23.060 [3] describes the overall GPRS logical architecture and the GPRS functional layers above the Radio Link Control and Medium Access Control layer.

3GPP TS 24.007 [5] contains a description in general terms of the structured functions and procedures of this protocol and the relationship of this protocol with other layers and entities.

3GPP TS 44.018 [6] contains the definition of GPRS RLC/MAC procedures when operating on the Common Control Channel (CCCH).

3GPP TS 44.060 [7] contains the definition of RLC/MAC functions when operating on a Packet Data Channel (PDCH).

3GPP TS 44.064 [8] contains functional procedures for the Logical Link Control (LLC) layer above the RLC/MAC.

3GPP TS 45 series defines the Physical Link layer and Physical RF layer.

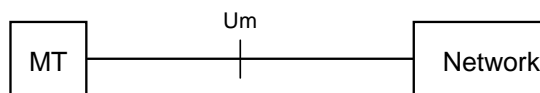

Figure 1: Scope of GPRS Logical Radio Interface Architecture

2 References

The following documents contain provisions which, through reference in this text, constitute provisions of the present document.

- References are either specific (identified by date of publication, edition number, version number, etc.) or non-specific.
- For a specific reference, subsequent revisions do not apply.
- For a non-specific reference, the latest version applies. In the case of a reference to a 3GPP document (including a GSM document), a non-specific reference implicitly refers to the latest version of that document *in the same Release as the present document*.

- [1] 3GPP TR 21.905: "Vocabulary for 3GPP Specifications".
- [2] 3GPP TS 22.060: "General Packet Radio Service (GPRS); Stage 2".
- [3] 3GPP TS 23.060: "General Packet Radio Service (GPRS); Service description; Stage 2".
- [4] 3GPP TS 44.004: "Digital cellular telecommunications system; Layer 1; General requirements".
- [5] 3GPP TS 24.007: "Mobile radio interface signalling layer 3 General aspects"
- [6] 3GPP TS 44.018: "Mobile radio interface layer 3 specification; Radio Resource Control Protocol"
- [7] 3GPP TS 44.060: "Radio Link Control/Medium Access Control (RLC/MAC) protocol".
- [8] 3GPP TS 44.064: "General Packet Radio Service (GPRS); Logical Link Control (LLC)".
- [9] 3GPP TS 44.065: "General Packet Radio Service (GPRS); Subnetwork Dependent Convergence Protocol (SNDCCP)".
- [10] 3GPP TS 45.001: "Physical layer on the radio path, General description".
- [11] 3GPP TS 45.002: "Multiplexing and multiple access on the radio path".
- [12] 3GPP TS 45.003: "Channel coding".
- [13] 3GPP TS 45.004: "Modulation".
- [14] 3GPP TS 45.005: "Radio transmission and reception".
- [15] 3GPP TS 45.008: "Radio subsystem link control".
- [16] 3GPP TS 45.010: "Radio subsystem synchronisation".
- [17] 3GPP TS 43.246: "Multimedia Broadcast Multicast Service (MBMS) in the GERAN; Stage 2".

3 Abbreviations, symbols and definitions

3.1 Abbreviations

In addition to abbreviations in 3GPP TR 21.905 [1] and 3GPP TS 22.060 [2] the following abbreviations apply:

ARQ	Automatic Repeat reQuest
BCS	Block Check Sequence
BEC	Backward Error Correction
BH	Block Header
CCN	Cell Change Notification
CFCH	Compact Frequency Correction Channel
CPAGCH	Compact Packet Access Grant Channel

CPBCCCH	Compact Packet Broadcast Control Channel
CPCCCH	Compact Packet Common Control Channel
CPPCH	Compact Packet Paging Channel
CPRACH	Compact Packet Random Access Channel
CSCH	Compact Synchronization Channel
CS	Coding Scheme
CU	Cell Update
DTM	Dual Transfer Mode
EGPRS	Enhanced GPRS
FBI	Final Block Indicator
FH	Frame Header
GGSN	Gateway GPRS Support Node
HCS	Header Check Sequence
IR	Incremental Redundancy
LLC	Logical Link Control
MAC	Medium Access Control
MBMS	Multimedia Broadcast/Multicast Service
MCS	Modulation and Coding Scheme
MPRACH	MBMS Packet Random Access Channel
NSS	Network and Switching Subsystem
PACCH	Packet Associate Control Channel
PAGCH	Packet Access Grant Channel
PBCCH	Packet Broadcast Control Channel
PC	Power Control
PCCCH	Packet Common Control Channel
PDCH	Packet Data Channel
PDTCH	Packet Data Traffic Channel
PDU	Protocol Data Unit
PFC	Packet Flow Context
PFI	Packet Flow Identifier
PL	Physical Link
PPCH	Packet Paging Channel
PRACH	Packet Random Access Channel
PSI	Packet System Information
PTCCH	Packet Timing Advance Control Channel
p-t-m	point-to-multipoint
RLC	Radio Link Control
SGSN	Serving GPRS Support Node
SNDC	Subnetwork Dependent Convergence
TA	Timing Advance
TBF	Temporary Block Flow
TFI	Temporary Frame Identity
USF	Uplink State Flag

3.2 Symbols

For the purposes of the present document, the following symbols apply:

Gb	Interface between an SGSN and a BSC.
Um	Interface between MS and GPRS fixed network part. The Um interface is the GPRS network interface for providing packet data services over the radio to the MS.

3.3 Definitions

3.3.1 General

GPRS specific definitions can be found in 3GPP TS 22.060 [2] and 3GPP TS 23.060 [3].

3.3.2 EGPRS mobile station

An EGPRS mobile station is a GPRS mobile station with additional capabilities for new radio access protocol features and new modulation and coding schemes. An EGPRS mobile station shall comply with GPRS requirements and the additional requirements defined for an EGPRS mobile station. The support of EGPRS is optional for the mobile station and the network.

3.3.3 Dual Transfer Mode

In dual transfer mode, the mobile station is allocated resources providing an RR connection and one or more Temporary Block Flows on one or more physical channels. This feature is optional for the mobile station and the network. It is only applicable for a mobile station supporting GPRS or EGPRS. Dual transfer mode is a subset of class A mode of operation, which is only possible if there is radio resource allocation co-ordination in the network.

4 Packet data logical channels

NOTE: The text in this clause is informative. The normative text is in 3GPP TS 45.002 [11]. Where there is a conflict between these descriptions, the normative text has precedence.

4.1 General

This subclause describes the packet data logical channels that are supported by the radio subsystem. The packet data logical channels are mapped onto the physical channels that are dedicated to packet data.

The physical channel dedicated to packet data traffic is called a Packet Data Channel (PDCH).

4.2 Packet Common Control Channel (PCCCH) and Compact (CPCCCH)

PCCCH and CPCCCH comprises logical channels for common control signalling used for packet data as described in the following subclauses.

4.2.1 Packet Random Access Channel (PRACH) and Compact Packet Random Access Channel (CPRACH) - uplink only

PRACH and CPRACH are used by MS to initiate uplink transfer for sending data or signalling information. Packet Access burst and Extended Packet Access burst are used on PRACH. Extended Packet Access burst is used on CPRACH.

4.2.2 Packet Paging Channel (PPCH) and Compact Packet Paging Channel (CPPCH) - downlink only

PPCH and CPPCH are used to page an MS prior to downlink packet transfer. PPCH and CPPCH use paging groups in order to allow usage of DRX mode. PPCH can be used for paging of both circuit switched and packet data services. The paging for circuit switched services on PPCH is applicable for class A and B GPRS MSs in Network operation mode I, see 3GPP TS 23.060 [3].

4.2.3 Packet Access Grant Channel (PAGCH) and Compact Packet Access Grant Channel (CPAGCH) - downlink only

PAGCH and CPAGCH are used in the packet transfer establishment phase to send resource assignment to an MS prior to packet transfer.

4.3 Packet Broadcast Control Channel (PBCCH) and Compact Packet Broadcast Control Channel (CPBCCH) - downlink only

PBCCH and CPBCCH broadcast packet data specific System Information. If PBCCH is not allocated, the packet data specific system information is broadcast on BCCH. For Compact, CPBCCH shall be allocated. CPBCCH and BCCH are mutually exclusive.

4.4 Packet Traffic Channels

4.4.1 Packet Data Traffic Channel (PDTCH)

PDTCH is a channel allocated for data transfer. It is temporarily dedicated to one MS or to a group of MSs in the case of p-t-m transmission. In the multislot operation, one MS or a group of MSs may use multiple PDTCHs in parallel for individual packet transfer.

All packet data traffic channels are uni-directional, either uplink (PDTCH/U), for a mobile originated packet transfer or downlink (PDTCH/D) for a mobile terminated packet transfer.

4.5 Packet Dedicated Control Channels

4.5.1 Packet Associated Control Channel (PACCH)

PACCH conveys signalling information related to a given MS. The signalling information includes e.g. acknowledgements and power control information. PACCH carries also resource assignment and reassignment messages, comprising the assignment of a capacity for PDTCH(s) and for further occurrences of PACCH. The PACCH shares resources with PDTCHs, that are currently assigned to one MS. Additionally, an MS that is currently involved in packet transfer, can be paged for circuit switched services on PACCH.

4.5.2 Packet Timing advance Control Channel, uplink (PTCCH/U)

PTCCH/U is used to transmit random access burst to allow estimation of the timing advance for one MS in packet transfer mode.

PTCCH/U shall not be used for DTM.

4.5.3 Packet Timing advance Control Channel, downlink (PTCCH/D)

PTCCH/D is used to transmit timing advance information updates to several MS. One PTCCH/D is paired with several PTCCH/U's.

PTCCH/D shall be ignored by MS operating in DTM.

4.6 MBMS Common Control Channels

4.6.1 MBMS Packet Random Access Channel (MPRACH) - uplink only

The MPRACH is used by the MS during the initial counting procedure for MBMS (see 3GPP TS 44.060). Packet Access burst and Extended Packet Access burst are used on MPRACH.

5 Mapping of packet data logical channels onto physical channels

NOTE: The text in this clause is informative. The normative text is in 3GPP TS 45.002 [11]. Where there is a conflict between these descriptions, the normative text has precedence.

5.1 General

Different packet data logical channels can occur on the same physical channel (i.e. PDCH). The sharing of the physical channel is based on blocks of 4 consecutive bursts, except for PTCCH. The mapping in frequency of PDCH on to the physical channel shall be as defined in 3GPP TS 45.002 [11].

A PDCH may be either full-rate (PDCH/F) or half-rate (PDCH/H). PDCH/H is only applicable to DTM. See 3GPP TS 45.002 [11].

GPRS and EGPRS employ the same physical layer, except for the PDTCH.

On PRACH, CPRACH, MPRACH and PTCCH/U, access bursts are used. On all other packet data logical channels, radio blocks comprising 4 normal bursts are used. The only exception is some messages on uplink PACCH which comprise 4 consecutive access bursts (to increase robustness).

5.2 Packet Common Control Channels (PCCCH and CPCCCH)

At a given time, the logical channels of the PCCCH are mapped on different physical resources than the logical channels of the CCCH.

The PCCCH and CPCCCH do not have to be allocated permanently in the cell. Whenever the PCCCH is not allocated, the CCCH shall be used to initiate a packet transfer. For Compact, CPCCCH shall be allocated.

One given MS may use only a subset of the PCCCH and CPCCCH, the subset being mapped onto one physical channel (i.e. PDCH).

The PCCCH, when it exists:

- is mapped on one or several physical channels according to a 52-multiframe, In that case the PCCCH, PBCCH and PDTCH share same physical channels (PDCHs).

The existence and location of the PCCCH shall be broadcast on the cell.

Since GSM phase 1 and phase 2 MS can only see and use the CCCH, the use on the PCCCH can be optimised for GPRS e.g. a PRACH of 11 bits can be used on uplink.

For Compact, one radio frequency channel of the cell allocation shall be used to carry synchronization information and the CPBCCH, this shall be known as the primary Compact carrier. All other radio frequency channels of the cell allocation shall be known as secondary Compact carriers.

For primary and secondary Compact carriers, CPCCCHs shall be allocated on only one timeslot (which is associated with a time group as defined in 3GPP TS 45.002 [11]). This time group is known as the serving time group and rotates over odd timeslot numbers as follows: 7, 5, 3, 1, 7, 5, The CPCCCH is mapped according to a Compact 52-multiframe and the serving time group rotation occurs between frame numbers (FN) mod 52 = 3 and 4.

5.2.1 Packet Random Access Channel (PRACH and CPRACH)

The PRACH and CPRACH are mapped on one or several physical channels. The physical channels on which the PRACH is mapped are derived by the MS from information broadcast on the PBCCH or BCCH. The physical channels on which the CPRACH is mapped are derived by the MS from information broadcast on the CPBCCH.

PRACH and CPRACH are determined by the Uplink State Flag marked as free that is broadcast continuously on the corresponding downlink (see subclause 6.6.4.1). Additionally, a predefined fixed part of the multiframe structure for PDCH can be used as PRACH or CPRACH only and the information about the mapping on the physical channel is

broadcast on PBCCH or CPBCCH. During those time periods an MS does not have to monitor the USF that is simultaneously broadcast on the downlink.

5.2.2 Packet Paging Channel (PPCH and CPPCH)

The PPCH and CPPCH are mapped on one or several physical channels. The exact mapping on each physical channel follows a predefined rule (see subclause 6.1.2), as it is done for the PCH.

The physical channels on which the PPCH or CPPCH are mapped, as well as the rule that is followed on the physical channels, are derived by the MS from information broadcast on the PBCCH or CPBCCH.

5.2.3 Packet Access Grant Channel (PAGCH and CPAGCH)

The PAGCH and CPAGCH are mapped on one or several physical channels. The exact mapping on each physical channel follows a predefined rule (see subclause 6.1.2).

The physical channels on which the PAGCH or CPAGCH are mapped, as well as the rule that is followed on the physical channels, are derived by the MS from information broadcast on the PBCCH or CPBCCH.

5.2.4 Packet Notification Channel (PNCH and CPNCH)

The PNCH and CPNCH are mapped on one or several blocks on PCCCH and CPCCCH. The exact mapping follows a predefined rule. The mapping is derived by the MS from information broadcast on the PBCCH or CPBCCH.

5.2a MBMS Common Control Channels (MPRACH)

The MPRACH is mapped on one physical channel. The physical channel on which the MPRACH is mapped is indicated to the MS by the network.

The network indicates the value of the USF associated with the MPRACH on a particular PDCH in the notification message. The MPRACH is determined by the Uplink State Flag, which is broadcast on the corresponding downlink (see subclause 6.6.4.1), marked as the value indicated by the network.

5.3 Packet Broadcast Control Channel (PBCCH and CPBCCH)

The PBCCH and CPBCCH shall be mapped on one or several physical channels. The exact mapping on each physical channel follows a predefined rule (see subclause 6.1.2), as it is done for the BCCH. For Compact, CPBCCH shall be allocated. CPBCCH and BCCH are mutually exclusive.

The existence of the PCCCH, and consequently the existence of the PBCCH, is indicated on the BCCH.

For Compact, one radio frequency channel of the cell allocation shall be used to carry synchronization information and the CPBCCH, this shall be known as the primary Compact carrier. All other radio frequency channels of the cell allocation shall be known as secondary Compact carriers.

The CPBCCH shall be mapped on only one timeslot (which is associated with a time group as defined in 3GPP TS 45.002 [11]). This time group is known as the serving time group and rotates over odd timeslot numbers as follows: 7, 5, 3, 1, 7, 5, The CPBCCH is mapped according to a Compact 52-multiframe and the serving time group rotation occurs between frame numbers (FN) mod 52 = 3 and 4. The exact mapping follows a predefined rule (see subclause 6.1.2).

5.3a Compact Frequency Correction Channel (CFCCH)

The CFCCH is the same as the FCCH with one exception — the FCCH is mapped onto a 51-multiframe as defined in 3GPP TS 45.002 [11].

5.3b Compact Synchronization Channel (CSCH)

The CSCH is similar to the SCH. The major difference is that the SCH is mapped onto a 51-multiframe as defined in 3GPP TS 45.002 [11]. This results in a different layout for the reduced TDMA frame number (RFN).

5.4 Packet Timing advance Control Channel (PTCCH)

Two defined frames of multiframe are used to carry PTCCH (see subclause 6.1.2). The exact mapping of PTCCH/U sub-channels and PTCCH/D shall be as defined in 3GPP TS 45.002 [11].

On PTCCH/U, access bursts are used. On PTCCH/D, four normal bursts comprising a radio block are used.

5.5 Packet Traffic Channels

5.5.1 Packet Data Traffic Channel (PDTCH)

One PDTCH is mapped onto one physical channel.

Up to eight PDTCHs, with different timeslots but with the same frequency parameters, may be allocated to one MS at the same time. In the case of p-t-m transmission for MBMS, up to five downlink PDTCH/Fs, with different timeslots but with the same frequency parameters, may be allocated to a group of MSs.

5.5.2 Packet Associated Control Channel (PACCH)

PACCH is dynamically allocated on the block basis on the same physical channel as carrying PDTCHs. However, one block PACCH allocation is used on the physical channel carrying only PCCCH, when the MS is polled to acknowledge the initial assignment message.

PACCH is of a bi-directional nature, i.e. it can dynamically be allocated both on the uplink and on the downlink regardless on whether the corresponding PDTCH assignment is for uplink or downlink.

When PDTCH(s) is assigned on the uplink, the corresponding downlink timeslots have continuously to be monitored by the MS for possible occurrences of PACCH. The MS can use the uplink assignment for sending PACCH blocks whenever needed. In case of extended dynamic allocation (see subclause 6.6.4.4), if the resource assigned by the network does not allow the multislot MS (see 3GPP TS 45.002 [11], annex B) to monitor the USF on all the assigned PDCHs, the PACCH blocks shall be mapped on one PDCH in the list of assigned PDCHs.

When PDTCH(s) is assigned on the downlink, every occurrence of an uplink PACCH block is determined by polling in one of the preceding downlink blocks (transferred on the same PDCH). The network can use the downlink assignment for sending PACCH blocks whenever needed.

During a downlink transmission the network shall not send downlink data to a MS during uplink PACCH timeslots or in a number of timeslot preceding and following the uplink PACCH block. The number of timeslot preceding and following the uplink PACCH timeslots depends upon the multislot class of the half duplex MS.

5.6 Downlink resource sharing

Different packet data logical channels can be multiplexed on the downlink on the same physical channel (i.e. PDCH). See details in 3GPP TS 45.002 [11]. The type of message which is indicated in the radio block header allows differentiation between the logical channels. Additionally, the MS identity allows differentiation between PDTCHs and PACCHs assigned to different MSs. The MS identity also allows differentiation between TBFs and p-t-m MBMS bearers.

In addition, in dual transfer mode the network may allocate a PDCH dedicated to the MS. Even in the case of exclusive allocation, the network shall use the MS identity and the type of message in the radio block header.

5.7 Uplink resource sharing

Different packet data logical channels can be multiplexed on the uplink of the same physical channel (i.e. PDCH). See details in 3GPP TS 45.002 [11]. The type of message which is indicated in the radio block header, allows differentiation between the logical channels. Additionally, the MS identity allows differentiation between PDTCHs and PACCHs assigned to different MSs.

In addition, in dual transfer mode the network may allocate a PDCH dedicated to the MS.

6 Radio Interface (Um)

The logical architecture of the GPRS Um interface can be described using a reference model consisting of functional layers as shown in Figure 3. Layering provides a mechanism for partitioning communications functions into manageable subsets.

Communication between the MS and the Network occurs at the Physical RF, Physical Link, Radio Link Control/Medium Access Control (RLC/MAC), Logical Link Control (LLC) and Subnetwork Dependent Convergence layers.

6.1 Radio Resource management principles

6.1.1 Allocation of resources for the GPRS

A cell supporting GPRS may allocate resources on one or several physical channels in order to support the GPRS traffic. Those physical channels (i.e. PDCHs), shared by the GPRS MSs, are taken from the common pool of physical channels available in the cell. The allocation of physical channels to circuit switched services and GPRS is done dynamically according to the "capacity on demand" principles described below.

Common control signalling required by GPRS in the initial phase of the packet transfer is conveyed on PCCCH, when allocated, or on CCCH. This allows the operator to have capacity allocated specifically to GPRS in the cell only when a packet is to be transferred.

For Compact, common control signaling required by the mobile station in the initial phase of the packet transfer is conveyed on CPCCCH.

6.1.1.1 Master-Slave concept

At least one PDCH, acting as a master, accommodates packet common control channels that carry all the necessary control signalling for initiating packet transfer (i.e. PCCCH), whenever that signalling is not carried by the existing CCCH, as well as user data and dedicated signalling (i.e. PDTCH and PACCH). Other PDCHs, acting as slaves, are used for user data transfer and for dedicated signalling.

For Compact, one radio frequency channel of the cell allocation shall be used to carry synchronization information and the CPBCCCH, this shall be known as the primary Compact carrier. All other radio frequency channels of the cell allocation shall be known as secondary Compact carriers.

For the primary Compact carrier, timeslot numbers (TN) 1, 3, 5, and 7, acting as a master, accommodate packet common control channels that carry all necessary control signalling for initiating packet transfer as well as user data and dedicated signalling (i.e., PDTCH and PACCH). TNs 0, 2, 4, and 6, acting as slaves, are used for user data transfer and for dedicated signalling.

For the secondary Compact carrier(s) carrying CPCCCH, timeslot numbers (TN) 1, 3, 5, and 7, acting as a master, accommodate packet common control channels that carry all necessary control signalling for initiating packet transfer as well as user data and dedicated signalling. TNs 0, 2, 4, and 6, acting as slaves, are used for user data transfer and for dedicated signalling.

For the secondary Compact carrier(s) not carrying CPCCCH, timeslot numbers (TN) 0 through 7, acting as slaves, are used for user data transfer and for dedicated signalling.

6.1.1.2 Capacity on demand concept

The GPRS does not require permanently allocated PDCHs. The allocation of capacity for GPRS can be based on the needs for actual packet transfers which is here referred to as the "capacity on demand" principle. The operator can, as well, decide to dedicate permanently or temporarily some physical resources (i.e. PDCHs) for the GPRS traffic.

When the PDCHs are congested due to the GPRS traffic load and more resources are available in the cell, the Network can allocate more physical channels as PDCHs.

However, the existence of PDCH(s) does not imply the existence of PCCCH.

When no PCCCH is allocated in a cell, all GPRS attached MSs camp on the CCCH.

In response to a Packet Channel Request sent on CCCH from the MS that wants to transmit GPRS packets, the network can assign resources on PDCH(s) for the uplink transfer.. After the transfer, the MS returns to CCCH.

When PCCCH is allocated in a cell, all GPRS attached MSs camp on it. PCCCH can be allocated either as the result of the increased demand for packet data transfers or whenever there is enough available physical channels in a cell (to increase the quality of service). The information about PCCCH is broadcast on BCCH. When the PCCCH capacity is inadequate, it is possible to allocate additional PCCCH resources on one or several PDCHs. If the network releases the last PCCCH, the MS performs cell re-selection.

For Compact, CPBCCCH shall be allocated. CPBCCCH is a stand-alone packet control channel for Compact. CPCCCH shall be allocated. The information about CPCCCH is broadcast on CPBCCCH. When CPCCCH capacity is inadequate, it is possible to allocate additional CPCCCH resources on primary and secondary Compact carriers.

6.1.1.3 Procedures to support capacity on demand

The number of allocated PDCHs in a cell can be increased or decreased according to demand. The following principles can be used for the allocation:

- Load supervision:

A load supervision function may monitor the load of the PDCHs and the number of allocated PDCHs in a cell can be increased or decreased according to demand. Load supervision function may be implemented as a part of the Medium Access Control (MAC) functionality. The common channel allocation function located in BSC is used for the GSM services.

- Dynamic allocation of PDCHs:

Unused channels can be allocated as PDCHs to increase the overall quality of service for GPRS.

Upon resource demand for other services with higher priority, de-allocation of PDCHs can take place.

6.1.1.4 Release of PDCH not carrying PCCCH

The fast release of PDCH is an important feature for possibility to dynamically share the same pool of radio resources for packet and circuit-switched services.

There are following possibilities:

- **Wait for all the assignments to terminate on that PDCH**
- **Individually notify all the users that have assignment on that PDCH**

Packet Uplink Assignment and Packet Downlink Assignment messages can be used for that purpose. The network side has to send such notifications on PACCH(s) individually to each affected MS.

- **Broadcast the notification about de-allocation**

Simple and fast method to broadcast the Packet PDCH Release on all the PDCHs lying on the same carrier as the PDCH to be released. All MSs monitor the possible occurrences of PACCH on one channel and should capture such notification.

In practice, a combination of all the methods can be used.

There may occur the case where an MS remains unaware of the released PDCH. In that case, such MS may cause some interference when wrongly assuming that the decoded Uplink State Flag (see Subclause 6.6.4.1.) denotes the following uplink block period reserved to it. After not getting proper response from the network, the MS would self break the RLC connection.

6.1.2 Multiframe structure for PDCH

NOTE: The text in this clause is informative. The normative text is in 3GPP TS 45.002 [11]. Where there is a conflict between these descriptions, the normative text has precedence.

The mapping in time of the logical channels is defined by a multiframe structure. The multiframe structure for PDCH consists of 52 TDMA frames, divided into 12 blocks (of 4 frames), 2 idle frames and 2 frames used for the PTCCH according to Figure 2.

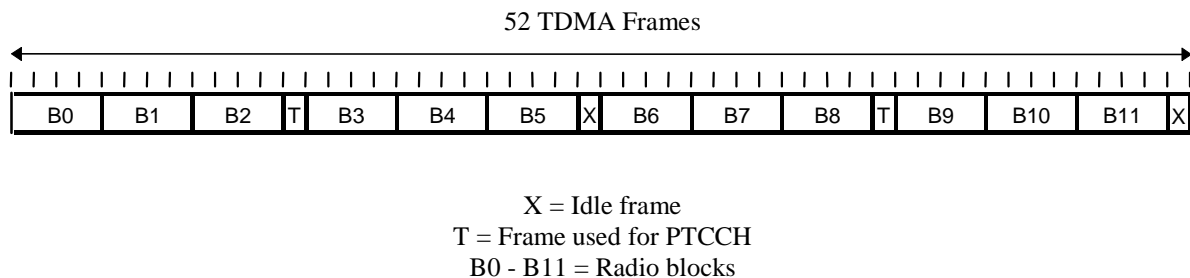

Figure 2: Multiframe structure for PDCH

The mapping of logical channels onto the radio blocks is defined in the rest of this subclause by means of the ordered list of blocks (B0, B6, B3, B9, B1, B7, B4, B10, B2, B8, B5, B11).

One PDCH that contains PCCCH (if any) is indicated on BCCH. That PDCH is the only one that contains PBCCH blocks. On the downlink of this PDCH, the first block (B0) in the ordered list of blocks is used as PBCCH. If required, up to 3 more blocks on the same PDCH can be used as additional PBCCH. Any additional PDCH containing PCCCH is indicated on PBCCH.

On any PDCH with PCCCH (with or without PBCCH), the next up to 12 blocks in the ordered list of blocks are used for PAGCH, PNCH, PDTCH or PACCH in the downlink. The remaining blocks in the ordered list are used for PPCH, PAGCH, PNCH, PDTCH or PACCH in the downlink. In all cases, the actual usage of the blocks is indicated by the message type. On an uplink PDCH that contains PCCCH, all blocks in the multiframe can be used as PRACH, PDTCH or PACCH. Optionally, the first blocks in the ordered list of blocks can only be used as PRACH. The MS may choose to either ignore the USF (consider it as FREE) or use the USF to determine the PRACH in the same way as for the other blocks.

The mapping of channels on multiframes are controlled by several parameters broadcast on PBCCH.

On a PDCH that does not contain PCCCH, all blocks can be used as PDTCH or PACCH. The actual usage is indicated by the message type.

Two frames are used for PTCCH (see 3GPP TS 45.002 [11]) and the two idle frames as well as the PTCCH frames can be used by the MS for signal measurements and BSIC identification.

6.1.2a Multiframe structure for Compact PDCH

NOTE: The text in this clause is informative. The normative text is in 3GPP TS 45.002 [11]. Where there is a conflict between these descriptions, the normative text has precedence.

For Compact, one radio frequency channel of the cell allocation shall be used to carry synchronization information and the CPBCCCH, this shall be known as the primary Compact carrier. All other radio frequency channels of the cell allocation shall be known as secondary Compact carriers.

For the primary Compact carrier, timeslot numbers (TN) 1, 3, 5, and 7 accommodate packet common control channels (i.e., CPBCCCH and CPCCCH) as well as user data and dedicated signalling (i.e., PDTCH and PACCH). TNs 0, 2, 4, and 6 are used for user data transfer and for dedicated signalling.

For the secondary Compact carrier(s) carrying CPCCCH, timeslot numbers (TN) 1, 3, 5, and 7 accommodate packet common control channels as well as user data and dedicated signalling. TNs 0, 2, 4, and 6 are used for user data transfer and for dedicated signalling.

For the secondary Compact carrier(s) not carrying CPCCCH, timeslot numbers (TN) 0 through 7 are used for user data transfer and for dedicated signalling.

For Compact, a base station is typically assigned at least 3 frequencies (one per cell which translates into one primary Compact carrier per cell allocation) using a 1/3 frequency re-use pattern. Each cell is assigned one time group based upon which timeslot number is allocated for control (see 3GPP TS 45.002 [11]). This is known as the serving time group.

Timeslot mapping and rotation of the control channels is used such that control channels belonging to a serving time group are rotated over odd timeslot numbers as follows: 7, 5, 3, 1, 7, 5 The rotation occurs between frame numbers (FN) mod 52 = 3 and 4. Packet switched logical channels PDTCH, PACCH, and PTCCH are never rotated.

For Compact, packet switched logical channels are mapped onto a Compact 52-multiframe. A Compact 52-multiframe consists of 12 blocks of 4 consecutive frames, 2 idle frames (which can be used for CFCCCH and CSCH), and 2 frames used for PTCCH (see 3GPP TS 45.002 [11] and 3GPP TS 45.010 [16]) as shown in Figure 2. A block allocated to a given logical channel comprises one radio block or, in uplink only, 4 random access bursts. The type of channel may vary on a block by block basis.

The mapping of CPBCCCH onto the radio blocks is defined by means of the ordered list of blocks (B0, B6, B3, B9, B1, B7, B4, B10, B2, B8, B5, B11). On the downlink of the primary Compact carrier, the first block (B0) shall be used as CPBCCCH. If required, up to 3 more blocks on the primary Compact carrier can be used as additional CPBCCCH. The next up to 12 blocks in the ordered list of blocks are used for CPAGCH, CPNCH, PDTCH, and PACCH in the downlink. The remaining blocks in the ordered list are used for CPPCH, CPAGCH, and CPNCH in the downlink. In all cases, the actual usage of the blocks is indicated by the message type. The same applies to secondary Compact carriers.

In the uplink of the primary Compact carrier and secondary Compact carrier(s), all blocks in the multiframe can be used as CPRACH. However, a prioritization scheme is recommended (see 3GPP TS 45.002 [11]). The MS may chose to either ignore the USF (consider it as FREE) or use the USF to determine the CPRACH in the same way as for the other blocks. Optionally, the first blocks in the ordered list of blocks can only be used as CPRACH.

The mapping of channels on multiframes are controlled by several parameters broadcast on CPBCCCH.

6.1.2b Multiframe structure for PDCH/H

NOTE: The text in this clause is informative. The normative text is in 3GPP TS 45.002 [11]. Where there is a conflict between these descriptions, the normative text has precedence.

The mapping in time of the logical channels is defined by a multiframe structure. The multiframe structure for PDCH/H consists of 52 TDMA frames, divided into 6 blocks (of 4 frames) and 2 idle frames according to Figure 3. No frames are used for PTCCH (see 3GPP TS 45.002 [11]) and the two idle frames can be used by the MS for signal measurements and BSIC identification.

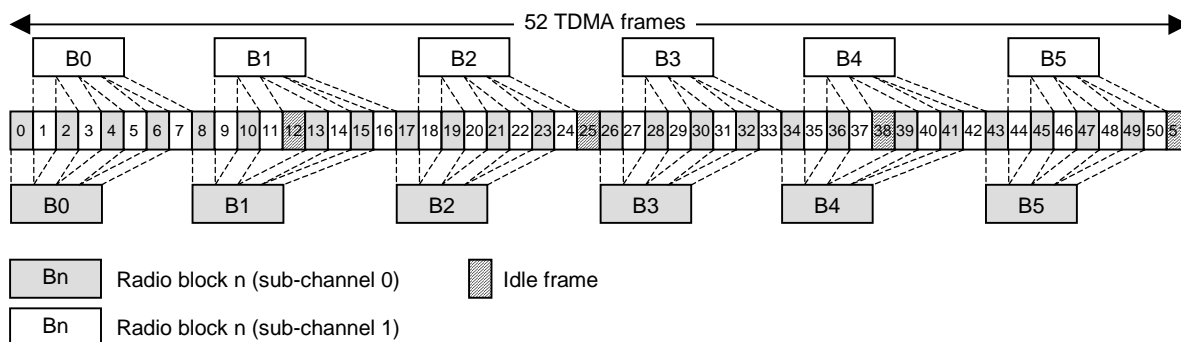

Figure 3: Multiframe structure for PDCH/H

A PDCH/H cannot be used as a PCCCH. On a PDCH/H all blocks can be used as PDTCH or PACCH. The actual usage is indicated by the message type. The PDCH/H shall only be allocated to a mobile station in conjunction with a TCH/H in the other subchannel of the physical channel.

6.1.3 Scheduling of PBCCH information.

An MS attached to GPRS shall not be required to monitor BCCH if a PBCCH exists. All system information relevant for GPRS and some information relevant for circuit switched services (e.g. the access classes) shall in this case be broadcast on PBCCH. For Compact, CPBCCH shall be allocated. CPBCCH and BCCH are mutually exclusive.

In order to facilitate the MS operation, the network is required to transmit certain types of Packet System Information (PSI) messages in specific multiframes and specific PBCCH or CPBCCH blocks within the multiframes. The exact scheduling is in 3GPP TS 45.002 [11].

When no PCCCH is allocated, the MS camps on CCCH and receives all system information on BCCH. Any necessary GPRS specific system information shall in that case be broadcast on BCCH. For Compact, CPCCCH shall be allocated.

6.1.4 SMS cell broadcast

The MS reading of the primary and extended CBCH is occasionally interrupted by MS idle mode procedures when the MS is GPRS attached and in packet idle mode.

6.2 Radio Resource operating modes

Radio Resource (RR) management procedures are characterised by two different RR operating modes. Each mode describes a certain amount of functionality and information allocated. RR procedures and RR operating modes are specified in 3GPP TS 24.007 [5].

6.2.1 Packet idle mode

Packet idle mode is not applicable to an MS supporting DTM that has an ongoing RR connection. An MS that supports DTM, that has an ongoing RR connection and that has no allocated packet resource is in dedicated mode.

In packet idle mode no Temporary Block Flow (see subclause 6.6.4.2) exists. Upper layers can require the transfer of LLC PDUs which, implicitly, may trigger the establishment of one or more TBFs and transition to packet transfer mode.

In packet idle mode, an MS capable of multiple TBF operation may request the establishment of one or more uplink TBFs during a two-phase access.

In packet idle mode, the MS listens to the PBCCH and to the paging sub-channel for the paging group the MS belongs to in idle mode. If PCCCH is not present in the cell, the mobile station listens to the BCCH and to the relevant paging sub-channels.

While operating in packet idle mode, a mobile station belonging to GPRS MS class A may simultaneously enter the different RR service modes defined in 3GPP TS 44.018 [6]. A mobile station belonging to either of GPRS MS class B or C leaves both packet idle mode and packet transfer modes before entering dedicated mode, group receive mode or group transmit mode.

6.2.2 Packet transfer mode

Packet transfer mode is not applicable to a mobile station supporting DTM that has an ongoing RR connection. A DTM mobile station with an ongoing RR connection and with packet resources allocated is in dual transfer mode (see 6.2.3).

In packet transfer mode, the mobile station is allocated radio resources providing one or more Temporary Block Flows where each TBF may operate on one or more physical channels. Continuous transfer of one or more LLC PDUs is possible. Concurrent TBFs (i.e. one uplink TBF and one downlink TBF) may be established in opposite directions when a mobile station does not support multiple TBF procedures. Multiple concurrent uplink and downlink TBFs may be established when a mobile station does support multiple TBF procedures. Transfer of LLC PDUs in RLC acknowledged or RLC unacknowledged mode is provided. If a mobile station supports multiple TBF procedures and has two or more ongoing TBFs they shall use either GPRS TBF mode or EGPRS TBF mode (i.e. mixing of GPRS and EGPRS TBF modes shall not be supported).

When selecting a new cell, a mobile station leaves the packet transfer mode, enters the packet idle mode where it switches to the new cell, reads the system information and may then resume to packet transfer mode in the new cell.

While operating in packet transfer mode, a mobile station belonging to GPRS MS class A may simultaneously enter the different RR service modes defined in 3GPP TS 44.018. A mobile station belonging to either of GPRS MS class B or C leaves both packet idle mode and packet transfer modes before entering dedicated mode, group receive mode or group transmit mode.

6.2.3 Dual transfer mode

In dual transfer mode, the MS has an ongoing RR connection and is allocated radio resource providing one or more Temporary Block Flows where each TBF may operate on one or more physical channels. Continuous transfer of one or more LLC PDUs is possible. Concurrent TBFs (i.e. one uplink TBF and one downlink TBF) may be established in opposite directions. Multiple concurrent uplink and downlink TBFs may be established for a mobile station that supports multiple TBF procedures. Transfer of LLC PDUs in RLC acknowledged or RLC unacknowledged mode is provided.

While in dual transfer mode the MS performs all the tasks of dedicated mode. In addition, upper layers can require:

- the release of all the packet resources, which triggers the transition to dedicated mode.
- the release of the RR resources, which triggers the transition to idle mode and packet idle mode.

When handed over to a new cell, the MS leaves the dual transfer mode, enters the dedicated mode where it switches to the new cell, may read the system information messages sent on the SACCH and may then enter dual transfer mode in the new cell.

6.2.3a Broadcast/Multicast receive mode

In broadcast/multicast receive mode, the mobile station is allocated radio resources providing one or more p-t-m radio bearers for the reception of MBMS sessions; each p-t-m bearer may operate on one or more physical channels. Transfer of upper layer PDUs in RLC non-persistent mode is provided.

In broadcast/multicast receive mode, the MS listens to the PBCCH and to the paging sub-channel on the PCCCH for the paging group the MS belongs to in packet idle mode. If PBCCH is not present in the cell, the mobile station listens to the BCCH and to the relevant paging sub-channels on the CCCH for the paging group the MS belongs to. However, if the mobile station listens to an MBMS p-t-m bearer for which the network has indicated that system information and paging messages are sent on the PACCH, the MS does not have to listen to the (P)BCCH and, if the MS has an MS_ID on that MBMS p-t-m bearer as well, to the paging sub-channels.

When selecting a new cell, a mobile station leaves the broadcast/multicast receive mode and enters the packet idle mode. After switching to the new cell, the MS may resume the reception of the MBMS session before completing the acquisition of the system information if the location of the p-t-m bearer in the target cell has been provided by the network in the source cell.

A mobile station belonging to either of GPRS MS class A, B or C leaves broadcast/multicast receive mode before entering dedicated mode, group receive mode, group transmit mode, packet transfer mode or dual transfer mode.

6.2.4 Correspondence between Radio Resource operating modes and Mobility Management States

The Mobility Management states are defined in 3GPP TS 23.060 [3]. Table 1 provides the correspondence between Radio Resource states and Mobility Management states:

Table 1a: Correspondence between RR operating modes and MM states (non-DTM capable MS)

RR BSS	Packet transfer mode	Measurement report reception	No state	No state
RR MS	Packet transfer mode	Packet idle mode		Packet idle mode
MM (NSS and MS)	Ready			Standby

Table 1b: Correspondence between RR operating modes and MM states (DTM capable MS)

RR BSS	Dual transfer mode	Dedicated mode	Packet transfer mode	Measurement report reception	No state	Dedicated mode	No state
RR MS				CS idle and packet idle			CS idle and packet idle
GMM (NSS and MS)	Ready					Standby	

Each state is protected by a timer. The timers run in the MS and the network.

Packet transfer mode is guarded by RLC protocol timers.

6.2.5 Transitions between RR operating modes

The RR modes, and therefore the transitions between them, are different for each mode of operation (see 23.060).

Figure 3a shows the four RR states for an MS in mode of operation A that does not support DTM. The four states can be regarded as the combination of two state machines with two RR states each:

- on the circuit switched part, idle mode and dedicated mode
- on the GPRS part, packet idle mode and packet transfer mode

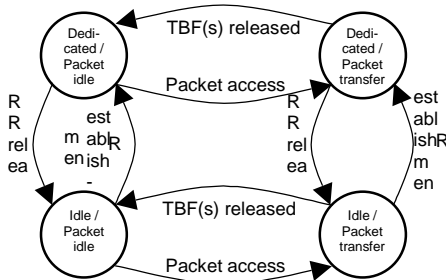

Figure3a: RR operating modes and transitions for class A (DTM not supported)

Figure 3b shows the RR modes and transitions for an MS in modes of operation A (when it supports DTM) and B. In the mode of operation B there are three RR modes:

- (Packet) idle mode
- Packet transfer mode
- Dedicated mode (see 3GPP TS 44.018)

For a mobile station that supports DTM class A mode of operation, there is an additional RR mode: dual transfer mode. This mode can be entered via a packet request procedure while in dedicated mode or RR connection establishment procedure while in packet transfer mode (see 3GPP TS 44.018 and 44.060).

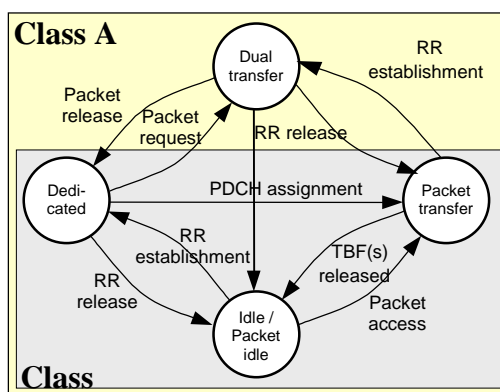

Figure 3b: RR operating modes and transitions for classes A (DTM supported) and B

Figure 3c shows the RR modes and transitions for an MS in mode of operation C. The MS can only be attached to either GSM or GPRS:

- when it is GSM attached (and GPRS detached), there are two RR modes: idle mode and dedicated mode
- when it is GPRS attached (and GSM detached), there are two RR modes: packet idle mode and packet transfer mode.

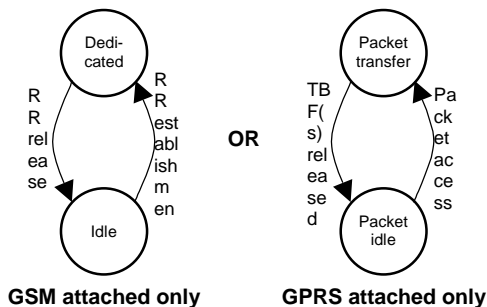

Figure 3c: RR operating modes and transitions for class C

6.3 Layered overview of radio interface

The GPRS radio interface can be modelled as a hierarchy of logical layers with specific functions. An example of such layering is shown in Figure 3d. The various layers are briefly described in the following subclauses.

The physical layer has been separated into two distinct sub-layers defined by their functions:

- Physical RF layer performs the modulation of the physical waveforms based on the sequence of bits received from the Physical Link layer. The Physical RF layer also demodulates received waveforms into a sequence of bits which are transferred to the Physical Link layer for interpretation.
- Physical Link layer provides services for information transfer over a physical channel between the MS and the Network. These functions include data unit framing, data coding, and the detection and correction of physical medium transmission errors. The Physical Link layer uses the services of the Physical RF layer.

The lower part of the data link layer is defined by following functions:

- The RLC/MAC layer provides services for information transfer over the physical layer of the GPRS radio interface. These functions include backward error correction procedures enabled by the selective retransmission of erroneous blocks. The MAC function arbitrates access to the shared medium between a multitude of MSs and the Network. The RLC/MAC layer uses the services of the Physical Link layer. The layer above RLC/MAC (i.e., LLC described in 3GPP TS 23.060 [3] and defined in 3GPP TS 44.064 [8]) uses the services of the RLC/MAC layer on the Um interface.

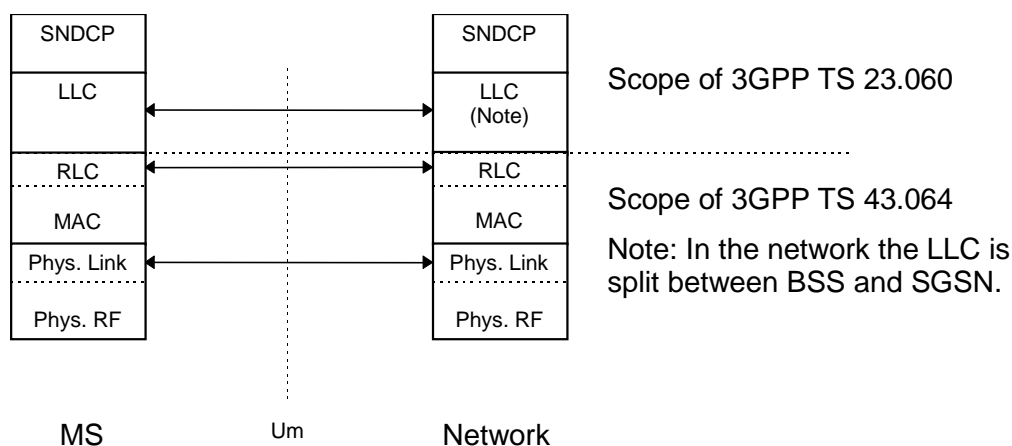

Figure 3d: GPRS MS – Network Reference Model

6.4 Physical RF Layer

The GSM Physical RF layer is defined in 3GPP TS 45.0xx series recommendations, which specify among other things:

- The carrier frequencies characteristics and GSM radio channel structures (3GPP TS 45.002 [11]);
- The modulation of the transmitted wave forms and the raw data rates of GSM channels (3GPP TS 45.004 [13]); and
- The transmitter and receiver characteristics and performance requirements (3GPP TS 45.005 [14]).

In the case of EGPRS, the modulation format is inherently signalled by the rotation factor of the training sequences as specified in 3GPP TS 45.004 [13] and 3GPP TS 45.002 [11], enabling blind detection in the receiver.

6.5 Physical Link Layer

The Physical Link layer operates above the physical RF layer to provide a physical channel between the MS and the Network.

6.5.1 Layer Services

The purpose of the Physical Link layer is to convey information across the GSM radio interface, including RLC/MAC information. The Physical Link layer supports multiple MSs sharing a single physical channel.

The Physical Link layer provides communication between MSs and the Network.

The Physical Link layer control functions provide the services necessary to maintain communications capability over the physical radio channel between the Network and MSs. Radio subsystem link control procedures are currently specified in 3GPP TS 45.008 [15]. Network controlled handovers are not used in the GPRS service. MS performed cell-reselection is used, see subclause 6.5.6.

6.5.2 Layer Functions

The Physical Link layer is responsible for:

- Forward Error Correction (FEC) coding, allowing the detection and correction of transmitted code words and the indication of uncorrectable code words. The coding schemes are described in subclause 6.5.5.
- Interleaving of one Radio Block over four bursts in consecutive TDMA frames, as specified in 3GPP TS 45.003 [12].
- Procedures for detecting physical link congestion.

The Physical Link layer control functions include:

- Synchronisation procedures, including means for determining and adjusting the MS Timing Advance to correct for variances in propagation delay , 3GPP TS 45.010 [16];
- Monitoring and evaluation procedures for radio link signal quality;
- Cell (re-)selection procedures;
- Transmitter power control procedures; and
- Battery power conservation procedures, e.g. Discontinuous Reception (DRX) procedures.

6.5.3 Service Primitives

Table 2 lists the service primitives provided by the Physical Link layer to RLC/MAC layer. More detailed description is given in 3GPP TS 44.004 [4].

Table 2: Service primitives provided by the Physical link layer

Name	Request	indication	response	confirm	Comments
PH-DATA	X	X			Used to pass message units containing frames used for RLC/MAC layer respective peer-to-peer communications to and from the physical layer.
PH-RANDOM ACCESS	X	X		X	Used to request and confirm (in the MS) the sending of a random access frame and to indicate (in the network) the arrival of a random access frame.
PH-CONNECT		X			Used to indicate that the physical connection on the packet data physical channel has been established.
PH-READY-TO-SEND	X				Used by the physical layer to trigger, if applicable, piggy backing, the start of timer for the RLC/MAC layer and the forwarding a data unit to the physical layer
PH-EMPTY-FRAME	X				Used by the RLC/MAC layer to indicate that no frame has to be transmitted after receiving the PH-READY-TO-SEND primitive

6.5.4 Radio Block Structure

Different Radio Block structures for data transfer and control message transfer purposes are defined. The Radio Block structure for data transfer is different for GPRS and EGPRS, whereas the same Radio Block structure is used for control messages. For detailed definition of radio block structure, see 3GPP TS 44.060 [7].

For GPRS, a Radio Block for data transfer consists of one MAC Header, one RLC header and one RLC Data Block. It is always carried by four normal bursts.

Radio Block			
MAC header	RLC header	RLC data	BCS

Figure 4: Radio Block structure for data transfer for GPRS

The MAC header contains control fields which are different for uplink and downlink directions. The MAC header has constant length, 8 bits.

The RLC header contains control fields which are different for uplink and downlink directions. The RLC header has variable length.

The RLC data field contains octets from one or more LLC PDUs.

The Block Check Sequence (BCS) is used for error detection.

For EGPRS, a Radio Block for data transfer consists of one RLC/MAC header and one or two RLC Data Blocks. It is always carried by four normal bursts. The interleaving depends on the MCS used.

Radio Block			
RLC/MAC header	HCS	RLC data	BCS

Figure 5: Radio Block structure for data transfer for EGPRS

The RLC/MAC header contains control fields which are different for uplink and downlink directions. The RLC/MAC header has variable length.

The RLC data field contains octets from one or more LLC PDUs.

The Block Check Sequence (BCS) is used for error detection of the data part.

The Header Check Sequence (HCS) is used for error detection of the header part.

The header part is independently coded from the data part and has its own check sequence. Tail biting (i.e. no explicit tail bits are appended before encoding. The encoder is initialised with the last information bits enabling tail biting decoding in the receiver) is used to reduce the size of the header.

For GPRS and EGPRS, a Radio Block for control message transfer consists of one MAC header and one RLC/MAC Control Block. It is always carried by four normal bursts.

Radio Block		
MAC header	RLC/MAC Control Message	BCS

Figure 6: Radio Block structure for control message for GPRS and EGPRS

The MAC header contains control fields which are different for uplink and downlink directions. The MAC header has constant length, 8 bits.

The Block Check Sequence (BCS) is used for error detection.

The RLC/MAC Control message field contains one RLC/MAC control message.

6.5.5 Channel Coding

NOTE: The text in this subclause is informative. The normative text is in 3GPP TS 45.003 [12]. Where there is a conflict between these descriptions, the normative text has precedence.

Four coding schemes, CS-1 to CS-4, are defined for the GPRS packet data traffic channels. For all other GPRS packet control channels than Packet Random Access Channel (PRACH) and Packet Timing Advance Control Channel on Uplink (PTCCH/U), coding scheme CS-1 is always used. For access bursts on PRACH, two coding schemes are specified.

All coding schemes (CS-1 to CS-4) are mandatory for MSs supporting GPRS. CS-1 is mandatory for a network supporting GPRS.

Nine modulation and coding schemes, MCS-1 to MCS-9, are defined for the EGPRS packet data traffic channels. For all EGPRS packet control channels the corresponding GPRS control channel coding is used. MSs supporting EGPRS shall support MCS-1 to MCS-9 in downlink and MCS-1 to MCS-4 in uplink. In case an MS supporting EGPRS is 8-PSK capable in uplink, it shall also support MCS-5 to MCS-9 in uplink. A network supporting EGPRS may support only some of the MCSs.

6.5.5.1 Channel coding for PDTCH

6.5.5.1.1 Channel coding for GPRS PDTCH

Four different coding schemes, CS-1 to CS-4, are defined for the GPRS Radio Blocks carrying RLC data blocks. The block structures of the coding schemes are shown in Figure 7 and Figure 8.

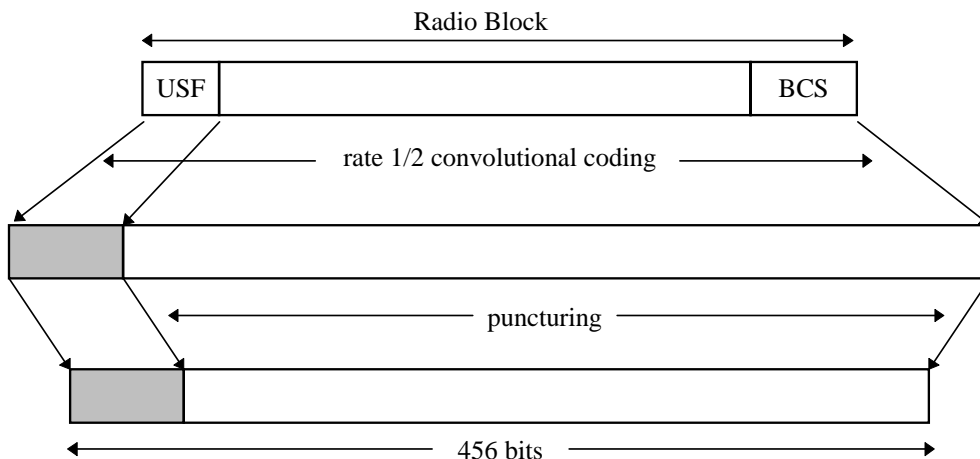

Figure 7: Radio Block structure for CS-1 to CS-3

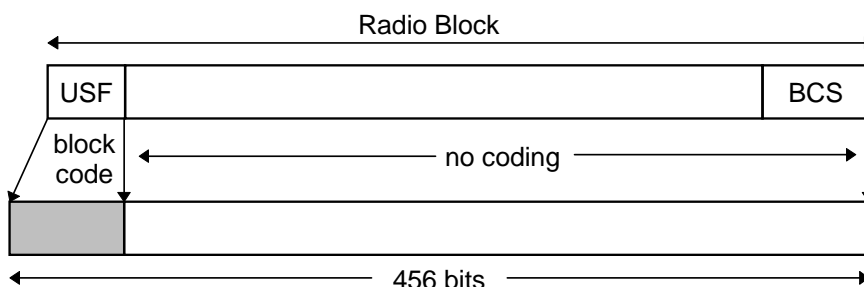

Figure 8: Radio Block structure for CS-4

The first step of the coding procedure is to add a Block Check Sequence (BCS) for error detection.

For CS-1 - CS-3, the second step consists of pre-coding USF (except for CS-1), adding four tail bits and a half rate convolutional coding for error correction that is punctured to give the desired coding rate.

For CS-4 there is no coding for error correction.

The details of the codes are shown in table 3, including:

- the length of each field;
- the number of coded bits (after adding tail bits and convolutional coding);
- the number of punctured bits;
- the data rate.

Table 3: Coding parameters for the GPRS coding schemes.

Scheme	Code rate	USF	Pre-coded USF	Radio Block excl. USF and BCS	BCS	Tail	Coded bits	Punctured bits	Data rate kb/s (Note 1)	Data rate kb/s (Note 2)
CS-1	1/2	3	3	181	40	4	456	0	9.05	8.0
CS-2	≈2/3	3	6	268	16	4	588	132	13.4	12.0
CS-3	≈3/4	3	6	312	16	4	676	220	15.6	14.4
CS-4	1	3	12	428	16	-	456	-	21.4	20.0

NOTE 1: This value includes the RLC header, the MAC header (excluding the USF), the spare bits and RLC information.

NOTE 2: This value includes only RLC information.

CS-1 is the same coding scheme as specified for SACCH in 3GPP TS 45.003 [12]. It consists of a half rate convolutional code for FEC and a 40 bit FIRE code for BCS (and optionally FEC).

CS-2 and CS-3 are punctured versions of the same half rate convolutional code as CS-1 for FEC.

CS-4 has no FEC.

CS-2 to CS-4 use the same 16 bit CRC for BCS. The CRC is calculated over the whole uncoded RLC Data Block including MAC Header.

The USF has 8 states, which are represented by a binary 3 bit field in the MAC Header.

For CS-1, the whole Radio Block is convolutionally coded and USF needs to be decoded as part of the data.

All other coding schemes generate the same 12 bit code for USF. The USF can be decoded either as a block code or as part of the data.

In order to simplify the decoding, the stealing bits (defined in 3GPP TS 45.003 [12]) of the block are used to indicate the actual coding scheme.

6.5.5.1.2 Channel coding for EGPRS PDTCH

Nine different modulation and coding schemes, MCS-1 to MCS-9, are defined for the EGPRS Radio Blocks (4 bursts, 20ms) carrying RLC data blocks. The block structures of the coding schemes are shown from Figure 10 to Figure 18 and in Table 4. A general description of the MCSs is given in Figure 9.

The MCSs are divided into different families A, B and C. Each family has a different basic unit of payload: 37 (and 34), 28 and 22 octets respectively. Different code rates within a family are achieved by transmitting a different number of payload units within one Radio Block. For families A and B, 1, 2 or 4 payload units are transmitted, for family C, only 1 or 2 payload units are transmitted.

When 4 payload units are transmitted (MCS-7, MCS-8 and MCS-9), these are splitted into two separate RLC blocks (i.e. with separate sequence numbers and BCSs). These blocks in turn are interleaved over two bursts only, for MCS-8 and MCS-9. For MCS-7, these blocks are interleaved over four bursts. All the other MCSs carry one RLC block which is interleaved over four bursts. When switching to MCS-3 or MCS-6 from MCS-8, 6 padding octets are added to the data octets.

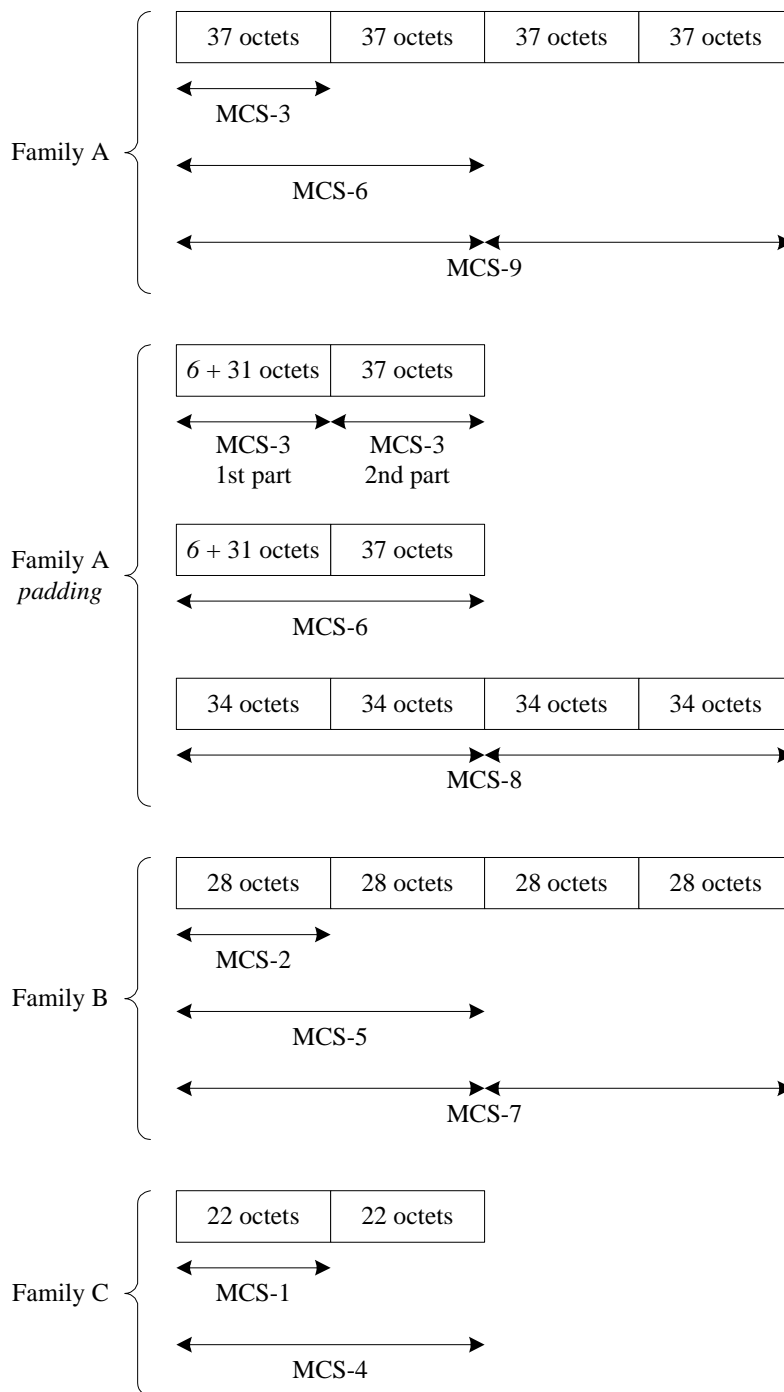

Figure 9: General description of the Modulation and Coding Schemes for EGPRS

To ensure strong header protection, the header part of the Radio Block is independently coded from the data part of the Radio Block (8 bit CRC calculated over the header -excl. USF- for error detection, followed by rate 1/3 convolutional coding –and eventually puncturing- for error correction). Three different header formats are used, one for MCS-7, MCS-8 and MCS-9, one for MCS-5 and MCS-6 and one for MCS-1 to MCS-4. The two first formats are for 8PSK modes, the difference being in the number of Sequence Numbers carried (2 for MCS-7, -8 and -9, 1 for MCS-5 and -6). The third format is common to all GMSK modes. The header is always interleaved over four bursts. See 3GPP TS 44.060 [7] for more details.

Following figures show the coding and puncturing for all the Modulation and Coding Schemes, for downlink traffic.

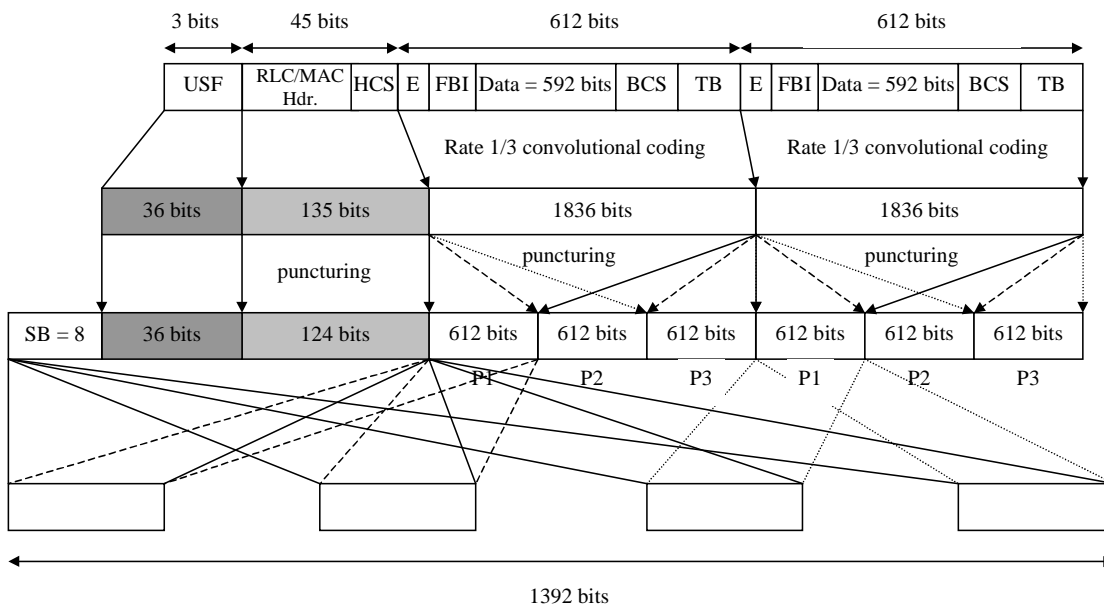

Figure 10: Coding and puncturing for MCS-9; uncoded 8PSK, two RLC blocks per 20ms

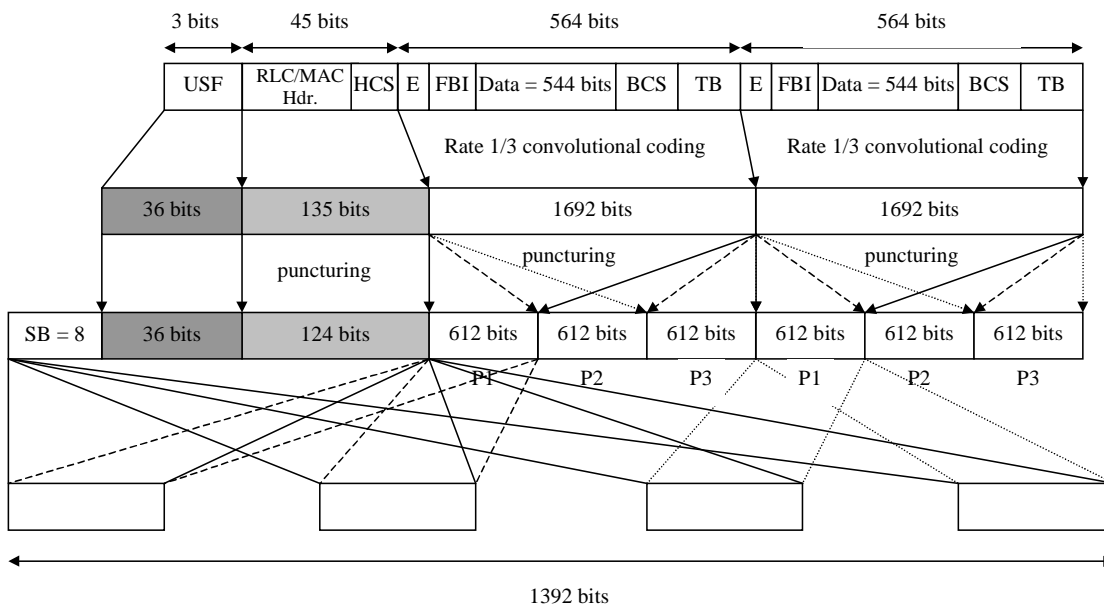

Figure 11: Coding and puncturing for MCS-8; rate 0.92 8PSK, two RLC blocks per 20ms

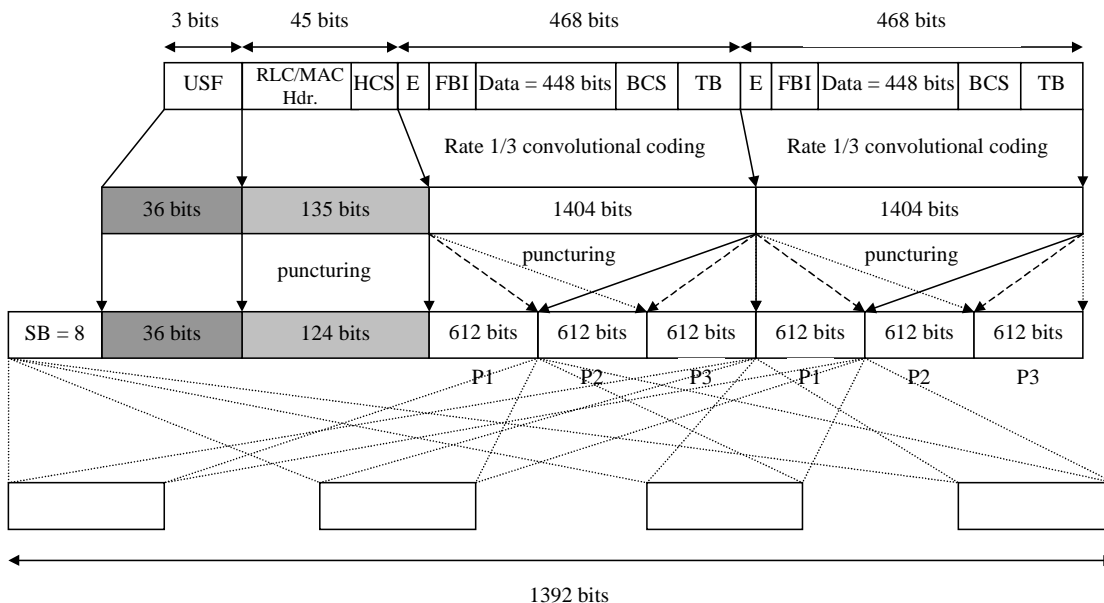

Figure 12: Coding and puncturing for MCS-7; rate 0.76 8PSK, two RLC blocks per 20ms

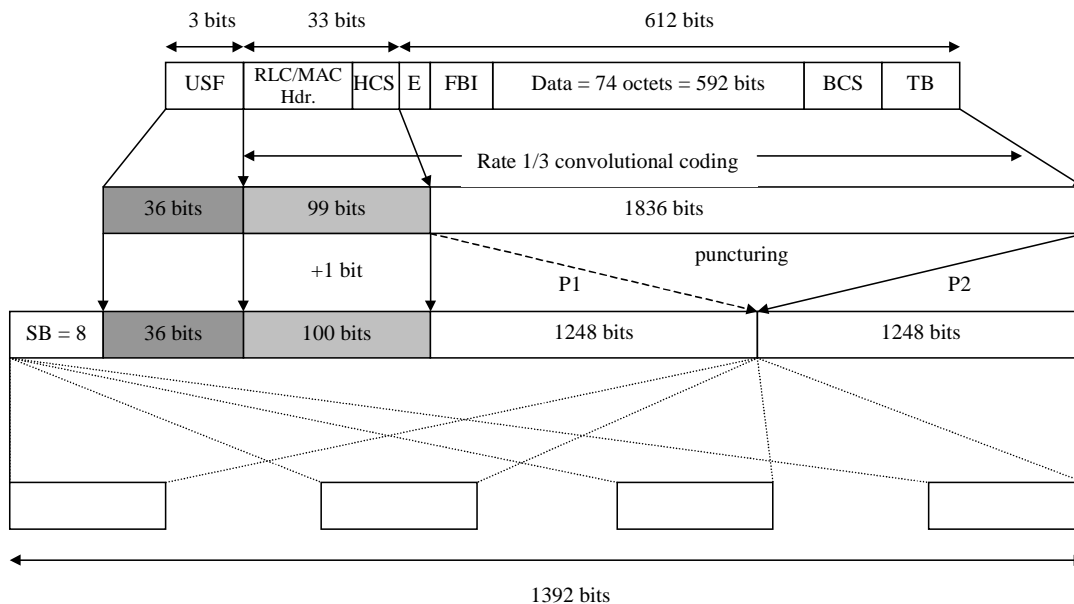

Figure 13: Coding and puncturing for MCS-6; rate 0.49 8PSK, one RLC block per 20 ms

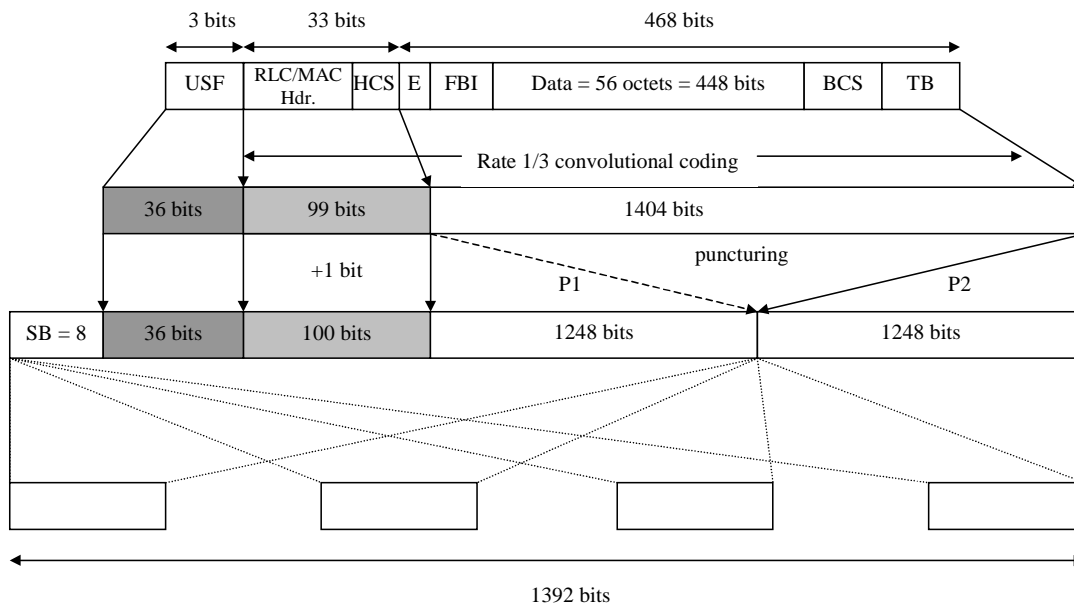

Figure 14: Coding and puncturing for MCS-5; rate 0.37 8PSK, one RLC block per 20 ms

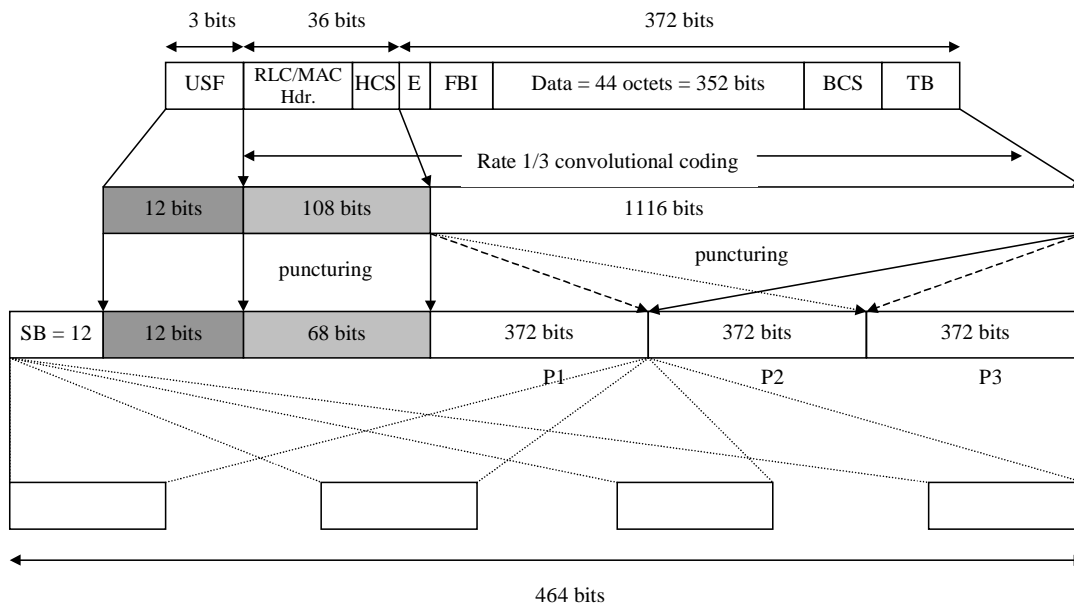

Figure 15: Coding and puncturing for MCS-4; uncoded GMSK, one RLC block per 20 ms

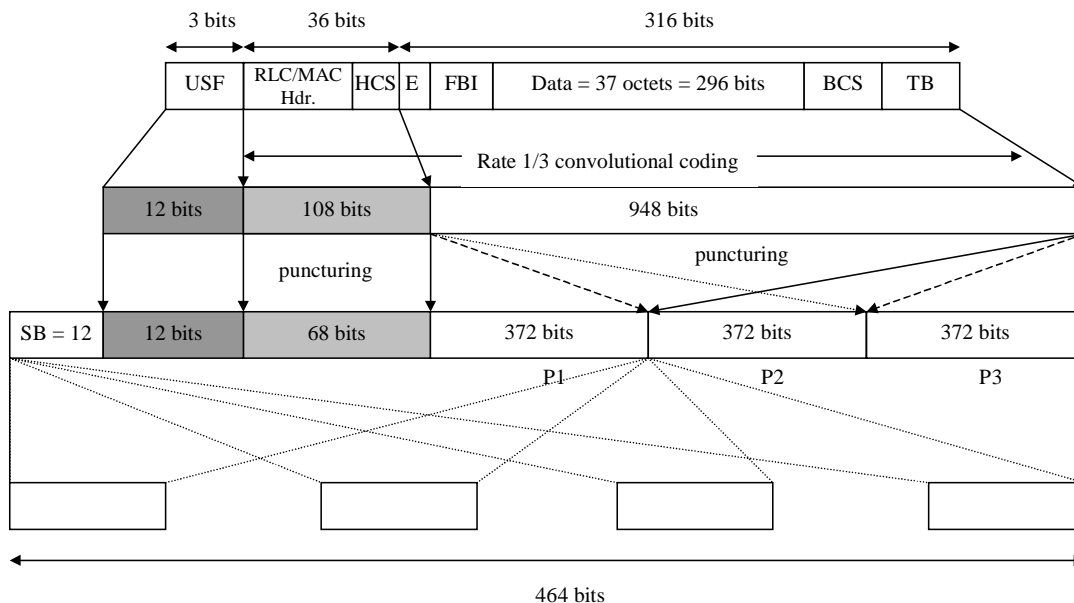

Figure 16: Coding and puncturing for MCS-3; rate 0.85 GMSK, one RLC block per 20 ms

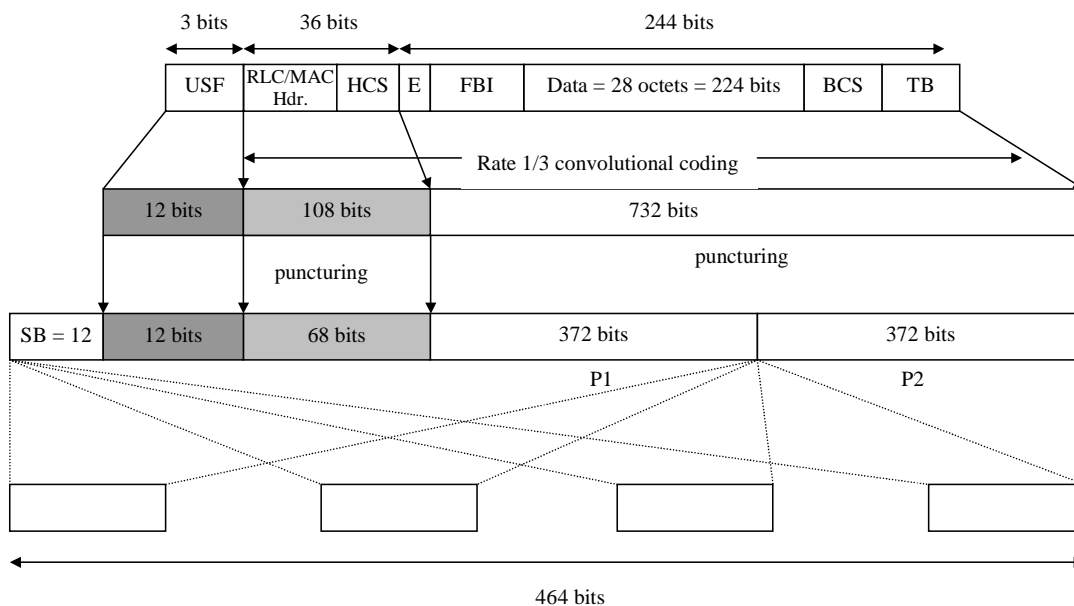

Figure 17: Coding and puncturing for MCS-2; rate 0.66 GMSK, one RLC block per 20 ms

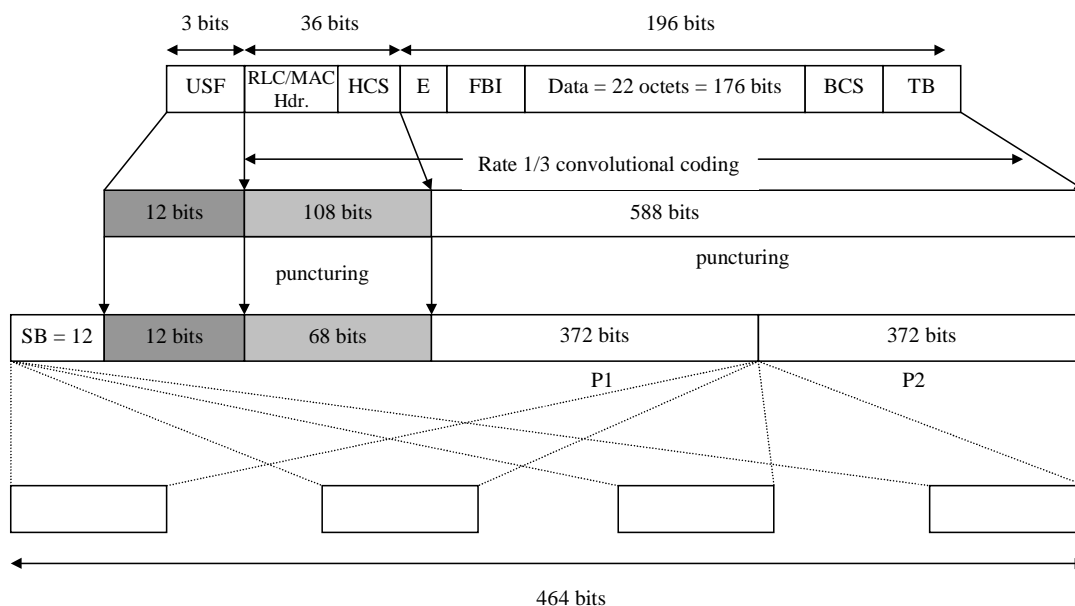

Figure 18: Coding and puncturing for MCS-1; rate 0.53 GMSK, one RLC block per 20 ms

The USF has 8 states, which are represented by a binary 3 bit field in the MAC Header. The USF is encoded to 12 symbols similarly to GPRS, (i.e., 12 bits for GMSK modes and 36 bits for 8PSK modes).

The FBI (Final Block Indicator) bit and the E (Extension) bit defined in 3GPP TS 44.060 [7] do not require extra protection: they are encoded along with the data part.

The first step of the coding procedure is to add a Block Check Sequence (BCS) for error detection.

The second step consists of adding six tail bits (TB) and a 1/3 rate convolutional coding for error correction that is punctured to give the desired coding rate. The P_i for each MCS correspond to different puncturing schemes achieving the same coding rate. The bits indicating the MCS used are in the coded header. In both 8PSK and GMSK modes the stealing bits (SB) of the block are used to indicate the header formats. There are eight SB for 8PSK mode which allow to indicate four header formats. There are twelve SB for GMSK mode which allow to indicate two header formats: the first eight of the twelve SB indicate CS-4.

The details of the EGPRS coding schemes are shown in table 4. The data rates exclude the RLC/MAC header(s).

Table 4: Coding parameters for the EGPRS coding schemes

Scheme	Code rate	Header Code rate	Modulation	RLC blocks per Radio Block (20ms)	Raw Data within one Radio Block	Family	BCS	Tail payload	HCS	Data rate kb/s	
MCS-9	1.0	0.36	8PSK	2	2x592	A	2x12	2x6	8	59.2	
MCS-8	0.92	0.36		2	2x544	A					54.4
MCS-7	0.76	0.36		2	2x448	B					44.8
MCS-6	0.49	1/3		1	592 48+544	A	12	6		29.6 27.2	
MCS-5	0.37	1/3	1	448	B					22.4	
MCS-4	1.0	0.53	GMSK	1	352	C				17.6	
MCS-3	0.85	0.53		1	296 48+248 and 296	A				14.8 13.6	
MCS-2	0.66	0.53		1	224	B				11.2	
MCS-1	0.53	0.53		1	176	C				8.8	
NOTE: The italic captions indicate the 6 octets of padding when retransmitting an MCS-8 block with MCS-3 or MCS-6. For MCS-3, the 6 octets of padding are sent every second block (see 3GPP TS 44.060).											

6.5.5.2 Channel coding for PACCH, PBCCH, PAGCH, PPCH, PNCH and PTCCH

The channel coding for the PACCH, PBCCH, PAGCH, PPCH, PNCH and downlink PTCCH is the same as the coding scheme CS-1 presented in subclause 6.5.5.1.

The coding scheme used for uplink PTCCH is the same as for PRACH.

6.5.5.2a Channel coding for CPBCCH, CPAGCH, CPPCH, CPNCH, and CSCH

The channel coding for the CPBCCH, CPAGCH, CPPCH, and CPNCH is the same as the coding scheme CS-1 presented in subclause 6.5.5.1. The channel coding for the CSCH is identical to SCH.

6.5.5.3 Channel Coding for the PRACH, CPRACH and MPRACH

Two types of packet access burst may be transmitted on the PRACH and MPRACH: an 8 information bits access burst or an 11 information bits access burst called the extended packet access burst. The mobile shall support both access bursts. The channel coding for both burst formats is indicated in the following subclauses. Only the 11 information bits access burst may be transmitted on the CPRACH.

6.5.5.3.1 Coding of the 8 data bit Packet Access Burst

The channel coding used for the burst carrying the 8 data bit packet access uplink message is identical to the coding of the access burst as defined for random access channel in 3GPP TS 45.003 [12].

6.5.5.3.2 Coding of the 11 data bit Packet Access Burst

The channel coding for 11 bit access burst is the punctured version of the same coding as used for 8 bit access burst.

6.5.6 Cell Re-selection

NOTE: The text in this subclause is informative. The normative text is in 3GPP TS 43.022 and 3GPP TS 45.008 [15]. Where there is a conflict between these descriptions, the normative text has precedence.

In GPRS Packet Idle and Packet Transfer modes, cell re-selection is performed by the MS, except for

- a class A MS (see 3GPP TS 22.060 [2]) while in dedicated mode in which case the cell is determined by the network according to the handover procedures;
- when the MS has been set in network control mode NC2 by the network or
- when the MS is in Cell Change Notification (CCN) mode (see subclause 6.5.6.4).

The new cell re-selection criteria C31 and C32 are provided as a complement to the current GSM cell re-selection criteria. This provides a more general tool to make cell planning for GPRS as similar to existing planning in GSM as possible. C31 is a signal strength criterion used to decide whether prioritised cell re-selection shall be used. For cells that fulfil the C31 criterion, the cell with highest priority class shall be selected. If more than one cell has the highest priority, the one of those with the highest C32 value shall be selected. If no cell fulfils the C31 criterion, the one among all cells with the highest C32 value shall be selected.

C32 is an improvement of C2. It applies an individual offset and hysteresis value to each pair of cells, as well as the same temporary offsets as for C2. Additional hysteresis values apply for a cell re-selection that requires cell or routing area update.

Cell re-selection procedure apply to the MSs attached to GPRS if a PBCCH exists in the serving cell. If the PBCCH is not allocated, then the MS shall perform cell re-selection according to the C2 criteria.

In addition, the network may control the cell re-selection as described in subclause 6.5.6.3 and/or assist the MS in the cell re-selection procedure as described in subclause 6.5.6.4.

6.5.6.1 Measurements for Cell Re-selection

The MS shall measure the received RF signal strength on the BCCH frequencies of the serving cell and the neighbour cells as indicated in the BA-GPRS list, and calculate the received level average (RLA) for each frequency, as specified in 3GPP TS 45.008 [15]. In addition the MS shall verify the BSIC of the cells. Only channels with the same BSIC as broadcast together with BA-GPRS on PBCCH shall be considered for re-selection.

A COMPACT capable MS shall in addition perform the above tasks for any CPBCCH, either transmitted in the serving cell or indicated, by way of frequency and time group in the BA-GPRS list.

Any cell having a CPBCCH indicated in the BA-GPRS list shall be time synchronized to that cell, as specified in 3GPP TS 45.010 [16].

When the number of downlink PDCHs assigned to certain types of multislot MS (see 3GPP TS 45.002 [11] , annex B) does not allow them to perform measurements within the TDMA frame, the network shall provide measurement windows to ensure that the MS can perform a required number of measurements.

6.5.6.2 Broadcast Information

The PBCCH broadcasts GPRS specific cell re-selection parameters for serving and neighbour cells, including the BA (GPRS) list. A BA (GPRS) identifies the neighbour cells, including BSIC, that shall be considered for GPRS cell (re-selection (not necessary the same as for GSM in Idle or circuit switched mode)).

6.5.6.3 Optional measurement reports and network controlled cell re-selection

It shall be possible for the network to order the mobile stations to send measurement reports to the network and to suspend its normal cell re-selection, and instead to accept decisions from the network. This applies to both Packet idle mode and Packet transfer mode.

The degree to which the mobile station shall resign its radio network control shall be variable, and be ordered in detail by the parameter NETWORK_CONTROL_ORDER.

Two sets of parameters are broadcast on PBCCH and are valid in Packet transfer and Packet idle modes respectively. NETWORK_CONTROL_ORDER can also be sent individually to an MS on PACCH, in which case it overrides the broadcast parameter.

When a class A mobile station is simultaneously involved in a circuit switched service and in a GPRS transfer, the network controlled cell re-selection procedures (NC1 or NC2 modes of operation) should not be used.

In this case, handover for the circuit switched service has precedence over GPRS network controlled cell re-selection, and the MS shall stop sending measurement reports and ignore cell change orders.

6.5.6.4 Network Assisted Cell Change

The Network Assisted Cell Change option adds a possibility to

- a) minimize the service outage time for an MS in the cell re-selection process,
- b) delay the cell re-selection until complete RLC-SDUs have been transferred.

This is achieved without forcing the MS into either mode NC1 or NC2 and consequently eliminates the need to load the radio path with measurement reports (see subclause 6.5.6.3).

The procedures related to Network Assisted Cell Change are optional for the network and mandatory for an MS.

Network Assisted Cell Change consists mainly of two parts

- One part that can assist an MS in packet transfer mode with neighbour cell system information required for initial packet access after a cell change;
- One part in which the mobile station notifies the network when the cell change criteria is fulfilled and delays the cell re-selection a short time to let the network respond with neighbour cell system information (CCN mode procedures).

A mobile station in Packet Transfer mode may receive neighbour cell system information on PACCH. The neighbour cell information may consist of PSI1, PSI2 and PSI14 if a PBCCH is allocated in the target cell, or SI3, SI13 and SI1 (if available) if no PBCCH is allocated. The information shall be stored by the mobile station and is valid for 30 seconds. During that period the MS may use the information for initial access when entering the addressed neighbour cell.

The neighbour cell system information is contained in the Packet Neighbour Cell Data message.

The network indicates use of CCN on BCCH and PBCCH. If indicated or individually ordered by the network and when the MS is in packet transfer mode and in NC0 or NC1 mode but not in dedicated mode or in dual transfer mode, the MS shall enable CCN. When enabled, and when the criteria for cell re-selection are fulfilled, the MS shall enter CCN mode and notify the network. While in CCN mode the MS shall not change cell.

In the notification to the network, the MS shall report a proposed cell identity and measurement results for the proposed and for other neighbour cells if available. The MS shall leave the CCN mode when either

- The network responds with a Packet Cell Change Continue or a Packet Cell Change Order message or
- A certain time has elapsed or
- The MS enters Packet Idle Mode or
- The criteria for camping on the old cell is no longer fulfilled (see 3GPP TS 45.008).

If the MS is in NC2 mode, dedicated mode or in dual transfer mode, the CCN mode is not applicable.

6.5.7 Timing Advance

NOTE: The text in this subclause is informative. The normative text is in 3GPP TS 44.060 [7] and 3GPP TS 45.010 [16]. Where there is a conflict between these descriptions, the normative text has precedence.

The timing advance procedure is used to derive the correct value for timing advance that the MS has to use for the uplink transmission of radio blocks. This procedure is not used in dual transfer mode, in which case the timing advance procedures for dedicated mode are used.

The timing advance procedure comprises two parts:

- initial timing advance estimation;

- continuous timing advance update.

6.5.7.1 Initial timing advance estimation

The initial timing advance estimation is based on the single access burst carrying the Packet Channel Request. The Packet Uplink Assignment or Packet Downlink Assignment then carries the estimated timing advance value to the MS. This value shall be used by the MS for the uplink transmissions until the continuous timing advance update provides a new value (see subclause 6.5.7.2.). Two special cases exist:

- when Packet Queuing Notification is used the initial estimated timing advance may become too old to be sent in the Packet Downlink (/Uplink) Assignment
- when Packet Downlink (/Uplink) Assignment is to be sent without prior paging (i.e., in the Ready state), no valid timing advance value may be available.

Then the network has three options:

- Packet Polling Request can then be used to trigger the transmission of Packet Control Acknowledgement. This message can be formatted as four access burst from which the timing advance can be estimated.
- Packet Downlink (/Uplink) Assignment can be sent without timing advance information. In that case it is indicated to the MS that it can only start the uplink transmission after the timing advance is obtained by the continuous timing advance update procedure.
- The poll bit in the Packet Downlink (/Uplink) Assignment message can be set to trigger the transmission of Packet Control Acknowledgement. This can be used if System information indicates that acknowledgement is access bursts.

For the case where timing advance information is not provided in the assignment message, the mobile is not allowed to send normal bursts on the uplink until it receives a valid timing advance either in Packet Timing Advance/Power Control message or through the continuous timing advance procedure.

6.5.7.2 Continuous timing advance update

MS in Packet transfer mode shall use the continuous timing advance update procedure. The continuous timing advance update procedure is carried on the PTCCH allocated to the MS.

For uplink packet transfer, within the Packet Uplink Assignment, the MS is assigned Timing Advance Index (TAI) and the PTCCH.

For downlink packet transfer, within the Packet Downlink Assignment, the MS is assigned Timing Advance Index (TAI) and the PTCCH.

The TAI specifies the PTCCH sub-channel used by the MS.

On the uplink, the MS shall send in the assigned PTCCH access burst, which is used by the network to derive the timing advance.

The network analyses the received access burst and determines new timing advance values for all MSs performing the continuous timing advance update procedure on that PDCH. The new timing advance values shall be sent via a downlink signalling message (TA-message) on PTCCH/D. Network can send timing advance information also in Packet Timing Advance/Power Control and Packet Uplink Ack/Nack messages on PACCH.

6.5.7.2.1 Mapping on the multiframe structure

Figure 19 shows the mapping of the uplink access bursts and downlink TA-messages on groups of eight 52-multiframes:

- the TAI value shows the position where a slot is reserved for a MS to send an access burst (e.g. T1 means 52-multiframe number n and idle slot number 2). TAI value defines the used PTCCH sub-channel.
- every second PDCH multiframe starts a downlink TA-message.

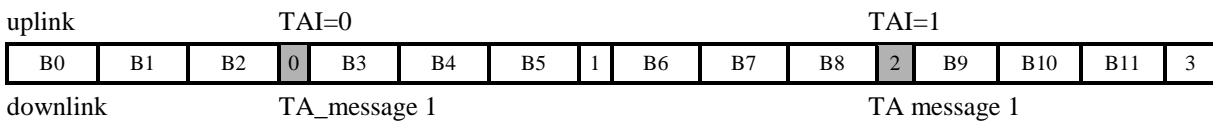
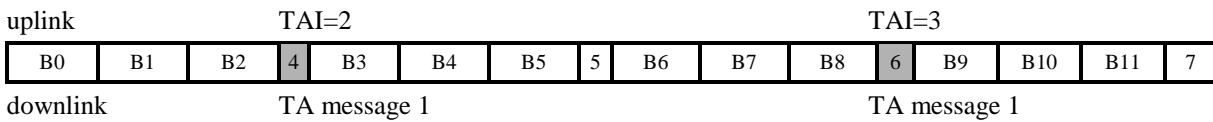
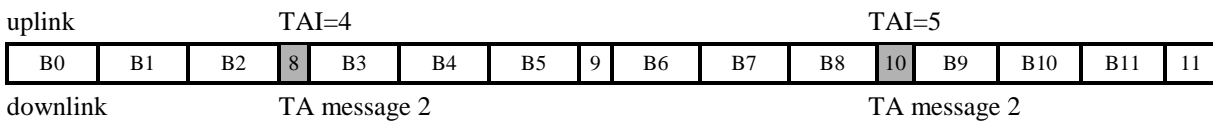
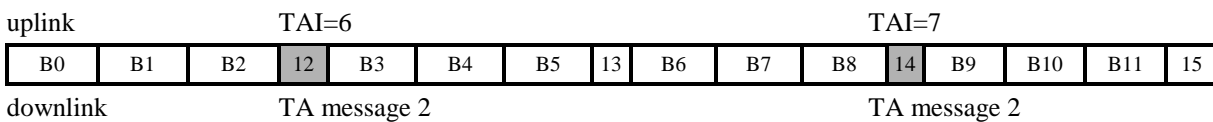
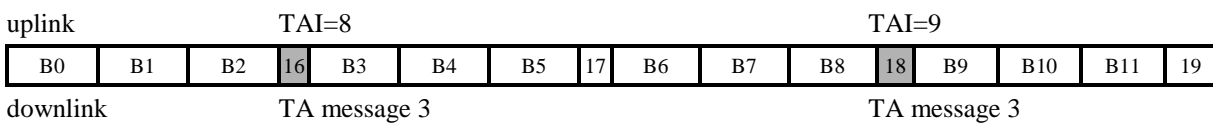
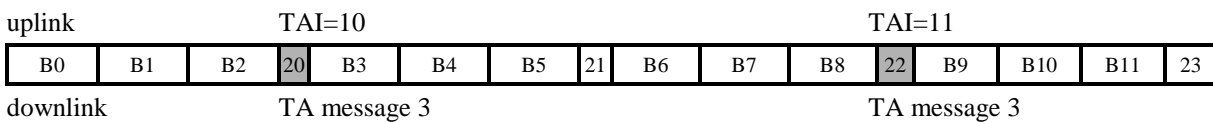
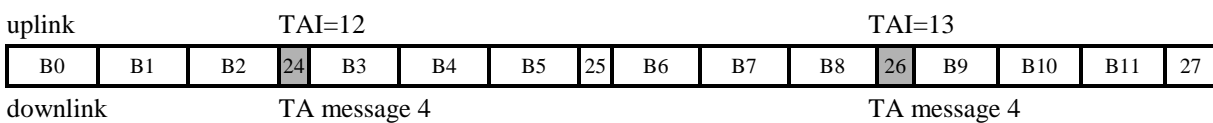
52-multiframe number n:52-multiframe number n + 1:52-multiframe number n + 2:52-multiframe number n + 3:52-multiframe number n + 4:52-multiframe number n + 5:52-multiframe number n + 6:

52-multiframe number n + 7:

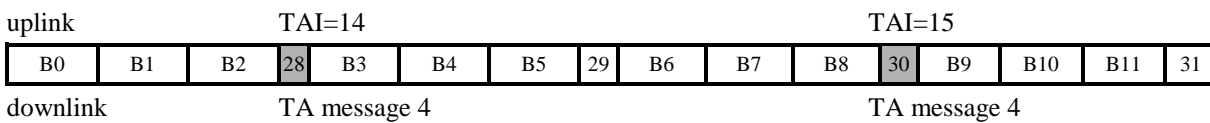

B0 - B11 = Radio blocks

Idle frames are numbered from 1 to 31 [odd numbers]

PTCCH frames are numbered from 0 to 30 [even numbers]

Figure 19: Mapping of the uplink access bursts and downlink timing advance signalling messages

The BTS shall update the timing advance values in the next TA-message following the access burst. To illustrate this, an MS that transmits an access burst in frames numbered 0, 2, 4, or 6 receives its updated timing advance value in TA message 2. This MS can also find this updated timing advance value in subsequent TA messages 3, 4, and 1, but only has to read these if TA message 2 was not received correctly.

An MS entering the Transfer state shall ignore the TA-messages until the MS has sent its first access burst. This is to avoid the use of timing advance values, derived from access bursts sent by the MS that previously used the same TAI.

6.5.8 Power control procedure

Power control shall be supported in order to improve the spectrum efficiency and to reduce the power consumption in the MS.

For the uplink, the MS shall follow a flexible power control algorithm, which the network can optimise through a set of parameters. It can be used for both open loop and closed loop power control.

For the downlink, the power control is performed in the BTS. Therefore, there is no need to specify the actual algorithms, but information about the downlink performance is needed. Therefore the MSs have to transfer Channel Quality Reports to the BTS.

For the detailed specification of power control see 3GPP TS 45.008 [15].

6.5.8.1 MS output power

The MS shall calculate the RF output power value, P_{CH} , to be used on each individual uplink PDCH assigned to the MS:

$$P_{CH} = \min((\Gamma_0 - \Gamma_{CH} - \alpha * (C + 48)), P_{MAX})$$

where

Γ_{CH} is an MS and channel specific power control parameter. It is sent to the MS in any resource assigning message. Further, the network can, at any time during a packet transfer, send new Γ_{CH} values to the MS on the downlink PACCH.

Γ_0 is a frequency band dependent constant.

$\alpha \in [0,1]$ is a system parameter. Its default value is broadcast on the PBCCH. Further, MS and channel specific values can be sent to the MS together with Γ_{CH} .

C is the received signal level at the MS.

P_{MAX} is the maximum allowed output power in the cell.

All power values are expressed in dBm.

P_{CH} is not used to determine the output power when accessing the cell on PRACH or RACH, in which case P_{MAX} shall be used.

6.5.8.2 BTS output power

The BTS shall use constant power on those PDCH radio blocks which contain PBCCH or which may contain PPCH. This power may be lower than the output power used on BCCH. The difference shall be broadcast on PBCCH.

On the other PDCH radio blocks, downlink power control may be used. Thus, a procedure may be implemented in the network to control the power of the downlink transmission based on the Channel Quality Reports.

The network shall ensure that the output power is sufficient for the MS for which the RLC block is intended as well as the MS(s) for which the USF is intended, and that for each MS in packet transfer mode, at least one downlink RLC block per multiframe is transmitted with an output power that is sufficient for that MS, on a block monitored by that MS.

6.5.8.3 Measurements at MS side

A procedure shall be implemented in the MS to monitor periodically the downlink Rx signal level and quality from its serving cell.

6.5.8.3.1 Deriving the C value

This subclause comprises information about how the MS shall derive the C value in the power control equation.

The MS shall periodically measure the received signal strength.

In packet idle mode, the MS shall measure the signal strength of the PCCCH or, if PCCCH is not existing, the BCCH.

In packet transfer mode, the MS shall measure the signal strength on BCCH. The same measurements as for cell re-selection are used (see 6.5.6.1.). Alternatively, if indicated by a broadcast parameter, the MS shall measure the signal strength on one of the PDCHs where the MS receives PACCH. This method is suitable in the case where BCCH is in another frequency band than the used PDCHs. It requires that constant output power is used on all downlink PDCH blocks.

The MS shall measure the signal strength of each radio block monitored by the MS. The C value is achieved by filtering the signal strength with a running average filter. The filtering shall normally be continuous between the packet modes. The different filter parameters for the packet modes are broadcast on PBCCH or, if PBCCH does not exist, on BCCH.

The variance of the received signal level within each block shall also be calculated. The filtered value SIGN_VAR shall be included in the channel quality report.

6.5.8.3.2 Derivation of Channel Quality Report

The channel quality is measured as the interference signal level during the idle frames of the multiframe, when the serving cell is not transmitting.

In packet transfer mode, the MS shall measure the interference signal strength of all eight channels (slots) on the same carrier as the assigned PDCHs.

Some of the idle frames and PTCCH frames shall be used for this, while the others are required for BSIC identification and the timing advance procedure, see subclause 6.5.9.

The MS may not be capable of measuring all eight channels when allocated some configurations of channels. The MS shall measure as many channels as its allocation allows considering its multislot capability.

The slots that the MS measures on can be either idle or used by SACCH or PTCCH, depending on the channel type (TCH or PDCH).. The MS shall therefore, for each slot, take the minimum signal strength of one idle frame and one PTCCH frame. Thus the SACCH frames are avoided (except for a TCH/H with two MSs) and only the interference is measured.

The interference, γ_{CH} , is achieved by filtering the measured interference in a running average filter. The filter parameters are broadcast on PBCCH or, if PBCCH does not exist, on BCCH.

In packet transfer mode the MS shall transfer the 8 γ_{CH} values and the RXQUAL, SIGN_VAR and C values (see subclause 6.5.8.3.1) to the network in the Channel Quality Report included in the PACKET DOWNLINK ACK/NACK message.

6.5.8.4 Measurements at BSS side

A procedure shall be implemented in the BSS to monitor the uplink Rx signal level and quality on each uplink PDCH, active as well as inactive.

The BSS shall also measure the Rx signal level and the quality of a specific MS packet transfer.

6.5.9 Scheduling the MS activities during the PTCCH and idle frames

The MS shall use the PTCCH and idle frames of the PDCH multiframe for the following tasks:

- BSIC identification for cell re-selection (6.5.6.1)
- Continuous timing advance procedures (6.5.7.2)
- Interference measurements for power control (6.5.8.3.2)

It is not necessary to exactly specify the scheduling of these tasks.

The PTCCH frames used for timing advance signalling is stated in 6.5.7.2.1. During the frames when the MS receives TA-messages it can also make interference measurements. During the frames when the MS transmits access bursts it may also be possible to make measurements on some channels.

The MS shall schedule the BSIC identification as efficiently as possible, using the remaining PTCCH frames and the idle frames and also considering the requirements for interference measurements. When the MS is synchronised to a BTS, it knows the timing of the SCH. Therefore, only a few certain frames are required for BSIC identification. In those frames it may also be possible to make measurements on some channels. When the MS shall synchronise to a new BTS, it has to prioritise that task. It may then use half of the PTCCH and idle frames, i.e. the same amount as available for circuit switched connections.

The remaining PTCCH and idle frames shall be used for interference measurements.

6.5.10 Discontinuous Reception (DRX)

NOTE: The text in this subclause is informative. The normative text is in 3GPP TS 45.002 [11]. Where there is a conflict between these descriptions, the normative text has precedence.

DRX (sleep mode) shall be supported when the MS is in Packet Idle mode. DRX is independent from MM states Ready and Standby.

Negotiation of DRX parameters is per MS. An MS may choose to use DRX or not together with some operating parameters. The following parameters are established:

- **DRX/non-DRX indicator**
It indicates whether the MS uses DRX or not.
- **DRX period**
A conditional parameter for MSs using DRX to determine the right paging group. The DRX period is defined by the parameter SPLIT_PG_CYCLE.
- **Non-DRX timer**
A conditional parameter for MSs using DRX to determine the time period within which the non-DRX mode is kept after leaving the Transfer state. The support for this feature is optional on the network side and the information about the maximum supported value for the timer in the cell is broadcast on PBCCH.

An MS in DRX mode is only required to monitor the radio blocks defined by its paging group as defined in 3GPP TS 45.002 [11].

Paging group definition based on SPLIT_PG_CYCLE is optional on CCCH for both BTS and MS. If not supported, the definition based on BS_PA_MFRMS shall be used. The parameters used to define the paging group for GPRS are shown in the Table 5, together with the corresponding GSM parameters. BS_PCC_CHANS is the number of PDCHs containing PCCCH. For Compact, BS_PCC_CHANS is the number of radio frequency channels per cell carrying CPCCCHs including the radio frequency channel carrying the CPBCCCH.

An MS in non-DRX mode is required to monitor all the radio blocks where PCCCH or (for Compact) CPCCCH may be mapped on the PDCH defined by its paging group.

When page for circuit-switched services is conveyed on PPCH, it follows the same scheduling principles as the page for packet data. The same is valid for scheduling of resource assignments for downlink packet transfers for MSs in Ready State (i.e. where no paging is performed).

NOTE: Paging reorganisation may be supported in the same way as for circuit switched GSM.

Table 5: Parameters for DRX operation

Parameter	GPRS		Corresponding GSM parameters
	PCCCH	CCCH	CCCH
DRX period	SPLIT_PG_CYCLE	BS_PA_MFRMS *) SPLIT_PG_CYCLE **)	BS_PA_MFRMS
Blocks not available for PPCH or CPPCH per multiframe	BS_PAG_BLK_RES + BS_PBCCH_BLK	BS_AG_BLK_RES	BS_AG_BLK_RES
Number of physical channels containing paging; or for Compact, number of radio frequency channels per cell carrying CPCCCHs including the radio frequency channel carrying the CPBCCH.	BS_PCC_CHANS	BS_CC_CHANS	BS_CC_CHANS

*) Only when DRX period split is not supported.

***) Only when DRX period split is supported.

6.6 Medium Access Control and Radio Link Control Layer

The Medium Access Control (MAC) and Radio Link Control (RLC) layer operates above the Physical Link layer in the reference architecture. MAC/RLC layer messages and signalling procedures are defined in 3GPP TS 44.060 [7] and 3GPP TS 44.018 [6].

6.6.1 Layer Services

The MAC function defines the procedures that enable multiple MSs to share a common transmission medium, which may consist of several physical channels. The MAC function provides arbitration between multiple MSs attempting to transmit simultaneously and provides collision avoidance, detection and recovery procedures. The operations of the MAC function may allow a single MS to use several physical channels in parallel.

The RLC function defines the procedures for a bitmap selective retransmission of unsuccessfully delivered RLC Data Blocks.

The RCL/MAC function provides two modes of operation:

- unacknowledged operation; and
- acknowledged operation

The RLC/MAC function provides one additional mode of operation, used in the case of p-t-m transmission for MBMS:

- non-persistent operation.

6.6.2 Layer Functions

The GPRS MAC function is responsible for:

- Providing efficient multiplexing of data and control signalling on both uplink and downlink, the control of which resides on the Network side. On the downlink, multiplexing is controlled by a scheduling mechanism. On the uplink, multiplexing is controlled by medium allocation to individual users (e.g., in response to service request).

- For mobile originated channel access, contention resolution between channel access attempts, including collision detection and recovery.
- For mobile terminated channel access, scheduling of access attempts, including queuing of packet accesses.
- Priority handling.

The GPRS RLC function is responsible for:

- Interface primitives allowing the transfer of Logical Link Control layer PDUs (LLC-PDU) between the LLC layer and the MAC function.
- Segmentation and re-assembly of LLC-PDUs into RLC Data Blocks.
- Backward Error Correction (BEC) procedures enabling the selective retransmission of uncorrectable code words.
- Transmission of code words according to the channel conditions, i.e link adaptation.

NOTE: The Block Check Sequence for error detection is provided by the Physical Link Layer.

In EGPRS incremental redundancy (IR) mode, RLC function is also responsible for:

- Storing soft values of the erroneous RLC Data Blocks and combining them with the retransmitted RLC Data blocks.

6.6.3 Service Primitives

Table 6 lists the service primitives provided by the RLC/MAC layer to the upper layers:

Table 6: Service primitives provided by the RLC/MAC layer to the upper layers

Name	request	indication	response	confirm	comments
RLC/MAC-DATA	x	x			used for the transfer of upper layer PDUs. Acknowledged mode of operation in RLC is used (Note). The upper layer shall be able to request high transmission quality via a primitive parameter.
RLC/MAC-UNITDATA	x	x			used for the transfer of upper layer PDUs. Unacknowledged mode of operation in RLC is used (Note).
RLC/MAC-PTM_DATA	[?]	[?]	[?]	[?]	used for the transfer of upper layer PDUs over point-to-multipoint bearers. Non-persistent mode of operation in RLC is used.
RLC/MAC-STATUS		x			used to indicate that an error has occurred on the radio interface. The cause for the failure is indicated.
NOTE: The RLC/MAC layer in the network may decide to use a different RLC mode than requested by the upper layers, in any case for downlink TBFs and, for uplink TBFs, when both the mobile station and the network support multiple TBFs procedures.					

6.6.4 Model of Operation

Each PDCH is a shared medium between multiple MSs and the Network except in dual transfer mode, in which a PDCH may be dedicated to one MS. Direct communication is possible only between an MS and the network.

The GPRS radio interface consists of asymmetric and independent uplink and downlink channels. The downlink carries transmissions from the network to multiple MSs and does not require contention arbitration. The uplink is shared among multiple MSs and requires contention control procedures.

The allocation of radio resources by the PLMN and the use of these resources by the MSs can be broken down into two parts:

- The PLMN allocates radio resources for the GPRS (uplink and downlink) in a symmetric manner.
- The allocated uplink and downlink radio resources for point-to-point or point-to-multipoint services are used independently of each other. Dependent allocation of uplink and downlink shall be possible, in order to allow simple MSs to transfer data simultaneously in both directions. Allocation of several PDTCHs for one MS is possible.

The access to the GPRS uplink uses a Slotted-Aloha based reservation protocol.

The Network Protocol Data Units (N-PDU) are segmented into the Subnetwork Protocol Data Units (SN-PDU) by the Subnetwork Dependent Convergence (SNDC) protocol and SN-PDUs are encapsulated into one or several LLC frames. See 3GPP TS 23.060 [3] for information on SNDC and LLC. The details on SNDC can be found in 3GPP TS 44.065 [9] and the details on LLC can be found in 3GPP TS 44.064 [8]. LLC frames are segmented into RLC Data Blocks. At the RLC/MAC layer, a selective ARQ protocol (including block numbering) between the MS and the Network provides retransmission of erroneous RLC Data Blocks. When a complete LLC frame is successfully transferred across the RLC layer, it is forwarded to the LLC layer.

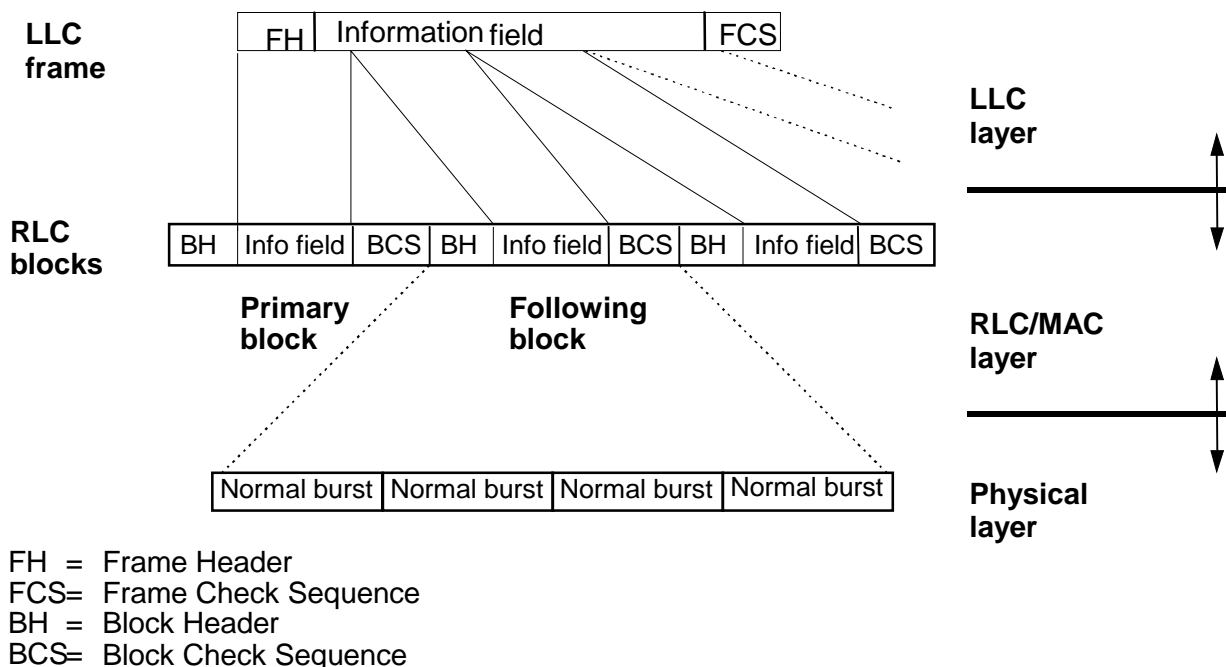

Figure 20: Transmission and reception data flow for GPRS and EGPRS

Transmission and reception data flows are same for GPRS and EGPRS, except for EGPRS MCS-9, MCS-8 and MCS-7, where four normal bursts carry two RLC blocks (one RLC block within two bursts for MCS-9 and MCS-8), as shown on Figures 21 and 22.

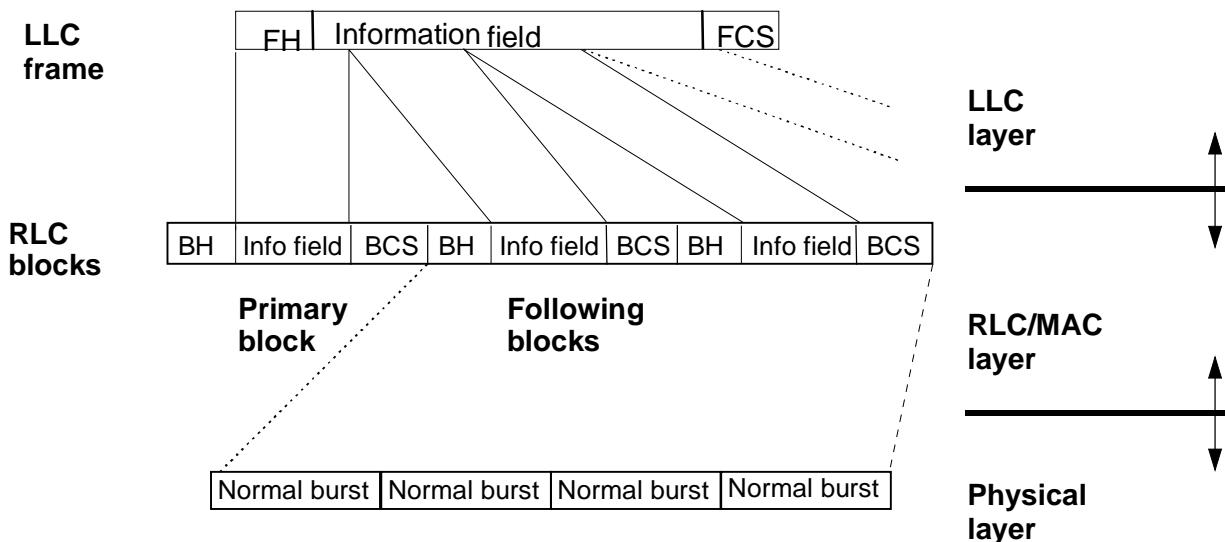

Figure 21: Transmission and reception data flow for EGPRS MCS-7

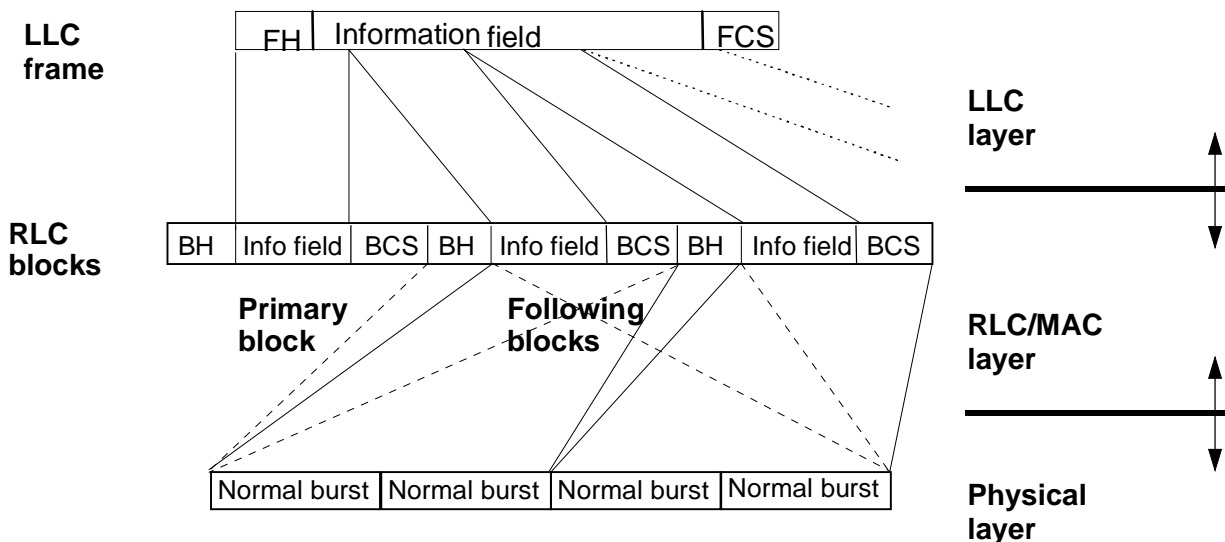

Figure 22: Transmission and reception data flow for EGPRS MCS-9 and MCS-8

6.6.4.1 Multiplexing MSs on the same PDCH

6.6.4.1.1 Uplink State Flag: Dynamic Allocation

6.6.4.1.1.1 Multiplexing of GPRS or EGPRS MSs

The Uplink State Flag (USF) is used on PDCH to allow multiplexing of Radio blocks from a number of MSs. USF is used in dynamic and extended dynamic medium access modes. USF is used only in downlink direction.

The USF comprises 3 bits at the beginning of each Radio Block that is sent on the downlink. It enables the coding of 8 different USF states which are used to multiplex the uplink traffic.

On PCCCH, one USF value is used to denote PRACH. The other USF values are used to reserve the uplink for different MSs. On PDCHs not carrying PCCCH, the eight USF values are used to reserve the uplink for different MSs. On a PDCH carrying MPRACH (whether it carries PCCCH or not), one USF value is used to denote MPRACH; this value is indicated by the network in the notification message (see 3GPP TS 44.060). One USF value shall be used to prevent collision on uplink channel, when MS without USF is using uplink channel. The USF points either to the next uplink Radio Block or the sequence of 4 uplink Radio Blocks starting with the next uplink Radio Block.

6.6.4.1.1.2 Multiplexing of GPRS and EGPRS MSs

The GPRS and EGPRS MSs can be multiplexed dynamically on the same PDCH by utilising the USF. When uplink resources are allocated to a GPRS mobile or an EGPRS mobile using a multislot allocation only compatible with its GPRS multislot class, the network must use GMSK, i.e. CS-1 to CS-4 or MCS-1 to MCS-4, and the USF must point to the sequence of four uplink Radio Blocks starting with the next uplink Radio Block.

The dynamic allocation using USF granularity requires that a GPRS MS can read the USF in an EGPRS GMSK block. This is enabled by setting the stealing bits in the EGPRS GMSK blocks to indicate CS-4. The coding and interleaving of the USF is done as defined for CS-4. This leads to:

1. A standard GPRS MS will be able to detect the USF in EGPRS GMSK blocks. The risk that the rest of the block will be misinterpreted as valid information is assumed to be low.
2. An EGPRS MS can not differentiate CS-4 blocks and EGPRS GMSK blocks by only looking at the stealing bits. This is however not needed for USF detection, since the USF is signalled in the same way. Further, assuming that the EGPRS MS knows if it is in EGPRS or standard GPRS mode, it will only have to try to decode the remainder of the GMSK blocks in one way in order to determine if they were aimed for it.

An EGPRS mobile station shall be able to decode the USF that assigns the uplink to that mobile station irrespective of the modulation and coding scheme, i.e. CS-1 to CS-4 or MCS-1 to MCS-9.

For mobile station synchronization reasons, if GPRS MSs or EGPRS mobiles using a multislot allocation only compatible with their GPRS multislot class are multiplexed on the PDCH, at least one downlink radio block every 360ms shall be transmitted to each MS with a coding scheme and a modulation that can be decoded by that MS.

6.6.4.1.2 Void

6.6.4.1.3 Exclusive Allocation

Exclusive allocation is used to reserve the uplink part of the PDCH for only one MS during the life of the Temporary Block Flow. In exclusive allocation, all the uplink blocks of the uplink part of the PDCH are available to the MS for transmission.

6.6.4.2 Temporary Block Flow

A Temporary Block Flow (TBF) is a physical connection used by the two RR entities to support the unidirectional transfer of LLC PDUs on packet data physical channels. The TBF is allocated radio resource on one or more PDCHs and comprise a number of RLC/MAC blocks carrying one or more LLC PDUs. A TBF is temporary and is maintained only for the duration of the data transfer.

6.6.4.3 Temporary Flow Identity

Each TBF is assigned a Temporary Flow Identity (TFI) by the network. The assigned TFI is unique among concurrent TBFs in each directions and is used instead of the MS identity in the RLC/MAC layer. The same TFI value may be used concurrently for TBFs in opposite directions. The TFI is assigned in a resource assignment message that precedes the transfer of LLC frames belonging to one TBF to/from the MS. The same TFI is included in every RLC header belonging to a particular TBF as well as in the control messages associated to the LLC frame transfer (e.g. acknowledgements) in order to address the peer RLC entities.

6.6.4.4 Medium Access modes

Four medium access modes are supported:

- Dynamic allocation,
- Extended Dynamic allocation, and
- Exclusive allocation.

The Dynamic allocation medium access mode shall be supported by all networks that support GPRS. The support of Extended Dynamic allocation and Exclusive allocation medium access modes is optional.

The Dynamic allocation shall be supported in all mobile stations. Exclusive allocation shall be supported in all mobile stations supporting DTM.

6.6.4.5 Acknowledged mode for RLC/MAC operation

6.6.4.5.1 GPRS

The transfer of RLC Data Blocks in the acknowledged RLC/MAC mode is controlled by a selective ARQ mechanism coupled with the numbering of the RLC Data Blocks within one Temporary Block Flow. The sending side (the MS or the network) transmits blocks within a window and the receiving side sends Packet Uplink Ack/Nack or Packet Downlink Ack/Nack message when needed. Every such message acknowledges all correctly received RLC Data Blocks up to an indicated block sequence number (BSN), thus "moving" the beginning of the sending window on the sending side. Additionally, the bitmap that starts at the same RLC Data Block is used to selectively request erroneously received RLC Data Blocks for retransmission. The sending side then retransmits the erroneous RLC Data Blocks, eventually resulting in further sliding the sending window.

The Packet Ack/Nack message does not include any change in the current assignment (and thus does not have to be acknowledged when sent on downlink). A missing Packet Ack/Nack is not critical and a new one can be issued whenever. In Packet Downlink Ack/Nack message, the MS may optionally initiate an uplink TBF.

When receiving uplink data from a MS the network shall, based on erroneous blocks received from MS, allocate additional resources for retransmission.

The acknowledgement procedure of the LLC layer is not combined with the acknowledgement procedure on the underlying RLC/MAC layer.

6.6.4.5.2 EGPRS

The transfer of RLC Data Blocks in the acknowledged RLC/MAC mode can be controlled by a selective type I ARQ mechanism, or by type II hybrid ARQ (incremental redundancy: IR) mechanism, coupled with the numbering of the RLC Data Blocks within one Temporary Block Flow. The sending side (the MS or the network) transmits blocks within a window and the receiving side sends Packet Uplink Ack/Nack or Packet Downlink Ack/Nack message when needed.

According to the link quality, an initial MCS is selected for an RLC block. For the retransmissions, the same or another MCS from the same family of MCSs can be selected. E.g. if MCS-7 is selected for the first transmission of an RLC block, any MCS of the family B can be used for the retransmissions. The selection of MCS is controlled by the network.

In the EGPRS type II Hybrid ARQ scheme, the information is first sent with one of the initial code rates (i.e., the rate 1/3 encoded data is punctured with the puncturing scheme (PS) 1 of the selected MCS). If the RLC Data Block is received in error, additional coded bits (i.e., the output of the rate 1/3 encoded data which is punctured with PS 2 of the prevailing MCS) are sent and decoded together with the already received codewords until decoding succeeds. If all the codewords (different punctured versions of the encoded data block) have been sent, the first codeword (which is punctured with PS 1) is sent. Alternatively, it is possible to use incremental redundancy modes called MCS-5-7 and MCS-6-9, in which the initial transmissions are sent with either MCS-5 or MCS-6 (respectively) and the retransmissions are sent with MCS-7 or MCS-9 (respectively). Header part is robustly coded so that the receiver is able to determine the block identities for all transmissions, even if the payload cannot be decoded.

In the EGPRS type I ARQ, the operation is similar to the one of the EGPRS type II hybrid ARQ, except that the decoding of an RLC Data Block is solely based on the prevailing transmission (i.e., erroneous blocks are not stored).

Type II hybrid ARQ is mandatory in EGPRS MS receivers and the associated performance requirements are specified in 3GPP TS 45.005 [14].

6.6.4.6 Unacknowledged mode for RLC/MAC operation

The transfer of RLC Data Blocks in the unacknowledged RLC/MAC mode is controlled by the numbering of the RLC Data Blocks within one Temporary Block Flow and does not include any retransmissions. The receiving side extracts user data from the received RLC Data Blocks and attempts to preserve the user information length by replacing missing RLC Data Blocks by dummy information bits.

The same mechanism and message format for sending temporary acknowledgement messages is used as for acknowledged mode in order to convey the necessary control signalling (e.g. monitoring of channel quality for

downlink channel or timing advance correction for uplink transfers). The fields for denoting the erroneous RLC blocks may be used as an additional measure for channel quality (i.e. parameter for link adaptation). The sending side (the MS or the network) transmits a number of radio blocks and then polls the receiving side to send an acknowledgement message. The Packet Uplink Ack/Nack and Packet Downlink Ack/Nack message does not include any change in the current assignment. A missing acknowledgement message is not critical and a new one can be obtained whenever. In Packet Downlink Ack/Nack message, the MS may optionally initiate an uplink TBF.

6.6.4.6a Non-persistent mode for RLC/MAC operation

The non-persistent RLC/MAC mode is used only for the transmission of RLC data blocks over an MBMS bearer.

A description of the network and mobile station behaviour for this mode of RLC/MAC operation can be found in 3GPP TS 43.246.

6.6.4.7 Mobile Originated Packet Transfer

6.6.4.7.1 Uplink Access

6.6.4.7.1.1 On the (P)RACH

This sub-clause applies to all mobile stations in packet idle mode. It also applies to class A mobiles stations in dedicated mode if they are not DTM capable.

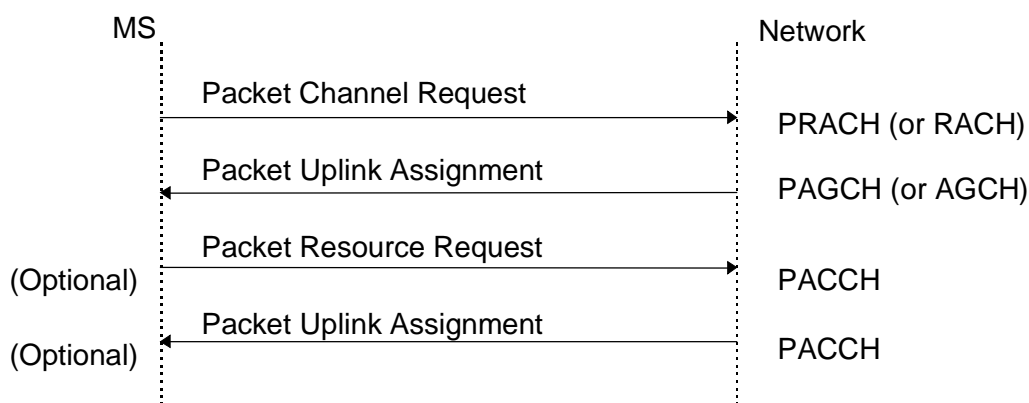

Figure 23: Access and allocation for the one or two phase packet access, uplink packet transfer

An MS initiates a packet transfer by making a Packet Channel Request on PRACH or RACH. The network responds on PAGCH or AGCH respectively. It is possible to use one or two phase packet access method (see Figure 23).

In the one phase access, the Packet Channel Request is responded by the network with the Packet Uplink Assignment reserving the resources on PDCH(s) for uplink transfer of a number of Radio blocks. The reservation is done accordingly to the information about the requested resources that is comprised in the Packet Channel Request. On RACH, there is only two cause values available for denoting GPRS, which can be used to request limited resources or two phase access. On PRACH, the Packet Channel Request may contain more adequate information about the requested resources and, consequently, uplink resources on one or several PDCHs can be assigned by using the Packet Uplink Assignment message.

In the two phase access, the Packet Channel Request is responded with the Packet Uplink Assignment which reserves the uplink resources for transmitting the Packet Resource Request. A two phase access can be initiated by the network or a mobile station. The network can order the MS to send Packet Resource Request message by setting parameter in Packet Uplink Assignment message. Mobile station can request two phase access in Packet Channel Request message. In this case, the network orders MS to send Packet Resource Request message.

The Packet Resource Request message carries the complete description of the requested resources for the uplink transfer. The MS can indicate the medium access method, it prefers to be used during the TBF. The network responds with the Packet Uplink Assignment reserving resources for the uplink transfer and defining the actual parameters for data transfer (e.g. medium access mode).

When the network supports multiple TBF procedures a mobile station that supports multiple TBF procedures may request multiple uplink TBFs by sending a Packet Resource Request message during a two-phase access. In this case the Packet Resource Request message carries the PFI and channel request description for each requested uplink TBF. The network may respond with one or more instances of a MULTIPLE TBF UPLINK ASSIGNMENT message. These assignment messages always include an indication of the PFI associated with each uplink TBF for which resources are being allocated.

If there is no response to the Packet Channel Request within predefined time period, the MS makes a retry after a random backoff time.

On PRACH there is used a 2-step approach including a long-term and a short-term estimation of the persistence (see Figure 24). The optimal persistence of the mobile stations is calculated at the network side.

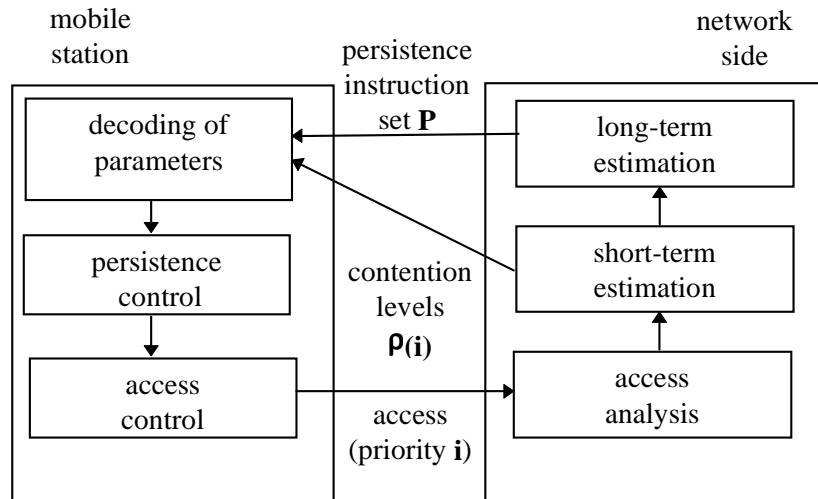

Figure 24a: Basic principle of random access traffic control

The actual persistence values depend on:

- the priority i of the packet to be transmitted;
- the amount of traffic within higher priority classes;
- the amount of traffic within the own priority class.

Optionally, the existing backoff algorithm on RACH can be used on PRACH.

On RACH, the existing backoff algorithm shall be used.

Occasionally, more Packet Channel Requests can be received than can be served. To handle this, a Packet Queuing Notification is transmitted to the sender of the Packet Channel Request. The notification includes information that the Packet Channel Request message is correctly received and Packet Uplink Assignment may be transmitted later. If the Timing Advance information becomes inaccurate for an MS, the network can send Packet Polling Request to trigger the MS to send four random access bursts. This can be used to estimate the new Timing Advance before issuing the Packet Uplink Assignment.

6.6.4.7.1.2 On the main DCCH

This clause only applies to mobile stations in dedicated mode that support DTM. This procedure moves the mobile station from dedicated mode to dual transfer mode.

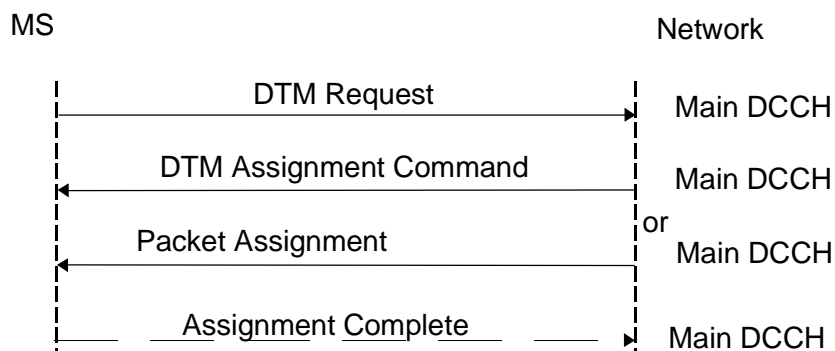

Figure 24b: Access and allocation for the packet request procedure, uplink packet transfer

A DTM mobile station initiates a packet transfer while in dedicated mode by sending a DTM Request message on the main DCCH.

The DTM Request message carries a description of the requested resources for the uplink transfer and shall only be used to request one uplink TBF. The DTM Request message is responded by the network with one of the following DTM assignment messages:

- DTM Assignment Command: sent when the network allocates a TBF and reallocation of the resource of the RR connection is needed.
- Packet Assignment: sent when the network allocates a TBF and no reallocation of the resource of the RR connection is needed.

The DTM Assignment Command may be sent during DTM if the mobile station and network support multiple TBF procedures, reallocation of a combination of one or more ongoing uplink and downlink TBFs is needed and the resource of the RR connection is needed (i.e. the DTM Assignment Command shall not be used to provide resource allocations for new uplink TBFs when there are ongoing TBFs). In this case, any ongoing TBFs not addressed by the DTM Assignment Command are released.

If there is reallocation of the resource of the RR connection (through a DTM Assignment Command message), the MS sends an Assignment Complete message on the new main DCCH after it is established.

When a mobile station that supports multiple TBF procedures has entered dual transfer mode as described above where an uplink TBF is operating in exclusive allocation mode then no additional uplink TBFs may be established. If exclusive allocation is not used in dual transfer mode the mobile station may request one or more additional uplink TBFs by sending a Packet Resource Request message on the PACCH:

- The Packet Resource Request message carries the PFI and channel request description for each requested uplink TBF.
- The network may respond with a Packet Uplink Assignment message, a Multiple TBF Uplink Assignment message or a Multiple TBF Timeslot Reconfigure message reserving resources for the requested uplink data transfers and defining the actual parameters for each uplink data transfer (e.g. medium access mode).

If the uplink TBFs requested in the Packet Resource Request require re-allocation of the RR connection then the network sends a DTM Assignment Command which re-allocates the RR connection and a combination of one or more ongoing uplink and downlink TBFs (i.e. any ongoing TBFs not addressed by the DTM Assignment Command are released). Any outstanding uplink TBF requests received on the old resources will be responded to by the network on the newly allocated resources.

6.6.4.7.2 Dynamic/Extended Dynamic allocation

6.6.4.7.2.1 Uplink Packet Transfer

The Packet Uplink Assignment, the Multiple TBF Uplink Assignment, Packet Timeslot Reconfigure and the Multiple TBF Timeslot Reconfigure messages include the list of PDCHs and the corresponding USF value per PDCH for each uplink TBF they allocate resources for. A unique TFI is allocated and is thereafter included in each RLC Data and Control Block related to that Temporary Block Flow. The MS monitors the USFs on the downlink PDCHs corresponding to (i.e. with the same timeslot number as) the uplink PDCHs allocated for each TBF and transmits Radio blocks on those PDCHs which currently bear the USF value reserved for the usage of the MS on each TBF.

If the resource assigned by the network in the case of extended dynamic allocation does not allow the multislot MS (see 3GPP TS 45.002 [11]) to monitor the USF on all the assigned PDCHs, the following rules shall apply:

- Whenever the MS receives its USF on one downlink PDCH (e.g. on timeslot 0 while timeslots 0, 2 and 3 were assigned), it shall consider the corresponding uplink block and all subsequent ones from the list of assigned PDCHs as allocated (e.g. on 0, 2 and 3). Hence, if the network allocates a block to this MS on an assigned PDCH, it shall also allocate blocks to this MS on all subsequent PDCHs in the list. For each allocated block, the network shall set the USF to the value reserved for the usage of that MS. These rules apply on a block period basis.
- During block periods where it is transmitting, the MS shall monitor the USF on each downlink PDCH in the list of PDCHs corresponding to the assigned uplink PDCHs, up to and including the last PDCH that the MS is capable of receiving, according to the current uplink timeslot allocation and the switching requirements of its multislot class (see 3GPP TS 45.002 [11]). This rule applies on a block period basis. For example, if timeslots 0, 2 and 3 have been assigned and blocks are currently allocated on timeslots 2 and 3, then during this block period a MS for which $T_{ta}=1$ or $T_{tb}=1$ monitors USF on timeslots 0, 2 and 3. If the reserved value of USF is found on timeslot 0, then the next allocated blocks shall be on timeslots 0, 2 and 3 (thus increasing the timeslot allocation); if the reserved value of USF is found on timeslot 2, then the next allocated blocks shall be on timeslots 2 and 3 (thus maintaining the timeslot allocation unchanged); if the reserved value of USF is found on timeslot 3, then the next allocated block shall be on timeslot 3 (thus reducing the timeslot allocation by one timeslot). And so on for the subsequent block periods. MSs for which $T_{ta}>1$ or $T_{tb}>1$ are unable to monitor the USF on timeslot 3; for these MSs, in order to reduce the timeslot allocation, the network needs to leave at least one block period with no blocks allocated to the MS. Because each Radio Block includes an identifier (TFI), all received Radio blocks are correctly associated with a particular LLC frame and a particular MS, thus making the protocol highly robust. By altering the state of USF, different PDCHs can be "opened" and "closed" dynamically for certain MSs thus providing a flexible reservation mechanism. Additionally, packets with higher priority and pending control messages can temporarily interrupt a data transmission from one MS.
- In the case of dual transfer mode, if the mobile station supports DTM high multislot class capability, the network may assign uplink PDCHs whose corresponding downlink PDCH can never be monitored by the mobile station because of the presence of the uplink dedicated channel. In this case, the mobile station shall monitor only those downlink PDCHs that are feasible when taking into account the position of the uplink dedicated channel and the switching requirements of its multislot class (see 3GPP TS 45.002 [11]).

The channel reservation algorithm can also be implemented on assignment basis. This allows individual MSs to transmit a predetermined amount of time without interruptions.

The MS may be allowed to use the uplink resources as long as there is queued data on the RLC/MAC layer to be sent from the MS. It can comprise a number of LLC frames. In that sense the radio resources are assigned on the initially "unlimited" time basis. Alternatively, the uplink assignment for each assignment may be limited to a number of radio blocks (e.g. in order to offer more fair access to the medium at higher loads).

The selective ARQ operation for the acknowledged RLC/MAC mode is described in Subclause 6.6.4.5. The unacknowledged RLC/MAC mode operation is described in Subclause 6.6.4.6.

Figure 25 shows an example of message sequence for the (multislot) uplink data transfer with one resource reallocation and possible RLC Data Block re-transmissions.

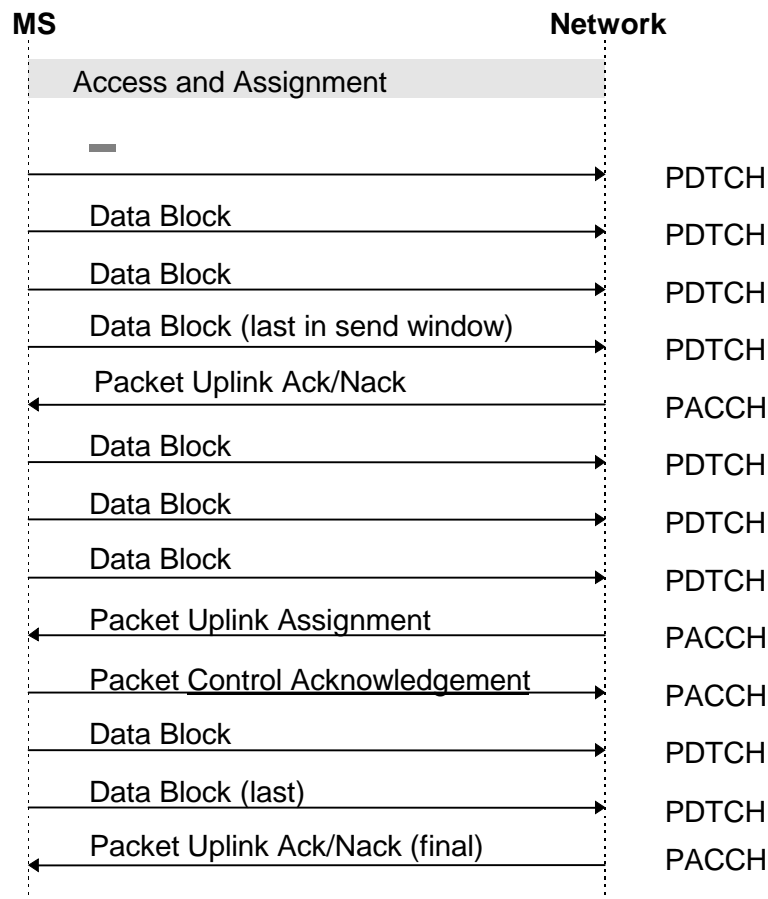

Figure 25: An example of dynamic allocation uplink data transfer

6.6.4.7.2.2 Release of the Resources

The release of the resources allocated for a TBF is normally initiated from the MS by counting down the last couple of blocks sent for that TBF.

For the normal release of resources for RLC connection carrying a mobile originated packet transfer, the mechanism based on acknowledged final Packet Uplink Ack/Nack combined with timers is used.

After the MS has sent its last RLC Data Block (indicated by the countdown field), the acknowledgement is expected from the network side. By sending the last block, the MS may no longer use the same assignment unless a negative acknowledgement arrives. It also means that the network side may reallocate the same USF(s) to some other user as soon as all the RLC Data Blocks belonging to that Temporary Block Flow are correctly received; that regardless of the possible later errors in the acknowledgements.

The next step, in the case of all RLC Data Blocks being correctly received, is that the network sends Packet Uplink Ack/Nack which is to be immediately acknowledged by the MS in the reserved uplink block period. It must be possible for the network not to use the mechanism of acknowledgement for Packet Ack/Nack in which case the release of the resources procedure relies only on timers. The TFI can be reused for another assignment either upon the reception of the acknowledgement for Packet Ack/Nack or after expiry of the guard timer.

Further, the premature release or change of assignment for one MS may be initiated:

- by the network with an explicit message
- in dual transfer mode, by the release of the RR connection (i.e. handover, assignment and channel release procedures) or
- by the establishment of an RR connection.

In the case of release, the MS is ordered to interrupt the Temporary Block Flow for the TBF being released. The MS shall then reorganise the uplink buffer and issue a new Packet Channel Request to continue the uplink transfer with the RLC Data Blocks containing untransferred (i.e. on the RLC/MAC layer unacknowledged) LLC frames.

A change in assignment may also be initiated by the network, in which case the Packet Uplink Assignment, Packet Timeslot Reconfigure, Multiple TBF Uplink Assignment, Multiple TBF Timeslot Reconfigure, DTM Assignment Command or Packet Assignment message is issued.

6.6.4.7.3 Void

6.6.4.7.4 Exclusive Allocation

Exclusive allocation uses the Packet Uplink Assignment, Packet Timeslot Reconfigure, DTM Assignment Command or Packet Assignment messages to communicate a exclusive uplink resource allocation to the MS. The exclusive allocation consists of a start frame and a slot assignment. The MS waits until the start frame indicated and then starts transmitting the radio blocks. The exclusive allocation includes neither the USF nor the block assignment bitmap. The MS is free to transmit on the uplink without monitoring the downlink for the USF. Unused USF values may be used to prevent other mobiles from transmitting. A unique TFI is allocated and is thereafter included in each RLC data and downlink control block related to that Temporary Block Flow. Because each Radio Block includes an identifier (TFI or TLLI), all received Radio blocks are correctly associated with a particular LLC frame and a particular MS.

When a mobile station that supports multiple TBF procedures is in dual transfer mode where exclusive allocation is used, only one uplink TBF can be established. If exclusive allocation is not used in dual transfer mode then a mobile station that supports multiple TBF procedures may request the establishment of multiple uplink TBFs (i.e. in this case the mobile station must support a DTM multislot class that allows for more than one uplink timeslot). In this case the mobile station shall always indicate the PFI associated with each uplink TBF that it requests and all uplink TBFs shall operate using dynamic allocation or extended dynamic allocation.

The selective ARQ operation for the acknowledged RLC/MAC mode is described in Subclause 6.6.4.5. The unacknowledged RLC/MAC mode operation is described in Subclause 6.6.4.6.

Figure 25 shows an example of message sequence for the (multislot) uplink data transfer with one resource reallocation and possible RLC Data Block re-transmissions.

6.6.4.7.5 Contention Resolution

Contention resolution is an important part of RLC/MAC protocol operation, especially because one channel allocation can be used to transfer a number of LLC frames. Contention resolution does not apply to the packet request procedures while in dedicated mode for an MS supporting DTM.

There are two basic access possibilities, one phase and two phase access as defined in Subclause 6.6.4.7.1.

The two phase access is inherently immune for possibility that two MSs can perceive the same channel allocation as their own. Namely the second access phase, the Packet Resource Request, uniquely identifies the MS by its TLLI. The same TLLI is included in the Packet Uplink Assignment/Packet Downlink Assignment and no mistake is possible.

The one phase access is somewhat insecure and an efficient contention resolution mechanism has to be introduced.

The first part of the solution is the identification of the MS. The identification of transmitting MS on the RLC/MAC level is necessary not only for contention resolution but also to be able to establish RLC protocol entity for that Temporary Block Flow on the network side. Additionally, the TLLI is necessary to be able to match simultaneous uplink and downlink packet transfers by taking into consideration multislot capability of that MS.

In order to uniquely identify the MS when sending on uplink, the RLC Header for all the RLC Data Blocks on uplink is extended to include the TLLI until the contention resolution is completed on the MS side.

The second part of the solution is the notification from the network side about who owns the allocation. That is solved by the inclusion of the TLLI in the Packet Uplink Ack/Nack/Packet Downlink Ack/Nack. This message shall be sent in an early stage, even before the receive window for RLC/MAC protocol operation is full. By doing so, the contention is resolved after the first occurrence of Packet Ack/Nack. The possibility of RLC Data Blocks being captured from 'wrong' MS, thus destroying the LLC frame, shall be covered for by retransmissions on the LLC layer.

6.6.4.8 Mobile Terminated Packet Transfer

6.6.4.8.1 Packet Paging

The network initiates a packet transfer to an MS that is in the Standby state by sending one or more packet paging request messages on the downlink PPCH or PCH. The MS responds to one packet paging request message by initiating a mobile originated packet transfer, as described in section 6.6.4.7. This mobile originated packet transfer allows the MS to send a packet paging response to the network. The packet paging response is one or more RLC/MAC data blocks containing an arbitrary LLC frame. The message sequence described in Figure 26 below is conveyed either on PCCCH or on CCCH. After the packet paging response is sent by the MS and received by the network, the mobility management state of the MS is Ready.

The network can then assign some radio resources to the MS and perform the downlink data transfer as described in section 6.6.4.8.2.

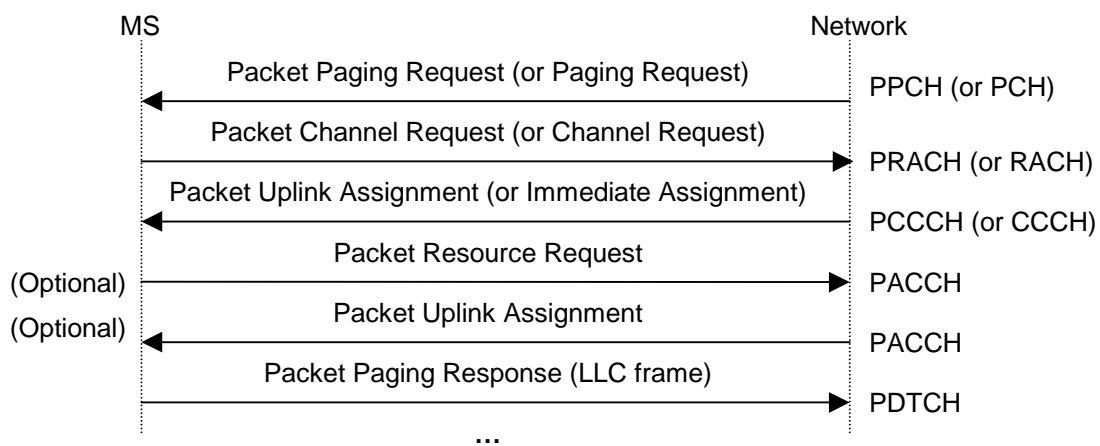

Figure 26: Paging message sequence for Paging, downlink packet transfer

6.6.4.8.2 Downlink Packet Transfer

The transmission of a packet to an MS in the Ready state is initiated by the network using a packet downlink assignment message. In case there is an uplink packet transfer in progress, the packet downlink assignment message (Packet Downlink Assignment, Multiple TBF Downlink Assignment, Packet Timeslot Reconfigure or a Multiple TBF Timeslot Reconfigure) is transmitted on PACCH. Else, in case there is no uplink or downlink transfer in progress and if there is a PCCCH allocated in the cell, the Packet Downlink Assignment or Multiple TBF Uplink Assignment message is transmitted on PCCCH. If there is no PCCCH allocated in the cell the Immediate Assignment message is transmitted on CCCH. For a DTM MS in dedicated mode, the assignment message is transmitted on the main DCCH. The packet downlink assignment messages include the list of PDCH(s) that will be used for downlink transfer. The Timing Advance and Power Control information is also included, if available. Otherwise, the MS may be requested to respond with a Packet Control Acknowledgement (see also Subclause 6.5.7 on timing advance procedures). The MS multislot capability needs to be considered.

The network sends the RLC/MAC blocks belonging to one Temporary Block Flow on downlink on the assigned downlink channels.

Multiplexing the RLC/MAC blocks destined for different MSs on the same PDCH downlink is enabled with an identifier, e.g. TFI, included in each RLC/MAC block. The interruption of data transmission to one MS is possible.

The acknowledged (i.e. selective ARQ operation) RLC/MAC mode operation is described in subclause 6.6.4.5; the unacknowledged RLC/MAC mode operation is described in subclause 6.6.4.6; the non-persistent RLC/MAC mode operation is described in subclause 6.6.4.6a. The sending of the Packet Downlink Ack/Nack message is obtained by the occasional network initiated polling of the MS. The MS sends the Packet Downlink Ack/Nack message in a reserved radio block which is allocated together with polling. Unassigned USF value is used in the downlink radio block which

corresponds to the reserved uplink radio blocks. Further, if the MS wants to send some additional signalling or uplink data, it may be indicated in the Packet Downlink Ack/Nack message.

Figure 27 shows an example of message sequence for (multislot) downlink data transfer with one resource reallocation and possible RLC Data Block re-transmissions.

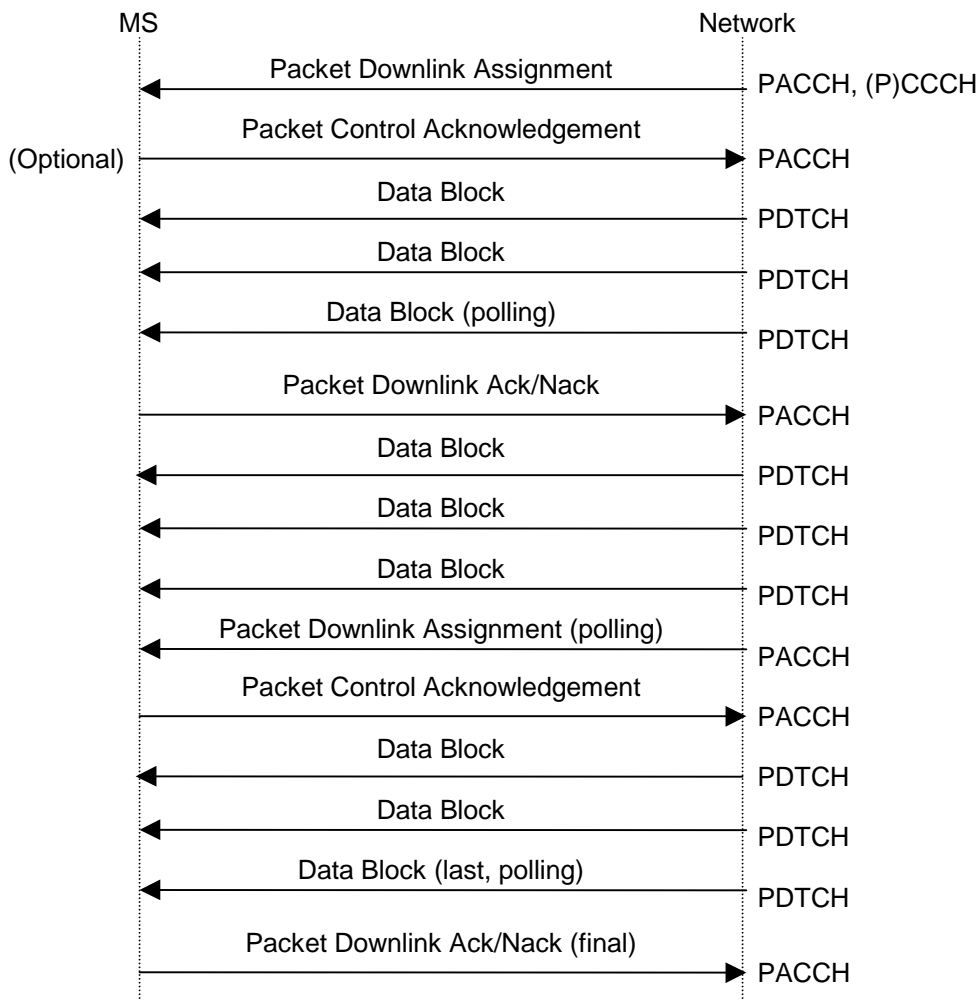

Figure 27: An example of downlink data transfer

Figure 28 shows an example of a message sequence for allocating two downlink TBFs to a mobile station that supports multiple TBF procedures (and multislot) with possible RLC Data Block re-transmissions.

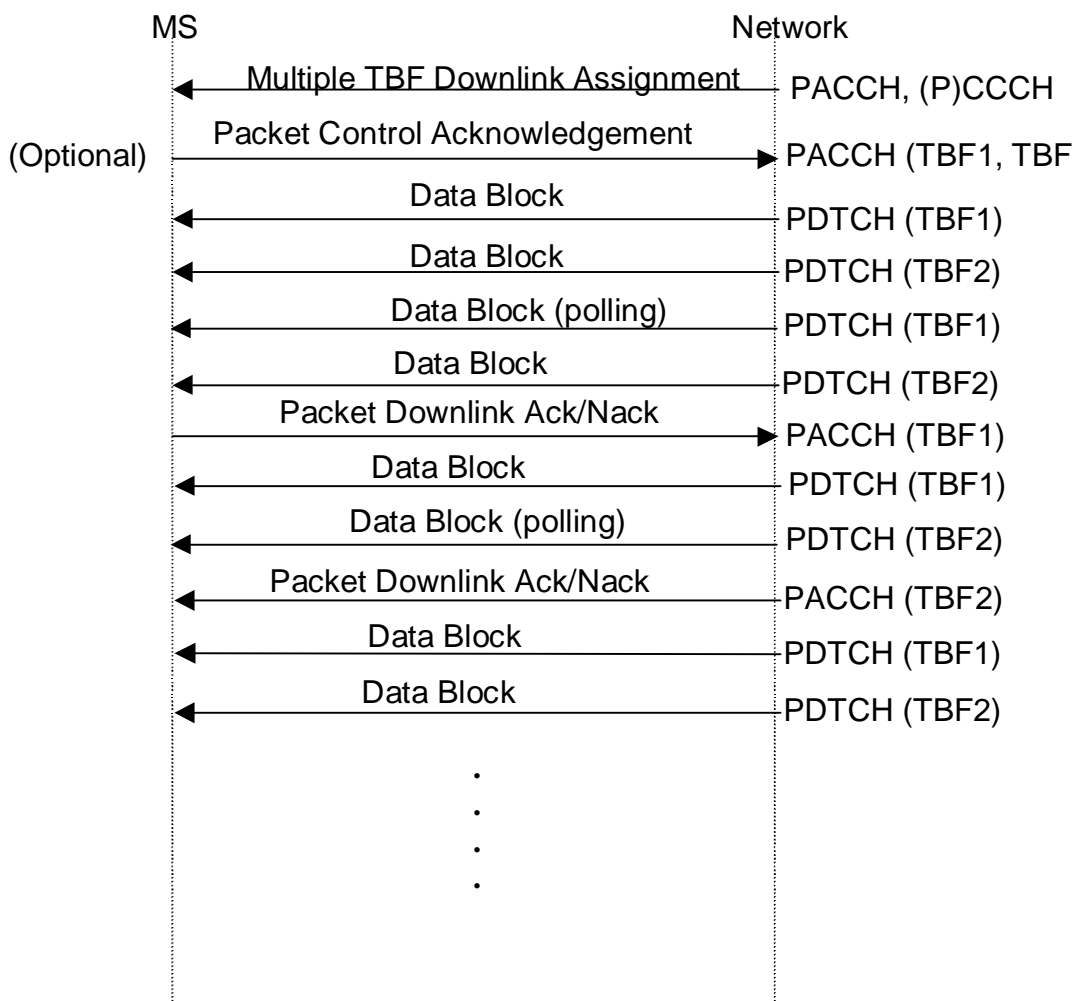

Figure 28: An example of downlink data transfer with two TBFs

6.6.4.8.3 Release of the Resources

The release of the resources is initiated by the network by terminating the downlink transfer and polling the MS for a final Packet Downlink Ack/Nack message.

A mobile station in dual transfer mode shall abandon the packet resources when the RR connection is released.

It is possible for the network to change the current downlink assignment by using the Packet Downlink Assignment, Packet Timeslot Reconfigure, Multiple TBF Downlink Assignment or Multiple TBF Timeslot Reconfigure message, which then has to be acknowledged by the MS in a reserved radio block on the uplink.

The handling of TFI is steered with the same timer that runs on both the MS and the network side after the last RLC Data Block is sent to the MS. When it expires, the current assignment becomes invalid for the MS and TFI can be reused by the network. Further, upon the reception of the final Packet Downlink Ack/Nack from the MS, another timer is started on network side. When it expires, the current assignment becomes invalid for the MS and TFI can be reused by the network.

6.6.4.8.4 Packet Paging Notification

The network initiates a packet transfer to a DTM MS that is in the Standby state and in dedicated mode by sending one or more packet paging notification messages on the downlink main DCCH. The MS responds to one packet paging notification message by initiating a mobile originated packet request, as described in section 6.6.4.7. This mobile originated packet transfer allows the MS to send a packet paging response to the network. The packet paging response

is one or more RLC/MAC data blocks containing an arbitrary LLC frame. After the packet paging response is sent by the MS and received by the network, the mobility management state of the MS is Ready.

The network can then assign some radio resources to the MS and perform the downlink data transfer as described in section 6.6.4.8.2.

6.6.4.9 Simultaneous Uplink and Downlink Packet Transfer

6.6.4.9.1 MS Does Not Support Multiple TBF Procedures

During the ongoing uplink Temporary Block Flow, the MS continuously monitors one downlink PDCH for possible occurrences of Packet Downlink Assignment or Packet Timeslot Reconfigure messages on PACCH (see Figure 25). The MS is therefore reachable for downlink packet transfers that can then be conveyed simultaneously on the PDCH(s) that respect the MS multislot capability.

If the MS wants to send packets to the network during the ongoing downlink Temporary Block Flow, it can be indicated in the acknowledgement that is sent from the MS. By doing so, no explicit Packet Channel Requests have to be sent to the network. Further, the network already has the knowledge of which PDCH(s) that particular MS is currently using so that the uplink resources can be assigned on the PDCH(s) that respect the MS multislot capability. This method may introduce an extra delay when initiating the uplink packet transfer but only for the first LLC frame in a sequence.

6.6.4.9.2 MS Supports Multiple TBF Procedures

Mobile station support of multiple TBF procedures is optional. A mobile station that supports multiple TBF procedures may operate multiple uplink and downlink TBFs concurrently. The maximum number of TBFs that a mobile station that supports multiple TBF procedures can support concurrently is not specified. Mobile station implementations are expected to ensure that the mobile station can support the number of TBFs sufficient to operate all the PDP contexts it has activated. As such, a mobile station may choose to release, modify or activate one or more PDP contexts when prioritizing the services it wants to operate concurrently. The network is not required to consider any potential complexity limitations regarding the number of concurrent TBFs when establishing an uplink or downlink TBF for a mobile station that supports multiple TBF procedures.

When any given PDP Context is activated, it is allocated a Packet Flow Context by the network and the payload associated with the corresponding PFI will be sent using one TBF (for a unidirectional service) or one uplink and one downlink TBF (for a bidirectional service). As such, each activated PDP Context has an implicit number of TBFs required to support it. However, the total number of TBFs required to support a given set of active PDP Contexts associated with a mobile station that supports multiple TBF procedures may be reduced as a result of TBF sharing as follows:

- Any given PDP Context that a mobile station attempts to activate for a unidirectional service may be aggregated by the SGSN so that the same PFI is associated with multiple PDP Contexts (see clause 12.6.3.5 of 3GPP TS 23.060). When this occurs a single TBF is used to deliver user plane payload associated with any of the aggregated PDP Contexts.
- Bandwidth from a TBF allocated to send user plane payload for an active PDP Context is stolen to send control plane messages (e.g. GMM or SM).

Network support of packet flow context (PFC) procedures is indicated by the PFC_FEATURE_MODE parameter that is broadcast on either the BCCH or PBCCH. If the PFC_FEATURE_MODE bit is not present then the network does not support PFC procedures or multiple TBF procedures. If the network supports PFC procedures then a mobile station may indicate a PFI value during uplink TBF establishment.

Network support of multiple TBF procedures is indicated using the MTBF_CAPABILITY parameter that is broadcast on either the BCCH and PBCCH. If the network indicates it supports multiple TBF procedures then it shall also indicate support for PFC procedures. When the network and the mobile station both support multiple TBF procedures then the mobile station shall indicate the PFI value associated with each uplink TBF it attempts to establish

During one or more ongoing TBFs, the mobile station continuously monitors its allocated downlink PDCHs for possible occurrences of downlink TBF allocations from the network. The network has knowledge of which uplink PDCH(s) the mobile station is already using and can therefore allocate downlink PDCH(s) that respect the multislot capability of the MS.

During one or more ongoing TBFs, a mobile station can request the establishment of one or more uplink TBFs by sending a Packet Downlink Ack/Nack or a Packet Resource Request message to the network. The network has knowledge of which downlink PDCH(s) the mobile station is already using and can therefore allocate uplink PDCH(s) that respect the multislot capability of the MS. Using a Packet Downlink Ack/Nack to make an uplink TBF request may introduce an extra delay when initiating the corresponding uplink packet transfer(s) but only for the first LLC frame in a sequence.

6.7 Abnormal cases in GPRS MS Ready State

The RLC/MAC error causes and procedures to handle these can be found in 3GPP TS 44.008 [6], 3GPP TS 44.060 [7] and 3GPP TS 45.008 [15].

6.8 Void

6.9 MBMS Data Transfer

MBMS data, in the form of individual upper layer frames, is mapped into RLC/MAC-PTM_DATA primitive and distributed from SGSN to the BSS representing the cells that belong to the Service Area. In the case of *A/Gb mode*, upper layer frames are LLC frames.

The procedures for notification, user counting and addressing, channel assignment and data transfer are specified in 3GPP TS 43.246.

Annex A (informative): Bibliography

- 1) ITU-T I.130, Method for the Characterization of Telecommunication Services Supported by an ISDN
- 2) ITU-T Q.65, Stage 2 of the Method for Characterization of the Services Supported by an ISDN
- 3) DIS 8886, OSI Data Link Service Definition
- 4) DIS 10022, OSI Physical Service Definition
- 5) ISO 10039, Medium Access Control Service Definition
- 6) ISO 4335, HDLC Procedures
- 7) ISO 7478, Multilink Procedures
- 8) ISO 7498, OSI Basic Reference Model and Layer Service Conventions

Annex B (informative): Multiple TBF Feature

B.1 General

The multiple TBF feature has been optionally introduced for mobile stations and networks operating in A/Gb mode, this feature is described in TS 43.064 and TS 44.060, and in TS 43.055 and TS 44.018 for DTM procedures.

A mobile station that supports multiple TBF procedures may operate multiple uplink and downlink TBFs concurrently. The maximum number of TBFs that a mobile station can support in either direction concurrently is not specified.

In order to support multiple TBFs, both the network and the mobile station must support:

- i) Packet flow procedures. The PFI (packet flow identifier) is used in the equivalent manner to the RB Id (radio bearer identifier in *Iu mode*) in RLC/MAC control messages
- ii) Multiple TBF assignment messages (i.e. MULTIPLE TBF UPLINK ASSIGNMENT, MULTIPLE TBF DOWNLINK ASSIGNMENT and MULTIPLE TBF TIMESLOT RECONFIGURE messages)

There are no minimum multislot class requirements defined in relation to the support of the multiple TBF feature.

Mobile station implementations are expected to ensure that the mobile station can support the number of TBFs sufficient to operate all the PDP contexts it has activated. As such, a mobile station may choose to release, modify or activate one or more PDP contexts when prioritising the services it wants to operate concurrently. The network is not required to consider any potential complexity limitations regarding the number of concurrent TBFs when establishing an uplink or downlink TBF for a mobile station that supports multiple TBF procedures.

B.2 Multiple TBF capability

The mobile station indicates its support of multiple TBFs in the 'Multiple TBF Capability' field in the *MS Radio Access Capabilities 2* Information Element which is included in the first PACKET RESOURCE REQUEST message sent to the network (e.g. in a two-phase access if multiple TBFs are requested directly from packet idle mode, or as part of the first PACKET RESOURCE REQUEST message on the PACCH if the initial TBF has been established using a one-phase access). The *MS Radio Access Capabilities 2* Information Element is also included in the GMM ATTACH REQUEST and ROUTING AREA UPDATE REQUEST message.

The network indicates whether it supports multiple TBFs in the 'Multiple TBF Capability' field in the *GPRS Cell Options* IE contained in the system broadcast information (i.e. PSI1, PSI13 and SI13). The network also includes the *GPRS Cell Options* IE in the DTM ASSIGNMENT COMMAND message and the PACKET ASSIGNMENT message during DTM procedures.

A mobile station cannot request multiple uplink TBFs in a DTM REQUEST message, but it includes and sets a new bit called 'Multiple TBF Capability' in the *Channel Request Description 2* information element in that message. Once it has moved into dual transfer mode through the establishment of a CS channel and a single TBF on a PS channel it may request multiple TBFs using the PACKET RESOURCE REQUEST message on the PACCH of the PDTCH in the same way as for packet transfer mode.

The network may assign multiple downlink TBFs to a mobile station which is already in dual transfer mode using the MULTIPLE TBF DOWNLINK ASSIGNMENT or MULTIPLE TBF TIMESLOT RECONFIGURE message on the PACCH of an existing TBF. For the case where there are no ongoing TBFs for a given MS, the network determines the mobile station's multiple TBF capabilities from the *MS RAC* IE which is provided by the SGSN with the downlink LLC PDUs.

The network may reconfigure the mobile station's TBFs during a CS channel reconfiguration which does not involve a cell change. On CS handover, all PS resources are dropped and have to be re-established in the new cell.

B.3 Multiple TBF procedures

B.3.1 Data multiplexing options

B.3.1.1 Single TBF per upper layer flow

If the mobile station has user data to send for two or more PFCs, it requests one uplink TBF for each PFC. In the downlink, the network may assign a separate TBF to the mobile station for each PFC for which there is user data to send or it may decide to perform downlink (DL) TBF sharing, see B.3.1.2.

If a single TBF per upper layer flow is established, the network assigns one RLC instance and one TBF for user data from one PFC. The QoS parameter settings for the TBF relate directly to the QoS requirements for the PFC.

B.3.1.2 DL TBF sharing

In the downlink the network may decide to perform DL TBF sharing for PFCs with similar QoS requirements which do not have strict delay requirements (i.e. background and interactive services). Multiplexing of user data from these different PFCs onto a single TBF is done on an LLC PDU basis and the PFC to which the user data belongs is only identifiable at the LLC layer using SAPI (i.e. the SGSN indicates a PFI associated with one user data flow when sending an LLC PDU associated with another user data flow to the BSS on the Gb interface). As a single RLC instance is used for all LLC PDUs delivered on that TBF, the different PFCs must use the same RLC mode.

B.3.1.3 Explicit UL TBF switching

The network allocates the new PFC ownership of the ongoing uplink TBF on which the PACKET RESOURCE REQUEST message was sent using the PACKET UPLINK ASSIGNMENT message.

B.3.2 RLC/MAC Signalling

In the single TBF configuration, RLC/MAC control messages relating to a particular TBF are sent to the network on the PACCH of a timeslot on which the TFI of that TBF is valid. For example, the (EGPRS) PACKET DOWNLINK ACK/NACK message is sent on the PACCH/U of an uplink timeslot on which the downlink TFI is valid.

The network may choose not to assign to a mobile station with multiple active TBFs any resources on any of the uplink timeslots corresponding to the downlink timeslots on which the downlink TFI is valid (e.g. when an MS has been allocated more downlink timeslots than uplink timeslots). In this case the network must assign an 'uplink control timeslot' to the mobile station for those downlink TBFs allocated one or more timeslots for which no corresponding uplink timeslot has been allocated. The mobile station then sends the RLC/MAC control message on the assigned uplink control timeslot (where the downlink TFI is not a unique identifier) and adds the downlink timeslot number into the message in order for the network to identify the relevant TBF.

If the mobile station receives more than one assignment message, then the mobile station uses the uplink control timeslot given in the most recently received assignment message. It is the responsibility of the network to assign resources to a mobile station without violating its multislot capabilities.

Note that a 'downlink control timeslot' concept is not needed, as for the case where an MS has been allocated more uplink timeslots than downlink timeslots each uplink TBF will always have at least one uplink timeslot for which there is a corresponding downlink timeslot. This is possible through the use of extended dynamic allocation where MS permission to transmit on a given uplink timeslot may be provided on a downlink timeslot that does not directly correspond to that uplink timeslot.

B.3.3 TBF establishment

B.3.3.1 TFI allocation

A TBF is assigned one TFI value which is valid on all of the timeslots on which data for this TBF may be sent. The network assigns the TFI value and all the valid timeslots for the TBF in the assignment message. A multislot mobile may therefore have some TBFs with TFI values which are valid for fewer than all of the timeslots assigned to the

mobile station. These timeslot restrictions are specified by the network at the TBF assignment. Similarly the network will only assign a USF value to an uplink TBF for those timeslots on which data for this TBF may be sent.

The result of this is that although no TFI values are wasted, the uplink control timeslot concept is needed to allow RLC/MAC control messages relating to a downlink TBF to be sent on an uplink timeslot where this TFI is not valid, see B.3.2.

Data for one PFC is assigned a single TBF at the TBF establishment, thus creating a one-to-one relationship between PFI and TFI.

B.3.3.2 Single TBF request / establishment

A mobile station in packet idle mode supporting multiple TBF procedures may request a single uplink TBF according to existing procedures, using either one-phase or two-phase access. The mobile station must include the PFI to be associated with each TBF. The network may respond with either a PACKET UPLINK ASSIGNMENT or a PACKET TIMESLOT RECONFIGURE message (see section 7 of TS 44.060).

The network may send a PACKET DOWNLINK ASSIGNMENT message to a mobile station in packet idle mode to assign a downlink TBF to the mobile station.

The network may send a PACKET UPLINK/DOWNLINK ASSIGNMENT or a PACKET TIMESLOT RECONFIGURE message to a mobile station in packet transfer mode. All ongoing TBFs which are not included in the message are released and the explicitly addressed TBFs are either reconfigured (if already active) or established (if not active beforehand).

When assigning a single uplink TBF and/or a single downlink TBF in a PACKET UPLINK ASSIGNMENT, PACKET DOWNLINK ASSIGNMENT or PACKET TIMESLOT RECONFIGURE message to a mobile station which supports multiple TBF procedures, the network must indicate a PFI to be associated with each TBF. This ensures that if the mobile station requests additional TBFs, the PFI can be used as a flow identifier in accordance with multiple TBF procedures.

B.3.3.3 Multiple TBF establishment / reconfiguration

B.3.3.3.1 Multiple uplink TBF request / establishment

The mobile station in packet idle mode may request multiple TBFs by performing a two-phase access according to existing procedures (on CCCH or PCCCH) and including the multiple TBF request information in the *Extended Channel Request Description* IE of the PACKET RESOURCE REQUEST message.

The mobile station may request multiple TBFs from packet transfer mode or dual transfer mode by including the multiple TBF request information in the *Extended Channel Request Description* IE of the PACKET RESOURCE REQUEST message.

In response to a PACKET RESOURCE REQUEST message requesting multiple uplink TBFs, the network may send one of the following messages:

- PACKET ACCESS REJECT message rejecting the whole request (the mobile station may retry after T3172 expires).
- PACKET UPLINK ASSIGNMENT message assigning an uplink TBF to the PFC in the multiple TBF request having the highest priority (See note 1). On reception of this message the mobile station shall release all ongoing uplink TBFs. The mobile station cannot have more than one uplink TBF ongoing as a result of receiving this message.
- PACKET UPLINK ASSIGNMENT message indicating the PFI of the PFC using an ongoing uplink TBF to indicate that the corresponding ongoing uplink TBF is being reconfigured. The mobile station interprets this as not being the response to the multiple TBF resource request (See note 2). However any other previously assigned uplink TBFs are implicitly released upon reception of the PUA message. The mobile station cannot have more than one uplink TBF ongoing as a result of receiving this message.
- PACKET TIMESLOT RECONFIGURE message to indicate that an ongoing uplink TBF is being reconfigured and that also an ongoing downlink TBF is being reconfigured. The mobile station interprets this as not being the response to the multiple TBF resource request (See note 2). The mobile station cannot have more than one uplink and one downlink TBF ongoing as a result of receiving this message.

Note 1: If the PFI is one of the PFIs included in the multiple TBF request the mobile station interprets the PACKET UPLINK ASSIGNMENT as the response to the multiple TBF resource request and therefore an MTUA/MTTR response is not going to be sent (See explicit TBF sharing).

Note 2: If the PFI addresses a PFC using an ongoing TBF, this indicates to the mobile station that the mTBF request is still outstanding, so it should wait for a MTUA/MTTR response.

Alternatively, the network may send one or more of the following messages (according to multiple TBF procedures):

- PACKET ACCESS REJECT message rejecting part of the multiple TBF request indicated by a list of PFIs (the mobile station may retry for the rejected TBFs after T3172 expires). In the case of a partial rejection the network assigns resources for one or more of the TBFs requested by the mobile station, as a partial reject of a resource request is not treated as an abnormal case.
- MULTIPLE TBF UPLINK ASSIGNMENT message to assign one or more uplink TBFs.
- MULTIPLE TBF TIMESLOT RECONFIGURE message to reassign the ongoing resources at the same time as assigning new resources.

B.3.3.3.2 Multiple downlink TBF establishment

The network cannot assign multiple downlink TBFs to the mobile station straight from packet idle mode, it must first assign a single downlink TBF using the (P)CCCH procedures and then send the MULTIPLE TBF DOWNLINK ASSIGNMENT or MULTIPLE TBF TIMESLOT RECONFIGURE message to the mobile station on the PACCH.

If the mobile station already has one or more uplink TBFs, the network may assign one or more downlink TBFs by sending a MULTIPLE TBF DOWNLINK ASSIGNMENT or MULTIPLE TBF TIMESLOT RECONFIGURE message to the mobile station on the PACCH.

If the mobile station has more than one uplink or downlink TBF ongoing and receives a PACKET TIMESLOT RECONFIGURE message, it shall only keep the uplink TBF and downlink TBF specified in that message. The mobile station cannot have more than one uplink and one downlink TBF ongoing as a result of receiving this message.

On reception of a PACKET DOWNLINK ASSIGNMENT message, it shall release all ongoing downlink TBFs. The mobile station cannot have more than one downlink TBF ongoing as a result of receiving this message.

B.3.3.3.3 Usage of multiple TBF assignment messages

The MULTIPLE TBF UPLINK/DOWNLINK ASSIGNMENT messages do not have any impact on ongoing TBFs which are not explicitly addressed in the message. However the MULTIPLE TBF TIMESLOT RECONFIGURE message is used to implicitly release all ongoing TBFs which are not explicitly addressed in the message.

The MULTIPLE TBF TIMESLOT RECONFIGURE message should only be used by the network if more than one TBF is currently assigned or if the resulting configuration after reception of the message consists of more than one TBF in one direction. Even if these rules are violated the mobile station should always act on the message.

Table 1 – Message Usage Rules

Assignment messages used		Number of downlink TBFs (after assignment)		
		0	1	2 or more
Number of uplink TBFs (after assignment)	0	-	PDA / MTTR (1)	MTDA / MTTR (3)
	1	PUA / MTTR (1)	PTR / MTTR (1)	MTUA / MTDA / MTTR
	2 or more	MTUA / MTTR (2)	MTUA / MTDA / MTTR	MTUA / MTDA / MTTR

- (1) If the mobile station had multiple active TBFs prior to the assignment.
- (2) If the mobile station had downlink active TBFs prior to the assignment.
- (3) If the mobile station had uplink active TBFs prior to the assignment.

Example 1: In the case of the MTTR, this message is used to reconfigure a mobile station which has more than one TBF in either direction prior to the reconfiguration. Thus it may be that the network reassigns only a single TBF in either or each direction as a result, but the MTTR message still is used (as this indicates to the mobile station that all other TBFs are to be released).

Example 2: If a mobile station has multiple uplink TBFs, but no downlink TBFs, the network sends an MTDA message to the mobile station even if it is only for a single DL TBF assignment.

B.4 RLC/MAC Timers

B.4.1 TBF timers

On the mobile side the timers T3164, T3168, T3172, T3180, T3182, T3184, T3190, T3192 and T3194 are related to a TBF instance. The new mobile station timer T3188 is not related to a TBF instance, as it supervises the contention resolution (see B.4.2).

On the network side the timers T3169, T3191, T3193 and T3195 are related to one TBF instance, as the action on expiry of these timers is the release of the TBF resources.

B.4.2 Contention resolution timer

T3188 has been introduced to control the time within which contention resolution should be completed. It is started in the mobile station when a PACKET RESOURCE REQUEST message requesting two or more uplink TBFs is sent to the network in the second phase of a two-phase access requesting multiple TBFs and is stopped upon receipt of the MULTIPLE TBF UPLINK ASSIGNMENT message or a PACKET UPLINK ASSIGNMENT message.

T3188 runs in parallel to the T3168 timers which are started for each resource request, and may have the same value as T3168. There is only one instance of this timer in the mobile station, and the expiry of this timer indicates the failure of the mobile station's access rather than of an individual TBF establishment attempt.

B.5 CSN.1 coding of multiple TBF messages

B.5.1 MULTIPLE TBF UPLINK ASSIGNMENT message

Ongoing TBFs that are not explicitly addressed in this message are left unchanged. In the main body of the MULTIPLE TBF UPLINK ASSIGNMENT message is the following:

```
{ 0 | 1 < Uplink TBF Assignment : < Uplink Assignment struct > > }
```

```
< Uplink Assignment struct > ::=
  < EXTENDED_DYNAMIC_ALLOCATION : bit (1) >
  { 0 | 1 < Uplink Control Timeslot : bit (3) > }
  { 0 | 1 < P0 : bit (4) >
    < PR_MODE : bit(1) > }
  { 0 | 1 < TBF Starting Time : < Starting Frame Number Description IE > > }
  { 0 | 1 < Global Timeslot description : < Timeslot description struct > >
    { 1 < Uplink TBF Assignment : < Uplink TBF Assignment struct > > } ** 0 };
```

This struct gives all the information that is only given once per assignment message, including:

- whether extended dynamic allocation is used (if it is, it will be used over the set of timeslots indicated in the Timeslot Description),
- whether an Uplink Control Timeslot has been assigned to the mobile station,
- whether the assignments contained in this message are not immediately valid (TBF starting time delays the validity of the assignments until this time) and
- which uplink timeslots which have been assigned to the mobile station in this message. Note that this is a bit field (ignoring USF allocation) which indicates all of the uplink timeslots assigned resources in this message (e.g. 00111000 means that at least one TBF is assigned to each of timeslots 2, 3, 4). It is NOT required for all TBFs to be valid on ALL these timeslots (see the TBF Timeslot Allocation field).

```

< Uplink TBF Assignment struct > ::=
  { 0 < RB Id : bit (5) > | 1 < PFI : bit (7) > }
  < TFI Assignment : bit (5) >
  { 0 | 1 < CHANNEL_CODING_COMMAND : bit (2) > }
  { 0 | 1 < EGPRS Channel Coding Command : < EGPRS Modulation and Coding Scheme IE > > }
  { 0 | 1 < EGPRS Window Size : < EGPRS Window Size IE > > }
  { 0
    -- The timeslots assigned to the TBF are all the timeslots assigned
    -- in the Global Timeslot description
  | 1 < TBF_TIMESLOT_ALLOCATION : bit (N) > } -- The timeslots assigned to the TBF are a subset of all the
    -- timeslots assigned in the Global Timeslot description. Where
    -- N is the amount of timeslots assigned to the MS in the Global
    -- Timeslot description
  { 0 < USF_ALLOCATION : bit (3) > -- The same USF is valid on all timeslots assigned to the TBF
  | 1 -- Different USF(s) assigned
    < USF_ALLOCATION : bit (3) > -- USF assignment on the lowest numbered timeslot
    -- assigned to the TBF
    { 0 | 1 < USF_ALLOCATION : bit (3) > } * (M-1) ; -- USFs on subsequent timeslots assigned to the TBF:
    -- A "0" (respectively a "1" followed by a USF value)
    -- means same (respectively different) USF value as the
    -- USF on the next lower numbered timeslot assigned to
    -- the TBF. Where M is the amount of timeslots assigned
    -- to the TBF in the TBF_TIMESLOT_ALLOCATION if
    -- present, else in the Global Timeslot description

```

The length of the TBF_TIMESLOT_ALLOCATION field is equal to the number of timeslots marked as being assigned to the mobile station in the Global Timeslot description struct in the Uplink Assignment struct. It allows multiple TBFs to have different timeslot allocations, if it is not included then all TBFs assigned in this message share the timeslot allocation as described in the Global Timeslot description.

This coding allows the network to assign different parameters (timeslots, USFs) for each TBF in the message but is optimized for the cases where:

- a) The TBF is assigned on all timeslots in the Global Timeslot Description; or
 - b) The TBF is assigned on a subset of the timeslots indicated in the Global Timeslot Description;
- and
- c) the same USF is used on all timeslots of the TBF; or
 - d) there are different USFs for the TBF, but the same USF is used on consecutive timeslots of the TBF.

B.5.2 MULTIPLE TBF DOWNLINK ASSIGNMENT message

Ongoing TBFs that are not explicitly addressed in this message are left unchanged. In the main body of the MULTIPLE TBF DOWNLINK ASSIGNMENT message is the following:

```

{ 1 < Multiple Downlink TBF Assignment : < Multiple Downlink TBF Assignment struct > > } ** 0

```

which indicates that the following struct may be repeated.

```

< Multiple Downlink TBF Assignment struct > ::=
  < TIMESLOT_ALLOCATION : bit (8) >
  { 1 < Downlink TBF assignment : < Downlink TBF assignment struct > > } ** 0 ;

```

This struct is repeated for each set of TBFs that share a common downlink timeslot allocation. For example, if the mobile station is assigned two downlink TBFs where each operates on timeslots 4 and 5, plus another downlink TBF that is only assigned on timeslot 5, this would require two instances of the Multiple Downlink TBF Assignment struct in this message.

This approach is used because it is more likely for different downlink TBFs to share a common timeslot allocation than it is for uplink TBFs. Hence this coding is optimised for the case where all downlink TBFs allocated to a given mobile station are valid on all timeslots (leaving the network to perform the scheduling as necessary).

```

< Downlink TBF assignment struct > ::=
{ 0 < RB Id : bit (5) >
| 1 < PFI : bit (7) > < RLC_mode : bit (1) > }
< TFI Assignment : bit (5) >
< CONTROL_ACK : bit (1) >
{ 0 | 1 < EGPRS Window Size : < EGPRS Window Size IE >> }
{ 0 | 1 < HFN_LSB : bit (1) > };      -- HFN_LSB field used in lu mode only

```

This struct is repeated for each TBF that is assigned resources in the message. Each of these repeats may be associated with the same instance of the 'Multiple Downlink TBF Assignment struct' (i.e. when multiple downlink TBFs share the same downlink timeslot allocation) or with different instances of the 'Multiple Downlink TBF Assignment struct' (i.e. when the downlink TBFs do not share the same downlink timeslot allocation).

B.5.3 MULTIPLE TBF TIMESLOT RECONFIGURE message

The MULTIPLE TBF TIMESLOT RECONFIGURE message implicitly releases any TBFs which are not described in the message. It may be used to assign new resources as well as reconfigure existing resources and is needed when a mobile station is to be reconfigured onto a different carrier and all resources must be moved.

The MULTIPLE TBF TIMESLOT RECONFIGURE message is a combination of all the fields given in the MULTIPLE TBF DOWNLINK ASSIGNMENT and MULTIPLE TBF UPLINK ASSIGNMENT messages except for the uplink control timeslot field, which may be defined per TBF according to the coding, but this is only used for *lu mode*. Hence the coding of this message in A/Gb mode should ensure that the uplink control timeslot is defined only once per message.

The length of this message has been shown to fit into two radio blocks in the majority of scenarios, assuming up to 4 TBFs are assigned in each direction.

Annex C (informative): Change history

SPEC	SMG#	CR	PHA	VERS	NEW_VER	SUBJECT
03.64	s22	NEW	2+	2.1.1	5.0.0	GSM 03.64 GPRS Stage 2 Radio
03.64	s23	A022	R97	5.0.0	5.1.0	Unacknowledged mode of RLC/MAC operation
03.64	s23	A023	R97	5.0.0	5.1.0	Improved RLC Service Primitives
03.64	s23	A024	R97	5.0.0	5.1.0	Enhancements to dynamic allocation
03.64	s23	A025	R97	5.0.0	5.1.0	Clarifications to DRX
03.64	s23	A026	R97	5.0.0	5.1.0	Optimisation for network control cell reselection
03.64	s23	A027	R97	5.0.0	5.1.0	Abnormal Cases in GPRS MS Ready State: Leaky Bucket Procedure
03.64	s23	A029	R97	5.0.0	5.1.0	Multiframe structure (details) (revision of SMG2 GPRS 301/97)
03.64	s23	A030	R97	5.0.0	5.1.0	Abnormal Cases in GPRS MS Ready State
03.64	s23	A031	R97	5.0.0	5.1.0	Cell Re-Selection in GPRS
03.64	s23	A032	R97	5.0.0	5.1.0	Definition of PACCH
03.64	s23	A033	R97	5.0.0	5.1.0	Clarifications on Timing advance procedure
03.64	s23	A035	R97	5.0.0	5.1.0	Bit order for USF coding in GPRS
03.64	s23	A036	R97	5.0.0	5.1.0	PTM-M
03.64	s23	A037	R97	5.0.0	5.1.0	Contention resolution
03.64	s23	A039	R97	5.0.0	5.1.0	Deleting parameter XHYST
03.64	s24	A031	R97	5.1.0	5.2.0	Clarification on the use of hysteresis for cell re-selection
03.64	s25	A043	R97	5.2.0	6.0.0	Clarification of the use of TAI
03.64	s25	A049	R97	5.2.0	6.0.0	USF granularity for dynamic allocation
03.64	s26		R97	6.0.0	6.0.1	Editorial changes for Publication
03.64	s27	A050	R97	6.0.1	6.1.0	Changes on all chapters to align the spec. with other GPRS specifications.
03.64	s27	A044	R97	6.0.1	6.1.0	Clarification on PACCH allocation for fixed assignment
03.64	s28	A052	R97	6.1.0	6.2.0	PBCCH scheduling and editorial corrections
03.64	s28	A051	R97	6.1.0	6.2.0	Interference measurements on network control
03.64	s28	A053	R97	6.1.0	6.2.0	51-multiframe PBCCH
03.64	s29	A055	R97	6.2.0	6.3.0	Miscellaneous corrections
03.64	s29	A056	R97	6.2.0	6.3.0	Clarification of polling response
03.64	s29	A057	R97	6.2.0	6.3.0	Correction to 1 phase access contention resolution
03.64	s29	A054	R99	6.2.0	8.0.0	Introduction of Enhanced GPRS (EGPRS)
03.64	s30	A066	2	8.0.0	8.1.0	MT packet transfer
03.64	s30	A058		8.0.0	8.1.0	EGPRS fine tuning
03.64	s30	A059	1	8.0.0	8.1.0	EDGE Compact Cell Reselection
03.64	s30	A060	1	8.0.0	8.1.0	EDGE Compact logical channels
03.64	s30bis	A067		8.1.0	8.2.0	Correction for EGPRS
03.64	s30bis	A068		8.1.0	8.2.0	Introduction of Incremental Redundancy between different coding schemes in EGPRS
03.64	s31	A069		8.2.0	8.3.0	GPRS & SMS-CB interworking
03.64	s31bis	A070	R99	8.3.0	8.4.0	8-PSK support in UL
03.64	s32	A072r2	R99	8.4.0	8.5.0	DTM: Stage 2 Description

						September 2000 TSG-GERAN
03.64	G01	A073	1	8.5.0	8.6.0	CR 03.64-A073 rev 1 DTM (R99)
03.64	G01	A074		8.5.0	8.6.0	CR 03.64-A074 DTM+EGPRS (R99)
03.64	G01	A075	1	8.5.0	8.6.0	CR 03.64-A075 rev 1 DTM: alignments (R99)
03.64	G03	A077		8.6.0	8.7.0	Removal of Anonymous Access
03.64	G03	A078	1	8.6.0	8.7.0	Correction to the ordering of E/FBI bits
03.64 43.064	G03	A076	4	8.7.0	4.0.0	Introduction of Network Assisted Cell Change feature in the stage 2 description

Change history							
Date	TSG #	TSG Doc.	CR	Rev	Subject/Comment	Old	New
2001-04	04	GP-010962	001		Modulation based multislot class	4.0.0	4.1.0
2001-04	04	GP-010951	002		Applicability of GPRS requirements to EGPRS	4.0.0	4.1.0
2001-11	07	GP-012506	004		Coding rate of MCS3	4.1.0	4.2.0
2001-11	07	GP-012525	005		Clarification of EGPRS MS USF decoding	4.1.0	4.2.0
2002-02	08	GP-020427	006	1	Network requirements for MS synchronisation	4.2.0	4.3.0
2002-04	09	GP-020654	007		Removal of Fixed Allocation	4.3.0	5.0.0
2003-04	14	GP-030982	009	1	Padding for MCS-8 retransmissions	5.0.0	5.1.0
2003-05					Make figures 20 & 25 legible again.	5.1.0	5.1.1
2003-06	15	GP-031382	014		Editorial correction of references	5.1.1	6.0.0
2003-08	16	GP-031945	011	1	Removal of the close-ended TBF feature	6.0.0	6.1.0
2003-08	16	GP-032277	016	4	Multiple TBFs Stage 2	6.0.0	6.1.0
2004-04	19	GP-041194	020	2	Change of DTM core capability	6.1.0	6.2.0
2004-04	19	GP-040815	021		Removal of GPRS Extended Measurement reporting	6.1.0	6.2.0
2004-04	19	GP-040817	022		Removal of GPRS Idle Interference Measurements	6.1.0	6.2.0
2004-06	20	GP-041489	023		Addition of DTM enhancements	6.2.0	6.3.0
2004-08	21	GP-042016	024		Data rates for GPRS	6.3.0	6.4.0
2004-11	22	GP-042662	017	3	Annex on multiple TBF procedures	6.4.0	6.5.0
2004-11	22	GP-042364	025		MS behaviour in DTM resource reallocation during uplink TBF establishment	6.4.0	6.5.0
2004-11	22	GP-042882	026	2	Removal of PTM-M	6.4.0	6.5.0
2004-11	22	GP-042885	027	2	Introduction of MBMS	6.4.0	6.5.0
2005-04	24	GP-051131	029	2	Extension of DTM to high multislot classes	6.5.0	6.6.0
2005-06	25	GP-051782	030	2	BSS controlled RLC mode selection	6.6.0	6.7.0
2005-09	26	GP-052316	031	1	GPRS stage 2 alignment with stage 3 for 2 phase access procedure	6.7.0	6.8.0
2005-09	26	GP-052237	032	1	Correction to Rules for Monitoring USF in Extended Dynamic Allocation	6.7.0	6.8.0
2005-11	27	GP-052844	0033	1	MBMS transfer mode	6.8.0	6.9.0
2006-01	28	GP-060204	0035		Correction to the introduction of MBMS transfer mode	6.9.0	6.10.0

History

Document history		
V6.5.0	November 2004	Publication
V6.6.0	April 2005	Publication
V6.7.0	June 2005	Publication
V6.8.0	September 2005	Publication
V6.9.0	November 2005	Publication
V6.10.0	January 2006	Publication