

ETSI TS 144 160 V5.5.0 (2003-07)

Technical Specification

**Digital cellular telecommunications system (Phase 2+);
General Packet Radio Service (GPRS);
Mobile Station (MS) - Base Station System (BSS) interface;
Radio Link Control/Medium Access Control (RLC/MAC)
protocol for Iu mode
(3GPP TS 44.160 version 5.5.0 Release 5)**



Reference

RTS/TSGG-0244160v550

Keywords

GSM

ETSI

650 Route des Lucioles
F-06921 Sophia Antipolis Cedex - FRANCE

Tel.: +33 4 92 94 42 00 Fax: +33 4 93 65 47 16

Siret N° 348 623 562 00017 - NAF 742 C
Association à but non lucratif enregistrée à la
Sous-Préfecture de Grasse (06) N° 7803/88

Important notice

Individual copies of the present document can be downloaded from:

<http://www.etsi.org>

The present document may be made available in more than one electronic version or in print. In any case of existing or perceived difference in contents between such versions, the reference version is the Portable Document Format (PDF). In case of dispute, the reference shall be the printing on ETSI printers of the PDF version kept on a specific network drive within ETSI Secretariat.

Users of the present document should be aware that the document may be subject to revision or change of status. Information on the current status of this and other ETSI documents is available at

<http://portal.etsi.org/tb/status/status.asp>

If you find errors in the present document, send your comment to:

editor@etsi.org

Copyright Notification

No part may be reproduced except as authorized by written permission.
The copyright and the foregoing restriction extend to reproduction in all media.

© European Telecommunications Standards Institute 2003.
All rights reserved.

DECT™, PLUGTESTS™ and UMTS™ are Trade Marks of ETSI registered for the benefit of its Members.
TIPHON™ and the TIPHON logo are Trade Marks currently being registered by ETSI for the benefit of its Members.
3GPP™ is a Trade Mark of ETSI registered for the benefit of its Members and of the 3GPP Organizational Partners.

Intellectual Property Rights

IPRs essential or potentially essential to the present document may have been declared to ETSI. The information pertaining to these essential IPRs, if any, is publicly available for **ETSI members and non-members**, and can be found in ETSI SR 000 314: *"Intellectual Property Rights (IPRs); Essential, or potentially Essential, IPRs notified to ETSI in respect of ETSI standards"*, which is available from the ETSI Secretariat. Latest updates are available on the ETSI Web server (<http://webapp.etsi.org/IPR/home.asp>).

Pursuant to the ETSI IPR Policy, no investigation, including IPR searches, has been carried out by ETSI. No guarantee can be given as to the existence of other IPRs not referenced in ETSI SR 000 314 (or the updates on the ETSI Web server) which are, or may be, or may become, essential to the present document.

Foreword

This Technical Specification (TS) has been produced by ETSI 3rd Generation Partnership Project (3GPP).

The present document may refer to technical specifications or reports using their 3GPP identities, UMTS identities or GSM identities. These should be interpreted as being references to the corresponding ETSI deliverables.

The cross reference between GSM, UMTS, 3GPP and ETSI identities can be found under <http://webapp.etsi.org/key/queryform.asp>.

Contents

Intellectual Property Rights	2
Foreword.....	2
Foreword.....	10
1 Scope	11
1.1 General	11
1.2 Related documents	11
1.3 Use of logical control channels	11
1.4 Use of logical traffic channels	12
1.5 Conventions.....	12
2 References	12
3 Definitions, symbols and abbreviations	13
3.1 Definitions	13
3.2 Symbols.....	14
3.3 Abbreviations	14
4 Layered overview of radio interface.....	15
4.1 Layer services.....	16
4.2 Layer functions.....	16
4.2.1 RLC function	16
4.2.2 MAC layer function	17
4.3 Service primitives.....	18
4.3.1 MAC to Physical Layer Primitives	18
4.3.2 PDCP to RLC Primitives	18
4.3.2.1 Primitives	18
4.3.2.2 Primitive parameters	18
4.3.3 RRC to RLC Primitives	19
4.3.3.1 Primitives	19
4.3.3.2 Primitive parameters	20
4.3.4 RRC to MAC Primitives.....	20
4.3.4.1 Primitives	20
4.3.4.2 Primitive Parameters	21
4.4 Services required from lower layers.....	22
5 Introduction to the Medium Access Control (MAC) procedures	23
5.1 General	23
5.2 Multiplexing principles	23
5.2.1 Temporary Block Flow	23
5.2.2 Temporary Flow Identity	23
5.2.2.1 Temporary Flow Identity for SBPSCH.....	23
5.2.2.2 Temporary Flow Identity for DBPSCH	24
5.2.3 Uplink State Flag	24
5.2.4 Medium Access modes	24
5.2.4.1 Medium Access modes for SBPSCH	24
5.2.4.2 Medium Access modes for DBPSCH	24
5.2.5 Multiplexing of GPRS and EGPRS TBF mode capable mobile stations.....	24
5.3 MAC States	25
5.3.1 MAC-Idle state	25
5.3.1.1 General	25
5.3.1.2 Establishment of a SBPSCH	25
5.3.1.3 Establishment of a DBPSCH.....	25
5.3.2 MAC-Shared state	25
5.3.2.1 General	25
5.3.2.2 Release of all SBPSCHs.....	25
5.3.2.3 Establishment of a DBPSCH.....	25
5.3.2.4 Radio bearer reconfiguration.....	25
5.3.3 MAC-DTM state.....	25

5.3.3.1	General	25
5.3.3.2	Release of all SBPSCHs	26
5.3.3.3	Release of all DBPSCHs	26
5.3.3.4	Release of all SBPSCHs and DBPSCHs	26
5.3.4	MAC-Dedicated state	26
5.3.4.1	General	26
5.3.4.2	Release of all DBPSCHs	26
5.3.4.3	Radio bearer reconfiguration	26
5.3.5	MAC state machine	26
5.4	General MAC procedures in MAC-Idle state and MAC-Shared state	27
5.4.1	Mobile station side	27
5.4.1.1	General	27
5.4.1.2	Cell reselection	27
5.4.1.3	Network Assisted Cell Change	28
5.4.1.4	Release of DBPSCHs	28
5.4.1.4.1	General	28
5.4.1.4.2	Continuation of PBCCH information	28
5.4.1.4.3	Receipt of PSI14 message in MAC-DTM state	29
5.4.1.5	System information on PBCCH	29
5.4.1.6	System information on BCCH	29
5.4.1.6.1	General	29
5.4.1.6.2	Establishment of PBCCH	29
5.4.1.6.3	(void)	29
5.4.1.7	(void)	29
5.4.1.8	Discontinuous reception (DRX)	29
5.4.1.9	Page mode procedures on PCCCH	30
5.4.1.10	Frequency Parameters	30
5.4.1.11	G-RNTI Management	30
5.4.2	Network side	30
5.4.2.1	System Information broadcasting	30
5.4.2.1.1	System information on PBCCH	30
5.4.2.1.2	System information on BCCH	31
5.4.2.1.3	System information on PACCH (and other logical channels)	31
5.4.2.1.4	Consistent sets of system information messages	31
5.4.2.2	Paging	32
5.4.2.3	Network Assisted Cell Change	32
5.5	Measurement reports	32
5.5.1	General	32
5.5.2	Network Control (NC) measurement reporting	32
5.5.3	Extended measurement (EM) reporting	33
5.5.4	Additional measurement and reporting parameters	33
5.6	Mapping of Signalling Radio Bearers (SRB) onto logical channels	33
5.6.1	Downlink	33
5.6.2	Uplink	33
5.6.2.1	MAC-Dedicated State	33
5.6.2.2	MAC-Shared State	34
5.6.2.3	MAC-DTM State	34
6	Paging procedures	35
6.1	General	35
6.2	Paging initiation in MAC-Idle state	35
6.3	Paging initiation in MAC-Shared state	36
6.4	Reception of PACKET PAGING REQUEST by an MS	36
7	Medium Access Control (MAC) procedures on PCCCH	36
7.1	General	36
7.2	TBF establishment initiated by the mobile station on PCCCH	36
7.2.1	General	36
7.2.2	Permission to access the network	37
7.2.3	Initiation of a TBF establishment	37
7.2.3.1	Initiation of the packet access procedure	37
7.2.3.1.1	General	37
7.2.3.1.2	Access persistence control on PRACH	38

7.2.3.2	Packet assignment procedure	38
7.2.3.2.1	On receipt of a PACKET CHANNEL REQUEST or EGPRS PACKET CHANNEL REQUEST message.....	38
7.2.3.2.1.2	Allocation of resource on SBPSCH(s)	38
7.2.3.2.1.3	Allocation of resource on DBPSCH(s)	38
7.2.3.3	Contention resolution at one phase access	40
7.2.3.3.1	Contention resolution at one phase access on SBPSCHs	40
7.2.3.3.2	Contention resolution at one phase access on DBPSCH	41
7.2.3.4	RLC/MAC procedures during contention resolution	42
7.2.3.4.1	RLC/MAC procedures during contention resolution on SBPSCHs	42
7.2.3.4.2	RLC/MAC procedures during contention resolution on DBPSCHs.....	42
7.2.3.5	One phase packet access completion.....	43
7.2.3.5.1	One phase packet access completion on SBPSCHs.....	43
7.2.3.5.2	One phase packet access completion on DBPSCHs	43
7.2.3.6	Timing Advance.....	43
7.2.3.6.1	Timing advance on SBPSCHs	43
7.2.3.6.2	Timing advance on DBPSCHs	43
7.2.4	TBF establishment using two phase access	43
7.2.4.1	Initiation of the Packet resource request procedure	43
7.2.4.2	Packet resource assignment for uplink procedure	44
7.2.4.2.1	(void)	44
7.2.4.2.2	On receipt of a PACKET RESOURCE REQUEST message.....	44
7.2.4.3	Contention resolution at two phase access	44
7.2.4.4	Two phase packet access completion.....	45
7.2.4.5	Timing Advance.....	45
7.2.5	Abnormal cases.....	45
7.3	TBF establishment initiated by the network on PCCCH.....	46
7.3.1	General.....	46
7.3.2	Entering the MAC-Shared state	46
7.3.2.1	General	46
7.3.2.2	Packet downlink assignment procedure	46
7.3.2.2.1	Packet downlink assignment procedure.....	46
7.3.2.2.2	HFN synchronization.....	46
7.3.2.3	Packet downlink assignment procedure completion	46
7.3.2.4	Packet polling procedure.....	46
7.3.2.5	Abnormal cases	47
7.3.3	Entering the MAC-Dedicated state	47
7.3.3.1	General	47
7.3.3.2	Packet DBPSCH assignment procedure.....	47
7.3.3.3	Packet DBPSCH assignment procedure completion	47
7.3.3.4	Packet polling procedure.....	48
7.3.3.5	Abnormal cases	48
7.4	Procedure for measurement report sending in MAC-Idle state	48
7.4.1	General.....	48
7.4.2	Measurement report sending procedure initiated on PCCCH	48
7.4.2.1	General	48
7.4.2.2	On receipt of a PACKET CHANNEL REQUEST message	48
7.4.2.3	On receipt of a PACKET UPLINK ASSIGNMENT message.....	48
7.4.2.4	On receipt of a PACKET ACCESS REJECT message.....	49
7.4.2.5	Abnormal cases	49
7.5	Cell Change Order procedures in MAC-Idle state	49
7.5.1	General.....	49
7.6	Measurement Order procedures in MAC-Idle state.....	49
7.6.1	General.....	49
7.6.2	Measurement Order procedures initiated on PCCCH	50
8	Medium Access Control (MAC) procedures on SBPSCH.....	50
8.1	General	50
8.1a	Resource stealing (SFACCH).....	50
8.2	Transfer of RLC data blocks	51
8.2.1	Medium access mode.....	51
8.2.2	Uplink RLC data block transfer.....	51

8.2.2.0	General	51
8.2.2.0.1	General	51
8.2.2.0.2	Establishment of additional uplink TBF(s).....	51
8.2.2.0.3	Uplink resource reallocation / reconfiguration	51
8.2.2.0.4	Establishment of downlink TBF(s).....	52
8.2.2.1	Dynamic Allocation uplink RLC data block transfer.....	52
8.2.2.1.1	PACCH operation.....	52
8.2.2.1.2	Resource Allocation / Reallocation for Uplink.....	52
8.2.2.1.2.2	On receipt of the PACKET RESOURCE REQUEST	52
8.2.2.1.3	Establishment of downlink TBF.....	54
8.2.2.1.3.1	General.....	54
8.2.2.1.3.2	Abnormal cases.....	55
8.2.2.2	Extended Dynamic Allocation uplink RLC data block transfer.....	55
8.2.2.2.0	General	55
8.2.2.2.1	Uplink PDCH Allocation.....	55
8.2.2.2.2	PACCH operation.....	55
8.2.2.2.3	Neighbour cell power measurements.....	56
8.2.2.3	Exclusive Allocation uplink RLC data block transfer.....	56
8.2.2.3.1	(void).....	56
8.2.2.3.2	(void).....	56
8.2.2.3.3	(void).....	56
8.2.2.3.4	(void).....	56
8.2.2.3.5	(void).....	56
8.2.2.3.6	(void).....	56
8.2.2.4	Network initiated release of uplink TBF.....	56
8.2.2.5	Abnormal cases	56
8.2.3	Downlink RLC data block transfer	56
8.2.3.1	General	56
8.2.3.1.0	General	56
8.2.3.1.1	Downlink resource reallocation.....	57
8.2.3.1.2	(void).....	57
8.2.3.2	Downlink RLC data block transfer procedure	57
8.2.3.2.0	General	57
8.2.3.2.1	Abnormal cases	57
8.2.3.3	Polling for Packet Downlink Ack/Nack.....	59
8.2.3.4	Resource Reassignment for downlink.....	59
8.2.3.5	Establishment of uplink TBF	60
8.2.3.5.0	General	60
8.2.3.5.1	Abnormal cases	60
8.2.3.6	Network initiated abnormal release of downlink TBF	62
8.3	Packet PDCH Release	62
8.4	Procedure for measurement report sending in MAC-Shared state	62
8.5	Network Controlled cell reselection procedures in MAC-Shared state	62
8.6	Measurement Order procedures in MAC-Shared state.....	62
8.7	PACKET CONTROL ACKNOWLEDGEMENT	62
8.8	Abnormal cases	62
8.8.1	General.....	62
8.8.2	Abnormal release without retry	62
8.8.3	Abnormal release with access retry	62
8.8.4	Abnormal release with system information	62
8.8.5	Abnormal release of an Uplink TBF with access retry	63
8.8.6	Abnormal release of a Downlink TBF.....	63
8.9	Network Assisted Cell Change procedures in MAC-Shared state.....	63
9	Medium Access Control (MAC) procedures on DBPSCH	63
9.1	General	63
9.2	Transfer of RLC/MAC blocks.....	64
9.2.0	General.....	64
9.2.1	Dedicated allocation	64
9.2.1.1	General.....	64
9.2.1.2	Performance requirements for TCH and DCCH TBF modes.....	65
9.2.2	Transfer of RLC/MAC blocks on TCH	65

9.2.3	Transfer of RLC/MAC blocks on FACCH, SACCH and SDCCH.....	66
9.2.4	Transfer of RLC/MAC blocks on PDTCH and PACCH	66
9.2.4.1	General.....	66
9.2.4.1.1	Downlink transfer.....	66
9.2.4.1.1.1	General.....	66
9.2.4.1.1.2	Polling for Packet Downlink Ack/Nack.....	67
9.2.4.1.2	Uplink transfer.....	67
9.2.4.1.2.1	General.....	67
9.2.4.1.2.2	On receipt of a Packet Uplink Assignment message.....	68
9.2.4.1.2.3	Release of the USF	69
9.2.4.2	Scheduling an inactive TBF on a DBPSCH.....	69
9.2.4.3	Further USF handling.....	69
9.3	PACKET CONTROL ACKNOWLEDGEMENT	69
9.3a	Handover Access and Physical Information.....	70
9.3a.1	Handover Access	70
9.3a.2	Physical Information.....	70
9.4	Abnormal cases	70
10	Radio Link Control (RLC) procedures on PDTCH and PACCH.....	71
10.1	General	71
10.2	Procedures and parameters for peer-to-peer operation.....	71
10.2.1	Send state variable V(S)	71
10.2.2	Control send state variable V(CS)	71
10.2.3	Acknowledge state variable V(A).....	71
10.2.4	Acknowledge state array V(B).....	71
10.2.5	Block sequence number BSN	71
10.2.6	Receive state variable V(R)	71
10.2.7	Receive window state variable V(Q)	71
10.2.8	Receive state array V(N).....	71
10.2.9	Starting sequence number (SSN) and received block bitmap (RBB)	71
10.2.10	Window Size.....	71
10.2.10a	RLC buffer.....	72
10.2.11	Compression	72
10.2.12	Segmentation of upper layer PDUs into RLC data units	72
10.2.13	Re-assembly of upper layer PDUs from RLC data units	72
10.2.14	Segmentation of RLC/MAC control messages into RLC/MAC control blocks	72
10.2.15	Re-assembly of RLC/MAC control messages from RLC/MAC control blocks	73
10.3	Operation during RLC/MAC control message transfer	73
10.4	Operation during RLC data block transfer	73
10.4.1	General.....	73
10.4.2	Countdown procedure.....	73
10.4.3	Delayed release of downlink Temporary Block Flow	74
10.4.4	Extended uplink TBF mode	74
10.4.5	Acknowledged mode operation	74
10.4.5.1	General	74
10.4.5.2	Additional functionality in acknowledged EGPRS TBF Mode	74
10.4.5.3	Establishment of Temporary Block Flow	74
10.4.5.4	Operation of uplink Temporary Block Flow	74
10.4.5.5	Release of uplink Temporary Block Flow	74
10.4.5.6	Operation of downlink Temporary Block Flow	74
10.4.5.7	Release of downlink Temporary Block Flow.....	74
10.4.6	Unacknowledged mode operation.....	74
10.4.6.1	General	74
10.4.6.2	Establishment of Temporary Block Flow	74
10.4.6.3	Operation of uplink Temporary Block Flow	75
10.4.6.4	Release of uplink Temporary Block Flow	75
10.4.6.5	Operation of downlink Temporary Block Flow	75
10.4.6.6	Release of downlink Temporary Block Flow.....	75
10.5	Abnormal release cases	75
10.5.1	Abnormal release with access retry	75
10.5.2	Abnormal release with cell reselection	75
10.6	Uplink TBF release in extended uplink TBF mode.....	75

11	Radio Link Control (RLC) procedures on TCH, FACCH, SACCH and SDCCH	76
11.1	General	76
11.2	Procedures and parameters for peer-to-peer operation	77
11.2.1	Send state variable V(S)	77
11.2.2	Control send state variable V(CS)	77
11.2.3	Acknowledge state variable V(A)	77
11.2.4	Acknowledge state array V(B)	77
11.2.5	Block sequence number BSN	77
11.2.5.1	Block sequence number for TCH TBF mode	77
11.2.5.2	Block sequence number for DCCH TBF mode	78
11.2.6	Reduced block sequence number RBSN	78
11.2.7	Receive state variable V(R)	78
11.2.8	Receive window state variable V(Q)	78
11.2.9	Receive state array V(N)	78
11.2.10	Starting sequence number (SSN) and received block bitmap (RBB)	78
11.2.11	Window Size	79
11.2.11.1	TCH	79
11.2.11.2	FACCH, SACCH and SDCCH	79
11.2.11a	RLC buffer	79
11.2.12	Segmentation of upper layer PDUs into RLC data units	79
11.2.13	Re-assembly of upper layer PDUs from RLC data units	79
11.2.14	Segmentation of RLC/MAC control messages into RLC/MAC control blocks	79
11.2.15	Re-assembly of RLC/MAC control messages from RLC/MAC control blocks	80
11.3	Operation during RLC/MAC control message transfer	80
11.4	Operation during RLC data block transfer	80
11.4.1	General	80
11.4.2	Acknowledged mode operation	81
11.4.2.1	General	81
11.4.2.2	On TCH	81
11.4.2.2.1	General	81
11.4.2.2.2	Uplink	81
11.4.2.2.3	Downlink	81
11.4.2.3	On FACCH, SACCH or SDCCH	82
11.4.2.3.1	General	82
11.4.2.3.2	Uplink	82
11.4.2.3.3	Downlink	82
11.4.3	Unacknowledged mode operation	83
11.4.3.1	General	83
11.4.3.2	On TCH	83
11.4.3.2.1	Uplink	83
11.4.3.2.2	Downlink	83
11.4.3.3	On FACCH, SACCH or SDCCH	84
11.4.3.3.1	Uplink	84
11.4.3.3.2	Downlink	84
11.4.4	Transparent mode operation (TCH TBF mode only)	84
12	RLC/MAC block structure	84
12.1	RLC/MAC block structure	84
12.2	RLC/MAC block format conventions	84
12.3	Spare bits	84
12.4	GPRS RLC data blocks (PDTCH)	85
12.4.1	Downlink RLC data block	85
12.4.2	Uplink RLC data block	85
12.5	RLC/MAC control blocks (PACCH)	86
12.6	EGPRS RLC data blocks and RLC/MAC headers (PDTCH)	86
12.6.1	General	86
12.6.2	EGPRS downlink RLC data block	86
12.6.3	EGPRS uplink RLC data block	86
12.6.4	EGPRS downlink RLC/MAC header	86
12.6.5	EGPRS uplink RLC/MAC header	86
12.7	RLC/MAC block formats on FACCH, SACCH and SDCCH	87
12.7.1	RLC/MAC block	87

12.7.2	Downlink RLC/MAC block for data transfer	87
12.7.3	Uplink RLC/MAC block for data transfer	88
12.7.4	RLC/MAC block for control message transfer	88
12.8	RLC/MAC block format on TCH (NT-RLC).....	88
12.8.1	RLC/MAC block	88
12.8.1.1	General	88
12.8.1.2	RLC/MAC block for E-TCH/F28.8 coding scheme.....	89
12.8.1.3	RLC/MAC block for E-TCH/F32.0 coding scheme.....	89
12.8.1.4	RLC/MAC block for E-TCH/F43.2 coding scheme.....	89
12.8.2	Downlink RLC/MAC block for data transfer	90
12.8.3	Uplink RLC/MAC block for data transfer	90
12.8.4	RLC/MAC block for control message transfer	90
12.9	Header fields	90
12.9.1	General.....	90
12.9.2	Payload Type (PT) field.....	91
12.9.3	Polling (P) bit.....	91
12.9.4	Reduced Radio Bearer identity (RRBid) field	91
12.9.5	More (M) bit and Extension (E) bit	91
12.9.6	Extension bis (Ebis) bit.....	92
12.9.7	Stall Indicator (SI) bit	92
12.9.8	Ack Indicator (AI) field	92
12.9.9	Ack/Nack Description field	92
12.9.10	G-RNTI indicator (GI) bit.....	93
12.9.11	Segmentation (S) bit	93
12.9.12	Reduced Block Sequence Number (RBSN) bit	93
12.9.13	(void)	93
12.9.14	Radio Transaction Identifier (RTI) field.....	93
12.9.15	Block Sequence Number (BSN) field.....	93
12.9.16	Radio Bearer Identity (RB Id) field	93
12.9.17	Signalling Radio Bearer Identity (SRB Id) field.....	94
12.9.18	GERAN Radio Network Temporary Identity Extension (G-RNTI Extension) field	94
12.9.19	Length Indicator (LI) field.....	94
12.9.20	PFI Indicator (PI) field.....	94
12.9.21	HFN Least Significant Bit (HFN_LSB) field	94
13	Ciphering	94
13.1	General	94
13.2	Applicability of ciphering	95
13.3	Ciphering at RLC sublayer.....	95
13.3.1	General.....	95
13.3.2	Parameter settings	95
13.3.2.1	Input parameters to the ciphering algorithm	95
13.3.2.2	Handling of the HFN.....	95
13.3.3	Ciphering of RLC PDUs in non-transparent RLC mode	96
13.4	Ciphering at MAC sublayer.....	96
13.4.1	General.....	96
13.4.2	Parameter settings	96
13.4.2.1	Input parameters to the ciphering algorithm	96
13.4.2.2	Handling of the HFN.....	97
13.4.2.2.1	Ciphering in transparent RLC mode.....	97
13.4.2.2.2	Ciphering of RLC/MAC control messages.....	98
13.4.3	Ciphering of RLC/MAC control messages.....	98
13.4.4	Ciphering of RLC PDUs in transparent RLC mode.....	99
14	RLC suspension, stop and re-establishment procedures	99
14.1	General	99
14.2	Local suspend/resume function (NT-RLC)	99
14.3	Stop/continue function (NT-RLC)	100
14.4	RLC re-establishment function (NT-RLC).....	100
Annex A (informative): Change History		102
History		103

Foreword

This Technical Specification has been produced by the 3rd Generation Partnership Project (3GPP).

The contents of the present document are subject to continuing work within the TSG and may change following formal TSG approval. Should the TSG modify the contents of the present document, it will be re-released by the TSG with an identifying change of release date and an increase in version number as follows:

Version x.y.z

where:

- x the first digit:
 - 1 presented to TSG for information;
 - 2 presented to TSG for approval;
 - 3 or greater indicates TSG approved document under change control.
- y the second digit is incremented for all changes of substance, i.e. technical enhancements, corrections, updates, etc.
- z the third digit is incremented when editorial only changes have been incorporated in the document.

1 Scope

1.1 General

The present document specifies procedures for the following layers of the radio interface (*Um* reference point), the interface between the GSM/EDGE Radio Access Network (GERAN) and the Mobile Station (MS) in GERAN *Iu mode*:

- Radio Link Control (RLC).
- Medium Access Control (MAC), including Physical Link Control functions.

1.2 Related documents

The following documents provide information related to the present document:

- 3GPP TS 43.051 is an overall description of the GSM/EDGE Radio Access Network (GERAN) in *Iu mode*.
- 3GPP TS 44.003 specifies channel types, access capabilities and channel configurations at the *Um* reference point.
- 3GPP TS 44.004 specifies services offered by the physical layer of the *Um* reference point. It also specifies control channels. RLC and MAC use these services and control channels.
- 3GPP TS 24.007 specifies, in general terms, this protocol's structured functions, its procedures and its relationship with other layers and entities. It also specifies the basic message format and error handling applied by layer 3 protocols.
- 3GPP TS 44.118 specifies the RRC procedures when operating in *Iu mode*.
- 3GPP TS 44.060 specifies RLC/MAC procedures specific to *A/Gb mode* as well as the procedures that are common to both *A/Gb mode* and *Iu mode*. It also specifies the messages and Information Elements for both modes.
- 3GPP TS 51.010 specifies test procedures for radio-interface signalling.

1.3 Use of logical control channels

3GPP TS 45.002 defines the following logical control channels:

- Broadcast Control Channel (BCCH): downlink only, used to broadcast Cell specific information.
- Packet Broadcast Control Channel (PBCCH): downlink only, used to broadcast Cell specific information.
- Packet Paging Channel (PPCH): downlink only, used to send page requests to Mobile Stations (MSs).
- Packet Random Access Channel (PRACH): uplink only, used to request GPRS resources.
- Packet Access Grant Channel (PAGCH): downlink only, used to allocate GPRS resources.
- Packet Associated Control Channel (PACCH): bi-directional, associated with a Temporary Block Flow (TBF).
- Packet Timing advance control channel uplink (PTCCH/U): used to transmit random access bursts to allow estimation of the timing advance for one MS in transfer state.
- Packet Timing advance control channel downlink (PTCCH/D): used to transmit timing advance updates for several MS. One PTCCH/D is paired with several PTCCH/U's.

1.4 Use of logical traffic channels

3GPP TS 45.002 defines the following logical traffic channels used by RLC and MAC:

- Traffic Channel (TCH): bidirectional, carries encoded speech or user data using GMSK on a dedicated basic physical subchannel (DBPSCH). TCH can be full-rate (TCH/F) or half-rate (TCH/H).
- Octal Traffic Channel (O-TCH): bidirectional, carries encoded speech using 8-PSK on a DBPSCH. O-TCH can be full-rate (O-TCH/F) or half-rate (O-TCH/H).
- Enhanced Traffic Channel (E-TCH): bidirectional, carries user data using 8-PSK on a DBPSCH.
- Packet Data Traffic Channel (PDTCH): downlink or uplink, carries user data using GMSK or 8-PSK on a shared basic physical subchannel (SBPSCH) or a DBPSCH. PDTCHs can be full-rate (PDTCH/F) or half-rate (PDTCH/H).

1.5 Conventions

Unless explicitly stated otherwise, the following conventions apply:

- The notations "further study", "FS" or "FFS" indicate the annotated text is not normative.
- References to "PDCH" also apply to "SBPSCH" and vice-versa.

2 References

The following documents contain provisions which, through reference in this text, constitute provisions of the present document.

- References are either specific (identified by date of publication, edition number, version number, etc.) or non-specific.
- For a specific reference, subsequent revisions do not apply.
- For a non-specific reference, the latest version applies. In the case of a reference to a 3GPP document (including a GSM document), a non-specific reference implicitly refers to the latest version of that document *in the same Release as the present document*.

- [1] 3GPP TR 21.905: "Vocabulary for 3GPP Specifications".
- [2] 3GPP TS 23.003: "Numbering, addressing and identification".
- [3] 3GPP TS 43.013: "Discontinuous Reception (DRX) in the GSM system".
- [4] 3GPP TS 24.002: "GSM-UMTS Public Land Mobile Network (PLMN) access reference configuration".
- [5] 3GPP TS 44.003: "Mobile Station - Base Station System (MS - BSS) interface; Channel structures and access capabilities".
- [6] 3GPP TS 44.004: "Layer 1 - General requirements".
- [7] 3GPP TS 44.118: "Mobile radio interface layer 3 specification; Radio Resource Control (RRC) protocol Iu mode".
- [8] 3GPP TS 45.002: "Multiplexing and multiple access on the radio path".
- [9] 3GPP TS 45.003: "Channel coding".
- [10] 3GPP TS 45.008: "Radio subsystem link control".
- [11] 3GPP TS 45.010: "Radio subsystem synchronization".

- [12] 3GPP TS 51.010-1: "Mobile Station (MS) conformance specification; Part 1: Conformance specification".
- [13] 3GPP TS 51.021: "GSM radio aspects base station system equipment specification".
- [14] 3GPP TS 25.331: "Radio Resource Control (RRC) protocol specification".
- [15] 3GPP TS 25.133: "Requirements for support of radio resource management (FDD)".
- [16] 3GPP TS 25.123: "Requirements for support of radio resource management (TDD)".
- [17] 3GPP TS 43.051: "GSM/EDGE Radio Access Network (GERAN); Overall Description; Stage 2".
- [18] 3GPP TS 44.060: "General Packet Radio Service (GPRS); Mobile Station (MS) - Base Station System (BSS) interface; Radio Link Control/ Medium Access Control (RLC/MAC) protocol".
- [19] 3GPP TS 51.010-2: "Mobile Station (MS) conformance specification; Part 2: Protocol Implementation Conformance Statement (ICS) proforma specification".
- [20] 3GPP TS 51.010-3: "Mobile Station (MS) conformance specification; Part 3: Layer 3 (L3) Abstract Test Suite (ATS)".
- [21] 3GPP TS 51.010-4: "Mobile Station (MS) conformance specification; Part 4: SIM application toolkit conformance specification".
- [22] 3GPP TS 35.201: "Specification of the 3GPP confidentiality and integrity algorithms; Document 1: f8 and f9 specifications".
- [23] 3GPP TS 24.008: "Mobile radio interface Layer 3 specification; Core network protocols; Stage 3".
- [24] 3GPP TS 44.018: "Mobile radio interface layer 3 specification; Radio Resource Control Protocol".
- [25] 3GPP TS 45.005: "Radio transmission and reception".
- [26] 3GPP TS 43.064: "Overall description of the GPRS radio interface; Stage 2".
- [27] 3GPP TS 24.007: "Mobile radio interface signalling layer 3; General Aspects".

3 Definitions, symbols and abbreviations

3.1 Definitions

For the purposes of the present document, the terms and definitions given in 3GPP TS 44.060 and the following apply:

block period: sequence of timeslots on a SBPSCH or a DBPSCH used to convey one radio block.

There are 4 timeslots in this sequence for PDTCH, PACCH, SACCH, SDCCH, TCH/AHS, E-FACCH. There are 6 timeslots in this sequence for FACCH/H. There are 8 timeslots in this sequence for TCH/AFS and FACCH/F. There are 22 timeslots in this sequence for (E-)TCH/F.

DCCH TBF mode: refers to a TBF mapped onto a FACCH, SACCH or SDCCH.

radio block: sequence of normal bursts carrying one RLC/MAC protocol data unit (see 3GPP TS 44.004).

(The one exception is a radio block occasionally used on PACCH consisting of a sequence of four access bursts, each carrying a repetition of one short RLC/MAC block.). There are 4 normal bursts in this sequence for PDTCH, PACCH, SACCH, SDCCH, TCH/AHS, E-FACCH. There are 6 normal bursts in this sequence for FACCH/H. There are 8 normal bursts in this sequence for TCH/AFS and FACCH/F. There are 22 normal bursts in this sequence for (E-)TCH/F.

RLC non-transparent mode: refers to either RLC acknowledged mode or RLC unacknowledged mode.

TCH TBF mode: refers to a TBF mapped onto a TCH.

NOTE: *Iu mode* specific definitions that are not used in 3GPP TS 44.060 should be added here.

3.2 Symbols

For the purposes of the present document, the following symbols apply:

<i>A</i>	Interface between a BSS and a 2G MSC
<i>Gb</i>	Interface between a BSS and a 2G SGSN
<i>Iu</i>	Interface between a BSS or an RNC and a 3G MSC or a 3G SGSN
<i>Iu-cs</i>	Interface between a BSS or an RNC and a 3G MSC
<i>Iu-ps</i>	Interface between a BSS or an RNC and a 3G SGSN
<i>Um</i>	Interface between an MS and the GERAN

3.3 Abbreviations

For the purposes of the present document, the abbreviations given in 3GPP TR 21.905 and 3GPP TS 43.064, and the following apply:

ARQ	Automatic Repeat reQuest
BCCH	Broadcast Control CHannel
BSS	Base Station Subsystem
CBCH	Cell Broadcast CHannel
CCN	Cell Change Notification
CN	Core Network
CS- <i>i</i>	GPRS Coding Scheme <i>i</i>
DBPSCH	Dedicated Basic Physical Sub CHannel
ECSD	Enhanced Circuit Switched Data
EDGE	Enhanced Data rates for Global Evolution
EGPRS	Enhanced General Packet Radio Service
FACCH	Fast Associated Control CHannel
GERAN	GSM/EDGE Radio Access Network
GPRS	General Packet Radio Service
GRA	GERAN Registration Area
G-RNTI	GERAN Radio Network Temporary Identity
GSM	Global System for Mobile communications
HFN	Hyper Frame Number
IMSI	International Mobile Subscriber Identity
LCS	LoCation Services
MAC	Medium Access Control
MCS- <i>i</i>	EGPRS Modulation and Coding Scheme <i>i</i>
MS	Mobile Station
MSC	Mobile Switching Centre
NAS	Non Access Stratum
NSAPI	Network-layer SAPI
NT-RLC	RLC non-transparent mode
PBCCH	Packet BCCH
PDCH	Packet Data CHannel
PDCP	Packet Data Convergence Protocol
PDP	Packet Data Protocol
PDTCH	Packet Data TCH
PDU	Protocol Data Unit
PLMN	Public Land Mobile Network
PTCCH	Packet Timing-advance Control CHannel
P-TMSI	Packet TMSI
QoS	Quality of Service
RB	Radio Bearer
RBid	Radio bearer identity
RLC	Radio Link Control
RNC	Radio Network Controller
RR	Radio Resource
RRBid	Reduced RBid
RRC	Radio Resource Control
SACCH	Slow Associated Control CHannel

SAP	Service Access Point
SAPI	Service Access Point Identifier
SBPSCH	Shared Basic Physical Sub CHannel
SDCCH	Stand-alone Dedicated Control CHannel
SDU	Service Data Unit
SGSN	Serving GPRS Support Node
SRB	Signalling Radio Bearer
TBF	Temporary Block Flow
TCH	Traffic Channel
TMSI	Temporary Mobile Subscriber Identity
T-RLC	RLC transparent mode
UMTS	Universal Mobile Telecommunication System
URB	User Radio Bearer
USF	Uplink State Flag
UTRAN	UMTS Terrestrial Radio Access Network

4 Layered overview of radio interface

The protocol architecture for the radio interface is shown in figure 4.1.

The RLC/MAC function provides a service to PDCP for User plane data, to RRC for Control plane data and to the application layer of the CS User plane.

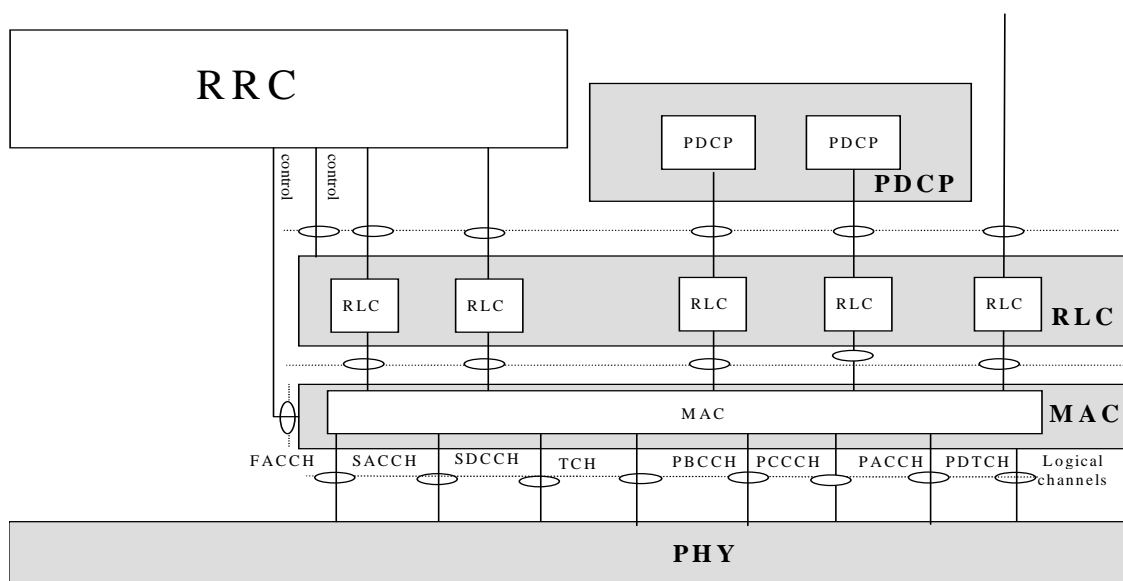

Figure 4.1: Radio Interface Protocol architecture

4.1 Layer services

The RLC/MAC sublayer provides services for the transfer over the physical layer between the network and mobile station of upper layer PDUs for one mobile station when operating on a dedicated basic physical subchannel, or for one or more mobile stations when operating on a shared basic physical subchannel.

The RLC function provides the following services to the upper layers:

- **Transparent data transfer:** This service transmits higher layer PDUs without adding any protocol information.
- **Acknowledged data transfer:** This service transmits higher layer PDUs and guarantees delivery to the peer entity.
- **Unacknowledged data transfer:** This service transmits higher layer PDUs without guaranteeing delivery to the peer entity.
- **Notification of unrecoverable errors:** RLC notifies the upper layer of errors that cannot be resolved by RLC itself by normal exception handling procedures.
- **Notification of discard:** RLC notifies the upper layer of the higher layer PDUs (RLC SDUs) it discards.
- **Suspend:** The RLC entity does not transmit any new RLC PDUs to the lower layer.
- **Resume:** The RLC entity resumes data transmission.
- **Stop:** The RLC entity does not transmit any RLC PDUs to the lower layer and does not receive any PDUs from the lower layer.
- **Continue:** The RLC entity resumes data transmission and reception.
- **Re-establishment:** The RLC entity is re-established.

The MAC function provides the following service to the upper layer:

- **Data transfer.**

4.2 Layer functions

4.2.1 RLC function

The functions provided by the RLC are given in table 4.2.1.1. Transparent RLC mode provides no functionality.

Table 4.2.1.1: RLC Functions

	Acknowledged mode RLC	Unacknowledged mode RLC	Transparent mode RLC
Segmentation of upper layer PDUs into RLC data blocks	X	X	
Concatenation of upper layer PDUs into RLC data blocks	X	X	
Padding to fill out RLC data block	X	X	
Backward Error Correction (BEC) procedure enabling the selective retransmission of RLC data blocks	X		
Discard of RLC SDUs not yet segmented into RLC PDUs, according to the delay requirements of the associated Radio Bearers	X		
Reassembly of RLC data blocks into upper layer PDUs	X	X	
In-sequence delivery of upper layer PDUs	X	X	
Link Adaptation	X	X	
Ciphering	X	X	
Sequence number check to detect lost RLC blocks	X	X	

4.2.2 MAC layer function

The functions of the MAC layer include:

- **Configuring the mapping between logical channels and basic physical subchannels:** The MAC layer is responsible for configuring the mapping of logical channel(s) onto the appropriate basic physical subchannel(s).
- **Selecting logical channels to be used for each signalling radio bearer service:** The MAC layer is responsible for mapping SRBs onto logical channels. There are a set of rules defined for this mapping (see sub-clause 5.6) which shall be used in the uplink and should be used in the downlink. The mapping is dependent on the SRB to be sent, the MAC state, and the logical channels available. The selection of the logical channel may depend on the number of RLC data blocks for the SRB being below a certain threshold. The SFACCH may be selected in preference to the PDTCH if a TBF is not already established for the SRB. In the downlink there is an additional requirement that the PHYSICAL INFORMATION message is always sent on the FACCH.
- **Selecting logical channels to be used for each user radio bearer service:** The logical channels used by the MAC for user radio bearers are set up by configuration from RRC.
- **Assignment, reconfiguration and release of shared radio resources for a TBF:** The MAC layer may handle the assignment of radio resources needed for a TBF including needs from both the control and user plane. The MAC layer may reconfigure radio resources of a TBF.
- **MS measurement reporting and control of the reporting:** The MAC layer is responsible for sending information that control the MS measurement reporting when using PBCCH or PACCH channels. The MAC layer also performs the reporting of the measurements from the MS to the network using PACCH.
- **Broadcasting/listening of/to PBCCH and PCCCH:** The MAC layer broadcasts/listens (to) the PBCCH of the serving cell for the sending/decoding of packet system information messages. The MAC layer also sends paging information on the PCCCH or and monitors the paging occasions according to the DRX cycle. Within the Mobile Station, the MAC layer notifies the RRC layer when receiving a paging message; within the network, it is responsible for aggregating and sending paging messages addressed to one or more Mobile Stations when received from the RRC layer.
- **Timing advance control:** The MAC layer controls the operation of timing advance on shared basic physical subchannels.
- **Ciphering and deciphering** (only in combination with transparent RLC mode).

When the MAC layer is providing services to a non-transparent RLC mode entity, the MAC layer supports the following additional functions:

- **Ciphering.**
- **Identification of different traffic flows of one or more MSs on the basic physical subchannels:** Inband identification is needed to address a flow to an MS in the downlink or identify a flow from an MS in the uplink.
- **Multiplexing/demultiplexing of higher layer PDUs:** This may include priority handling between data flows of one or more mobile stations, e.g. by attributes of Radio Bearer services.
- **Multiplexing/demultiplexing user and control plane data to/from the physical layer for PDTCHs:** The MAC layer is responsible for multiplexing/demultiplexing RLC data blocks carried on PDTCH and RLC/MAC control blocks carried on PACCH.
- **Scheduling of RLC/MAC data and control PDUs delivered to the physical layer on shared basic physical subchannels:** This includes USF and RRBP field monitoring for uplink transfer and sharing radio resources on the downlink.
- **Splitting/recombining:** This includes splitting/recombining of the RLC/MAC PDU flow belonging to one or more TBF(s) onto/from several shared logical channels. This function does not apply for RLC/MAC control blocks.

4.3 Service primitives

4.3.1 MAC to Physical Layer Primitives

These are defined in 3GPP TS 44.004.

4.3.2 PDCP to RLC Primitives

4.3.2.1 Primitives

The primitives between PDCP and RLC are shown in table 4.3.2.1.1.

Table 4.3.2.1.1: Primitives between RLC and upper layers

Generic Name	Parameters			
	Req.	Ind.	Resp.	Conf.
RLC-AM-DATA	Data, CNF, MUI	Data	Not Defined	Status, MUI
RLC-UM-DATA	Data	Data	Not Defined	Not Defined
RLC-TM-DATA	Data	Data, Error_Indicator	Not Defined	Not Defined

Each Primitive is defined as follows:

RLC-AM-DATA-Req/Ind/Conf

- RLC-AM-DATA-Req is used by upper layers to request transmission of an RLC SDU in acknowledged mode.
- RLC-AM-DATA-Ind is used by the AM RLC entity to deliver to upper layers an RLC SDU that has been transmitted in acknowledged mode.
- RLC-AM-DATA-Conf is used by the AM RLC entity to confirm to upper layers the reception of an RLC SDU by the peer-RLC AM entity or to inform the upper layers of a discarded RLC SDU.

RLC-UM-DATA-Req/Ind/Conf

- RLC-UM-DATA-Req is used by upper layers to request transmission of an RLC SDU in unacknowledged mode.
- RLC-UM-DATA-Ind is used by the UM RLC entity to deliver to upper layers an RLC SDU that has been transmitted in unacknowledged mode.

RLC-TM-DATA-Req/Ind/Conf

- RLC-TM-DATA-Req is used by upper layers to request transmission of an RLC SDU in transparent mode.
- RLC-TM-DATA-Ind is used by the TM RLC entity to deliver to upper layers an RLC SDU that has been transmitted in transparent mode.

4.3.2.2 Primitive parameters

The following parameters are used in the primitives:

- 1) The parameter Data is the RLC SDU that is mapped onto the Data field in RLC PDUs.
- 2) The parameter Confirmation Request (CNF) indicates whether the transmitting side of the AM RLC entity needs to confirm the reception of the RLC SDU by the peer-RLC AM entity. If required, once all AMD PDUs that make up the RLC SDU are positively acknowledged by the receiving AM RLC entity, the transmitting AM RLC entity notifies upper layers.
- 3) The parameter Message Unit Identifier (MUI) is an identity of the RLC SDU, which is used to indicate which RLC SDU that is confirmed with the RLC-AM-DATA-Conf. Primitive.
- 4) The Error_Indicator parameter indicates that the RLC SDU is erroneous.

- 5) The parameter Status is only applicable for AM operation. This parameter indicates whether a RLC SDU is successfully transmitted or discarded.

4.3.3 RRC to RLC Primitives

4.3.3.1 Primitives

The primitives between RRC and RLC are shown in table 4.3..3.1.

Table 4.3.3.1: Primitives between RRC and RLC

Generic Name	Parameters			
	Req.	Ind.	Resp.	Conf.
RLC-AM-DATA	Data, CNF, MUI, DiscardReq	Data	Not Defined	Status, MUI
RLC-UM-DATA	Data	Data	Not Defined	Not Defined
CRLC-CONFIG	E/R, Stop (UM/AM only), Continue (UM/AM only), Ciphering Elements (UM/AM only), TM_parameters (TM only), UM_parameters (UM only-SDU discard, EGPRS window size), AM_parameters (AM only –SDU discard, resegment bit, EGPRS window size)	Not Defined	Not Defined	Not Defined
CRLC-SUSPEND (UM/AM only)	N	Not Defined	Not Defined	V(S) (AM/UM only)
CRLC-RESUME (UM/AM only)	No Parameter	Not Defined	Not Defined	Not Defined

Each Primitive is defined as follows:

RLC-AM-DATA-Req/Ind/Conf

- RLC-AM-DATA-Req is used by upper layers to request transmission of an RLC SDU in acknowledged mode.
- RLC-AM-DATA-Ind is used by the AM RLC entity to deliver to upper layers an RLC SDU that has been transmitted in acknowledged mode.
- RLC-AM-DATA-Conf is used by the AM RLC entity to confirm to upper layers the reception of an RLC SDU by the peer-RLC AM entity.

RLC-UM-DATA-Req/Ind/Conf

- RLC-UM-DATA-Req is used by upper layers to request transmission of an RLC SDU in unacknowledged mode.
- RLC-UM-DATA-Ind is used by the UM RLC entity to deliver to upper layers an RLC SDU that has been transmitted in unacknowledged mode.

CRLC-CONFIG-Req

This primitive is used by upper layers to establish, re-establish, release, stop, continue or modify the RLC. Ciphering elements are included for UM and AM operation.

CRLC-SUSPEND-Req/Conf

- CRLC-SUSPEND-Req is used by upper layers to suspend the UM or AM RLC entity.
- CRLC-SUSPEND-Conf is used by the UM or AM RLC entity to confirm that the entity is suspended.

CRLC-RESUME-Req

This primitive is used by upper layers to resume the UM or AM RLC entity after the UM or AM RLC entity has been suspended.

4.3.3.2 Primitive parameters

Following parameters are used in the primitives:

- 1) The parameter Data is the RLC SDU that is mapped onto the Data field in RLC PDUs.
- 2) The parameter Confirmation Request (CNF) indicates whether the transmitting side of the AM RLC entity needs to confirm the reception of the RLC SDU by the peer-RLC AM entity. If required, once all AMD PDUs that make up the RLC SDU are positively acknowledged by the receiving AM RLC entity, the transmitting AM RLC entity notifies upper layers.
- 3) The parameter Message Unit Identifier (MUI) is an identity of the RLC SDU, which is used to indicate which RLC SDU that is confirmed with the RLC-AM-DATA-Conf. Primitive.
- 4) The parameter E/R indicates establishment, re-establishment, release or modification of an RLC entity, where re-establishment is applicable to AM and UM RLC entities only.
- 5) The parameter Ciphering Elements are only applicable for UM and AM operations. These parameters are Ciphering Key, Activation Time (Sequence Number (BSN) to activate a new ciphering configuration) and HFN (Hyper Frame Number).
- 6) The AM_parameters are only applicable for AM operation.
- 7) The Stop parameter is applicable to AM and UM RLC entities only and indicates to the RLC entity to not transmit nor receive any RLC PDUs.
- 8) The Continue parameter is applicable to AM and UM RLC entities only and indicates to the RLC entity to continue transmission and reception of RLC PDUs.
- 9) The UM_parameters are only applicable for UM operation.
- 10) The TM_parameters are only applicable for TM operation.
- 11) The N parameter indicates that an RLC entity will not send a PDU with "Sequence Number" $\geq V(S)+N$ for UM/AM RLC entities where N is a non-negative integer.
- 12) The V(S) parameter indicates the value of the Send State Variable for the case of the AM/UM RLC entities.
- 13) The parameter Status is only applicable for AM operation. This parameter indicates whether a RLC SDU is successfully transmitted or discarded.
- 14) The parameter DiscardReq indicates whether the transmitting RLC entity needs to inform the upper layers of the discarded RLC SDU. If required, the transmitting RLC entity notifies upper layers when the RLC SDU is discarded..

4.3.4 RRC to MAC Primitives

4.3.4.1 Primitives

The primitives between MAC and RRC are shown in table 4.3.4.1.

Table 4.3.4.1: Primitives between RRC sub-layer and MAC

Generic Name	Parameter			
	Request	Indication	Response	Confirm
CMAC-CONFIG	MS information elements, RB information elements, Ciphering elements,			
CMAC-SYS-INFO	System Information Elements			
PAGING	MS Identity, CN Domain Identity, Paging Cause, Paging Record Type Identifier	MS Identity, CN Domain Identity, Paging Cause, Paging Record Type Identifier	NA	NA
HANDOVER	Handover Reference Value	Handover Reference Value	NA	NA
PHYSICAL-INFO	Timing Advance Value	Timing Advance Value	NA	NA

CMAC-CONFIG-Req

- CMAC-CONFIG-Req is used to request for setup, release and configuration of a logical channel. G-RNTI allocation, mapping between radio bearer and logical channel.

CMAC-SYS-INFO-Req

- CMAC-SYS-INFO-Req is used to pass information elements needed for the generation of system information messages within the MAC entity.

PAGING-Req/Ind:

- PAGING-Req is used by RRC to page a MS.
- PAGING-Ind is used by the MS to inform the RRC of the reception of a PACKET PAGING REQUEST message.

HANDOVER-Req/Ind:

- HANDOVER-Req is used by the mobile station's RRC to trigger the transmission of the HANDOVER ACCESS message to the network
- HANDOVER-Ind is used by the network to inform the RRC of the reception of a HANDOVER ACCESS message

PHYSICAL-INFO-Req/Ind:

- PHYSICAL-INFO-Req is used by the network's RRC to trigger the transmission of the PHYSICAL INFORMATION message to the mobile station
- PHYSICAL-INFO-Ind is used by the mobile station to inform the RRC of the reception of the PHYSICAL INFORMATION message

4.3.4.2 Primitive Parameters

The MAC configuration primitives use the following parameters. See 3GPP TS 44.118 for a detailed description of the MS, and RB information elements.

- 1) MS information elements
 - G-RNTI
 - SRNC identity
 - Activation time
- 2) RB information elements
 - RB multiplexing info (Logical channel identity, radio priority, mapping of reduced radio bearer id to radio bearer id)
- 3) Ciphering elements
 - Ciphering key
 - Activation Time (TDMA Frame Number) HFN

The system information primitives use the following parameter:

- 1) System Information elements
See 3GPP TS 44.118

The paging primitives use the following parameters:

- 1) The *MS Identity* parameter is the IMSI, TMSI, PTMSI, or G-RNTI.
- 2) The *CN Domain Identity* parameter indicates whether a CN-initiated page is from the packet domain or circuit domain.
- 3) The *Paging Cause* parameter indicates the reason for the page.
- 4) The *Paging Record Type Identifier* parameter indicates the type of MS identity used by the CN in a CN-initiated page, e.g. IMSI (GSM), IMSI (DS-41), TMSI/PTMSI (GSM).

The handover primitives use the following parameter:

- 1) The *Handover Reference Value* parameter indicates the handover reference value used for access identification in the HANDOVER ACCESS message

The physical info primitives use the following parameter:

- 1) The *Timing Advance Value* parameter indicates the timing advance value in the PHYSICAL INFORMATION message to be applied by the mobile station

4.4 Services required from lower layers

The RLC/MAC function uses the services provided by the physical link layer as defined in 3GPP TS 44.004.

The following services are required of the physical layer:

- **Access capabilities:** The physical layer offers logical channels and the transmission services associated to higher layers. Logical channels are multiplexed either in a fixed predefined manner (multiframe structure) or dynamically by the MAC layer on basic physical subchannels. Basic physical subchannels are the units scheduled on the radio medium. Some are reserved by the network for common use (e.g. for use by a combination of CCCH and BCCH), others are assigned to dedicated connections with MSs (dedicated basic physical subchannels), or are assigned to a shared usage between MSs (shared basic physical subchannels).
- **Error detection:** The physical layer offers an error protected transmission service, it includes error detection functions and to a lower level, error correction functions. Erroneous received frames may be notified to upper layers and, depending on the need of the upper layer, offered to it. The probability of one or more errors in a physical block transferred by the physical layer is defined in 3GPP TS 45.005. Due to non-specified methods of quality detection, the probability of residual errors in transferred blocks may vary between implementations.
- **Measurement of the signal strength of neighbouring base stations.** Measurements are transferred to RRC.
- **Measurement of the signal quality of the basic physical subchannel used.** Measurements are transferred to the MAC layer for reporting to the base station.
- **Cell/PLMN selection in MAC-Idle state.** In MAC-Idle state the physical layer selects the best cell with its BCCH in close co-operation with layer 3, meeting requirements for PLMN selection specified in 3GPP TS 42.011.

5 Introduction to the Medium Access Control (MAC) procedures

5.1 General

The Medium Access Control procedures include the functions related to the management of the shared transmission resources (e.g. the packet data physical channels and the radio link connections on packet data physical channels) and dedicated transmission resources (e.g. the multiplexing of logical channels onto DBPSCHs).

The Medium Access Control procedures support the provision of Temporary Block Flows that allow the point-to-point transfer of signalling and user data within a cell between the network and a mobile station.

Moreover, the Medium Access Control procedures include the procedures for reception of PBCCH and PCCCH, which permits autonomous cell reselection performed by the mobile station (see 3GPP TS 45.008).

5.2 Multiplexing principles

5.2.1 Temporary Block Flow

A TBF is a logical connection used by two MAC entities to support the unidirectional transfer of upper-layer PDUs on basic physical sub-channels. A mobile station shall support eight TBFs in each direction (uplink and downlink). The network shall not assign more than eight TBFs to a mobile station. The total amount of TBFs assigned to a mobile station in a given direction shall always be lower than or equal to eight.

The TBF is allocated radio resources on one or more BPSCHs of the same type (i.e. either SBPSCH(s) or DBPSCH(s)) and may only be mapped on one logical channel type at a time. A TBF shall not be mapped on more than one DBPSCH/S. The TBF comprises a number of RLC/MAC blocks carrying one or more upper-layer PDUs.

A TBF mapped on PDTCH(s) may operate in either GPRS TBF mode or EGPRS TBF mode. If this TBF is operating on SBPSCH(s), the network sets the TBF mode in the PACKET UPLINK ASSIGNMENT message, MULTIPLE TBF UPLINK ASSIGNMENT message, PACKET DOWNLINK ASSIGNMENT message, MULTIPLE TBF DOWNLINK ASSIGNMENT message, PACKET TIMESLOT RECONFIGURE message, MULTIPLE TBF TIMESLOT RECONFIGURE message. If this TBF is operating on DBPSCH(s), the network sets the TBF mode using RRC procedures (see 3GPP TS 44.118). The EGPRS TBF mode is only supported by EGPRS capable MSs.

A TBF mapped on FACCH, SACCH or SDCCH operates implicitly in DCCH TBF mode.

A TBF mapped on TCH operates implicitly in TCH TBF mode.

A TBF associated with a URB may operate in either GPRS TBF mode, EGPRS TBF mode, DCCH TBF mode or TCH TBF mode.

A TBF associated with a SRB may operate in either GPRS TBF mode (CS-1 coding only) or DCCH TBF mode. It shall not operate in EGPRS TBF mode.

5.2.2 Temporary Flow Identity

5.2.2.1 Temporary Flow Identity for SBPSCH

See 3GPP TS 44.060 sub-clause 5.2.2.

Global_TFI is used in an uplink or a downlink RLC/MAC control message to unambiguously identify the mobile station or one of its TBFs on SBPSCH. If present, the Global TFI addresses the mobile station using either an uplink TFI or a downlink TFI. The TFI used shall obey the rules below:

- If the TFI is used to identify the mobile station, any TFI may be used provided:

- The timeslot number (TN) of the SBPSCH on which the RLC/MAC control message is sent corresponds to a timeslot assigned to the TBF in the direction of the TBF.
- If the TFI is used to identify a TBF, the TFI of this TBF shall be used. Additionally if the RLC/MAC control message is sent in uplink, and the TBF is a downlink TBF:
 - If the timeslot number (TN) of the SBPSCH on which the RLC/MAC control message is sent does not correspond to any of the timeslots assigned to the TBF in the direction of the TBF, the TN of the TBF shall be included in the RLC/MAC control message to uniquely identify this TBF.

5.2.2.2 Temporary Flow Identity for DBPSCH

A TBF mapped on DBPSCH(s) may operate in either GPRS, EGPRS, DCCH or TCH TBF mode. A TBF mapped on DBPSCH/S shall operate in DCCH TBF mode.

A TBF in either GPRS TBF mode, EGPRS TBF mode is implicitly assigned a TFI that equals the identity (RBI) of the radio bearer it carries. An RLC/MAC block associated with such TBF shall contain a TFI. The TBF to which a RLC data block belongs is identified by the TFI and the direction (uplink or downlink) in which this RLC data block is sent. The TBF to which a RLC/MAC control message belongs is identified by the TFI, the direction in which this RLC/MAC control message is sent and the message type.

A TBF in TCH TBF mode is not assigned a TFI. This TBF is in its direction the only user of the TCH on which it is mapped, as described in sub-clause 9.2.2.

A TBF in DCCH TBF mode is implicitly assigned a Reduced Radio Bearer identity (RRBI) that provides a one-to-one mapping with the RBI of the radio bearer it carries. In case this radio bearer is a User-plane Radio Bearer (URB), the mapping between RRBI and RBI is given at radio bearer set-up of this URB by means of primitive exchange between RRC and MAC (CMAC-CONFIG). An RLC/MAC block associated with a DCCH TBF mode shall contain a RRBI. The TBF to which a RLC data block belongs is identified by the RRBI and the direction (uplink or downlink) in which this RLC data block is sent. The TBF to which a RLC/MAC control message belongs is identified by the RRBI, the direction in which this RLC/MAC control message is sent and the message type.

5.2.3 Uplink State Flag

See 3GPP TS 44.060 sub-clause 5.2.3.

5.2.4 Medium Access modes

5.2.4.1 Medium Access modes for SBPSCH

See 3GPP TS 44.060 sub-clause 5.2.4.

5.2.4.2 Medium Access modes for DBPSCH

The dedicated allocation is applicable exclusively on a dedicated channel (i.e. mapped onto a DBPSCH). No other MAC mode may apply on DBPSCH. If the mobile station is assigned a DBPSCH (e.g. PACKET DBPSCH ASSIGNMENT), dedicated allocation shall be used in both uplink and downlink directions on this DBPSCH.

5.2.5 Multiplexing of GPRS and EGPRS TBF mode capable mobile stations

See 3GPP TS 44.060 sub-clause 5.2.4a.

5.3 MAC States

5.3.1 MAC-Idle state

5.3.1.1 General

In MAC-Idle state no TBF exists and the mobile station monitors relevant paging subchannels on the PCCCH. The mobile station may use DRX for monitoring the PCCCH.

5.3.1.2 Establishment of a SBPSCH

In MAC-Idle state, upper layers may require the transfer of an upper-layer PDU, which may trigger the establishment of a TBF on SBPSCH(s) and the transition to MAC-Shared state.

5.3.1.3 Establishment of a DBPSCH

In MAC-Idle state upper layers may require the transfer of an upper-layer PDU, which may trigger the establishment of a TBF on DBPSCH(s) either through RRC procedures (see 3GPP TS 44.118) or RLC/MAC procedures, in which case the mobile station leaves MAC-Idle state and enters the MAC-Dedicated state immediately after assignment of the DBPSCH(s). A mobile station shall not be assigned more than one DBPSCH/S.

5.3.2 MAC-Shared state

5.3.2.1 General

In MAC-Shared state, the mobile station is allocated radio resources providing a TBF for a point-to-point connection on one or more SBPSCHs. The TBF is used for the unidirectional transfer of upper-layer PDUs between the network and the mobile station. In MAC-Shared state the following services are offered:

- transfer of upper-layer PDUs in RLC acknowledged mode;
- transfer of upper-layer PDUs in RLC unacknowledged mode.

5.3.2.2 Release of all SBPSCHs

In MAC-Shared state, when all TBFs have been released in the downlink and uplink direction, the mobile station returns to MAC-Idle state.

5.3.2.3 Establishment of a DBPSCH

In MAC-Shared state upper layers may require the transfer of an upper-layer PDU, which may trigger the establishment of a TBF on a DBPSCH through RRC procedures (see 3GPP TS 44.118), in which case the mobile station leaves MAC-Shared state and enters the MAC-DTM state.

5.3.2.4 Radio bearer reconfiguration

Upon reconfiguration of all Radio Bearers from SBPSCH(s) to DBPSCH(s), the mobile station shall leave the MAC-Shared state and enter the MAC-Dedicated state after release of all TBFs on SBPSCH(s) and set-up of the first DBPSCH. See 3GPP TS 44.118.

5.3.3 MAC-DTM state

5.3.3.1 General

In MAC-DTM state a mobile station has been allocated radio resources providing one or more DBPSCHs and one or more SBPSCHs. A mobile station shall not be allocated radio resources providing a DBPSCH/S with any other

BPSCH(s). The allocation of radio resources is co-ordinated by the network, in agreement with the capabilities of the mobile station.

The transfer of upper-layer PDUs in RLC acknowledged, RLC unacknowledged mode or RLC transparent mode is provided.

5.3.3.2 Release of all SBPSCHs

In MAC-DTM state, when all TBFs on SBPSCHs have been released, in downlink and uplink directions, the mobile station enters MAC-Dedicated state.

5.3.3.3 Release of all DBPSCHs

In MAC-DTM state, upon release of all DBPSCHs, the mobile station enters the MAC-Shared state.

5.3.3.4 Release of all SBPSCHs and DBPSCHs

In MAC-DTM state, upon release of all SBPSCHs and DBPSCHs, the mobile station enters the MAC-Idle state.

5.3.4 MAC-Dedicated state

5.3.4.1 General

In MAC-Dedicated state a mobile station has been allocated radio resources providing one or more DBPSCHs. A mobile station shall not be allocated more than one DBPSCH/S. The allocation of radio resources is co-ordinated by the network, in agreement with the capabilities of the mobile station.

The transfer of upper-layer PDUs in RLC acknowledged, RLC unacknowledged mode or RLC transparent mode is provided.

5.3.4.2 Release of all DBPSCHs

In MAC-Dedicated state, upon release of all DBPSCHs, the mobile station shall enter the MAC-Idle state.

5.3.4.3 Radio bearer reconfiguration

Upon reconfiguration of all Radio Bearers from DBPSCH(s) to SBPSCH(s), the mobile station shall leave the MAC-Dedicated state and enter the MAC-Shared state after release of all DBPSCH(s) and set-up of the first TBF on SBPSCH(s) (see 3GPP TS 44.118).

5.3.5 MAC state machine

Figure 5.3.5.1 represents the state machine of the MAC sublayer.

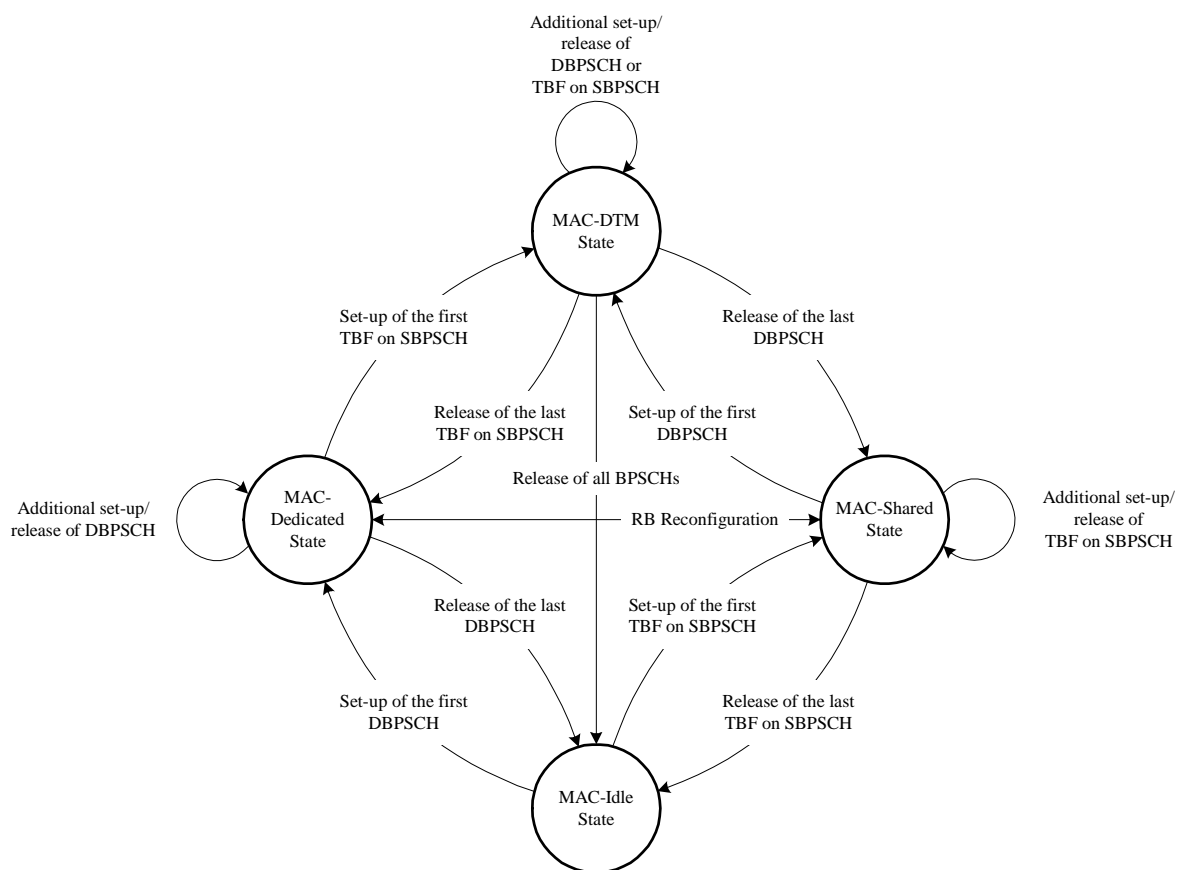

Figure 5.3.5.1: MAC state machine

5.4 General MAC procedures in MAC-Idle state and MAC-Shared state

5.4.1 Mobile station side

5.4.1.1 General

A mobile station in MAC-Idle state or MAC-Shared state shall monitor the system information broadcast in the cell.

In MAC-Idle state, the mobile station shall monitor the radio blocks on PCCCH as defined in sub-clauses 5.4.1.8 and 5.4.1.9. The determination of the paging group for the mobile station is defined in 3GPP TS 45.002.

5.4.1.2 Cell reselection

Cell reselection in MAC-Idle state and MAC-Shared state is specified in 3GPP TS 45.008. The MAC entity on the mobile station side indicates to the RRC layer the availability of a cell and a cell change when decided by the MAC sublayer. RRC is advised of system information broadcast in the cell when a new cell has been selected or when a relevant part of this information changes.

If the new cell supports *Iu mode* the mobile station shall operate in *Iu mode* unless ordered to operate in *A/Gb mode* by the network. If the new cell does not support *Iu mode*, a mobile station which supports *A/Gb mode* shall operate in *A/Gb mode* as described in 3GPP TS 44.060. If operating in *Iu mode*, the mobile station shall perform packet access in *Iu mode* otherwise the mobile station shall perform packet access in *A/Gb mode*.

When a cell reselection is determined by the mobile station or ordered by the network, the mobile station may continue its operation in MAC-Idle state or MAC-Shared state in the old serving cell, while acquiring certain system information for the target cell.

If the old cell does not support CCN, the operation in the old cell shall be aborted when one of the following conditions are met:

- the mobile station starts to receive information on PBCCH in the target cell;
- the mobile station has received the SI13 message (see 3GPP TS 44.018) and there is no PBCCH present in the target cell; or
- the criteria for camping on the old cell are no longer fulfilled (see 3GPP TS 45.008).

If PBCCH is present in the target cell, the mobile station shall delay the start of receiving information on PBCCH until the first occurrence of PSI1 in block B0. If the reception of PSI1 or PSI2 messages fails (see sub-clause 5.4.1.5) the mobile station may re-establish and continue its operation in the old cell, until the next occurrence of PSI1 in block B0.

While the operation is maintained in the old cell, the mobile station may suspend its TBF(s) or suspend the monitoring of radio blocks on PCCCH, in order to receive necessary information on BCCH in the target cell. Such suspension may be required in MAC-Idle state and MAC-Shared state. It is performed without notification to the network.

Suspension of the operation in the old cell for this purpose is allowed during the time required, for each message and according to the mobile station's multislot class, to receive the required messages on BCCH in the target cell. The allowable suspension of an uplink TBF may be extended with one block period, in case of dynamic or extended dynamic allocation, if the mobile station is unable to receive the corresponding USF due to the suspension of downlink operation.

When the conditions are fulfilled to switch to the new cell, the mobile station shall abort any TBF in progress by immediately ceasing to decode the downlink, ceasing to transmit on the uplink, stopping all RLC/MAC timers except for timers related to measurement reporting. The mobile station shall then switch to the identified specified new cell and shall obey the relevant RLC/MAC procedures on this new cell.

If the old cell supports CCN, a mobile station shall, when the cell reselection has been determined, follow the procedures for Network Assisted Cell Change as specified in 3GPP TS 44.060 sub-clauses 5.5.1.1a.2 and 8.8.2.

Under no circumstances and independent of whether CCN mode is supported, operations in the old cell shall be continued more than 5 seconds after a cell reselection has been determined.

5.4.1.3 Network Assisted Cell Change

See 3GPP TS 44.060 sub-clause 5.5.1.1a.

5.4.1.4 Release of DBPSCHs

5.4.1.4.1 General

The mobile station shall acquire system information broadcast in the serving cell when in MAC-Idle state, after the release of all DBPSCHs if the mobile station had been unable to monitor the system information broadcast on PBCCH while one or more DBPSCHs were allocated:

- The acquisition of system information shall be performed according to the requirements in sub-clause 5.4.1.5.
- The mobile station shall not attempt a packet access or accept a packet downlink assignment before these requirements are fulfilled.

The following exceptions, stated in sub-clauses 5.4.1.4.2 and 5.4.1.4.3, may apply.

5.4.1.4.2 Continuation of PBCCH information

At the allocation of a DBPSCH, the mobile station may keep the PSI messages received on PBCCH before the allocation of the DBPSCH. If all DBPSCHs are released in the same serving cell within 30 s after the PSI1 message was last received, the mobile station may resume the supervision of PBCCH_CHANGE_MARK and update of PBCCH information, defined in 3GPP TS 44.060 sub-clause 5.5.1.2.1, and need not initiate a *complete acquisition* of PBCCH information, as specified in sub-clause 5.4.1.5.

5.4.1.4.3 Receipt of PSI14 message in MAC-DTM state

In MAC-DTM state, the mobile station may receive the PSI14 message on PACCH in the serving cell. If all DBPSCHs are released in the same serving cell within 30 s after the PSI14 message was last received, the mobile station may use the PSI14 message as a substitute for the SI13 or SI13-Alt message after the release of all DBPSCHs, until either the SI13 or SI13-Alt message has been received or the mobile station starts to receive information on PBCCH.

The presence of a PBCCH in the cell is indicated by a PBCCH description in the PSI14 message. If the message does not contain the PBCCH description, the mobile station shall assume that PBCCH is not present in the cell.

After the release of all of DBPSCHs, the mobile station shall perform a *complete acquisition* of PBCCH information, as defined in sub-clause 5.4.1.5.

5.4.1.5 System information on PBCCH

See 3GPP TS 44.060 sub-clause 5.5.1.2.

5.4.1.6 System information on BCCH

5.4.1.6.1 General

The support of *Iu mode* shall be indicated in SI3 message sent on BCCH. In addition, the support of *Iu mode* shall be indicated in either SI4 or SI7 and 8 messages. The SI3, SI4, SI7 and SI8 messages contain the CBQ3 parameter that indicates if *Iu mode* is supported in the cell (see 3GPP TS 44.018).

If CBQ3 parameter sent on BCCH indicates that *Iu mode* is supported in the cell then a mobile station shall acquire a PBCCH description from either SI13 or SI13-Alt and shall operate in *Iu mode* (see 3GPP TS 44.118).

If CBQ3 indicates that *Iu mode* is not supported in the cell then a mobile station may operate in *A/Gb mode* as described in 3GPP TS 44.060.

When a new cell has been selected where PBCCH is not present, the mobile station shall operate as described in 3GPP TS 44.060.

5.4.1.6.2 Establishment of PBCCH

The mobile station may receive an SI13, SI13-Alt or PSI13 message providing a PBCCH description indicating that PBCCH is present in the cell. The mobile station shall then perform a *complete acquisition* of PBCCH messages using the indicated PBCCH (see sub-clause 5.4.1.7).

5.4.1.6.3 (void)

5.4.1.7 (void)

5.4.1.8 Discontinuous reception (DRX)

A mobile station in MAC-Idle state may use Discontinuous Reception (DRX) to reduce its power consumption.

In DRX mode, the MAC layer receives the paging group relevant for the mobile station from the RRC layer via the CMAC-CONFIG primitive. The computation of the paging group is defined in 3GPP TS 44.118. The mobile station shall only monitor the blocks corresponding to its paging group. The GERAN shall initiate paging procedures for this mobile station on the blocks corresponding to its paging group.

In non-DRX mode, the mobile station shall monitor all paging blocks on the monitored PCCCH (see 3GPP TS 45.002).

There are three cases when the mobile station enters a non-DRX mode period:

- 1) When entering the MAC-Idle state, the mobile station shall enter the non-DRX mode period.

The duration of the non-DRX mode period is determined by the value of the DRX_TIMER_MAX parameter broadcast in the cell.

If the mobile station receives a new value of the DRX_TIMER_MAX parameter during the non-DRX mode period, the mobile station may wait to apply the new value until the next time the non-DRX mode period is entered.

- 2) When the network operates in NC2 mode and the MS sends a NC measurement report, both the MS and the network shall enter the NC2 non-DRX mode period. The duration of this period is defined by the NC_NON_DRX_PERIOD parameter.
- 3) When initiating the MM procedures for GPRS attach and routing area update defined in 3GPP TS 24.008, the mobile station shall enter the MM non-DRX mode period. This period ends when either of the messages GPRS ATTACH ACCEPT, GPRS ATTACH REJECT, ROUTING AREA UPDATE ACCEPT or ROUTING AREA UPDATE REJECT is received by the mobile station. This period also ends after timeout when waiting for any of these messages.

The non-DRX mode periods defined above run independent of each other and may overlap. In RRC-Idle mode, the mobile station shall be in non-DRX mode during any of the non-DRX mode periods.

5.4.1.9 Page mode procedures on PCCCH

See 3GPP TS 44.060 sub-clause 5.5.1.6.

5.4.1.10 Frequency Parameters

See 3GPP TS 44.060 sub-clause 5.5.1.7.

5.4.1.11 G-RNTI Management

G-RNTI is used to identify a mobile station during contention resolution and is allocated by RRC in the GERAN. If a mobile station does not possess a GERAN allocated G-RNTI when making a contention access it shall use a Random G-RNTI. Upon receiving a G-RNTI allocation from the GERAN a mobile station shall use it for subsequent contention accesses for as long as it remains valid.

5.4.2 Network side

5.4.2.1 System Information broadcasting

5.4.2.1.1 System information on PBCCH

If PBCCH is present in the cell, the network regularly broadcasts PACKET SYSTEM INFORMATION TYPE (PSI) 1, 2, 3, 3bis and PSI16 messages, and optionally PSI3ter, PSI3quater and some types of PSI messages on the PBCCH. The PSI 2, PSI 3bis, PSI3 ter, PSI3quater messages and some further types of PSI messages may be broadcast in multiple number of instances. Based on the information broadcast in PSI messages, a mobile station is able to decide whether and how it may gain access to the system via the current cell.

NOTE: The network should take into account the limitations of earlier version of mobile equipments to understand the 3-digit MNC format of the location area identification, see 3GPP TS 44.060 sub-clause 12.23 and 3GPP TS 44.018, table "Location Area Identification information element".

Instances of the PSI 4 message are broadcast on PBCCH if the mobile stations camping on the cell shall perform interference measurements for power control (see 3GPP TS 45.008).

Instances of the PSI 5 message are broadcast on PBCCH if the mobile stations camping on the cell shall perform measurement reporting (see 3GPP TS 45.008).

Instances of the PSI6 and PSI7 message may be broadcast on the PBCCH if non-GSM broadcast information is transmitted.

The PSI8 message may be broadcast on the PBCCH if additional information (i.e. CBCH configuration and dynamic ARFCN mapping) shall be provided to the mobile station camping on the cell.

The PSI16 message shall be broadcast on the PBCCH to provide mobile stations with additional information required for *Iu mode* operation.

The PSI1 message contains the PBCCH_CHANGE_MARK and PSI_CHANGE_FIELD parameters. The value of the PBCCH_CHANGE_MARK may be incremented by one, modulo 8, each time the network makes a change in the PBCCH information. Such change includes any addition, removal or replacement of PSI messages, contents of PSI messages, or change in the scheduling of PSI messages on PBCCH. A change in the contents of the PSI1 message alone shall not be reflected in the PBCCH_CHANGE_MARK. When the PBCCH_CHANGE_MARK is incremented, the PSI_CHANGE_FIELD parameter shall be set to an appropriate value to indicate the nature of the latest change in the PBCCH information.

The network may increment the PBCCH_CHANGE_MARK value by more than one, modulo 8, in order to enforce a complete acquisition of PBCCH information of all mobile stations.

In order to avoid extensive TBF suspensions following an increment of the PBCCH_CHANGE_MARK parameter, the network may send PSI messages on PACCH to mobile stations in MAC-Shared state.

The network indicates the support of the PACKET PSI STATUS and EGPRS PACKET CHANNEL REQUEST messages in the PSI1 message.

5.4.2.1.2 System information on BCCH

In addition to the requirements in 3GPP TS 44.018, a SYSTEM INFORMATION TYPE 13 (SI13) message or a SYSTEM INFORMATION TYPE 13 Alt (SI13-Alt) message is regularly broadcast by the network on the BCCH to support *Iu mode*. Note that either the SI13 message or the SI13-Alt message is required on BCCH to support *Iu mode*.

5.4.2.1.3 System information on PACCH (and other logical channels)

See 3GPP TS 44.060 sub-clause 5.5.2.1.3.

5.4.2.1.4 Consistent sets of system information messages

Certain types of PSI messages are sent on PBCCH in a multiple number of instances. If such a PSI message type is sent on (P)BCCH, a mobile station shall receive a consistent set of that type of PSI message. In some cases, more than one type of PSI messages may be joined into one consistent set, see table 5.4.2.1.4.1.

Table 5.4.2.1.4.1: Consistent sets of system information messages

Consistent set / Message Type(s)	Broadcast Channel	Number of instances	PSI change mark parameter	PSI index parameter	PSI count parameter
PSI2	PBCCH	1 – 8	PSI2_CHANGE_MARK	PSI2_INDEX	PSI2_COUNT
PSI3	PBCCH	1	PSI3_CHANGE_MARK		
PSI3 bis	PBCCH	1 – 16	PSI3_CHANGE_MARK	PSI3bis_INDEX	PSI3bis_COUNT
PSI3 ter	PBCCH	0 – 16	PSI3_CHANGE_MARK	PSI3ter_INDEX	PSI3ter_COUNT
PSI3 quater	PBCCH	0 – 16	PSI3_CHANGE_MARK	PSI3quater_INDEX	PSI3quater_COUNT
PSI4	PBCCH	0 – 8	PSI4_CHANGE_MARK	PSI4_INDEX	PSI4_COUNT
PSI5	PBCCH	0 – 8	PSI5_CHANGE_MARK	PSI5_INDEX	PSI5_COUNT
PSI6	PBCCH	0 – 8	PSI6_CHANGE_MARK	PSI6_INDEX	PSI6_COUNT
PSI7	PBCCH	0 – 8	PSI7_CHANGE_MARK	PSI7_INDEX	PSI7_COUNT
PSI8	PBCCH	0 – 8	PSI8_CHANGE_MARK	PSI8_INDEX	PSI8_COUNT
PSI16	PBCCH	0 – 8	PSI16_CHANGE_MARK	PSI16_INDEX	PSI16_COUNT

A consistent set of system information messages is identified by a PSI *change mark* parameter included in each message in the set. All messages within a consistent set shall have the same value of this parameter.

The total number of system information messages of a certain type within a consistent set is indicated by a PSI *count* parameter included in each message in the set. The position of a certain message instance within the consistent set of system information messages is indicated by a PSI *index* parameter.

The PSI *count* parameter shall have the value N–1, where N is the number of instances of the particular message type present in the consistent set. The PSI *index* parameter shall have a range from zero to N–1. Different instances of a particular message type in a consistent set shall have different values of the PSI *index* parameter.

5.4.2.2 Paging

See 3GPP TS 44.060 sub-clause 5.5.2.2.

5.4.2.3 Network Assisted Cell Change

See 3GPP TS 44.060 sub-clause 5.5.2.3.

5.5 Measurement reports

5.5.1 General

See 3GPP TS 44.060 sub-clause 5.6.0.

5.5.2 Network Control (NC) measurement reporting

The behaviour of the mobile station is controlled by the parameter NETWORK_CONTROL_ORDER broadcast in the PSI5 message on PBCCH, in the SI13, SI13-Alt and SI2quater messages on the BCCH and in the PSI13 message on PACCH. Alternatively, the network may send the NETWORK_CONTROL_ORDER parameters in a PACKET MEASUREMENT ORDER or in a PACKET CELL CHANGE ORDER message on PCCCH or PACCH to a particular mobile station. The parameter NETWORK_CONTROL_ORDER may have one of the values NC0, NC1, NC2 or RESET (see 3GPP TS 45.008).

When in mode NC1 or NC2, the mobile station shall perform the NC measurements as defined in 3GPP TS 45.008. The reporting periods are indicated in the NC_REPORTING_PERIOD_I and NC_REPORTING_PERIOD_T field of the PSI5, the SI2quater, the PACKET CELL CHANGE ORDER or the PACKET MEASUREMENT ORDER message. If NC_NON_DRX_PERIOD, NC_REPORTING_PERIOD_I or NC_REPORTING_PERIOD_T have not been received by the mobile station the default values shall be used. The mobile station shall apply to the timer T3158 either the NC_REPORTING_PERIOD_I when in MAC-Idle state or the NC_REPORTING_PERIOD_T when in MAC-Shared state. The measurement results shall be sent to the network using the procedures specified in sub-clause 7.4 for MAC Idle state, and in sub-clause 8.4 for MAC-Shared state.

On expiry of timer T3158, the mobile station shall restart timer T3158 with the indicated reporting period, perform the measurements and send either the PACKET MEASUREMENT REPORT message or the PACKET ENHANCED MEASUREMENT REPORT to the network. The condition for sending the PACKET ENHANCED MEASUREMENT REPORT message instead of the PACKET MEASUREMENT REPORT message is based on the REPORT_TYPE parameter and if the MS has received BSIC information for all cells. For the detailed conditions see 3GPP TS 44.060 sub-clause 11.2.23, sub-clause 11.2.4 and sub-clause 11.2.9b and also 3GPP TS 44.018 sub-clause 10.5.2.33b.

A mobile station in mode NC1 or NC2 may receive a new indicated reporting period while timer T3158 is active. If the new indicated reporting period is less than the time to expiry of timer T3158, the mobile station shall immediately restart timer T3158 with the new indicated reporting period. Otherwise, the timer T3158 shall continue to run.

When changing from MAC-Shared state to MAC-Idle state, a mobile station in mode NC1 or NC2 shall restart the timer T3158 with the reporting period determined by the NC_REPORTING_PERIOD_I parameter if at least one PACKET MEASUREMENT REPORT or PACKET ENHANCED MEASUREMENT REPORT message was sent in MAC-Shared state. Otherwise the timer T3158 shall continue to run.

When changing from MAC-Idle state to MAC-Shared state, a mobile station in mode NC1 or NC2 shall restart the timer T3158 with the reporting period determined by the NC_REPORTING_PERIOD_T parameter if the reporting period is less than the time to expiry of timer T3158. Otherwise the timer T3158 shall continue to run.

When a mobile station in *Iu mode* leaves RRC-Cell Shared state and enters RRC-GRA_PCH state or RRC-Idle mode, the timer T3158 shall be stopped and no more measurement reports shall be sent to the network.

A mobile station may reselect a new cell or may be ordered to reselect a new cell with mode NC1 or NC2 while timer T3158 is active. If time to expiry of timer T3158 is greater than the indicated reporting period for the new cell, the mobile station shall immediately restart timer T3158 with the indicated reporting period for the new cell. Otherwise, the timer T3158 shall continue to run.

At cell reselection the NC measurement parameters valid for the mobile station in the new cell (NETWORK_CONTROL_ORDER, NC_NON_DRX_PERIOD, NC_REPORTING_PERIOD_I and NC_REPORTING_PERIOD_T) are either:

- brought from the old cell (if received in a PACKET MEASUREMENT ORDER or PACKET CELL CHANGE ORDER message); or
- received in a broadcast PSI5, SI13, SI13-Alt, PSI13 or SI2quater message in the new cell. If no parameters have been brought from the old cell, and until individual measurement parameters are received in the new cell, the mobile station shall use the broadcast measurement parameters from PSI5 or use the default parameter values.

The default frequency list to be applied in the new cell shall be the BA(GPRS) list of that cell until a new PACKET MEASUREMENT ORDER message is received. The BA(GPRS) list could also have been modified by frequency parameters received in a PACKET_CELL_CHANGE_ORDER message in the old cell.

For (NC) measurement reporting, the Mobile Station shall use PACKET ENHANCED MEASUREMENT REPORT messages instead of PACKET MEASUREMENT REPORT messages if that is indicated by the parameter REPORT_TYPE and if at least one BSIC is allocated to each frequency in the BA(GPRS) list.

For a multi-RAT mobile station, reports on 3G cells may also be included in the reporting. For report with the PACKET MEASUREMENT REPORT message, reporting is performed on two separate lists: the BA(GPRS) and the 3G Neighbour Cell List (for a multi-RAT MS). For report with the PACKET ENHANCED MEASUREMENT REPORT message, reporting is performed on the Neighbour Cell List (defined in 3GPP TS 44.060 sub-clause 5.6.3.3).

A mobile station that has been allocated one or more DBPSCHs, shall not send Network Control measurement reports to the network during that period. The mobile station shall return to the previous reporting mode when all the DBPSCHs have been released.

5.5.3 Extended measurement (EM) reporting

See 3GPP TS 44.060 sub-clause 5.6.3.

5.5.4 Additional measurement and reporting parameters

See 3GPP TS 44.060 sub-clause 5.6.4.

5.6 Mapping of Signalling Radio Bearers (SRB) onto logical channels

5.6.1 Downlink

In downlink direction, the mapping of SRBs onto logical channels is left up to network implementation. The rules defined in sub-clause 5.6.2 should be used. The MS shall be able to receive SRB data on any of the following logical channels if available: SDCCH, SACCH, FACCH, PDTCH and SFACCH.

5.6.2 Uplink

5.6.2.1 MAC-Dedicated State

Table 5.6.2.1.1 represents the alternatives for mapping a given SRB onto a given logical channel when the MS is in MAC-Dedicated state. The MS shall obey the rules given in this table. Only the logical channels available for SRBs are listed.

Table 5.6.2.1.1: Mapping of SRBs onto logical channels in MAC-Dedicated State

	MAC-Dedicated State		
	SDCCH + SACCH	FACCH + SACCH	PDTCH + SACCH
SRB1	SACCH	SACCH	SACCH
SRB2	SDCCH	FACCH	PDTCH
SRB3	SDCCH	FACCH	PDTCH
SRB4	SDCCH	SACCH	PDTCH

5.6.2.2 MAC-Shared State

Table 5.6.2.2.1 represents the alternatives for mapping a given SRB onto a given logical channel when the MS is in MAC-Shared state. The MS shall obey the rules given in this table. Only the logical channels available for SRBs are listed.

Table 5.6.2.2.1: Mapping of SRBs onto logical channels in MAC-Shared State

	MAC-Shared State	
	PDTCH + SFACCH	
SRB1	PDTCH xor SFACCH (<i>i</i>)	
SRB2	PDTCH xor SFACCH (<i>i</i>)	
SRB3	PDTCH xor SFACCH (<i>i</i>)	
SRB4	PDTCH xor SFACCH (<i>i</i>)	
Rule <i>i</i> :	PDTCH shall be used if and only if the corresponding TBF is established or a TBF establishment request is ongoing for this SRB, otherwise SFACCH shall be used.	

5.6.2.3 MAC-DTM State

Table 5.6.2.3.1 represents the alternatives for mapping a given SRB onto a given logical channel when the MS is in MAC-DTM state. The MS shall obey the rules given in this table. Only the logical channels available for SRBs are listed.

Table 5.6.2.3.1: Mapping of SRBs onto logical channels in MAC-DTM State

MAC-DTM State (FACCH/H + SACCH/H) + (PDTCH/H (see note) + SFACCH/H)	
SRB1	SACCH/H
SRB2	PDTCH/H xor FACCH/H (ii)
SRB3	PDTCH/H xor SFACCH/H (i)
SRB4	PDTCH/H xor SFACCH/H (i)

MAC-DTM State (FACCH/F + SACCH/F) + (PDTCH/F + SFACCH/F)	
SRB1	SACCH/F
SRB2	FACCH/F xor PDTCH/F (ii)
SRB3	PDTCH/F xor SFACCH/F (i)
SRB4	PDTCH/F xor SFACCH/F (i)

MAC-DTM State (PDTCH + SACCH) + (PDTCH + SFACCH)	
SRB1	SACCH
SRB2	PDTCH (iii)
SRB3	PDTCH xor SFACCH (i)
SRB4	PDTCH xor SFACCH (i)
Rule i:	PDTCH shall be used if and only if the corresponding TBF is established or a TBF establishment request is ongoing for this SRB, otherwise SFACCH shall be used.
Rule ii:	PDTCH shall be used if and only if the corresponding TBF is established or a TBF establishment request is ongoing for SRB2, else FACCH shall be used.
Rule iii:	PDTCH on SBPSCH shall be used if and only if the corresponding TBF is established or a TBF establishment request is ongoing for SRB2, else PDTCH on DBPSCH shall be used.
NOTE:	Single-slot operation with exclusive allocation.

6 Paging procedures

6.1 General

The Packet Paging procedure is always initiated upon request by RRC. RRC shall provide all the necessary information to construct a PACKET PAGING REQUEST message. The MAC layer shall include in the PACKET PAGING REQUEST message all information received from the RRC layer. A number of mobile stations can be paged in the same paging message.

On receipt of a PACKET PAGING REQUEST message, the MAC shall forward all received information for this mobile station to RRC.

6.2 Paging initiation in MAC-Idle state

In MAC-Idle state and upon request from RRC, the MAC layer initiates the Packet Paging procedure by transmitting a PACKET PAGING REQUEST message on an appropriate paging subchannel on the PCCCH, taking into account the DRX parameters valid for each targeted mobile station (see sub-clause 5.4.1.8).

The following IEs shall be included in the in the PACKET PAGING REQUEST message. RRC determines the values of the IEs (see 3GPP TS 44.118).

- MS Identity (IMSI, TMSI, P-TMSI or G-RNTI).

The following IEs may be included in the in the PACKET PAGING REQUEST message. RRC determines which IEs to include and their values (see 3GPP TS 44.118).

- CN domain identity.
- Paging cause.
- Paging Record Type Identifier.

6.3 Paging initiation in MAC-Shared state

In MAC-Shared state and upon request from RRC, the MAC layer initiates the paging procedure by transmitting a PACKET PAGING REQUEST message on the PACCH.

The following IEs shall be included in the in the PACKET PAGING REQUEST message. RRC determines the values of the IEs (see 3GPP TS 44.118).

- MS Identity (IMSI, TMSI, P-TMSI or G-RNTI).

The following IEs may be included in the in the PACKET PAGING REQUEST message. RRC determines which IEs to include and their values (see 3GPP TS 44.118).

- CN domain identity.
- Paging cause.
- Paging Record Type Identifier.

6.4 Reception of PACKET PAGING REQUEST by an MS

Upon reception of a PACKET PAGING REQUEST message on either PCCCH or PACCH, the MAC shall forward all received information for this mobile station to RRC.

7 Medium Access Control (MAC) procedures on PCCCH

7.1 General

The establishment of a Temporary Block Flow (TBF) can be initiated by either the mobile station or the network.

The request for establishment of a TBF using the PCCCH is described in this sub-clause. For mobile stations in MAC-Idle state measurement reports messages are sent on temporary fixed allocations without the establishment of an uplink TBF (see sub-clause 7.4).

7.2 TBF establishment initiated by the mobile station on PCCCH

7.2.1 General

The purpose of the packet access procedure is to establish a TBF to support the transfer of upper-layer PDUs in the direction from the mobile station to the network. Packet access shall be done on PCCCH, as defined in this sub-clause. The packet access can be done in either one phase (sub-clause 7.2.3) or in two phases (sub-clauses 7.2.3 and 7.2.4).

TBF establishment can also be done on PACCH if a TBF for transfer of upper-layer PDUs in the direction from the network to the mobile station is already established (see sub-clause 8.2.2.1.3). TBF establishment can also be done on PACCH if the mobile station is releasing its last TBF for transfer of upper-layer PDUs in the direction from the mobile station to the network and TBF for transfer of upper-layer PDUs in the direction from the network to the mobile station is not established (see sub-clause 10.4.5.5 and sub-clause 10.4.6.4).

If the mobile station is in MAC-Dedicated state the establishment of a TBF shall be performed by the procedures specified in 3GPP TS 44.118.

The packet access procedure is initiated by the mobile station. Initiation is triggered by a request from upper layers to transfer an upper-layer PDU using the primitives that are defined in sub-clause 4.3.

Upon such a request:

- if access to the network is allowed (sub-clause 7.2.2), the mobile station shall initiate the packet access procedure as defined in sub-clause 7.2.3.1.1;
- otherwise, the MAC sublayer in the mobile station shall reject the request.

7.2.2 Permission to access the network

See 3GPP TS 44.060 sub-clause 7.1.1.

7.2.3 Initiation of a TBF establishment

7.2.3.1 Initiation of the packet access procedure

7.2.3.1.1 General

The mobile station shall initiate the packet access procedure by scheduling the sending of (EGPRS) PACKET CHANNEL REQUEST messages on the PRACH corresponding to its PCCCH_GROUP. The mobile station shall use the last access parameters received on PBCCH. At sending of the first (EGPRS) PACKET CHANNEL REQUEST message, the mobile station shall store the value for the Retry (R) bit to be transmitted in all the subsequent MAC headers for this TBF as 'MS sent channel request message once'. If a second (EGPRS) PACKET CHANNEL REQUEST message is sent, the mobile station shall change the value for the Retry (R) bit to 'MS sent channel request message once or more'.

While waiting for a response to the (EGPRS) PACKET CHANNEL REQUEST message, the mobile station shall monitor the full PCCCH corresponding to its PCCCH_GROUP. The mobile station shall perform signal strength measurements as they are defined for MAC-Idle state (see 3GPP TS 45.008).

While monitoring the full PCCCH, the mobile station shall decode any occurrence of the PERSISTENCE_LEVEL parameter included in a message received on PCCCH. When the mobile station receives the PERSISTENCE_LEVEL parameter, the value of the PERSISTENCE_LEVEL parameter shall be taken into account at the next (EGPRS) PACKET CHANNEL REQUEST attempt that follows.

The (EGPRS) PACKET CHANNEL REQUEST messages are sent on PRACH and contain an indication of the type of access and parameters required to indicate the mobile station's demand of radio resource.

There are two formats of the PACKET CHANNEL REQUEST message containing either 8 bits or 11 bits of information. The format to be applied on PRACH is controlled by the parameter ACC_BURST_TYPE which is broadcast on PBCCH. The cause value to be used in the PACKET CHANNEL REQUEST message for a non-EGPRS TBF mode capable MS depends on the purpose of the packet access procedure as follows:

- If the mobile station intends to use the TBF to send user data it shall determine the RLC mode from the configuration of the radio bearer for which the TBF is to be established. If the requested RLC mode is acknowledged mode and the amount of data can fit in 8 or less than 8 RLC/MAC blocks, the mobile station shall indicate Short Access as access type. The number of blocks shall be calculated assuming channel coding scheme CS-1 for standard GPRS TBFs, and MCS-1 for EGPRS TBFs. If the requested RLC mode is acknowledged mode and the amount of data to send takes more than 8 RLC/MAC blocks, the mobile station shall request either one phase access or two phase access. If the requested RLC mode is unacknowledged mode, the mobile station shall indicate in the PACKET CHANNEL REQUEST message either One phase Access Request in RLC unacknowledged mode or two phase access.
- If the purpose of the packet access procedure is to send a message on SRB1; in this case, the mobile station shall indicate either 'Single Block Without TBF Establishment' or 'One phase Access Request in RLC unacknowledged mode' in the PACKET CHANNEL REQUEST message.

- If the purpose of the packet access procedure is to send a message on SRB2-4 and a dedicated channel is not needed; in this case the mobile station shall indicate 'MM Procedure' in the PACKET CHANNEL REQUEST message.
- If the purpose of the packet access procedure is to send a message on SRB2-4 and a dedicated channel is needed; in this case, the mobile station shall indicate 'Dedicated channel request' in the PACKET CHANNEL REQUEST message
- If the purpose of the packet access procedure is to initiate an Emergency Call; in this case, the mobile station shall indicate 'Emergency Call' in the PACKET CHANNEL REQUEST message.
- If the purpose of the packet access procedure is to request multiple TBFs, the mobile station shall request a two phase access.

EGPRS TBF mode capable MSs shall monitor the GPRS Cell Options IE on the PBCCH(PSI1/PSI13) for the cell's EGPRS capability. In the GPRS Cell Options IE it is also indicated if the EGPRS PACKET CHANNEL REQUEST is supported in the cell.

- If the cell is EGPRS TBF mode capable and EGPRS PACKET CHANNEL REQUEST is supported in the cell the EGPRS PACKET CHANNEL REQUEST messages shall be used at one-phase access attempts (in RLC acknowledged or unacknowledged mode), two-phase access attempts, short access attempts, sending of a message on SRB2-4 if a dedicated channel is needed or initiation of an emergency call. The corresponding cause value shall be used.
- If the cell is EGPRS TBF mode capable and EGPRS PACKET CHANNEL REQUEST messages are not supported in the cell or if the cell is not EGPRS TBF mode capable, the EGPRS TBF mode capable mobile station shall use the PACKET CHANNEL REQUEST message as for non-EGPRS TBF mode capable MSs (see above).

7.2.3.1.2 Access persistence control on PRACH

See 3GPP TS 44.060 sub-clause 7.1.2.1.1.

7.2.3.2 Packet assignment procedure

7.2.3.2.1 On receipt of a PACKET CHANNEL REQUEST or EGPRS PACKET CHANNEL REQUEST message

7.2.3.2.1.1 General

On receipt of a PACKET CHANNEL REQUEST or EGPRS PACKET CHANNEL REQUEST message, the network may assign to the mobile station a radio resource on either one or more SBPSCHs or on one or more DBPSCHs, based on the cause field in the received message. The network shall not assign more than one DBPSCH/S to the mobile station.

7.2.3.2.1.2 Allocation of resource on SBPSCH(s)

See 3GPP TS 44.060 sub-clause 7.1.2.2.1

7.2.3.2.1.3 Allocation of resource on DBPSCH(s)

When the mobile station has been allocated a resource on one or more DBPSCHs, the allocated dedicated resource is assigned to the mobile station in a PACKET DBPSCH ASSIGNMENT message, sent on any PAGCH block on the same PCCCH on which the network has received the PACKET CHANNEL REQUEST or EGPRS PACKET CHANNEL REQUEST message. The *Packet Request Reference* information element shall be used to address the mobile station and frequency parameters shall be included.

The mobile station may use information received on PBCCH or a previous assignment message to decode the frequency parameters contained in the assignment message. If the mobile station detects an invalid *Frequency Parameters* information element in the assignment message, it shall abort the procedure, if required initiate a partial acquisition of PBCCH information, and may then re-initiate this procedure.

In case the allocated channel type is PDTCH+PACCH+SACCH (see 3GPP TS 44.060), the network shall include the USF value to be used on PDTCH and PACCH in the PACKET DBPSCH ASSIGNMENT message.

On receipt of a PACKET DBPSCH ASSIGNMENT message corresponding to one of its 3 last PACKET CHANNEL REQUEST or EGPRS PACKET CHANNEL REQUEST messages the mobile station shall stop timers T3186 and T3170 if running and stop sending PACKET CHANNEL REQUEST or EGPRS PACKET CHANNEL REQUEST messages. The mobile station shall then switch to the assigned DBPSCH(s), enter the MAC-Dedicated state and proceed with contention resolution of the one phase packet access procedure according to sub-clause 7.2.3.3.2.

When the mobile station switches to the assigned DBPSCH(s), it shall take into account the power control parameters received in downlink SACCH blocks, perform signal strength measurements and apply output power control procedures as they are defined for MAC-Dedicated state (see 3GPP TS 45.008). The mobile station shall not send any measurement reports until contention resolution is complete. It shall follow the procedures in sub-clauses 9 and 11.

7.2.3.2.1.4 Packet access queuing notification procedure

See 3GPP TS 44.060 sub-clause 7.1.2.2.2.

7.2.3.2.1.5 Packet polling procedure

See 3GPP TS 44.060 sub-clause 7.1.2.2.3.

7.2.3.2.1.6 Packet access reject procedure

The network may, as response to a PACKET CHANNEL REQUEST or EGPRS PACKET CHANNEL REQUEST message, send to the mobile station a PACKET ACCESS REJECT message on any PAGCH block on the same PCCCH on which the channel-request message was received. This message contains the request reference with time of reception of the PACKET CHANNEL REQUEST or EGPRS PACKET CHANNEL REQUEST message and optionally a WAIT_INDICATION field in the *Reject structure* of the PACKET ACCESS REJECT message.

On receipt of a PACKET ACCESS REJECT message containing a *Reject structure* addressed to the mobile station, where the *Packet Request Reference* in the *Reject structure* corresponds to one of the mobile station's last 3 PACKET CHANNEL REQUEST or EGPRS PACKET CHANNEL REQUEST messages:

- The mobile station shall stop T3186, stop sending PACKET CHANNEL REQUEST or EGPRS PACKET CHANNEL REQUEST messages, start T3172 with the value indicated in the WAIT_INDICATION field, start T3170 if it has not already been started, and listen to the downlink PCCCH until T3170 expires. During this time, the mobile station shall ignore additional PACKET ACCESS REJECT messages, but on reception of any PACKET UPLINK ASSIGNMENT or PACKET DBPSCH ASSIGNMENT message corresponding to any other of its last 3 PACKET CHANNEL REQUEST or EGPRS PACKET CHANNEL REQUEST messages, the mobile station shall stop T3170, stop T3172, and follow the procedure defined in sub-clause 7.2.3.2.1.
- If no PACKET UPLINK ASSIGNMENT or PACKET DBPSCH ASSIGNMENT message is received before expiration of T3170, the mobile station shall indicate a packet access failure to upper layer and return to *MAC-Idle state*. As an option, the mobile station may stop T3170, indicate a packet access failure to upper layer and return to *MAC-Idle state* as soon as it has received responses from the network on all, or in case more than 3 were sent, the last 3 of its PACKET CHANNEL REQUEST or EGPRS PACKET CHANNEL REQUEST messages.
- If an erroneous PACKET UPLINK ASSIGNMENT or PACKET DBPSCH ASSIGNMENT message (*e.g.*, the mobile station has been assigned more PDCHs than it supports according to its multislot class) addressed to the mobile station is received before expiration of T3170, the mobile station shall stop T3170 and act as stated in sub-clause 7.2.5.
- If the mobile station receives a PACKET DOWNLINK ASSIGNMENT message, it shall stop T3170 and respond to the message (see sub-clause 7.3.2).

- If the mobile station receives a PACKET DBPSCH ASSIGNMENT message, it shall stop T3170 and respond to the message (see sub-clause 7.3.3).
- The mobile station shall not make a new attempt for packet access in the same cell until T3172 expires, but may attempt packet access in another cell after successful cell reselection for radio-conditions reasons (see 3GPP TS 45.008).
- The value of the WAIT_INDICATION field (*i.e.*, T3172) relates to the cell from which it was received.

7.2.3.3 Contention resolution at one phase access

7.2.3.3.1 Contention resolution at one phase access on SBPSCHs

The G-RNTI is used to uniquely identify the mobile station when sending on uplink. The Radio bearer Id is used to identify the RLC instance to which the RLC/MAC block belongs. Every RLC data block that is sent on the TBF shall include the G-RNTI of the mobile station and the RB Id of the RLC instance being addressed, until the contention resolution is completed on the mobile station side. If MCS-7, MCS-8 or MCS-9 is used for the transmission of the G-RNTI and RB Id in EGPRS TBF mode (*i.e.* the RLC/MAC block is carrying two RLC data blocks), the G-RNTI and RB Id shall be inserted in both RLC data blocks. The G-RNTI and RB Id shall also be included in the PACKET RESOURCE REQUEST message, if sent during the contention resolution. If ciphering is used, the least significant bit of the uplink HFN of this radio bearer shall be inserted in each RLC data block sent on the TBF and if applicable in the PACKET RESOURCE REQUEST message until the contention resolution is completed on the mobile station side. If the least significant bit of the HFN in the network for the same radio bearer in the same direction is different from the one received from the mobile station, the network shall increase its HFN by one unit.

The retransmission of an RLC data block shall include the G-RNTI and RB Id if the RLC data block was originally transmitted including these fields, also if the retransmission occurs after the completion of the contention resolution.

At sending of the first RLC data block, the mobile station shall stop timer T3164, set counter N3104 to 1, and start timer T3166. The counter N3104 shall be stepped each time the mobile station sends an RLC data block.

The network shall respond by including the G-RNTI in the PACKET UPLINK ACK/NACK message after the first correctly received RLC data block that comprises the G-RNTI and RB Id. In EGPRS TBF mode, the network may instead respond by addressing the mobile station with the TFI of the assigned TBF and including the G-RNTI (in the CONTENTION_RESOLUTION_TLLI field) in a PACKET UPLINK ASSIGNMENT message, if the resources allocated for the TBF need to be reallocated (see sub-clause 8.2.2.1.2).

The contention resolution is completed on the network side when the network receives an RLC data block that comprises the G-RNTI value that identifies the mobile station, the RB Id that identifies the RLC instance being addressed and the TFI value associated with the TBF.

The contention resolution is successfully completed on the mobile station side when the mobile station receives a PACKET UPLINK ACK/NACK message addressing the mobile station with the TFI value associated with the uplink TBF and including the same G-RNTI value that the mobile station has included in the RLC header of the first RLC data blocks, or alternatively, in EGPRS TBF mode, a PACKET UPLINK ASSIGNMENT message addressing the mobile station with the TFI value associated with the uplink TBF and including the same G-RNTI value that the mobile station included in the RLC header of the first RLC data blocks. The mobile shall then stop timer T3166 and counter N3104.

The contention resolution has failed on the mobile station side when the counter N3104 reaches its maximum value, or timer T3166 expires. The contention resolution also fails, if the mobile station receives a PACKET UPLINK ACK/NACK message or in EGPRS TBF mode alternatively a PACKET UPLINK ASSIGNMENT message addressing the mobile station with the TFI associated with the uplink TBF and including a G-RNTI value other than that the mobile station included in the RLC header of the first RLC data blocks; in such a case, the mobile station shall not transmit a PACKET CONTROL ACKNOWLEDGEMENT in the uplink radio block specified if a valid RRBp field is received as part of the PACKET UPLINK ACK/NACK message or in EGPRS TBF mode alternatively as part of the PACKET UPLINK ASSIGNMENT message.

In case of a contention resolution failure on the mobile station side, the mobile station shall reset the counter N3104 and stop timer T3166. The mobile station shall stop transmitting on the TBF and reinitiate the packet access procedure, unless the packet access procedure has already been attempted four times. In that case, a TBF failure has occurred, see sub-clause 7.2.5.

7.2.3.3.2 Contention resolution at one phase access on DBPSCH

7.2.3.3.2.1 General

During contention resolution the mobile station shall only send on the RB for which packet access was initiated via the PCCCH. The RB may be mapped onto a PDTCH, SDCCH or FACCH logical channel.

7.2.3.3.2.2 Contention resolution at one phase access on PDTCH

The G-RNTI is used to identify uniquely the mobile station when sending on uplink. The Radio bearer Id is used to identify the RLC instance to which the RLC/MAC block belongs. Every RLC data block that is sent on any of the mobile station's TBFs, shall include the G-RNTI of the mobile station, until the contention resolution is completed on the mobile station side.

The retransmission of an RLC data block shall include the G-RNTI if the RLC data block was originally transmitted including this field, also if the retransmission occurs after the completion of the contention resolution.

At sending of the first RLC data block, the mobile station shall set counter N3104 to 1, and start timer T3166. The counter N3104 shall be incremented each time the mobile station sends a RLC data block.

The network shall respond by including the G-RNTI in the PACKET UPLINK ACK/NACK message after the first correctly received RLC data block that comprises the G-RNTI and valid RB Id.

The contention resolution is completed on the network side when the network receives an RLC data block that comprises the G-RNTI value that identifies the mobile station, and a valid RB Id that identifies the RLC instance to which the RLC/MAC block belongs.

The contention resolution is successfully completed on the mobile station side when the mobile station receives a PACKET UPLINK ACK/NACK message addressing the mobile station with a valid RBId (contained in the UPLINK_TFI field, see 3GPP TS 44.060) and including the same G-RNTI value that the mobile station included in the RLC header of the first RLC data blocks. The mobile station shall then stop timer T3166 and counter N3104.

The contention resolution has failed on the mobile station side when the counter N3104 reaches its maximum value, or timer T3166 expires. The contention resolution also fails, if the mobile station receives a PACKET UPLINK ACK/NACK message addressing the mobile station with a G-RNTI value other than that the mobile station included in the RLC header of the first RLC data blocks; in such a case, the mobile station shall not transmit a PACKET CONTROL ACKNOWLEDGEMENT in the uplink radio block specified if a valid RRBp field is received as part of the PACKET UPLINK ACK/NACK message.

In case of a contention resolution failure on the mobile station side, the mobile station shall reset the counter N3104 and stop timer T3166. The mobile station shall stop transmitting on the TBF and reinitiate the packet access procedure, unless the packet access procedure has already been attempted four times. In that case, a TBF failure has occurred, see sub-clause 7.2.5.

7.2.3.3.2.3 Contention resolution at one phase access on SDCCH or FACCH

The G-RNTI is used to identify uniquely the mobile station when sending on uplink. The Reduced Radio bearer Id is used to identify the RLC instance to which the RLC/MAC block belongs. Every RLC data block that is sent on any of the mobile station's TBFs, shall include the G-RNTI of the mobile station, until the contention resolution is completed on the mobile station side.

The retransmission of an RLC data block shall include the G-RNTI if the RLC data block was originally transmitted including this field, also if the retransmission occurs after the completion of the contention resolution.

At sending of the first RLC data block, the mobile station shall set counter N3104 to 1, and start timer T3166. The counter N3104 shall be incremented each time the mobile station sends a RLC data block.

The network shall respond by including the G-RNTI in the PACKET DBPSCH UPLINK ACK/NACK message after the first correctly received RLC data block that comprises the G-RNTI and valid RRB Id.

The contention resolution is completed on the network side when the network receives an RLC data block that comprises the G-RNTI value that identifies the mobile station, and a valid RRB Id that identifies the RLC instance to which the RLC/MAC block belongs.

The contention resolution is successfully completed on the mobile station side when the mobile station receives a PACKET DBPSCH UPLINK ACK/NACK message addressing the mobile station with a valid RBId (i.e. associated with an assigned RRB Id) and including the same G-RNTI value that the mobile station included in the RLC header of the first RLC data blocks. The mobile station shall then stop timer T3166 and counter N3104.

The contention resolution has failed on the mobile station side when the counter N3104 reaches its maximum value, or timer T3166 expires. The contention resolution also fails, if the mobile station receives a PACKET DBPSCH UPLINK ACK/NACK message addressing the mobile station with a G-RNTI value other than that the mobile station included in the RLC header of the first RLC data blocks; in such a case, the mobile station shall not transmit a PACKET CONTROL ACKNOWLEDGEMENT even if the poll bit is set in the received message.

In case of a contention resolution failure on the mobile station side, the mobile station shall reset the counter N3104 and stop timer T3166. The mobile station shall stop transmitting on the TBF and reinitiate the packet access procedure, unless the packet access procedure has already been attempted four times. In that case, a TBF failure has occurred, see sub-clause 7.2.5.

7.2.3.4 RLC/MAC procedures during contention resolution

7.2.3.4.1 RLC/MAC procedures during contention resolution on SBPSCHs

During the contention resolution, the mobile station may receive a non-distribution RLC/MAC control message addressing the mobile station by G-RNTI or the TFI value associated with the uplink TBF. The mobile station shall act on that message using the procedure defined for the message when it is received in MAC-Shared state during operation on an uplink TBF (see sub-clause 8), with the following restrictions:

- The mobile station shall not accept a PACKET MEASUREMENT ORDER message, a PACKET CELL CHANGE ORDER message and a PACKET POWER CONTROL/TIMING ADVANCE message addressing the mobile station with the TFI value associated with the uplink TBF.
- The mobile station shall not accept a PACKET DOWNLINK ASSIGNMENT, a MULTIPLE TBF DOWNLINK ASSIGNMENT, a PACKET TIMESLOT RECONFIGURE or a MULTIPLE TBF TIMESLOT RECONFIGURE message.

If a valid RRBp field is received as part of the RLC/MAC control block and the mobile station acts on the message, then it shall transmit a PACKET CONTROL ACKNOWLEDGEMENT message in the uplink radio block specified (see 3GPP TS 44.060 sub-clause 10.4.5); The mobile station shall not transmit a PACKET CONTROL ACKNOWLEDGEMENT message if it does not act on the received message.

In either case, the mobile station shall continue with the contention resolution on the uplink TBF, till it either completes successfully or fails, or that the uplink TBF is released as a result of the procedure defined for the message that is received.

During the contention resolution at one phase access, the mobile station shall not send a Packet Resource Request message to request the establishment of additional UL TBFs.

7.2.3.4.2 RLC/MAC procedures during contention resolution on DBPSCHs

During the contention resolution, the mobile station may receive a non-distribution RLC/MAC control message addressing the mobile station by G-RNTI, RB Id (PACCH) or the RRB Id (SDCCH or FACCH) value associated with one its uplink TBFs. The mobile station shall act on that message using the procedure defined for the message in sub-clause 9.

If a RLC/MAC control block is received with the poll bitset or with valid RRBp field and the mobile station acts on the message, then it shall transmit a PACKET CONTROL ACKNOWLEDGEMENT message in the next possible uplink occurrence on the same logical channel. The mobile station shall continue with the contention resolution on the uplink TBF, until it either completes successfully or fails, or that the uplink TBF is released through release of the dedicated resource using the CRLC-CONFIG primitive (see sub-clause 4.3.3.1)

7.2.3.5 One phase packet access completion

7.2.3.5.1 One phase packet access completion on SBPSCHs

See 3GPP TS 44.060 sub-clause 7.1.2.4.

7.2.3.5.2 One phase packet access completion on DBPSCHs

The one phase packet access procedure is completed upon a successful contention resolution.

7.2.3.6 Timing Advance

7.2.3.6.1 Timing advance on SBPSCHs

See 3GPP TS 44.060 sub-clause 7.1.2.5.

7.2.3.6.2 Timing advance on DBPSCHs

Initial timing advance may be provided in the PACKET DBPSCH ASSIGNMENT message in the TIMING_ADVANCE_VALUE field.

7.2.4 TBF establishment using two phase access

7.2.4.1 Initiation of the Packet resource request procedure

In the first phase of a two-phase access, the same procedures as for one-phase access shall be used until the network sends to the mobile station a PACKET UPLINK ASSIGNMENT message including a *Single Block Allocation struct* or a *Multi Block Allocation struct*. The network may only include a *Multi Block Allocation struct* if it sends the PACKET UPLINK ASSIGNMENT message in response to an EGPRS PACKET CHANNEL REQUEST.

A two-phase access may be initiated:

- by the network, by ordering the mobile station to send a PACKET RESOURCE REQUEST message. The order shall be sent implicitly to the mobile station in the PACKET UPLINK ASSIGNMENT message by including a *Single Block Allocation struct* or a *Multi Block Allocation struct*;
- by a mobile station, by requiring a two-phase access in the PACKET CHANNEL REQUEST or EGPRS PACKET CHANNEL REQUEST message. If access is granted, the network shall order the mobile station to send a PACKET RESOURCE REQUEST message. The order shall be sent implicitly to the mobile station in the PACKET UPLINK ASSIGNMENT message by including a *Single Block Allocation struct* or a *Multi Block Allocation struct*.

When the mobile station has received the PACKET UPLINK ASSIGNMENT message, it shall respond with a PACKET RESOURCE REQUEST message in the first allocated radio block. If the network allocated more than a single radio block, the mobile station shall send any of the following in each additional block:

- Another control block (*e.g.*, a PACKET UPLINK DUMMY CONTROL BLOCK or a PACKET MEASUREMENT REPORT message); however, the mobile station shall not send an ADDITIONAL MS RADIO ACCESS CAPABILITIES message or a PACKET RESOURCE REQUEST message.
- Nothing.

The mobile station may request the establishment of multiple UL TBFs in the PACKET RESOURCE REQUEST message. The *MS Radio Access Capability* IE shall not be included in the PACKET RESOURCE REQUEST message. If ciphering is used, the least significant bit of the uplink HFN of the radio bearer for which radio resources are requested, shall be inserted in the PACKET RESOURCE REQUEST message. If the least significant bit of the HFN in the network for the same radio bearer in the same direction is different from the one received from the mobile station, the network shall increase its HFN by one unit.

When the mobile station switches to the assigned PDCH, it shall take the power control parameters received in the PACKET UPLINK ASSIGNMENT message into account, perform signal strength measurements and apply output power control procedures as they are defined for MAC-Shared state (see 3GPP TS 45.008).

At sending of the PACKET RESOURCE REQUEST message, the mobile station shall start timer T3168 for each of the radio bearers for which resources were requested. Furthermore, the mobile station shall not respond to PACKET DOWNLINK ASSIGNMENT or MULTIPLE TBF DOWNLINK ASSIGNMENT messages - but may acknowledge such messages if they contain a valid RRBP field - while timer T3168 is running, before contention resolution is completed on the mobile station side.

The mobile station may request an open-ended or a close-ended TBF. If a close-ended TBF is requested, the number of octets of user data that the MS has to transfer in the TBF shall be indicated in the PACKET RESOURCE REQUEST message.

7.2.4.2 Packet resource assignment for uplink procedure

7.2.4.2.1 (void)

7.2.4.2.2 On receipt of a PACKET RESOURCE REQUEST message

On receipt of a PACKET RESOURCE REQUEST message, the network shall respond by sending a PACKET UPLINK ASSIGNMENT or MULTIPLE TBF UPLINK ASSIGNMENT message (radio resources assignment on one or more PDCHs to be used by the mobile station for the TBF in EGPRS or GPRS TBF mode) or a PACKET ACCESS REJECT message to the mobile station on PACCH on the same PDCH on which the mobile station has sent the PACKET RESOURCE REQUEST message. These messages may only be for a subset of the resources requested in the PACKET RESOURCE REQUEST message. For the resource requests that have not been processed by the first assignment or reject message, additional PACKET UPLINK ASSIGNMENT, MULTIPLE TBF UPLINK ASSIGNMENT or PACKET ACCESS REJECT messages may be sent to the mobile station on the PACCH to which the mobile station has been assigned.

On receipt of a PACKET UPLINK ASSIGNMENT or MULTIPLE TBF UPLINK ASSIGNMENT message the mobile station shall switch to the assigned PDCHs. If dynamic or extended dynamic allocation is assigned then start timer T3164 for each of the TBFs that have been assigned resources.

At sending of the first RLC data block on a TBF, the mobile station shall stop timer T3164 for that TBF.

The mobile station may use information received on PBCCH or a previous assignment message to decode the frequency parameters contained in the assignment message. If the mobile station detects an invalid Frequency Parameters information element in the assignment message, it shall abort the procedure, if required initiate a *partial acquisition* of PBCCH information, and may then re-initiate the access on the PRACH.

On receipt of a PACKET ACCESS REJECT message that contains a Reject structure addressed to the mobile station, the mobile station shall stop timer T3168 and indicate a packet access failure to upper layer for those TBFs identified as rejected in the message.

If the PACKET ACCESS REJECT message contains a WAIT_INDICATION field in a Reject structure addressed to the mobile station, the mobile station shall start timer T3172 with the indicated value (Wait Indication). The mobile station is not allowed to make a new attempt for packet access in the same cell until all instances of timer T3172 expires, but may attempt packet access in another cell after successful cell reselection.

7.2.4.3 Contention resolution at two phase access

The contention resolution is completed on the network side when the network receives a G-RNTI value identifying the mobile station, as part of the contention resolution procedure on the TBF.

The contention resolution is completed on the mobile station side when the mobile station receives a PACKET UPLINK ASSIGNMENT message or MULTIPLE TBF UPLINK ASSIGNMENT message with the same G-RNTI as the mobile station has included in the PACKET RESOURCE REQUEST message and assigning resource to at least one radio bearer that requested resource in the PACKET RESOURCE REQUEST message. The mobile station shall then stop timer T3168 for each radio bearer for which resource is granted. It does not include its G-RNTI in any RLC data block.

The contention resolution has failed on the mobile station side when the mobile station does not receive a PACKET UPLINK ASSIGNMENT message or MULTIPLE TBF UPLINK ASSIGNMENT message with its G-RNTI, assigning resource to at least one radio bearer that requested resource in the PACKET RESOURCE REQUEST message, before expiry of timer T3168. The mobile station shall then reinitiate the packet access procedure unless the packet access procedure has already been attempted four times. In that case, TBF failure has occurred for all of the requested TBF(s) and an RLC/MAC error should be reported to the higher layer for each of the radio bearers that requested resources.

On expiry of an instance of timer T3168 after contention resolution is completed on the mobile station side, TBF establishment for the corresponding radio bearer has failed. In that case the mobile station shall reinitiate resource request for that radio bearer using the procedures described in sub-clause 8.2.2.1.2

7.2.4.4 Two phase packet access completion

See 3GPP TS 44.060 sub-clause 7.1.3.4.

7.2.4.5 Timing Advance

See 3GPP TS 44.060 sub-clause 7.1.3.5.

7.2.5 Abnormal cases

If a failure occurs on the mobile station side of the new TBF before the mobile station has successfully completed contention resolution, the newly reserved resources are released; the subsequent behaviour of the mobile station depends on the type of failure and previous actions.

- If the failure is due to a G-RNTI mismatch, or to the expiry of timers T3166 or T3168, or to the fact that the counter N3104 reaches its maximum value in the contention resolution procedure, and repetition as described in sub-clauses 7.2.3.3, 3GPP TS 44.060 sub-clause 7.1.3.2.1 or sub-clause 7.1.3.3 has been performed, the mobile station shall return to MAC-Idle state, notify higher layer (TBF establishment failure), transactions in progress shall be aborted and cell reselection may take place, unless the failure takes place during a Packet Cell Change Order procedure, in which case the mobile behaviour shall be as described in the Abnormal cases of the Network controlled cell reselection procedure in 3GPP TS 44.060 sub-clause 8.4.2.
- If the mobile station has been assigned more PDCHs than it supports according to its MS multislot class, the mobile station shall reinitiate the packet access procedure unless the packet access procedure has already been attempted four times. In that case, TBF failure has occurred.
- If the information in the PACKET UPLINK ASSIGNMENT message does not properly specify an uplink PDCH or violates the mobile station's multislot capabilities, the mobile station shall reinitiate the packet access procedure unless the packet access procedure has already been attempted four times. In that case, TBF failure has occurred.
- If the mobile station has been assigned more than one DBPSCH/S, the mobile station shall reinitiate the packet access procedure unless the packet access procedure has been attempted four times. In that case, TBF failure has occurred.
- If the information in the PACKET DBPSCH ASSIGNMENT message does not properly specify a DBPSCH or violates the mobile station's multislot capabilities, the mobile station shall reinitiate the packet access procedure (i.e. using access cause "dedicated channel request") unless the packet access procedure has already been attempted four times. In that case, TBF failure has occurred.
- If the mobile station has been assigned a TCH that it does not support (e.g. using 8-PSK), the mobile station shall return to MAC-Idle state and notify higher layers (TBF establishment failure).
- If the information in the MULTIPLE TBF UPLINK ASSIGNMENT message does not properly specify an uplink PDCH or violates the mobile station's multislot capabilities, the mobile station shall reinitiate the packet access procedure for each of the TBFs for which there is an error unless the procedure has already been attempted 4 times for the TBF. In that case, TBF failure has occurred.
- If the MULTIPLE TBF UPLINK ASSIGNMENT message contains assignments for radio bearers for which a TBF was not requested, the mobile station shall not act upon these assignments. The mobile station shall act upon the valid assignments.

- If the MULTIPLE TBF UPLINK ASSIGNMENT message contains assignments such that more than one RB is mapped onto one TBF, then TBF failure has occurred for each of the RBs that are mapped onto the same TBF.
- If the mobile station has been assigned a TBF in EGPRS mode and the MS does not support EGPRS, or has been assigned an MCS (e.g. 8-PSK in the Uplink) that the MS does not support, the MS shall return to MAC-Idle state and notify higher layers (TBF establishment failure).
- On expiry of timer T3164, the mobile station shall reinitiate the packet access procedure for the related RB unless the packet access procedure has already been attempted four times for this RB, in which case the mobile station shall notify higher layers of TBF establishment failure. If the mobile station has no remaining TBFs it shall return to MAC-Idle state.
- If the failure is due to any other reason, the mobile station shall return to MAC-Idle state, notify higher layer (TBF establishment failure), transactions in progress shall be aborted and cell reselection continues.

7.3 TBF establishment initiated by the network on PCCCH

7.3.1 General

The purpose of network initiated TBF establishment is to establish a TBF to support the transfer of upper layer PDUs in the direction from the network to the mobile station. The procedure may be entered when the mobile station is in MAC-Idle state. Network initiated TBF establishment can also be done on PACCH if a TBF for transfer of upper layer PDUs in the direction from the mobile station to the network is already established (sub-clause 8.2.3.5).

If the mobile station is in MAC-Dedicated state the establishment of a TBF shall be performed by procedures that are specified in 3GPP TS 44.118.

7.3.2 Entering the MAC-Shared state

7.3.2.1 General

The procedure is triggered by a request from upper layers on the network side to transfer an upper layer PDU to a mobile station in MAC-Idle state. The request is implicit when receiving an upper layer PDU to a mobile station not already having any assigned radio resources. Upon such a request, the network shall initiate a packet downlink assignment procedure as defined in sub-clause 7.3.2.2.

7.3.2.2 Packet downlink assignment procedure

7.3.2.2.1 Packet downlink assignment procedure

See 3GPP TS 44.060 sub-clause 7.2.1.1.

7.3.2.2.2 HFN synchronization

If ciphering is used, the least significant bit of the downlink HFN of this radio bearer shall be inserted in the PACKET DOWNLINK ASSIGNMENT message sent in the packet downlink assignment procedure (see sub-clause 7.3.2.2.1). If the least significant bit of the HFN in the mobile station for the same radio bearer in the same direction is different from the one received from the network, the mobile station shall increase its HFN by one unit.

7.3.2.3 Packet downlink assignment procedure completion

See 3GPP TS 44.060 sub-clause 7.2.1.2.

7.3.2.4 Packet polling procedure

See 3GPP TS 44.060 sub-clause 7.2.1.3.

7.3.2.5 Abnormal cases

See 3GPP TS 44.060 sub-clause 7.2.2.

7.3.3 Entering the MAC-Dedicated state

7.3.3.1 General

The procedure is triggered by a request from upper layers on the network side to transfer an upper layer PDU to a mobile station in MAC-Idle state. The request is implicit when receiving an upper layer PDU to a mobile station not already having any assigned radio resources and the request requires dedicated resources. Upon such a request, the network shall initiate a packet DBPSCH assignment procedure as defined in sub-clause 7.3.3.2.

7.3.3.2 Packet DBPSCH assignment procedure

The network may assign a radio resource on one or more DBPSCHs to be used for the TBF. The amount of radio resources to be reserved is a network dependent choice. The network shall not assign radio resources on more than one DBPSCH/S to the TBF.

The allocated radio resource is assigned to the mobile station in a PACKET DBPSCH ASSIGNMENT message to the mobile station. The PACKET DBPSCH ASSIGNMENT message is transmitted on the PCCCH timeslot corresponding to the PCCCH group the mobile station belongs to. The appropriate PCCCH group is calculated from the IMSI (see 3GPP TS 45.002). The behaviour of the network when the IMSI is not provided by the upper layers is implementation dependent for the calculation of the PCCCH group where the PACKET DBPSCH ASSIGNMENT message has to be sent. If the mobile station is in non-DRX mode or if the IMSI or the DRX parameters are not provided by the upper layers, there is no further restriction on what part of the downlink PCCCH timeslot this PACKET DBPSCH ASSIGNMENT message can be sent, provided that this part corresponds to one or more blocks where paging may appear. If the mobile station applies DRX, this message shall be sent in one or more PCCCH block(s) corresponding to a paging group determined for the mobile station in MAC-Idle state (see 3GPP TS 45.002). The multislot capabilities of the mobile station shall be considered.

Initial timing advance can be provided in the PACKET DBPSCH ASSIGNMENT message as Timing Advance Value field. For the case where Timing Advance Value is not provided in the assignment message, the mobile station is not allowed to send normal bursts (e.g. PACKET DOWNLINK ACK/NACK message) on the uplink until it receives a valid timing advance on the SACCH.

The mobile station shall use information received on the PBCCH to decode the channel descriptions contained in the assignment. If frequency hopping is applied, the mobile station shall use the last CA received on PBCCH to decode the Mobile Allocation. Alternatively, the network may provide a Mobile Allocation in the assignment. The radio resource is assigned to the mobile station in a PACKET DBPSCH ASSIGNMENT message. On receipt of a PACKET DBPSCH ASSIGNMENT message, the mobile station shall switch to the assigned DBPSCHs.

If the mobile station receives more than one PACKET DBPSCH ASSIGNMENT message while it monitors the PCCCH, it shall act upon the most recently received message and shall ignore the previous message.

When the PACKET DBPSCH ASSIGNMENT message is received the mobile station shall switch to the assigned DBPSCH(s), start timer T3190 and enters the MAC-Dedicated state. The timer T3190 is restarted when receiving the first valid RLC data block addressed to itself.

When the mobile station switches to the assigned DBPSCHs, it shall take the power control parameters received in the PACKET DBPSCH ASSIGNMENT message into account, perform signal strength measurements and apply output power control procedures as they are defined for MAC-Dedicated state (see 3GPP TS 45.008).

On expiry of timer T3190, the mobile station shall abort the procedure and return to MAC-Idle state.

7.3.3.3 Packet DBPSCH assignment procedure completion

The Packet DBPSCH assignment procedure is completed when the mobile station receives a valid RLC/MAC block.

7.3.3.4 Packet polling procedure

On receipt of a control message with the poll bit set, the mobile station shall respond to the network with the PACKET CONTROL ACKNOWLEDGEMENT message.

7.3.3.5 Abnormal cases

If a failure occurs on the mobile station side of the new TBF before mobile station has successfully entered the MAC-Dedicated state, the newly reserved resources are released; the subsequent behaviour of the mobile station depends on the type of failure and previous actions.

- If the mobile station has been assigned more DBPSCHs than it supports according to its MS multislot class, the mobile station shall ignore the assignment and return to MAC-Idle state.
- If the mobile station has been assigned more than one DBPSCH/S, the mobile station shall ignore the assignment and return to MAC-Idle state
- On expiry of timer T3190, the mobile station shall return to MAC-Idle state.
- If the failure is due to any other reason, the mobile station shall ignore the assignment and return to MAC-Idle state and cell reselection continues.

7.4 Procedure for measurement report sending in MAC-Idle state

7.4.1 General

The procedure for measurement report sending shall be initiated by the mobile station at expiry of either the NC measurement report interval timer T3158 or the EM measurement report interval timer T3178. At expiry of the timer T3158 or T3178 the mobile station shall restart the expired timer T3158 or T3178, perform the measurements and initiate the packet access.

The procedure for measurement report sending is initiated by the mobile station on PCCCH (sub-clause 7.4.2).

If the mobile station initiates the establishment of a DBPSCH, the timers T3158 and T3178 shall be stopped and no measurement reports shall be sent. When the last DBPSCH is released and if the mobile station has not changed cell, the measurement reporting procedure shall be restarted.

If a cell change has occurred while the mobile station had one or more DBPSCHs allocated, the measurements shall be cancelled until new NC or EM-orders have been received (see sub-clause 5.5).

7.4.2 Measurement report sending procedure initiated on PCCCH

7.4.2.1 General

The packet access procedure is initiated by the MAC entity in the mobile station as specified in sub-clauses 7.2.3.1 and 7.2.3.2 but with access type "Single block without TBF establishment" indicated in the PACKET CHANNEL REQUEST message.

7.4.2.2 On receipt of a PACKET CHANNEL REQUEST message

See 3GPP TS 44.060 sub-clause 7.3.1.1.

7.4.2.3 On receipt of a PACKET UPLINK ASSIGNMENT message

See 3GPP TS 44.060 sub-clause 7.3.1.2.

7.4.2.4 On receipt of a PACKET ACCESS REJECT message

See 3GPP TS 44.060 sub-clause 7.3.1.3.

7.4.2.5 Abnormal cases

See 3GPP TS 44.060 sub-clause 7.3.1.4.

7.5 Cell Change Order procedures in MAC-Idle state

7.5.1 General

For an individual mobile station in MAC-Idle state, the network may initiate the cell change order procedure on PCCCH.

The network may initiate the cell change order procedure by sending a PACKET CELL CHANGE ORDER message in a PCCCH block monitored by the mobile station. No TBF shall be established.

The PACKET CELL CHANGE ORDER message contains:

- The characteristics of the new cell that are necessary to identify it (i.e. BSIC + BCCH frequency).
- The NC measurement parameters valid for the mobile station in the new cell (NETWORK_CONTROL_ORDER and optionally: NC_NON_DRX_PERIOD, NC_REPORTING_PERIOD_I and NC_REPORTING_PERIOD_T).

For a multi-RAT mobile station, the PACKET CELL CHANGE ORDER message may contain information on a 3G target cell; in the case of UTRAN, the establishment of channel(s) and subsequent measurement reporting are defined in 3GPP TS 25.331.

Upon receipt of the PACKET CELL CHANGE ORDER message, the mobile station shall stop all relevant RLC/MAC timers except for timers related to measurement reporting and start timer T3174. The mobile station shall then switch to the specified new cell and obey the relevant RLC/MAC procedures on this new cell. If a valid RRBP field was received in the PACKET CELL CHANGE ORDER message then the MS shall send a PACKET CONTROL ACKNOWLEDGMENT message in the reserved uplink radio block specified by the RRBP field before switching to the new cell. If the timers related to measurement reporting expire while the reselection procedure has not yet been completed, these timers shall be restarted so that the mobile station resumes the measurement reporting procedures once camped on the new cell. The mobile station shall obey the PACKET CELL CHANGE ORDER message irrespective of whether or not the mobile station has any knowledge of the relative synchronisation of the target cell to the serving cell. A UTRAN capable mobile station shall obey the command irrespective of whether the cell is known or not known (see 3GPP TS 25.133 and 3GPP TS 25.123).

The procedure for completion of the cell change order is defined in 3GPP TS 44.060 sub-clause 8.4.1 and abnormal procedures are defined in 3GPP TS 44.060 sub-clause 8.4.2.

7.6 Measurement Order procedures in MAC-Idle state

7.6.1 General

To send either the NC Measurement order or the Extended Measurement order to an individual mobile station in MAC-Idle state, the network may establish a connection on PCCCH.

NOTE: This procedure is under the control of RRC and is only applicable when the MS is in RRC Cell Shared State.

7.6.2 Measurement Order procedures initiated on PCCCH

See 3GPP TS 44.060 sub-clause 7.5.1.

8 Medium Access Control (MAC) procedures on SBPSCH

8.1 General

The MAC procedures defined in this sub-clause are applicable in MAC-Shared state and MAC-DTM state.

The full set of downlink assignment messages comprises the PACKET DOWNLINK ASSIGNMENT, PACKET TIMESLOT RECONFIGURE, MULTIPLE TBF DOWNLINK ASSIGNMENT and MULTIPLE TBF TIMESLOT RECONFIGURE messages.

The full set of uplink assignment messages comprises the PACKET UPLINK ASSIGNMENT, PACKET TIMESLOT RECONFIGURE, MULTIPLE TBF UPLINK ASSIGNMENT and MULTIPLE TBF TIMESLOT RECONFIGURE messages.

The network may choose to send either single assignment messages (PACKET UPLINK ASSIGNMENT, PACKET DOWNLINK ASSIGNMENT, PACKET TIMESLOT RECONFIGURE) or multiple TBF assignment messages (MULTIPLE TBF DOWNLINK ASSIGNMENT, MULTIPLE TBF UPLINK ASSIGNMENT, MULTIPLE TBF TIMESLOT RECONFIGURE) on the PACCH. The network shall only use the multiple TBF assignment messages when assigning or reallocating the mobile station with more than one uplink TBF and/or more than one downlink TBF.

8.1a Resource stealing (SFACCH)

The use of SFACCH in MAC-Shared state for SRBs 1 through 4 is specified in sub-clause 5.6.2.2.

The use of SFACCH in MAC-DTM state for SRBs 3 and 4 is specified in sub-clause 5.6.2.3. SFACCH shall not be used for SRBs 1 and 2 in MAC-DTM state.

If the mobile station has data to send for an SRB that can be sent on SFACCH, and neither a TBF nor a TBF establishment request is ongoing for this SRB, the following procedure applies:

- The mobile station may select a current TBF on an SBPSCH, construct an uplink RLC data block that includes octet 3 (this octet contains the SRBId), and send the SRB data at the TBF's next scheduled transmission opportunity for an RLC data block. GERAN shall use the SRBId to route the SRB data to the correct RLC instance.
- Otherwise, the mobile station shall initiate a new TBF operating on an SBPSCH (see sub-clause 8.2.2.0.2).

If the mobile station has data to send for an SRB, and a TBF exists for this SRB, the following procedure applies:

- The mobile station shall construct an uplink RLC data block that does not include octet 3 and send the SRB data on the TBF.

If GERAN has data to send for an SRB that can be sent on SFACCH, and no TBF exists for this SRB, the following procedure applies:

- GERAN may select a current TBF on an SBPSCH, construct a downlink RLC data block that includes octet 3, and send the SRB data at the TBF's next scheduled transmission opportunity for an RLC data block. The mobile station shall use the SRBId to route the SRB data to the correct RLC instance.
- Otherwise, GERAN shall establish a new TBF operating on an SBPSCH (see sub-clause 8.2.2.0.2).

If GERAN has data to send for an SRB, and a TBF exists for this SRB, the following procedure applies:

- GERAN shall construct a downlink RLC data block that does not include octet 3 and send the SRB data on the TBF.

8.2 Transfer of RLC data blocks

8.2.1 Medium access mode

The transfer of RLC data blocks on SBPSCH is governed by different principles on both uplink and downlink for each of the defined medium access modes: dynamic allocation, extended dynamic allocation, and exclusive allocation.

The medium access mode the mobile station is to use, except when exclusive allocation is applied in MAC-DTM state, is given by the MAC_MODE parameter. The MAC_MODE parameter is included in the downlink assignment (e.g. PACKET DOWNLINK ASSIGNMENT or PACKET TIMESLOT RECONFIGURE) message, whereas in the uplink the MAC_MODE parameter is given by the EXTENDED_DYNAMIC_ALLOCATION parameter. The value of the MAC_MODE parameter shall not be changed while the mobile station is in MAC-Shared state or MAC-DTM state.

Exclusive allocation is applicable only in MAC-DTM state when a single TBF is allocated on a half-rate PDCH.

When the conditions for exclusive allocation are fulfilled, the mobile station shall store the value of the MAC_MODE parameter. The MAC_MODE parameter has no effect as long as exclusive allocation is used. When the conditions for exclusive allocation are not fulfilled, the mobile station shall use the medium access mode given by the value of the MAC_MODE parameter.

8.2.2 Uplink RLC data block transfer

8.2.2.0 General

8.2.2.0.1 General

See 3GPP TS 44.060 sub-clause 8.1.1.

8.2.2.0.2 Establishment of additional uplink TBF(s)

When the mobile station has data to send that does not have the same radio bearer identity as (any of) the uplink TBF(s) or TBF request(s) in progress, the mobile station shall request uplink resources through one of the following procedures:

- If the data belongs to a signalling radio bearer
 - Use the SFACCH (see sub-clause 8.1a)
 - Establish an additional TBF (sub-clause 8.2.2.1.2)
 - If the mobile station cannot support the establishment of an additional TBF, then the network may release an on-going TBF in order to establish a new TBF (sub-clause 8.2.2.1.2)
- If the data belongs to a user radio bearer
 - Establish an additional TBF (sub-clause 8.2.2.1.2)
 - If the mobile station cannot support the establishment of an additional TBF, then the network may release an on-going TBF in order to establish a new TBF (sub-clause 8.2.2.1.2)

8.2.2.0.3 Uplink resource reallocation / reconfiguration

Neither the mobile station nor the network are allowed to modify the RLC mode, TBF mode or radio bearer identity of an already established TBF. If the mobile station has data to send that requires a modification of existing uplink resources, an uplink resource request shall be sent, see sub-clause 8.2.2.0.2.

If no modifications to the uplink resources are required, the network may reallocate existing resources through one of the following procedures:

- The network may send a PACKET TIMESLOT RECONFIGURE or MULTIPLE TBF TIMESLOT RECONFIGURE message to the mobile station on the PACCH to reallocate uplink (and also downlink) resources, see sub-clause 8.2.2.1.2.2.
- The network may send a PACKET UPLINK ASSIGNMENT or MULTIPLE TBF UPLINK ASSIGNMENT message to the mobile station on the PACCH to reallocate uplink resources, see sub-clause 8.2.2.1.2.2.

8.2.2.0.4 Establishment of downlink TBF(s)

During uplink data transfer, the network may initiate downlink data transfer for one or more TBFs by sending a downlink assignment message to the mobile station on the downlink PACCH.

The network initiates assignment of a single downlink TBF by sending a PACKET DOWNLINK ASSIGNMENT or a PACKET TIMESLOT RECONFIGURE message. The network initiates assignment of more than one downlink TBF by sending a MULTIPLE TBF DOWNLINK ASSIGNMENT or a MULTIPLE TBF TIMESLOT RECONFIGURE message.

The procedure to be followed is described in sub-clause 8.2.2.1.3.

8.2.2.1 Dynamic Allocation uplink RLC data block transfer

See 3GPP TS 44.060 sub-clause 8.1.1.1.

8.2.2.1.1 PACCH operation

See 3GPP TS 44.060 sub-clause 8.1.1.1.1.

8.2.2.1.2 Resource Allocation / Reallocation for Uplink

8.2.2.1.2.1 General

The mobile station shall initiate the uplink resource (re)allocation procedure by sending a PACKET RESOURCE REQUEST message on the PACCH and starting timer T3168 for each TBF request included in the Iu mode Channel Request Description IE.

8.2.2.1.2.2 On receipt of the PACKET RESOURCE REQUEST

On receipt of the PACKET RESOURCE REQUEST message the network shall respond by sending one or more uplink assignment messages (e.g. PACKET UPLINK ASSIGNMENT, MULTIPLE TBF UPLINK ASSIGNMENT, MULTIPLE TBF TIMESLOT RECONFIGURE or PACKET TIMESLOT RECONFIGURE) and/or a PACKET ACCESS REJECT message and/or a PACKET TBF RELEASE message to the mobile station on the downlink PACCH.

When the mobile station has already been allocated the maximum number of TBFs in the uplink direction that it can support, the network shall respond with either a PACKET ACCESS REJECT message, or a PACKET TBF RELEASE message followed by an uplink assignment message.

On receipt of an uplink assignment message the mobile station shall stop timer T3168 for each uplink TBF assigned in the assignment message and switch to the assigned SBPSCHs. A new assignment shall not terminate the previous assignment unless the uplink assignment message explicitly contains a reassignment for an on-going TBF.

On expiry of timer T3168 the mobile station shall retransmit the PACKET RESOURCE REQUEST message for the TBF(s) for which T3168 has expired unless the PACKET RESOURCE REQUEST message has already been transmitted four times for this TBF in which case the mobile station shall indicate a packet access failure to upper layer and perform an abnormal release without retry (see sub-clause 8.7.1).

If no uplink assignment message is received for a TBF for which timer T3168 is running before the mobile station has completed its currently assigned TBF(s), the mobile station shall stop timer T3168 for that TBF, return to MAC-Idle state and start the packet access procedure on the PCCCH.

The network may at any time during an uplink TBF initiate a change of resources or allocation of new resources by sending on the downlink PACCH monitored by the MS, an unsolicited uplink assignment message to the mobile station.

On receipt of a PACKET ACCESS REJECT message, the mobile station shall stop timer T3168, if running, for each TBF request rejected in the PACKET ACCESS REJECT message and indicate a packet access failure to the upper layer. If no other uplink or downlink TBFs exist, the mobile station in MAC-Shared state shall return to MAC-Idle state; the mobile station in MAC-DTM state shall return to MAC-Dedicated state. The DRX mode procedures shall be applied, as specified in sub-clause 5.5.1.5.

If the PACKET ACCESS REJECT message contains a WAIT_INDICATION field in a Reject structure addressed to the mobile station, the mobile station shall

- start timer T3172 for each TBF request rejected in the message (listed by radio bearer identity). The mobile station is not allowed to make a new attempt for an uplink TBF establishment for this radio bearer in the same cell until this instance of timer T3172 expires. It may attempt a TBF establishment for another radio bearer while T3172 is running. It may attempt an uplink TBF establishment in another cell after successful cell reselection. While T3172 is running, the mobile station shall ignore all received PACKET PAGING REQUEST messages.

The value of the WAIT_INDICATION field (i.e. timer T3172) relates to the cell from which it was received.

8.2.2.1.2.3 Abnormal cases

The following abnormal cases apply:

- If the mobile station receives a PACKET UPLINK ASSIGNMENT, MULTIPLE TBF UPLINK ASSIGNMENT, PACKET TIMESLOT RECONFIGURE or MULTIPLE TBF TIMESLOT RECONFIGURE message and detects an invalid Frequency Parameters information element in the message, the mobile station shall perform an abnormal release with system information (see sub-clause 8.8.4), performing a partial acquisition of system information messages containing frequency information.
- If the information in the PACKET UPLINK ASSIGNMENT or MULTIPLE TBF UPLINK ASSIGNMENT message incorrectly specifies one or more uplink PDCHs, the mobile station shall perform an abnormal release with access retry of the uplink TBF(s) with erroneous assignments (see sub-clause 8.8.5). The mobile station shall act upon the valid assignments.
- If the information in the PACKET TIMESLOT RECONFIGURE or MULTIPLE TBF TIMESLOT RECONFIGURE message incorrectly specifies one or more uplink and/or downlink PDCHs, the mobile station shall perform an abnormal release with access retry of the uplink TBF(s) with erroneous assignments (see sub-clause 8.8.5). The mobile station shall act upon the valid assignments.
- If the information in the PACKET UPLINK ASSIGNMENT, MULTIPLE TBF UPLINK ASSIGNMENT, PACKET TIMESLOT RECONFIGURE or MULTIPLE TBF TIMESLOT RECONFIGURE message violates the mobile station's multislot capabilities, the mobile station shall perform an abnormal release with access retry (see sub-clause 8.8.3).
- If the mobile station receives a PACKET UPLINK ASSIGNMENT, MULTIPLE TBF UPLINK ASSIGNMENT, PACKET TIMESLOT RECONFIGURE or MULTIPLE TBF TIMESLOT RECONFIGURE message specifying frequencies that are not all in one frequency band then the mobile station shall perform an abnormal release with access retry (see sub-clause 8.8.3).
- If the mobile station receives a PACKET UPLINK ASSIGNMENT or MULTIPLE TBF UPLINK ASSIGNMENT message containing a Frequency Parameters information element specifying a frequency that is in a frequency band not supported by the mobile station then the mobile station shall perform an abnormal release with access retry (see sub-clause 8.8.3).
- If the mobile station receives a PACKET UPLINK ASSIGNMENT, MULTIPLE TBF UPLINK ASSIGNMENT, PACKET TIMESLOT RECONFIGURE or MULTIPLE TBF TIMESLOT RECONFIGURE message containing assignments such that more than one radio bearer is mapped onto one TBF, then the mobile station shall perform an abnormal release with access retry (see sub-clause 8.8.3).
- If the PACKET UPLINK ASSIGNMENT, MULTIPLE TBF UPLINK ASSIGNMENT, PACKET TIMESLOT RECONFIGURE, or MULTIPLE TBF TIMESLOT RECONFIGURE message assigns the same USF to more than one TBF on the same timeslot, then the mobile station shall perform an abnormal release with access retry (sub-clause 8.8.3).
- If the PACKET UPLINK ASSIGNMENT, MULTIPLE TBF UPLINK ASSIGNMENT, PACKET TIMESLOT RECONFIGURE or MULTIPLE TBF TIMESLOT RECONFIGURE message specifies a RB Id that is not

assigned to the mobile station, then the mobile station shall perform an abnormal release with access retry (sub-clause 8.8.3).

- If a mobile station in MAC-DTM state receives a PACKET UPLINK ASSIGNMENT, MULTIPLE TBF UPLINK ASSIGNMENT, PACKET TIMESLOT RECONFIGURE or MULTIPLE TBF TIMESLOT RECONFIGURE message including the Frequency Parameters information element, the mobile station shall perform an abnormal release with access retry (see sub-clause 8.8.3).
- If the MULTIPLE TBF UPLINK ASSIGNMENT or MULTIPLE TBF TIMESLOT RECONFIGURE message does not specify a Channel Coding scheme for one or more of the uplink TBFs that it is assigning, then the mobile station shall perform an abnormal release with access retry of the uplink TBFs with erroneous assignments (see sub-clause 8.8.5). The mobile station shall act upon the valid assignments.
- If the PACKET ACCESS REJECT message does not specify a G-RNTI_extension field in the Iu mode Reject structure for each G-RNTI included in the TLLI / G-RNTI field in the Reject structure, then the mobile station shall ignore the message.
- If the PACKET ACCESS REJECT message includes one or more RB Id fields in the Iu mode Reject structure which were not included by the mobile station in the Iu mode Channel Request Description structure, then the mobile station shall perform abnormal release with access retry (see sub-clause 8.8.3).
- If a failure in the PACKET UPLINK ASSIGNMENT, MULTIPLE TBF UPLINK ASSIGNMENT, PACKET TIMESLOT RECONFIGURE or MULTIPLE TBF TIMESLOT RECONFIGURE message is due to any other reason, the mobile station shall perform an abnormal release with access retry (see sub-clause 8.8.3).

A PACKET UPLINK ASSIGNMENT, MULTIPLE TBF UPLINK ASSIGNMENT, PACKET TIMESLOT RECONFIGURE or MULTIPLE TBF TIMESLOT RECONFIGURE message received by a multi-band mobile station shall not be considered invalid if it indicates new frequencies that are all in a different frequency band to that of the PDCH(s) on which the assignment was received. The assignment may however be rendered invalid for some other reason.

8.2.2.1.3 Establishment of downlink TBF

8.2.2.1.3.1 General

During uplink transfer, the network may initiate one or more downlink TBFs by sending a downlink assignment message (e.g. PACKET DOWNLINK ASSIGNMENT, PACKET TIMESLOT RECONFIGURE, MULTIPLE TBF DOWNLINK ASSIGNMENT, MULTIPLE TBF TIMESLOT RECONFIGURE) to the mobile station on the PACCH.

If a PACKET TIMESLOT RECONFIGURE message is sent, then the message shall contain the DOWNLINK_TFI_ASSIGNMENT field. The multislot restrictions of the mobile station shall be observed.

A mobile allocation or reference frequency list, received as part of a downlink assignment, replaces the previous parameters and shall be used until a new assignment is received or the mobile station has released all TBFs.

On receipt of a downlink assignment message, and after the TBF starting time, if present, the mobile station shall switch to the assigned SBPSCHs, and start timer T3190 for each TBF. The operation of the downlink TBF follows the procedures in sub-clause 8.2.3 and 3GPP TS 44.060 sub-clause 8.1.2 with the following additions:

- the mobile station shall prioritise transmission of RLC/MAC control blocks associated with the downlink TBF over RLC/MAC control blocks associated with the uplink TBF;
- if a timer or counter expiry causes the uplink TBF to be aborted in the mobile station triggering an abnormal release with access retry on PCCCH (see sub-clause 8.8.3), the mobile station shall also abort all downlink TBF(s). The mobile station shall not abort the downlink TBF(s) in case an abnormal release with access retry on PACCH is triggered;
- If both uplink and downlink TBFs are already established and if more than one TBF is already established in either/both direction(s), then the network may send a MULTIPLE TBF TIMESLOT RECONFIGURE message. If this message contains a change in frequency in the frequency parameters and does not contain a reassignment for one or more of the mobile station's TBFs, these TBFs are to be released upon moving to the new frequency. If no change in frequency parameters is included, the TBFs not explicitly reconfigured shall continue according to their original assignment.

8.2.2.1.3.2 Abnormal cases

In the following abnormal cases it is assumed that at least one uplink TBF exists. The subsequent behaviour of the mobile station depends on the type of failure and previous actions:

- If the information in the PACKET TIMESLOT RECONFIGURE or MULTIPLE TBF TIMESLOT RECONFIGURE message incorrectly specifies an uplink and/or downlink PDCH, the mobile station shall perform an abnormal release of the downlink TBF(s) with erroneous assignments (see sub-clause 8.8.6). The mobile station shall act upon the valid assignments.
- If the information in the PACKET TIMESLOT RECONFIGURE or MULTIPLE TBF TIMESLOT RECONFIGURE message violates the mobile station's multislot capabilities, the mobile station shall perform an abnormal release with access retry (see sub-clause 8.8.3).
- If a downlink TBF is not already established and the PACKET TIMESLOT RECONFIGURE message does not include a DOWNLINK_TFI_ASSIGNMENT field, then the mobile station shall perform an abnormal release with access retry (sub-clause 8.8.3).
- If a downlink TBF is not already established and the MULTIPLE TBF TIMESLOT RECONFIGURE message does not assign any downlink TBFs, then the mobile station shall perform an abnormal release with access retry (sub-clause 8.8.3).
- If the mobile station receives a PACKET DOWNLINK ASSIGNMENT, MULTIPLE TBF DOWNLINK ASSIGNMENT, PACKET TIMESLOT RECONFIGURE or MULTIPLE TBF TIMESLOT RECONFIGURE message containing assignments such that more than one radio bearer is mapped onto a TBF, then the mobile station shall perform an abnormal release with access retry (see sub-clause 8.8.3).
- If the PACKET DOWNLINK ASSIGNMENT, MULTIPLE TBF DOWNLINK ASSIGNMENT, PACKET TIMESLOT RECONFIGURE or MULTIPLE TBF TIMESLOT RECONFIGURE message specifies a RB Id not assigned to the mobile station, then the mobile station shall perform an abnormal release with access retry (sub-clause 8.8.3).
- If a mobile station in MAC-DTM state receives a PACKET DOWNLINK ASSIGNMENT, MULTIPLE TBF DOWNLINK ASSIGNMENT, PACKET TIMESLOT RECONFIGURE or MULTIPLE TBF TIMESLOT RECONFIGURE message including the Frequency Parameters information element, the mobile station shall perform an abnormal release with access retry (sub-clause 8.8.3).
- If a failure in the PACKET DOWNLINK ASSIGNMENT, MULTIPLE TBF DOWNLINK ASSIGNMENT, PACKET TIMESLOT RECONFIGURE or MULTIPLE TBF TIMESLOT RECONFIGURE message is due to any other reason, the mobile station shall abort the procedure. If other uplink TBFs exist, the mobile station shall perform an abnormal release with access retry (sub-clause 8.8.3). If only downlink TBFs exist, the mobile station shall continue the normal operation of these TBFs. If no other TBFs exist, the mobile station shall perform an abnormal release without retry (see sub-clause 8.8.2).

8.2.2.2 Extended Dynamic Allocation uplink RLC data block transfer

8.2.2.2.0 General

The Extended Dynamic Allocation medium access method extends the Dynamic Allocation medium access method to allow higher uplink throughput.

This sub-clause defines the extensions to the Dynamic Allocation medium access method. All procedures defined in sub-clause 8.2.2.1 apply, except where this sub-clause defines a new procedure. In cases where this sub-clause conflicts with sub-clause 8.2.2.1, this sub-clause takes precedence.

8.2.2.2.1 Uplink PDCH Allocation

See 3GPP TS 44.060 sub-clause 8.1.1.2.1.

8.2.2.2.2 PACCH operation

See 3GPP TS 44.060 sub-clause 8.1.1.2.2.

8.2.2.2.3 Neighbour cell power measurements

See 3GPP TS 44.060 sub-clause 8.1.1.2.3.

8.2.2.3 Exclusive Allocation uplink RLC data block transfer

See 3GPP TS 44.060 sub-clause 8.1.1.3a.

8.2.2.3.1 (void)

8.2.2.3.2 (void)

8.2.2.3.3 (void)

8.2.2.3.4 (void)

8.2.2.3.5 (void)

8.2.2.3.6 (void)

8.2.2.4 Network initiated release of uplink TBF

See 3GPP TS 44.060 sub-clause 8.1.1.4.

8.2.2.5 Abnormal cases

The following additional abnormal cases are applicable to an uplink transfer:-

- if the mobile station receives a PACKET UPLINK ACK/NACK message with missing mandatory fields, the mobile station shall perform an abnormal release with access retry of the uplink TBF (sub-clause 8.8.5) associated with this message.
- if the mobile station receives a PACKET UPLINK ACK/NACK message that contains a RB Id that is not assigned to the mobile station or that is assigned to the mobile station but without any corresponding uplink TBF, the mobile station shall perform an abnormal release with access retry (sub-clause 8.8.3).

8.2.3 Downlink RLC data block transfer

8.2.3.1 General

8.2.3.1.0 General

The network initiates assignment of a single downlink TBF by sending a PACKET DOWNLINK ASSIGNMENT or a PACKET TIMESLOT RECONFIGURE message on the downlink PACCH. The network initiates assignment of more than one downlink TBF by sending a MULTIPLE TBF DOWNLINK ASSIGNMENT or a MULTIPLE TBF TIMESLOT RECONFIGURE message on the downlink PACCH. Prior to the initiation of RLC data block transfer on the downlink, the network assigns the following parameters to the downlink TBF in the downlink assignment message:

- a Temporary Flow Identity (TFI). The TFI applies to all radio blocks transferred in regards to the downlink Temporary Block Flow (TBF).
- a radio bearer identity (RB Id). There is a one-to-one mapping between the TFI and the RB Id of the radio bearer for which the downlink TBF is established.
- a set of PDCHs to be used for the downlink transfer;
- optionally, a TBF starting time indication.

For each TBF, the network shall prioritise RLC/MAC control blocks, not containing a PACKET DOWNLINK DUMMY CONTROL BLOCK message, to be transmitted ahead of RLC data blocks for that TBF. If the network has no other RLC/MAC block to transmit, but wishes to transmit on the downlink, the network shall transmit an RLC/MAC control block containing a PACKET DOWNLINK DUMMY CONTROL BLOCK message.

8.2.3.1.1 Downlink resource reallocation

Neither the mobile station nor the network are allowed to modify the RLC mode, TBF mode or radio bearer identity of an already established TBF.

If no modifications to the downlink resources are required, the network may reallocate existing resources through one of the following procedures:

- The network may send a PACKET TIMESLOT RECONFIGURE or MULTIPLE TBF TIMESLOT RECONFIGURE message to the mobile station on the PACCH to reallocate downlink (and also uplink) resources, see sub-clause 8.2.3.2.
- The network may send a PACKET DOWNLINK ASSIGNMENT or MULTIPLE TBF DOWNLINK ASSIGNMENT message to the mobile station on the PACCH to reallocate downlink resources, see sub-clause 8.2.3.2.

8.2.3.1.2 (void)

8.2.3.2 Downlink RLC data block transfer procedure

8.2.3.2.0 General

Upon reception of a downlink assignment message (e.g. PACKET DOWNLINK ASSIGNMENT, PACKET TIMESLOT RECONFIGURE, MULTIPLE TBF DOWNLINK ASSIGNMENT, MULTIPLE TBF TIMESLOT RECONFIGURE) that does not contain a TBF starting time the mobile station shall start timer T3190 for each downlink TBF assigned in the downlink assignment message and, within the reaction time defined in 3GPP TS 45.010, it shall attempt to decode every downlink block on its assigned SBPSCH(s). If the downlink assignment message contains a TBF starting time information element and there are no downlink TBFs in progress, but one or more uplink TBFs are in progress, the mobile station shall remain on the assigned SBPSCHs until the TDMA frame number indicated by the TBF starting time, at which time the mobile station shall start timer T3190 for each downlink TBF assigned in the downlink assignment message and immediately begin decoding the assigned downlink SBPSCH(s).

If the downlink assignment message contains a TBF starting time and there are one or more downlink TBFs already in progress, the mobile station shall continue to use the parameters of the downlink TBFs in progress until the TDMA frame number indicated in the TBF starting time occurs, at which time the mobile station shall immediately begin to use the new assigned downlink TBF parameters. If, while waiting for the frame number indicated by the TBF starting time, the mobile station receives another downlink assignment for the same TBF, the mobile station shall act upon the most recently received downlink assignment and shall ignore the previous downlink assignment. Procedures on receipt of a downlink assignment message (e.g. PACKET DOWNLINK ASSIGNMENT message) while no TBF is in progress are specified in sub-clause sub-clause 7.3.2.1 and 3GPP TS 44.060 sub-clause 7.2.1.1.

If the mobile station receives a valid RLC data block addressed to (one of) its TBF(s), the mobile station shall restart timer T3190 for that TBF. If timer T3190 expires for a TBF and if one or more uplink TBFs are in progress, the mobile station shall perform an abnormal release with access retry (see sub-clause 8.8.3, 3GPP TS 44.060 sub-clause 8.7.2). If no other TBFs are in progress, the mobile station shall perform an abnormal release without retry (see sub-clause 8.7.1).

Upon receipt of a PACKET TBF RELEASE message referring to the downlink TBF, the mobile station shall follow the procedure in sub-clause 8.1.2.8.

8.2.3.2.1 Abnormal cases

The following abnormal cases apply:

- If a mobile station receives a PACKET TIMESLOT RECONFIGURE, MULTIPLE TBF TIMESLOT RECONFIGURE, PACKET DOWNLINK ASSIGNMENT or MULTIPLE TBF DOWNLINK ASSIGNMENT PACKET DOWNLINK ASSIGNMENT or PACKET TIMESLOT RECONFIGURE message and detects an invalid Frequency Parameters information element in the message, it shall perform an abnormal release with

system information (see sub-clause 8.8.4), performing a partial acquisition of system information messages containing frequency information.

- If the information in the PACKET DOWNLINK ASSIGNMENT or MULTIPLE TBF DOWNLINK ASSIGNMENT message incorrectly specifies one or more downlink PDCHs, the mobile station shall perform an abnormal release of the downlink TBF(s) with erroneous assignments (see sub-clause 8.8.6). The mobile station shall act upon the valid assignments.
- If the information in the PACKET TIMESLOT RECONFIGURE or MULTIPLE TBF TIMESLOT RECONFIGURE message incorrectly specifies one or more uplink and/or downlink PDCHs, the mobile station shall perform an abnormal release of the downlink TBF(s) with erroneous assignments (see sub-clause 8.8.6). The mobile station shall act upon the valid assignments.
- If the information in the PACKET DOWNLINK ASSIGNMENT, MULTIPLE TBF DOWNLINK ASSIGNMENT, PACKET TIMESLOT RECONFIGURE or MULTIPLE TBF TIMESLOT RECONFIGURE message violates the mobile station's multislot capabilities, the mobile station shall perform an abnormal release without retry (see sub-clause 8.8.2).
- If a mobile station in MAC-DTM state receives a PACKET DOWNLINK ASSIGNMENT or MULTIPLE TBF DOWNLINK ASSIGNMENT message including the Frequency Parameters information element, the mobile station shall abort the procedure. If another TBF exists on a SBPSCH, the mobile station shall continue the normal operation of these TBFs. If no other TBF exists, the mobile station shall perform an abnormal release without retry (see sub-clause 8.8.2).
- If a mobile station in MAC-DTM state receives a PACKET TIMESLOT RECONFIGURE or MULTIPLE TBF TIMESLOT RECONFIGURE message including the Frequency Parameters information element, the mobile station shall perform an abnormal release without retry (see sub-clause 8.8.2).
- If one or more uplink TBFs are already established and the mobile station receives a PACKET DOWNLINK ASSIGNMENT or MULTIPLE TBF DOWNLINK ASSIGNMENT message containing different frequency parameters than are currently in effect for the uplink TBF(s), the mobile station shall ignore the received message and continue normal operation of the existing TBFs.
- If a downlink TBF is not already established and the PACKET TIMESLOT RECONFIGURE message does not include a DOWNLINK_TFI_ASSIGNMENT field, then the mobile station shall perform an abnormal release without retry (sub-clause 8.8.2).
- If a downlink TBF is not already established and the MULTIPLE TBF TIMESLOT RECONFIGURE message does not assign any downlink TBFs, then the mobile station shall perform an abnormal release without retry (sub-clause 8.8.2).
- If the mobile station receives a PACKET DOWNLINK ASSIGNMENT, MULTIPLE TBF DOWNLINK ASSIGNMENT, PACKET TIMESLOT RECONFIGURE or MULTIPLE TBF TIMESLOT RECONFIGURE message containing assignments such that more than one radio bearer is mapped onto a TBF, then the mobile station shall perform an abnormal release without retry (see sub-clause 8.8.2).
- If the PACKET DOWNLINK ASSIGNMENT, MULTIPLE TBF DOWNLINK ASSIGNMENT, PACKET TIMESLOT RECONFIGURE or MULTIPLE TBF TIMESLOT RECONFIGURE message specifies an RB Id that is not assigned to the mobile station, then the mobile station shall perform an abnormal release without retry (sub-clause 8.8.2).
- If the mobile station receives a PACKET DOWNLINK ASSIGNMENT, MULTIPLE TBF DOWNLINK ASSIGNMENT message so that the total amount of downlink TBFs assigned to the mobile station (i.e. new and existing TBFs) is larger than the maximum number of downlink TBFs the mobile station supports, the mobile station shall ignore the message and continue normal operation of the existing TBFs.
- If the mobile station receives a PACKET TIMESLOT RECONFIGURE or MULTIPLE TBF TIMESLOT RECONFIGURE message so that the total amount of TBFs assigned to the mobile station (i.e. new and existing TBFs) in any direction is larger than the maximum number of TBFs the mobile station supports in any direction, the mobile station shall perform an abnormal release with access retry (sub-clause 8.8.3).
- If a failure in the PACKET DOWNLINK ASSIGNMENT, MULTIPLE TBF DOWNLINK ASSIGNMENT, PACKET TIMESLOT RECONFIGURE or MULTIPLE TBF TIMESLOT RECONFIGURE message is due to any other reason, the mobile station shall abort the procedure. If other uplink TBFs exist, the mobile station shall

perform an abnormal release with access retry (sub-clause 8.8.3). If only downlink TBFs exist, the mobile station shall continue the normal operation of these TBFs. If no other TBFs exist, the mobile station shall perform an abnormal release without retry (see sub-clause 8.8.2).

8.2.3.3 Polling for Packet Downlink Ack/Nack

Whenever the mobile station receives an RLC data block addressed to (one of) its TBF(s) with a valid RRBP field in the RLC data block header (i.e. is polled), the mobile station may transmit a (EGPRS) PACKET DOWNLINK ACK/NACK message in the uplink radio block specified by the RRBP field whatever the BSN value of the received RLC data block, unless another RLC/MAC control message is waiting to be transmitted, in which case the other RLC/MAC control message shall be sent. Among the other RLC/MAC control blocks the PACKET CELL CHANGE NOTIFICATION message shall be sent with highest priority. However, the mobile station shall transmit an RLC/MAC control message other than a (EGPRS) PACKET DOWNLINK ACK/NACK message at most every second time it is polled for that TBF. Furthermore the mobile station shall not transmit an RLC/MAC control message other than a (EGPRS) PACKET DOWNLINK ACK/NACK message if the (EGPRS) PACKET DOWNLINK ACK/NACK message contains a Final Ack Indicator or Iu mode Channel Request Description IE. The mobile station shall not send a PACKET CONTROL ACKNOWLEDGEMENT message unless otherwise specified.

In EGPRS TBF mode the mobile station shall react on a poll inside an erroneously received RLC data block for which the header is correctly received and which addresses the mobile station.

Whenever the network receives a valid RLC/MAC control message from the TBF, it shall reset counter N3105. The network shall increment counter N3105 for each radio block allocated to that TBF with the RRBP field, for which no RLC/MAC control message is received. If $N3105 = N3105_{max}$, the network shall release the downlink TBF internally and start timer T3195 for that TBF. When T3195 expires, the network may reuse the TFI.

The PACKET DOWNLINK ACK/NACK message contains a Channel Quality Report (see 3GPP TS 45.008). The optional I_LEVEL measurement results shall be included in at least every other PACKET DOWNLINK ACK/NACK message.

The EGPRS PACKET DOWNLINK ACK/NACK message may contain an EGPRS Channel Quality Report (see 3GPP TS 45.008).

In the case of simultaneous uplink and downlink TBFs, the transmission of the polling response takes precedence over the transmission of allocated uplink radio blocks.

A mobile station of multislot class 1 to 12 need not respond to the poll if it is not compliant with the mobile station's multislot class (see 3GPP TS 45.002).

A mobile station of multislot class 13 to 18 shall always respond to the poll.

NOTE: The mobile station is required to make neighbour cell measurements while transmitting the polling response (see 3GPP TS 45.008).

8.2.3.4 Resource Reassignment for downlink

The network initiates downlink resource reassignment by sending a downlink assignment message (e.g. PACKET DOWNLINK ASSIGNMENT, PACKET TIMESLOT RECONFIGURE, MULTIPLE TBF DOWNLINK ASSIGNMENT or MULTIPLE TBF TIMESLOT RECONFIGURE) to the mobile station on the PACCH.

If the mobile station has a TBF for which T3192 is running, the network may choose to reallocate this existing TBF and reuse the TFI value for the new data by setting the Control Ack bit to '1' as specified in 3GPP TS 44.060 sub-clauses 9.3.2.6 and 9.3.3.5.

On receipt of a downlink assignment message and after the TBF starting time, if present, the mobile station shall switch to the assigned SBPSCHs. Upon switching to the new SBPSCHs the mobile station shall restart timer T3190 for each newly assigned downlink TBF.

When the mobile station receives an RLC/MAC block addressed to (one of) its TBF(s) on any of the new assigned resources it shall restart timer T3190 for the TBF. If timer T3190 expires, the mobile station shall perform an abnormal release without retry (see sub-clause 8.7.1).

8.2.3.5 Establishment of uplink TBF

8.2.3.5.0 General

The mobile station initiates the packet access procedure by sending the Iu mode Channel Request Description information element in the (EGPRS) PACKET DOWNLINK ACK/NACK message on the PACCH and starting timer T3168 for each TBF requested.

On receipt of an Iu mode Channel Request Description information element in the (EGPRS) PACKET DOWNLINK ACK/NACK message, the network may assign radio resources to the mobile station on one or more SBPSCHs by transmitting an uplink assignment (e.g. PACKET UPLINK ASSIGNMENT, PACKET TIMESLOT RECONFIGURE, MULTIPLE TBF UPLINK ASSIGNMENT or MULTIPLE TBF TIMESLOT RECONFIGURE) message on the PACCH, or may reject the request by sending a PACKET ACCESS REJECT message on the PACCH. If the PACKET TIMESLOT RECONFIGURE message is sent, then the message shall contain the UPLINK_TFI_ASSIGNMENT field.

A mobile allocation or reference frequency list, when received in the Frequency Parameters IE, as part of an uplink assignment, replaces the previous parameters and shall be used until a new assignment is received or the mobile station has released all TBFs.

On receipt of an uplink assignment message the mobile station shall follow the procedure below. On reception of an uplink assignment message the mobile station shall stop timer T3168 for each TBF assigned in the message.

The mobile station shall, after expiry of the TBF starting time, if present, act upon the uplink assignment.

The mobile station shall then switch to the assigned uplink SBPSCHs and begin to send RLC data blocks on the assigned SBPSCH(s). The G-RNTI shall not be included in any of the uplink RLC data blocks.

On receipt of a PACKET ACCESS REJECT message that contains a Reject structure addressed to the mobile station, the mobile station shall stop timer T3168 for each TBF rejected in the PACKET ACCESS REJECT message and indicate a packet access failure to the upper layer.

If the PACKET ACCESS REJECT message contains a WAIT_INDICATION field in a Reject structure addressed to the mobile station, the mobile station shall start timer T3172 for each TBF rejected with the indicated value (Wait Indication). The mobile station is not allowed to make a new attempt for an uplink TBF establishment in the same cell until all instances of timer T3172 expire, but it may attempt uplink TBF establishment in another cell after successful cell reselection.

If timer T3168 expires for a TBF, the mobile station shall:

- if the mobile station has no existing uplink TBF:
- retransmit the Iu mode Channel Request Description information element in the next (EGPRS) PACKET DOWNLINK ACK/NACK message unless the Iu mode Channel Request Description has already been transmitted four times for that TBF in which case the mobile station shall perform an abnormal release with access retry (see sub-clause 8.8.3, 3GPP TS 44.060 sub-clause 8.7.2).
- if the mobile station has at least one uplink TBF:
 - proceed with uplink TBF establishment as defined in sub-clause 8.2.2.1.2.

If the downlink TBF is released, including expiry of timer T3192, before expiry of timer T3168, the mobile station shall stop timer T3168 for each TBF and perform an abnormal release with access retry (see sub-clause 8.8.3, 3GPP TS 44.060 sub-clause 8.7.2).

8.2.3.5.1 Abnormal cases

In the following abnormal cases it is assumed that at least one downlink TBF exists. The subsequent behaviour of the mobile station depends on the type of failure and previous actions.

- If the information in the PACKET UPLINK ASSIGNMENT or MULTIPLE TBF UPLINK ASSIGNMENT message incorrectly specifies one or more uplink PDCHs, the mobile station shall perform an abnormal release with access retry of the uplink TBF(s) with erroneous assignments (see sub-clause 8.8.5). The mobile station shall act upon the valid assignments.

- If the information in the PACKET TIMESLOT RECONFIGURE or MULTIPLE TBF TIMESLOT RECONFIGURE message incorrectly specifies one or more uplink and/or downlink PDCHs, the mobile station shall perform an abnormal release with access retry of the uplink TBF(s) with erroneous assignments (see sub-clause 8.8.5). The mobile station shall act upon the valid assignments.
- If the information in the PACKET UPLINK ASSIGNMENT, MULTIPLE TBF UPLINK ASSIGNMENT, PACKET TIMESLOT RECONFIGURE or MULTIPLE TBF TIMESLOT RECONFIGURE message violates the mobile station's multislot capabilities, the mobile station shall perform an abnormal release with access retry (see sub-clause 8.8.3).
- If the mobile station receives a PACKET UPLINK ASSIGNMENT or MULTIPLE TBF UPLINK ASSIGNMENT message containing different frequency parameters than are currently in effect for its existing TBFs, the mobile station shall ignore the PACKET UPLINK ASSIGNMENT or MULTIPLE TBF UPLINK ASSIGNMENT message, continue normal operation of the existing TBFs, and reinitiate the establishment of the new uplink TBFs unless the establishment of any of these TBFs has already been attempted four times, in which case, the mobile station shall perform an abnormal release with access retry (see sub-clause 8.8.3).
- If a mobile station in MAC-DTM state receives a PACKET UPLINK ASSIGNMENT or MULTIPLE TBF UPLINK ASSIGNMENT message including the Frequency Parameters information element, the mobile station shall perform an abnormal release with access retry (see sub-clause 8.8.3).
- If an uplink TBF is not already established and the PACKET TIMESLOT RECONFIGURE message does not include a UPLINK_TFI_ASSIGNMENT field, then the mobile station shall perform an abnormal release with access retry (sub-clause 8.8.3).
- If an uplink TBF is not already established and the MULTIPLE TBF TIMESLOT RECONFIGURE message does not assign any uplink TBFs, then the mobile station shall perform an abnormal release with access retry (sub-clause 8.8.3).
- If the mobile station receives a PACKET UPLINK ASSIGNMENT, MULTIPLE TBF UPLINK ASSIGNMENT, PACKET TIMESLOT RECONFIGURE or MULTIPLE TBF TIMESLOT RECONFIGURE message contains assignments such that more than one radio bearer is mapped onto a TBF, then the mobile station shall perform an abnormal release with access retry (see sub-clause 8.8.3).
- If the MULTIPLE TBF UPLINK ASSIGNMENT or MULTIPLE TBF TIMESLOT RECONFIGURE message does not specify a Channel Coding scheme for all of the uplink TBFs that it is assigning, then the mobile station shall perform an abnormal release with access retry of the uplink TBFs with erroneous assignments (see sub-clause 8.8.5). The mobile station shall act upon the valid assignments.
- If the PACKET UPLINK ASSIGNMENT, MULTIPLE TBF UPLINK ASSIGNMENT, MULTIPLE TBF TIMESLOT RECONFIGURE message assigns the same USF to more than one TBF on the same timeslot, then the mobile station shall perform an abnormal release with access retry (sub-clause 8.8.3).
- If the PACKET UPLINK ASSIGNMENT, MULTIPLE TBF UPLINK ASSIGNMENT, PACKET TIMESLOT RECONFIGURE, MULTIPLE TBF TIMESLOT RECONFIGURE message specifies a RB Id that is not assigned to the mobile station, then the mobile station shall perform an abnormal release with access retry (sub-clause 8.8.3).
- If the PACKET ACCESS REJECT message does not specify a G-RNTI_extension field in the Iu mode Reject structure for each G-RNTI included in the TLLI / G-RNTI field in the Reject structure, then the mobile station shall ignore the message.
- If the PACKET ACCESS REJECT message includes one or more RB Id fields in the Iu mode Reject structure which were not included by the mobile station in the Iu mode Channel Request Description structure, then the mobile station shall perform abnormal release with access retry (see sub-clause 8.8.3).- If a mobile station in MAC-DTM state receives a PACKET TIMESLOT RECONFIGURE or MULTIPLE TBF TIMESLOT RECONFIGURE message including the Frequency Parameters information element, the mobile station shall perform an abnormal release with access retry (see sub-clause 8.8.3).
- If a failure in the PACKET UPLINK ASSIGNMENT, MULTIPLE TBF UPLINK ASSIGNMENT, PACKET TIMESLOT RECONFIGURE or MULTIPLE TBF TIMESLOT RECONFIGURE message is due to any other reason, the mobile station shall perform an abnormal release with access retry (see sub-clause 8.8.3).

8.2.3.6 Network initiated abnormal release of downlink TBF

See 3GPP TS 44.060 sub-clause 8.1.2.8.

8.3 Packet PDCH Release

See 3GPP TS 44.060 sub-clause 8.2.

8.4 Procedure for measurement report sending in MAC-Shared state

See 3GPP TS 44.060 sub-clause 8.3.

8.5 Network Controlled cell reselection procedures in MAC-Shared state

See 3GPP TS 44.060 sub-clause 8.4.

8.6 Measurement Order procedures in MAC-Shared state

See 3GPP TS 44.060 sub-clause 8.5.

8.7 PACKET CONTROL ACKNOWLEDGEMENT

See 3GPP TS 44.060 sub-clause 8.6.

8.8 Abnormal cases

8.8.1 General

See 3GPP TS 44.060 sub-clause 8.7.0.

8.8.2 Abnormal release without retry

See 3GPP TS 44.060 sub-clause 8.7.1.

8.8.3 Abnormal release with access retry

The mobile station shall abort all TBFs in progress. The mobile station in MAC-Shared state shall return to MAC-Idle state and initiate the establishment of a new uplink TBF on SBPSCH(s), using the procedures on PCCCH, as defined in sub-clause 7.2.

The mobile station in MAC-DTM state shall return to MAC-Dedicated state and initiate the establishment of a new uplink TBF on SBPSCH(s) using DTM procedures on SRB2, as defined in 3GPP TS 44.118.

In case the mobile station fails to establish a new uplink TBF on SBPSCH(s), the mobile station shall report an RLC/MAC failure to upper layers. The DRX mode procedures shall be applied, as specified in sub-clause 5.4.1.8.

8.8.4 Abnormal release with system information

See 3GPP TS 44.060 sub-clause 8.7.3.

8.8.5 Abnormal release of an Uplink TBF with access retry

The mobile station shall abort the uplink TBF.

If there are no remaining TBFs on SBPSCHs and the mobile station was in MAC-Shared state, then it shall return to MAC-Idle state and reinitiate the establishment of the uplink TBF on SBPSCH(s) using the procedures on PCCCH, as defined in sub-clause 7.2. In the case that this TBF was not the last remaining TBF on SBPSCHs, the mobile station shall reinitiate the establishment of the TBF on SBPSCHs, using the procedures defined on PACCH, as defined in sub-clauses 8.2.3 and 8.3.3.

If there are no remaining TBFs on SBPSCHs and the mobile station was in MAC-DTM state, then it shall return to MAC-Dedicated state and initiate the establishment of the uplink TBF on SBPSCH(s) using DTM procedures on SRB2, as defined in 3GPP TS 44.118. In the case that this TBF was not the last remaining TBF on SBPSCHs, the mobile station shall initiate the establishment of the TBF on SBPSCHs, using the procedures defined on PACCH, as defined in sub-clauses 8.2.3 and 8.3.3.

In case the mobile station fails to establish the new uplink TBF on SBPSCH(s), the mobile station shall report an RLC/MAC failure to upper layers. The DRX mode procedures shall be applied, as specified in sub-clause 5.4.1.8.

8.8.6 Abnormal release of a Downlink TBF

The mobile station shall abort the downlink TBF.

If there are no remaining TBFs on SBPSCHs and the mobile station was in MAC-Shared state, then it shall return to MAC-Idle state.

If there are no remaining TBFs on SBPSCHs and the mobile station in MAC-DTM state, then it shall return to MAC-Dedicated state.

If there is a TBF remaining on SBPSCHs, then the mobile station shall remain in its current state.

The DRX mode procedures shall be applied as specified in sub-clause 5.5.1.5, 3GPP TS 44.160 sub-clause 5.4.1.8.

8.9 Network Assisted Cell Change procedures in MAC-Shared state

See 3GPP TS 44.060 sub-clause 8.8.

9 Medium Access Control (MAC) procedures on DBPSCH

9.1 General

The MAC procedures defined in this sub-clause are applicable in MAC-Dedicated state and in MAC-DTM state on DBPSCH only. When a radio bearer is set-up on DBPSCH(s) (see 3GPP TS 44.118) the corresponding TBF is implicitly established, on this DBPSCH(s), on the logical channel on which this TBF is mapped. This TBF shall use the TBF mode as specified in sub-clause 5.2.2.2 and according to the radio bearer attributes as may be indicated in the CMAC-CONFIG primitive received from RRC.

9.2 Transfer of RLC/MAC blocks

9.2.0 General

Tables 9.2.0.1 to 9.2.0.3 summarise the RLC/MAC control messages that may be sent on a logical channel that is mapped onto a DBPSCH.

Table 9.2.0.1: RLC/MAC control messages on PACCH when mapped on DBPSCH

RLC messages:	Reference
Packet Downlink Ack/Nack	3GPP TS 44.060 sub-clause 11.2.6
EGPRS Packet Downlink Ack/Nack	3GPP TS 44.060 sub-clause 11.2.6a
Packet Uplink Ack/Nack	3GPP TS 44.060 sub-clause 11.2.28
Miscellaneous messages:	Reference
Packet Control Acknowledgement	3GPP TS 44.060 sub-clause 11.2.2
Packet Downlink Dummy Control Block	3GPP TS 44.060 sub-clause 11.2.8
Packet Uplink Dummy Control Block	3GPP TS 44.060 sub-clause 11.2.8b
Packet Mobile TBF Status	3GPP TS 44.060 sub-clause 11.2.9c
Packet Polling Request	3GPP TS 44.060 sub-clause 11.2.12
Packet Uplink Assignment	3GPP TS 44.060 sub-clause 11.2.29
Handover Access	3GPP TS 44.060 sub-clause 11.2.33
Physical Information	3GPP TS 44.060 sub-clause 11.2.34

Table 9.2.0.2: RLC/MAC control messages on SDCCH, SACCH, FACCH (PT="01")

RLC messages:	Reference
Packet DBPSCH Downlink Ack/Nack	3GPP TS 44.060 sub-clause 11.2.6b
Packet DBPSCH Uplink Ack/Nack	3GPP TS 44.060 sub-clause 11.2.28a
Miscellaneous messages:	Reference
Packet Control Acknowledgement	3GPP TS 44.060 sub-clause 11.2.2
Packet Downlink Dummy Control Block	3GPP TS 44.060 sub-clause 11.2.8
Packet Uplink Dummy Control Block	3GPP TS 44.060 sub-clause 11.2.8b
Packet Mobile TBF Status	3GPP TS 44.060 sub-clause 11.2.9c
Handover Access	3GPP TS 44.060 sub-clause 11.2.33
Physical Information (not on SACCH)	3GPP TS 44.060 sub-clause 11.2.34

Table 9.2.0.3: RLC/MAC control messages on FACCH (PT="10")

RLC messages:	Reference
Packet DBPSCH Downlink Ack/Nack	3GPP TS 44.060 sub-clause 11.2.6b
Packet DBPSCH Uplink Ack/Nack	3GPP TS 44.060 sub-clause 11.2.28a
Miscellaneous messages:	Reference
Packet Control Acknowledgement	3GPP TS 44.060 sub-clause 11.2.2
Packet Mobile TBF Status	3GPP TS 44.060 sub-clause 11.2.9c

9.2.1 Dedicated allocation

9.2.1.1 General

On DBPSCH, the transfer of RLC/MAC blocks is governed by the principles of the dedicated allocation. Dedicated allocation is applicable to GPRS TBF mode, EGPRS TBF mode, TCH TBF mode and DCCH TBF mode. No other medium access mode shall apply for TCH TBF mode and DCCH TBF mode.

A mobile station in dedicated allocation shall monitor the assigned DBPSCH(s). The mobile station shall attempt to decode every downlink RLC/MAC block on the assigned DBPSCH(s). Whenever the mobile station receives an RLC/MAC block containing an RLC/MAC control block, the mobile station shall attempt to interpret the message contained therein and act upon it.

Except for TCH TBF mode in T-RLC mode, PACKET UPLINK DUMMY CONTROL block(s) (respectively PACKET DOWNLINK DUMMY CONTROL block(s)) shall be sent in periods when no RLC/MAC block is scheduled for transmission in uplink direction (respectively downlink direction, following the scheduling requirements defined in 3GPP TS 45.008). For TCH TBF mode in T-RLC mode, DTX may apply.

9.2.1.2 Performance requirements for TCH and DCCH TBF modes

When the mobile station receives a DBPSCH assignment, the mobile station shall switch to the assigned DBPSCH(s) and be ready to transmit within the reaction time defined in 3GPP TS 45.010.

The network (NW) and the mobile station (MS) shall follow the performance requirements defined in the table below. These performance requirements are given on a logical channel and MAC state basis, and define the response time of the network and the mobile station upon receipt of a request from the remote peer entity, where:

- Trmin and Tresp denote respectively the minimum and maximum response times following the reception of a given request, expressed in TDMA frames, as follows:
 - if a polling request is received whose last burst has been physically transmitted in the TDMA frame number FNcomm, then the first burst carrying a segment of the corresponding response shall be physically transmitted in the TDMA frame number FNresp where:

$$FNcomm + Trmin + 1 \leq FNresp \leq FNcomm + Tresp + 1$$

- following the mapping of logical channels onto physical channels and the arithmetics on TDMA frame numbers specified in 3GPP TS 45.002.

Table 9.2.1.2.1: Response time

Request sent on	Response sent on	Trmin	Tresp (see note 1)	
			MAC-Dedicated state	MAC-DTM state
SDCCH	SDCCH	MS: 11 NW: TRMIN_SDCCH (32 or 83)	MS: 113 NW: TRESP_SDCCH (134 or 185, respectively)	Not applicable
SACCH	SACCH	MS: 11 NW: 83	MS: 11 NW: 83	
SACCH (with a TCH or PDTCH)	SACCH (with a TCH or PDTCH)	MS: 25 NW: TRMIN_SACCH (25 or 129)	MS: 129 NW: TRESP_SACCH (129 or 233, respectively)	MS: 25 NW: TRMIN_SACCH
FACCH/Full rate	FACCH/Full rate	MS: 9 NW: TRMIN	MS: 18 (max between 18 and 17) NW: TRESP_MAC_Dedicated	MS: 14 (max between 13 and 14) NW: TRESP_MAC_DTM
TCH/Full rate	FACCH/Full rate	MS: 9 NW: TRMIN	MS: 18 (max between 18 and 17) NW: TRESP_MAC_Dedicated	MS: 14 (max between 13 and 14) NW: TRESP_MAC_DTM
FACCH/Half rate	FACCH/Half rate	MS: 10 NW: TRMIN	MS: 28 (max between 28 and 27) NW: TRESP_MAC_Dedicated	MS: 19 (max between 18 and 19) NW: TRESP_MAC_DTM
NOTE 1: these values account for the maximum amount of Radio Bearers multiplexed on a given logical channel, and the priorities of associated RLC/MAC blocks. For FACCH, it also accounts for the RLC/MAC control signalling related to the traffic on the TCH.				
NOTE 2: The combination TCH/H – FACCH/H is not supported.				
NOTE 3: "max between n and m" is to account for the shift of the start of the FACCH block where the response is sent, that occurs depending on the end of the TCH/FACCH block where the request was sent. (due to a different number of idle/SACCH frames included in the counts).				

9.2.2 Transfer of RLC/MAC blocks on TCH

One and only one TBF in TCH TBF mode may be mapped onto a TCH.

No RLC/MAC control blocks shall be sent on TCH. RLC/MAC control blocks belonging to a TBF in TCH TBF mode operating in NT-RLC mode shall be sent on FACCH with Payload Type (PT) = "10". No RLC/MAC control block shall be sent on FACCH if the corresponding TCH is occupied by a TBF operating in T-RLC mode unless this RLC/MAC control block belongs to a TBF in DCCH TBF mode mapped on this FACCH or carries a PHYSICAL INFORMATION

message. The HANOVER ACCESS message shall be sent on FACCH irrespective of the TBF mapped on TCH, following the rules defined in sub-clause 9.2.3.

An RLC/MAC control block carrying a PHYSICAL INFORMATION message on FACCH shall be sent with Payload Type (PT) = "01".

RLC/MAC blocks shall be transmitted with the following priority (highest priority first):

- RLC/MAC blocks on FACCH, except Packet Uplink/Downlink Dummy Control Blocks;
- RLC data blocks on TCH;
- RLC/MAC control blocks on FACCH containing Packet Uplink/Downlink Dummy Control Blocks.

9.2.3 Transfer of RLC/MAC blocks on FACCH, SACCH and SDCCH

A TBF associated with a URB may operate in DCCH TBF mode but shall not be mapped on SACCH.

On SACCH, MAC shall ensure the following as long as there is data to send for SRB1, and SRB3 and/or SRB4:

- every second RLC/MAC block sent on SACCH shall belong to SRB1, and the other to SRB3 or SRB4, and
- every second RLC/MAC block belonging to SRB1 shall be discarded, the other shall be sent on SACCH.

All RLC data blocks belonging to a TBF in DCCH TBF mode shall be encoded using CS-1.

The mobile station shall attempt to decode every downlink RLC/MAC block on FACCH, SACCH or SDCCH. Whenever the mobile station receives an RLC/MAC block containing an RLC/MAC control block, the mobile station shall attempt to interpret the message contained therein, and shall act on it.

Each RLC data block sent on FACCH, SACCH or SDCCH shall contain a Reduced Radio Bearer identity (RRBid) field corresponding to the radio bearer to which the RLC data block belongs.

On SDCCH, all the RLC data blocks of an uplink TBF shall each contain a G-RNTI field in the RLC data block header until contention resolution is completed on the mobile station side (see sub-clause 7.2.3.3.2.3). After the reaction time specified in 3GPP TS 45.010 no other RLC data blocks shall contain a G-RNTI field, except for those retransmitted RLC data blocks that originally contained a G-RNTI, which will be repeated including the same G-RNTI.

RLC/MAC blocks and HANOVER ACCESS message shall be transmitted with the following priority (highest priority first):

- HANOVER ACCESS message
- RLC/MAC control blocks with a Payload Type (PT) = "01" i.e. related to a TBF in DCCH TBF mode or carrying a PHYSICAL INFORMATION message, except Packet Uplink/Downlink Dummy Control blocks;
- RLC data blocks containing a piggy-backed acknowledgement;
- RLC/MAC control blocks with a Payload Type (PT) = "10" i.e. related to a TBF in TCH TBF mode, except Packet Uplink/Downlink Dummy Control blocks;
- RLC data blocks not containing a piggy-backed acknowledgement;
- RLC/MAC control blocks containing Packet Uplink/Downlink Dummy Control Blocks.

9.2.4 Transfer of RLC/MAC blocks on PDTCH and PACCH

9.2.4.1 General

9.2.4.1.1 Downlink transfer

9.2.4.1.1.1 General

RLC/MAC blocks shall be transmitted in the downlink with the following priority (highest priority first):

- RLC/MAC control blocks except Packet Downlink Dummy Control blocks;
- RLC data blocks;
- RLC/MAC control blocks containing Packet Downlink Dummy Control Blocks.

If the network has no other RLC/MAC block to transmit, but wishes to transmit on the downlink (e.g. to provide USF), the network shall transmit an RLC/MAC control block containing a Packet Downlink Dummy Control block.

9.2.4.1.1.2 Polling for Packet Downlink Ack/Nack

Whenever the mobile station receives an RLC data block addressed to (one of) its TBF(s) with a valid RRBP field in the RLC data block header (i.e. is polled), the mobile station may transmit a (EGPRS) PACKET DOWNLINK ACK/NACK message in the uplink radio block specified by the RRBP field whatever the BSN value of the received RLC data block, unless another RLC/MAC control message is waiting to be transmitted, in which case the other RLC/MAC control message shall be sent. The mobile station shall transmit an RLC/MAC control message other than a (EGPRS) PACKET DOWNLINK ACK/NACK message at most every second time it is polled for that TBF. Furthermore the mobile station shall not transmit an RLC/MAC control message on this TBF other than a (EGPRS) PACKET DOWNLINK ACK/NACK message if the (EGPRS) PACKET DOWNLINK ACK/NACK message contains a Final Ack Indicator set to '1' and shall not start T3192. The mobile station shall not send a PACKET CONTROL ACKNOWLEDGEMENT message unless otherwise specified (see sub-clause 9.3). The mobile station shall not send the lu mode channel request description field in the (EGPRS) PACKET DOWNLINK ACK/NACK message.

In EGPRS TBF mode the mobile station shall react on a poll inside an erroneously received RLC data block for which the header is correctly received.

Whenever the network receives a valid RLC/MAC control message from the TBF, it shall reset counter N3105. The network shall increment counter N3105 for each radio block allocated to that TBF with the RRBP field, for which no RLC/MAC control message is received. If $N3105 = N3105_{max}$, the network shall start timer T3195. When T3195 expires, the network shall notify a link failure to the RRC layer.

The PACKET DOWNLINK ACK/NACK message contains a Channel Quality Report (see 3GPP TS 45.008). The optional I_LEVEL measurement results shall be included in at least every other PACKET DOWNLINK ACK/NACK message.

The EGPRS PACKET DOWNLINK ACK/NACK message may contain an EGPRS Channel Quality Report (see 3GPP TS 45.008).

In the case of simultaneous uplink and downlink TBFs, the transmission of the polling response takes precedence over the transmission of allocated uplink radio blocks.

A mobile station of multislot class 1 to 12 need not respond to the poll if it is not compliant with the mobile station's multislot class (see 3GPP TS 45.002).

A mobile station of multislot class 13 to 18 shall always respond to the poll.

9.2.4.1.2 Uplink transfer

9.2.4.1.2.1 General

RLC/MAC blocks and HANDOVER ACCESS message shall be transmitted with the following priority (highest priority first):

- HANDOVER ACCESS message
- RLC/MAC control blocks except Packet Uplink Dummy Control blocks;
- RLC data blocks;
- RLC/MAC control blocks containing Packet Uplink Dummy Control Blocks.

Uplink TBFs are scheduled with USF. USF is assigned as described in sub-clause 9.2.4.1.2.2.

Whenever the mobile station detects an assigned USF value on an assigned DBPSCH, the mobile station shall transmit either a single RLC/MAC block or a sequence of four RLC/MAC blocks on the same DBPSCH and, in case there are

more DBPSCHs assigned in uplink than in downlink, also on all higher numbered assigned DBPSCHs. The time relation between an uplink block, which the mobile station shall use for transmission, and the occurrence of the USF value is defined in 3GPP TS 45.002. The number of RLC/MAC blocks to transmit is controlled by the USF_GRANULARITY parameter characterising the uplink TBF.

When the mobile station transmits an RLC/MAC block to the network, it shall start timer T3180 for the uplink TBF on which the block was sent. When the mobile station detects an assigned USF value on an assigned DBPSCH for the TBF, the mobile station shall restart timer T3180. If timer T3180 expires, the mobile station shall notify a link failure to the RRC layer.

Whenever the network receives a valid RLC/MAC block from the TBF, it shall reset counter N3101. The network shall increment counter N3101 for each radio block, allocated to that TBF, for which no data is received. If $N3101 = N3101_{max}$, the network shall stop the scheduling of RLC/MAC blocks from the TBF and start timer T3169. When T3169 expires, the network shall notify a link failure to the RRC layer.

The mobile station shall attempt to decode every downlink RLC/MAC block on all assigned DBPSCHs. Whenever the mobile station receives an RLC/MAC block containing an RLC/MAC control block, the mobile station shall attempt to interpret the message contained therein and act on the message.

Whenever the mobile station detects an assigned USF value on any assigned DBPSCH, the mobile station may transmit a PACCH block on the same DBPSCH in the next block period (see 3GPP TS 45.002). The mobile station shall not transmit an RLC data block in any uplink radio block allocated via the polling mechanism (see 3GPP TS 44.060 sub-clause 10.4.4).

In case there are more DBPSCHs assigned in uplink than in downlink, the network shall transmit all PACCH messages on the DBPSCH carried on the lowest numbered timeslot in the allocation.

9.2.4.1.2.2 On receipt of a Packet Uplink Assignment message

The USF of a TBF belonging to a URB is initially assigned by RRC using radio bearer control procedures (see 3GPP TS 44.118). The USF of a TBF belonging to a SRB is assigned by RLC/MAC.

The network may send a PACKET UPLINK ASSIGNMENT message to the mobile station on the PACCH on DBPSCH addressing a particular TBF on DBPSCH (identified in the Global_TFI field) in order to:

- assign a USF to this TBF only in case this TBF does not already have any assigned USF and/or to
- change one or more of the following parameters of this TBF: (EGPRS) channel coding command field, resegment bit, BEP_PERIOD2 field. All other parameters may only be changed through radio bearer control procedures (see 3GPP TS 44.118)

The network shall include a valid RRBP field in the RLC/MAC control block header and clear counter N3105.

In case the mobile station receives a PACKET UPLINK ASSIGNMENT message on PACCH (DBPSCH) addressing a particular uplink TBF on DBPSCH (identified in the Global_TFI field), the mobile station shall only act on the following fields:

- USF granularity and USF value per timeslot fields in the message (see 3GPP TS 44.060) if the mobile station does not already have a USF assigned to this TBF,
- starting time (if included),
- (EGPRS) Channel coding command,
- Resegment bit (if included), and
- BEP_PERIOD2 field (if included) and ignore other fields.

When the mobile station receives an uplink assignment that does not contain a TBF starting time, the mobile station shall begin to use the newly assigned parameters immediately for this TBF. If a TBF starting time information element is present the mobile station shall wait until the starting time before beginning to use these parameters for this TBF. If while waiting for the frame number indicated by the TBF starting time the mobile station receives another uplink assignment for the same TBF, the mobile station shall act upon the most recently received uplink assignment and shall ignore the previous uplink assignment.

When the mobile station receives the PACKET UPLINK ASSIGNMENT message, it shall transmit the PACKET CONTROL ACKNOWLEDGEMENT message in the radio block indicated by the RRBp field.

If the network does not receive the PACKET CONTROL ACKNOWLEDGEMENT message in the radio block indicated by the RRBp field, it shall increment counter N3105 and retransmit the PACKET UPLINK ASSIGNMENT message. If counter N3105 exceeds its limit, the network shall stop scheduling new uplink resources for the TBF, stop sending the PACKET UPLINK ASSIGNMENT message to the mobile station and start timer T3195.

When timer T3195 expires the network shall notify a link failure to the RRC layer.

9.2.4.1.2.3 Release of the USF

The network may initiate the release of the USF of a particular TBF by sending a PACKET UPLINK ACK/NACK message with the Final Ack Indicator set to '1'. The network shall include a valid RRBp field in the RLC/MAC control block header and clear counter N3103. The release of the USF, using this procedure, may be initiated at a point determined by the network.

If the mobile station receives a PACKET UPLINK ACK/NACK message with the Final Ack Indicator bit set to '1', it shall transmit a PACKET CONTROL ACKNOWLEDGEMENT message in the radio block indicated by the RRBp field and release the USF.

When the network receives the PACKET CONTROL ACKNOWLEDGEMENT message in the radio block indicated by the RRBp field, it may reuse the USF resource.

If the network does not receive the PACKET CONTROL ACKNOWLEDGEMENT message in the radio block indicated by the RRBp field, it shall increment counter N3103 and retransmit the PACKET UPLINK ACK/NACK message. If counter N3103 exceeds its limit, the network shall stop scheduling new uplink resources for the TBF, stop sending the PACKET UPLINK ACK/NACK message to the mobile station and start timer T3169.

When timer T3169 expires the network shall notify a link failure to the RRC layer.

9.2.4.2 Scheduling an inactive TBF on a DBPSCH

When a previously inactive TBF (i.e. for which the latest transmitted CV was equal to 0 and for which no USF is assigned) has data to send, the mobile station shall send one RLC data block for this TBF the next time the network schedules any of the mobile station's TBFs using the assigned USFs. This TBF shall be considered inactive until a USF is assigned to it. This RLC data block shall not be sent in a block that has been reserved for sending a RLC/MAC control message via the RRBp field. On sending a RLC data block on a radio block that has been stolen by this mechanism, the mobile station start timer T3194 for the associated radio bearer. The mobile station shall stop timer T3194 on receipt of the USF for this radio bearer (see sub-clause 9.2.4.1.2.2). The mobile station shall be able to steal further blocks from any of its scheduled TBFs, provided that no more than one block is stolen for a particular radio bearer during an interval defined by the duration of timer T3194. On expiry of timer T3194 the mobile station shall restart the timer unless it has expired four times, in which case the mobile station shall notify a link failure to the RRC layer.

9.2.4.3 Further USF handling

If the mobile station has more than one active TBF with data to send, the mobile station shall send data for the TBF corresponding to the received USF, with the exception given in sub-clause 9.2.4.2. If the mobile station has no data to send for the scheduled TBF (i.e. no RLC data block or no RLC/MAC control message other than PACKET UPLINK DUMMY CONTROL BLOCK message), and if the MS has data to send for one or more other TBFs mapped onto the same DBPSCH, the mobile station may send data from one of these other TBFs.

If the mobile station has only one TBF with data to send, the mobile station shall ignore the USF and shall transmit data for this TBF.

9.3 PACKET CONTROL ACKNOWLEDGEMENT

Upon receipt by the mobile station of a polling request (see sub-clauses 12.7.4 and 12.9.3) within an RLC/MAC control message sent on a given logical channel, the mobile station shall send a corresponding PACKET CONTROL ACKNOWLEDGEMENT message within the next possible uplink occurrence on the same logical channel. The

PACKET CONTROL ACKNOWLEDGEMENT message shall be formatted using the normal burst format. The next possible uplink occurrence is defined following the rules below:

- If the RLC/MAC control message is received on PACCH with a valid RRBP field as part of this RLC/MAC control message, the mobile station shall transmit a PACKET CONTROL ACKNOWLEDGEMENT message in the uplink radio block specified (see 3GPP TS 44.060 sub-clause 10.4.5)
- Otherwise, the mobile station shall send the PACKET CONTROL ACKNOWLEDGEMENT message following the requirements defined in sub-clause 9.2.1.2, considering the PACKET CONTROL ACKNOWLEDGEMENT message has higher priority than any other RLC/MAC control messages, and any RLC data block. Upon reception by the network of a PACKET CONTROL ACKNOWLEDGEMENT message that does not target a specific RLC entity, within the requirements defined in sub-clause 9.2.1.2, the network shall reset counter N3105. If the network does not receive a PACKET CONTROL ACKNOWLEDGEMENT message before the response time specified in sub-clause 9.2.1.2, it shall increment counter N3105. If counter $N3105=N3105_{max}$, the network shall indicate a link failure to the RRC layer.

9.3a Handover Access and Physical Information

9.3a.1 Handover Access

During a handover, upon trigger from RRC through the HANDOVER-Req primitive, the mobile station shall send a HANDOVER ACCESS message containing the necessary handover reference value (see sub-clause 4.3.4) to the network on either FACCH, PACCH (on DBPSCH) or SDCCH. While the HANDOVER ACCESS message is being sent on FACCH, PACCH (on DBPSCH) or SDCCH, the mobile station may send additional HANDOVER ACCESS messages on SACCH. In this case, the HANDOVER ACCESS message may be sent on any TDMA frame block (Bn) belonging to the allocated SACCH (see 3GPP TS 45.002). The mobile station shall not send any HANDOVER ACCESS message on SACCH if no HANDOVER ACCESS message is being sent on FACCH, PACCH or SDCCH.

Upon reception of a HANDOVER ACCESS message by the network, the RRC shall be notified through the HANDOVER-Ind primitive (see sub-clause 4.3.4) and the network shall then proceed as specified in 3GPP TS 44.118.

In case of non-synchronized cells (see 3GPP TS 44.118), no other RLC/MAC block than those containing the HANDOVER ACCESS message shall be sent by the mobile station while the PHYSICAL INFORMATION message has not been received by this mobile station.

9.3a.2 Physical Information

During a handover, upon trigger from RRC layer through the PHYSICAL-INFO-Req primitive, the network shall send a PHYSICAL INFORMATION message containing the necessary timing advance value (see sub-clause 4.3.4) to the mobile station, on FACCH, PACCH (on DBPSCH) or SDCCH. The PHYSICAL INFORMATION message shall be ciphered if applicable i.e. if ciphering is started (see 3GPP TS 44.118).

Upon reception of a PHYSICAL INFORMATION message, the RRC shall be notified through the PHYSICAL-INFO-Ind primitive and the mobile station shall then proceed as specified in 3GPP TS 44.118.

9.4 Abnormal cases

- If the mobile station receives an RLC/MAC control message on a logical channel where this RLC/MAC control message is not allowed (see sub-clause 9.2.0), the mobile station shall ignore the message.
- If the mobile station receives an acknowledgement message (PACKET UPLINK ACK/NACK, PACKET DBPSCH UPLINK ACK/NACK) with missing mandatory fields, the mobile station shall notify the RRC layer, which shall in turn re-establish all RLC entities for the radio bearers currently established on the DBPSCH(s) and release the DBPSCH(s), as specified in 3GPP TS 44.118.
- If the mobile station receives an acknowledgement message (PACKET UPLINK ACK/NACK, PACKET DBPSCH UPLINK ACK/NACK) for a radio bearer that is either not established on the DBPSCH(s) or for which no data has been sent in the direction of the acknowledgement on the DBPSCH(s), the mobile station shall notify the RRC layer, which shall in turn re-establish all RLC entities for the radio bearers currently established on the DBPSCH(s) and release the DBPSCH(s), as specified in 3GPP TS 44.118.

10 Radio Link Control (RLC) procedures on PDTCH and PACCH

10.1 General

See 3GPP TS 44.060 sub-clause 9.0.

10.2 Procedures and parameters for peer-to-peer operation

10.2.1 Send state variable V(S)

See 3GPP TS 44.060 sub-clause 9.1.1.

10.2.2 Control send state variable V(CS)

See 3GPP TS 44.060 sub-clause 9.1.1a.

10.2.3 Acknowledge state variable V(A)

See 3GPP TS 44.060 sub-clause 9.1.2.

10.2.4 Acknowledge state array V(B)

See 3GPP TS 44.060 sub-clause 9.1.3.

10.2.5 Block sequence number BSN

See 3GPP TS 44.060 sub-clause 9.1.4.

10.2.6 Receive state variable V(R)

See 3GPP TS 44.060 sub-clause 9.1.5.

10.2.7 Receive window state variable V(Q)

See 3GPP TS 44.060 sub-clause 9.1.6.

10.2.8 Receive state array V(N)

See 3GPP TS 44.060 sub-clause 9.1.7.

10.2.9 Starting sequence number (SSN) and received block bitmap (RBB)

See 3GPP TS 44.060 sub-clause 9.1.8.

10.2.10 Window Size

See 3GPP TS 44.060 sub-clause 9.1.9.

10.2.10a RLC buffer

The mobile station shall support one RLC buffer per direction (uplink and downlink). The RLC buffer in a given direction represents the amount of physical memory the mobile station shall support in this direction for RLC PDUs from all RLC instances in the transmit (uplink) or receive (downlink) window(s). The RLC buffer is given as a number of RLC data blocks assuming the highest (modulation and) coding scheme supported by the mobile station in this direction. The RLC buffer shall be as follows:

- A mobile station supporting GPRS (not supporting EGPRS) shall support a RLC buffer of size 64 in both uplink and downlink directions
- A mobile station supporting EGPRS shall support RLC buffers as defined in the table below

Table 10.2.10a.1: RLC buffer in a given direction

RLC buffer (see note 2)	Maximum amount of timeslots the MS can support in this direction (see note 1)							
	1	2	3	4	5	6	7	8
	192	256	384	512	640	768	896	1024
NOTE 1: See 3GPP TS 45.002 for multislots classes								
NOTE 2: E.g. an EGPRS capable mobile station able to support up to 5 timeslots in downlink direction shall support a downlink RLC buffer that accommodates 640 RLC data blocks using MCS-9								

NOTE: The total amount of RLC window size obtained by adding the RLC window size of each of the RLC instances running in the mobile station in a given direction may be larger than the mobile station's RLC buffer in this direction.

10.2.11 Compression

See 3GPP TS 44.060 sub-clause 9.1.10.

10.2.12 Segmentation of upper layer PDUs into RLC data units

See 3GPP TS 44.060 sub-clause 9.1.11.

If so ordered by RRC for a given signalling radio bearer using RLC acknowledged mode, in order to assure duplication avoidance at higher layer, RLC shall guarantee that no more than three upper layer PDUs shall be outstanding in the transmit window at any given time: there may be at most three upper layer PDUs that are being transmitted i.e. that have been segmented and for which the RLC PDUs are being transferred to the receiving end.

If so ordered by RRC (CRLC-CONFIG-Req primitive), the RLC transmitter may discard:

- in RLC acknowledged mode, RLC SDU(s) not yet segmented into RLC PDUs. The RLC transmitter shall notify the higher layer of all discarded RLC SDUs, if indicated (RLC-AM-DATA-DiscardReq primitive).
- in RLC unacknowledged mode, RLC SDU(s).

10.2.13 Re-assembly of upper layer PDUs from RLC data units

See 3GPP TS 44.060 sub-clause 9.1.12.

10.2.14 Segmentation of RLC/MAC control messages into RLC/MAC control blocks

See 3GPP TS 44.060 sub-clause 9.1.12a.

10.2.15 Re-assembly of RLC/MAC control messages from RLC/MAC control blocks

RLC/MAC control blocks shall be collected at the receiver until all RLC/MAC control blocks comprising an RLC/MAC control message have been received.

In MAC-Idle state, the mobile station shall be capable of receiving eight RLC/MAC control messages in parallel. If the mobile station receives RLC/MAC control blocks containing part of a ninth RLC/MAC control message while it still has RLC/MAC control blocks for eight partially received RLC/MAC control messages, the mobile station shall discard the RLC/MAC control block of the oldest partially received message.

In MAC-Shared state, MAC-Dedicated state or MAC-DTM state, the mobile station shall be capable of receiving sixteen RLC/MAC control messages in parallel. If the mobile station receives RLC/MAC control blocks containing part of a seventeenth RLC/MAC control message while it still has RLC/MAC control blocks for sixteen partially received RLC/MAC control messages, the mobile station shall discard the RLC/MAC control block of the oldest partially received message.

The mobile station shall start an instance of timer T3200 following the receipt of an RLC/MAC control block whose RTI value does not correspond to the RTI value of a partially received RLC/MAC control message or if the RLC/MAC control blocks were received on different SBPSCHs (respectively DBPSCHs). In non-DRX mode the duration of timer T3200 shall be four BS_CV_MAX block periods. In DRX mode the duration of timer T3200 shall be four times the DRX period (see 3GPP TS 43.064).

On receipt of an RLC/MAC control block containing a segment of an RLC/MAC control message such that the mobile station now has the complete RLC/MAC control message, the mobile station shall stop the corresponding instance of timer T3200.

If the mobile station discards a partially received RLC/MAC control message while the corresponding instance of timer T3200 is running, the mobile station shall stop the corresponding instance of timer T3200.

On expiry of an instance of timer T3200, the mobile station shall discard and ignore all segments of the corresponding partially received RLC/MAC control message.

Upon successful change of SBPSCH (respectively DBPSCH) allocation, the mobile station shall discard all partially received RLC/MAC control messages on SBPSCH (respectively DBPSCH) and stop the corresponding instances of timer T3200.

The mobile station shall discard any control message segment that contains an unknown TFI.

10.3 Operation during RLC/MAC control message transfer

See 3GPP TS 44.060 sub-clause 9.2.

10.4 Operation during RLC data block transfer

10.4.1 General

See 3GPP TS 44.060 sub-clause 9.3.0.

10.4.2 Countdown procedure

See 3GPP TS 44.060 sub-clause 9.3.1.

The countdown value that is included in each uplink RLC data block by the mobile station shall correspond to the RLC instance to which the RLC data block belongs. In case SFACCH is used, a TBF shall have a countdown value for each of the RLC instances multiplexed onto the TBF.

10.4.3 Delayed release of downlink Temporary Block Flow

This procedure is applicable in MAC-Shared state and in MAC-DTM state, on SBPSCH only. See 3GPP TS 44.060 sub-clause 9.3.1a.

10.4.4 Extended uplink TBF mode

This procedure is applicable in MAC-Shared state and in MAC-DTM state, on SBPSCH only.

See 3GPP TS 44.060 sub-clause 9.3.1b.

10.4.5 Acknowledged mode operation

10.4.5.1 General

See 3GPP TS 44.060 sub-clause 9.3.2.0.

10.4.5.2 Additional functionality in acknowledged EGPRS TBF Mode

See 3GPP TS 44.060 sub-clause 9.3.2.1.

10.4.5.3 Establishment of Temporary Block Flow

The establishment of a TBF occurs as described in clause 7. RLC functions related to the ARQ function shall not operate until RLC data block transfer has been initiated.

If for a given radio bearer, the uplink TBF ended with an incompletely transmitted upper layer PDU or any unacknowledged upper layer PDUs, the mobile station shall begin transmission on the new TBF corresponding to this radio bearer with the oldest unacknowledged upper layer PDU.

10.4.5.4 Operation of uplink Temporary Block Flow

See 3GPP TS 44.060 sub-clause 9.3.2.3.

10.4.5.5 Release of uplink Temporary Block Flow

See 3GPP TS 44.060 sub-clause 9.3.2.4.

10.4.5.6 Operation of downlink Temporary Block Flow

See 3GPP TS 44.060 sub-clause 9.3.2.5.

10.4.5.7 Release of downlink Temporary Block Flow

See 3GPP TS 44.060 sub-clause 9.3.2.6.

10.4.6 Unacknowledged mode operation

10.4.6.1 General

See 3GPP TS 44.060 sub-clause 9.3.3.0.

10.4.6.2 Establishment of Temporary Block Flow

If for a given radio bearer, the uplink TBF ended with an incompletely transmitted upper layer PDU, the mobile station shall begin transmission on the new TBF corresponding to this radio bearer with the last incompletely transmitted upper layer PDU.

10.4.6.3 Operation of uplink Temporary Block Flow

See 3GPP TS 44.060 sub-clause 9.3.3.2.

10.4.6.4 Release of uplink Temporary Block Flow

See 3GPP TS 44.060 sub-clause 9.3.3.3.

10.4.6.5 Operation of downlink Temporary Block Flow

See 3GPP TS 44.060 sub-clause 9.3.3.4.

10.4.6.6 Release of downlink Temporary Block Flow

See 3GPP TS 44.060 sub-clause 9.3.3.5.

10.5 Abnormal release cases

10.5.1 Abnormal release with access retry

Abnormal release with access retry is described in sub-clause 8.8.3. It is applicable in MAC-Shared state and in MAC-DTM state, on SBPSCH only.

10.5.2 Abnormal release with cell reselection

Abnormal release with cell reselection is applicable in MAC-Shared state only.

See 3GPP TS 44.060 sub-clause 9.4.2.

10.6 Uplink TBF release in extended uplink TBF mode

This procedure is applicable in MAC-Shared state and in MAC-DTM state, on SBPSCH only.

In the extended uplink TBF mode (see sub-clause 10.4.4), the network may initiate the release an uplink TBF by sending a PACKET UPLINK ACK/NACK message with the Final Ack Indicator set to '1'. The network shall include a valid RRBP field in the RLC/MAC control block header and clear counter N3103. The network may use the TBF Est field in the PACKET UPLINK ACK/NACK message to allow the mobile station to request the establishment of new TBF. The release of the uplink TBF, using this procedure, may be initiated at a point determined by the network.

If the PACKET UPLINK ACK/NACK message has the Final Ack Indicator bit set to '1' and the following conditions are fulfilled: TBF Est field is set to '1'; the mobile station has new data to transmit; the mobile station has no ongoing downlink TBF, the mobile station shall release the TBF and may request the establishment of new TBF using one of the following procedures:

- If Control Ack Type parameter in System Information indicates acknowledgement is access burst, the mobile station shall transmit the PACKET CONTROL ACKNOWLEDGEMENT message with the Ctrl Ack bits set to '00'. The mobile station shall start timer T3168 and continue to monitor the PDCH used for transmitting the PACKET CONTROL ACKNOWLEDGEMENT message. The mobile station shall stop timer T3168 upon reception of the PACKET UPLINK ASSIGNMENT message including Single Block Allocation structure or the PACKET ACCESS REJECT message. The mobile station shall use the same procedures as are used for TBF establishment using two phase access described in sub-clause 7.2.4 starting from the point where the mobile station receives the PACKET UPLINK ASSIGNMENT message including Single Block Allocation structure or the PACKET ACCESS REJECT message.
- If Control Ack Type parameter in System Information indicates acknowledgement is RLC/MAC control block, the mobile station shall transmit the PACKET RESOURCE REQUEST message and start timer T3168. The mobile station shall use the same procedures as are used for TBF establishment using two phase access described in sub-clause 7.2.4 starting from the point where the mobile station transmits the PACKET RESOURCE REQUEST message.

If the PACKET UPLINK ACK/NACK message has the Final Ack Indicator bit set to '1' and the mobile station does not initiate the establishment of a new uplink TBF according to one of the procedures described above, the mobile station shall transmit the PACKET CONTROL ACKNOWLEDGEMENT message and release the TBF. If there is no ongoing downlink TBF, the mobile station in MAC-Shared state shall return to respectively MAC-Idle state; the mobile station in MAC-DTM state shall return to MAC-Dedicated state. The DRX mode procedures shall be applied as specified in sub-clause 5.4.1.8.

When the network receives the PACKET CONTROL ACKNOWLEDGEMENT message or the PACKET RESOURCE REQUEST message in the radio block indicated by the RRBP field, it may reuse the TFI and USF resources.

If the network receives the PACKET CONTROL ACKNOWLEDGEMENT message with Ctrl Ack bits set to '00' or the PACKET RESOURCE REQUEST message in the radio block indicated by the RRBP field and the network has set the TBF Est field to '1' in the PACKET UPLINK ACK/NACK message, the network shall follow one of the following procedures:

- In case the mobile station requested the establishment of new TBF with the PACKET CONTROL ACKNOWLEDGEMENT message, the network shall respond to the mobile station with the PACKET UPLINK ASSIGNMENT message including Single Block Allocation structure or the PACKET ACCESS REJECT message on the same PDCH as the mobile station has sent the PACKET CONTROL ACKNOWLEDGEMENT message. The G-RNTI shall be used to identify the mobile station. The network shall use the same procedures as are used for TBF establishment using two phase access described in sub-clause 7.2.4 starting from the point where the network transmits the PACKET UPLINK ASSIGNMENT message including Single Block Allocation structure or the PACKET ACCESS REJECT message.
- In case the mobile station requested the establishment of new TBF with the PACKET RESOURCE REQUEST message, the network shall use the same procedures as are used for TBF establishment using two phase access described in sub-clause 7.2.4 starting from the point where the network has received the PACKET RESOURCE REQUEST message. The G-RNTI shall be used to identify the mobile station.

If the network does not receive the PACKET CONTROL ACKNOWLEDGEMENT message or the PACKET RESOURCE REQUEST message in the radio block indicated by the RRBP field, it shall increment counter N3103 and retransmit the PACKET UPLINK ACK/NACK message. If counter N3103 exceeds its limit, the network shall stop scheduling new uplink resources for the TBF, stop sending the PACKET UPLINK ACK/NACK message to the mobile station and start timer T3169.

When timer T3169 expires, the network may reuse the TFI and USF resources.

If for a given radio bearer the uplink TBF was operating in RLC acknowledged mode and there is an incompletely transmitted upper layer PDU or an upper layer PDU, which is not fully acknowledged, it shall be transmitted after establishing a new uplink TBF for this radio bearer.

11 Radio Link Control (RLC) procedures on TCH, FACCH, SACCH and SDCCH

11.1 General

This sub-clause describes the RLC procedures in TCH TBF mode and DCCH TBF mode applicable in MAC-Dedicated state and MAC-DTM state. Unless explicitly stated otherwise, the procedures and parameters in this sub-clause are not applicable in T-RLC mode.

In TCH TBF mode, the following definitions apply in NT-RLC mode only:

- Sequence Number Space (SNS): 256.
- Window Size (WS): 128.

In DCCH TBF mode, the following definitions apply:

- Sequence Number Space (SNS): 16.
- Window Size (WS): 8.

11.2 Procedures and parameters for peer-to-peer operation

11.2.1 Send state variable $V(S)$

See 3GPP TS 44.060 sub-clause 9.1.1.

11.2.2 Control send state variable $V(CS)$

See 3GPP TS 44.060 sub-clause 9.1.1a.

11.2.3 Acknowledge state variable $V(A)$

See 3GPP TS 44.060 sub-clause 9.1.2.

11.2.4 Acknowledge state array $V(B)$

In RLC acknowledged mode, each RLC endpoint transmitter shall have an associated acknowledge state array ($V(B)$). $V(B)$ is an array of SNS elements indicating the acknowledgement status of WS previous RLC data blocks. The array is indexed relative to the acknowledge state variable $V(A)$ modulo SNS. The values of $V(B)$ shall be updated from the latest values received from its peer in the received block bitmap (RBB) of either the piggy-backed acknowledgement (DCCH TBF mode only) or the Packet Ack/Nack message (DCCH TBF mode or TCH TBF mode) (see sub-clause 11.2.10).

The transmitter shall transmit the oldest RLC data block whose corresponding element in $V(B)$ indexed relative to $V(A)$ has the value NACKED. As each RLC data block is transmitted the corresponding element in $V(B)$ is set to the value PENDING_ACK.

If $[V(S) < V(A) + WS]$ modulo SNS and no RLC data blocks have a corresponding element in $V(B)$ with the value NACKED, the RLC data block with $BSN = V(S)$ shall be transmitted and the corresponding element in $V(B)$ shall be set to the value PENDING_ACK. If there are no further RLC data blocks available for transmission (i.e. the RLC data block with $BSN = V(S)$ does not exist), the sending side shall transmit the oldest RLC data block whose corresponding element in $V(B)$ has the value PENDING_ACK, then the next oldest block whose corresponding element in $V(B)$ has the value PENDING_ACK, etc. If all RLC data blocks whose corresponding element in $V(B)$ has the value PENDING_ACK have been transmitted once, the process shall be repeated beginning with the oldest RLC data block.

If $V(S) = V(A) + WS$ modulo SNS (i.e. the transmit window is stalled), the sending side shall transmit the oldest RLC data block whose corresponding element in $V(B)$ has the value PENDING_ACK, then the next oldest RLC data block whose corresponding element in $V(B)$ has the value PENDING_ACK, etc. If all RLC data blocks whose corresponding element in $V(B)$ has the value PENDING_ACK have been transmitted once, the process shall be repeated beginning with the oldest RLC data block. This process of transmitting the oldest RLC data blocks whose value in $V(B)$ has the value PENDING_ACK shall continue, as long as equation $[V(S) = V(A) + WS]$ modulo SNS holds.

When an element in $V(B)$ falls outside of the active transmit window, i.e. $[V(A) \leq BSN < V(S)]$ modulo SNS, the element shall be set to the value INVALID.

If $V(S) = V(A)$ and there is no RLC data block with $BSN = V(S)$ available, the mobile station shall stop sending RLC data blocks. The mobile station shall continue sending RLC data blocks when a RLC data block with $BSN = V(S)$ is available.

11.2.5 Block sequence number BSN

11.2.5.1 Block sequence number for TCH TBF mode

Each RLC data block contains a block sequence number (BSN) field that is 8 bits in length. At the time that an in-sequence RLC data block is designated for transmission, the value of BSN is set equal to the value of the send state variable $V(S)$.

11.2.5.2 Block sequence number for DCCH TBF mode

Each RLC data block contains a block sequence number (BSN) field that is 4 bits in length. At the time that an in-sequence RLC data block is designated for transmission, the value of BSN is set equal to the value of the send state variable $V(S)$.

11.2.6 Reduced block sequence number RBSN

See 3GPP TS 44.060 sub-clause 9.1.4a.

11.2.7 Receive state variable $V(R)$

See 3GPP TS 44.060 sub-clause 9.1.5.

11.2.8 Receive window state variable $V(Q)$

See 3GPP TS 44.060 sub-clause 9.1.6.

11.2.9 Receive state array $V(N)$

See 3GPP TS 44.060 sub-clause 9.1.7.1.

11.2.10 Starting sequence number (SSN) and received block bitmap (RBB)

The Ack/Nack description IE contains a starting sequence number (SSN) and a received block bitmap (RBB). The Ack/Nack description IE is sent by the RLC receiver in a Packet Ack/Nack message (TCH TBF mode and DCCH TBF mode) or by piggy-backing within RLC data blocks (DCCH TBF mode) and is received by the RLC transmitter. The SSN and RBB are determined as defined in this sub-clause and transmitted in both RLC acknowledged and RLC unacknowledged mode. The SSN and RBB may be ignored by the RLC transmitter in unacknowledged mode.

The RBB is defined as a binary valued array of WS elements, where the index of each element takes value 0, 1, 2, ..., WS-1 in the given order, respectively. The BSN values specified in the RBB are interpreted by subtracting the bit position in the bitmap from the starting sequence number (SSN) modulo SNS.

A valid BSN value in the RBB is one that is in the range $[V(A) \leq BSN < V(S)]$ modulo SNS.

These inequalities shall be interpreted in the following way:

BSN is valid if, and only if, $[BSN - V(A)]$ modulo SNS $< [V(S) - V(A)]$ modulo SNS.

At the RLC transmitter:

- For each bit in the RBB whose corresponding BSN value is within the transmit window, if the bit contains the value '1', the corresponding element in $V(B)$ indexed relative to SSN shall be set to the value ACKED. If the bit contains the value '0', the element in $V(B)$ shall be set to the value NACKED. A bit within the RBB whose corresponding BSN is not within the transmit window, shall be ignored. If the bit contains the value '0', the last burst of the corresponding RLC data block has been physically transmitted in the TDMA frame number FNcomm, and the first burst carrying a segment of the PACKET DBPSCH UPLINK ACK/NACK or PACKET DBPSCH DOWNLINK ACK/NACK messages or of the piggy-backed acknowledgement has been physically transmitted in the TDMA frame number FNresp where $FNresp < FNcomm + Trmin + 1$ (i.e. the RLC data block was recently (re)transmitted and thus can not be validly negatively acknowledged in this particular acknowledgement), the element in $V(B)$ shall not be modified. See sub-clause 9.2.1.2 for the definition of Trmin.

At the RLC receiver:

- The starting sequence number (SSN) is assigned the value of the receive state variable $V(R)$. The received block bitmap (RBB) is assigned the WS elements whose indices, with incrementing order, correspond to elements in the receive state array $V(N)$ at the receiver whose indices, with decrementing order, range backwards from $[V(R) - 1]$ to $[V(R) - WS]$ (modulo SNS). For each bit in the bitmap, the bit is assigned the value '1' if the corresponding element in $V(N)$ indexed relative to SSN has the value RECEIVED. The bit is assigned the value '0' if the element in $V(N)$ has the value INVALID.
- When polled within a downlink RLC data block, the mobile station shall acknowledge all the RLC data blocks that have been correctly received up to and including the radio block where the mobile station is polled.
- As an implementation option, the mobile station may also acknowledge as many as possible of the RLC data blocks that are correctly received after the radio block where the mobile station is polled.

11.2.11 Window Size

11.2.11.1 TCH

For TCH TBF mode, the window size (WS) shall be 128.

11.2.11.2 FACCH, SACCH and SDCCH

For DCCH TBF mode, the window size (WS) shall be 8.

11.2.11a RLC buffer

See sub-clause 10.2.10b.

11.2.12 Segmentation of upper layer PDUs into RLC data units

See 3GPP TS 44.060 sub-clause 9.1.11.

Once an RLC data block has been transmitted over the physical link, should it be necessary to re-transmit the RLC data block, it shall be re-transmitted using the same channel coding scheme and BSN as it had in the previous transmission.

NOTE: The only coding scheme available in DCCH TBF mode is CS-1 coding.

If so ordered by RRC for a given signalling radio bearer using RLC acknowledged mode, in order to assure duplication avoidance at higher layer, RLC shall guarantee that no more than three upper layer PDUs shall be outstanding in the transmit window at any given time: there may be at most three upper layer PDUs that are being transmitted i.e. that have been segmented and for which the RLC PDUs are being transferred to the receiving end.

If so ordered by RRC (CRLC-CONFIG-Req primitive), the RLC transmitter may discard:

- in RLC acknowledged mode, RLC SDU(s) not yet segmented into RLC PDUs. The RLC transmitter shall notify the higher layer of all discarded RLC SDUs, if indicated (RLC-AM-DATA-DiscardReq primitive).
- in RLC unacknowledged mode, RLC SDU(s).

11.2.13 Re-assembly of upper layer PDUs from RLC data units

See 3GPP TS 44.060 sub-clause 9.1.12.

11.2.14 Segmentation of RLC/MAC control messages into RLC/MAC control blocks

See 3GPP TS 44.060 sub-clause 9.1.12a.

11.2.15 Re-assembly of RLC/MAC control messages from RLC/MAC control blocks

See 3GPP TS 44.160 sub-clause 10.2.15:

The duration of timer T3200 shall be so that, if the last burst of the RLC/MAC control block that triggered the start of timer T3200 has been physically transmitted in the TDMA frame number FNcomm, then the first burst carrying a segment of the RLC/MAC control block that triggered the stop of timer T3200 shall at the latest be physically transmitted in the TDMA frame number FNresp where:

$$\text{FNresp} = \text{FNcomm} + \text{Trmax} + 1, \text{ with Trmax defined as shown in the table below}$$

Table 11.2.15.1: Maximum difference between two segments of the same RLC/MAC control message

Logical channel	Trmax
SDCCH	Four TRMIN_SDCCH
SACCH	332
SACCH (with a TCH or PDTCH)	Four TRMIN_SACCH
FACCH/Full rate	Four TRMIN
FACCH/Half rate	Four TRMIN

11.3 Operation during RLC/MAC control message transfer

RLC/MAC control blocks shall be used to transport RLC/MAC control messages. Segments of only one RLC/MAC control message shall be transported per RLC/MAC control block.

RLC/MAC control blocks shall be sent at a higher priority than RLC data blocks.

The receiving side shall determine the length of the RLC/MAC control message contents by interpreting the RLC/MAC control block contents.

No general acknowledgement shall be made as part of the transfer of RLC/MAC control blocks or RLC/MAC control messages. The receiver shall not acknowledge an RLC/MAC control block except when it is polled by the transmitter as indicated by the polling (P) bit in the MAC header of this RLC/MAC control block. The receiver shall not acknowledge an RLC/MAC control message except when the RLC/MAC procedures explicitly specify an acknowledgement. Upon reception of a polling request, the receiver shall respond following the rules defined in sub-clause 9.2.3 and the requirements defined in sub-clause 9.2.1.2.

A RLC/MAC control block header, may contain a Radio Transaction Identifier (RTI) field that is 2 bits in length and performs in effect a modulo 4 count of the downlink RLC/MAC control messages sent on FACCH. The RTI field shall be used to group the RLC/MAC control blocks that make up an RLC/MAC control message. The RTI field allows the transmitting and receiving entities to distinguish between up to 4 RLC/MAC control messages in a single transmit direction therefore allowing up to 4 parallel transactions per FACCH.

The network shall not use the same RTI value at the same time on the same FACCH for two separate RLC/MAC control messages. The network shall transmit both segments of a segmented control message on the same FACCH.

11.4 Operation during RLC data block transfer

11.4.1 General

The RLC ARQ functions are applicable in NT-RLC mode only and support two modes of operation: RLC acknowledged mode and RLC unacknowledged mode. RLC acknowledged mode operation uses retransmission of RLC data blocks to achieve high reliability. RLC unacknowledged mode operation does not utilize retransmission of RLC data blocks. No ARQ function shall apply in T-RLC mode.

A TBF may operate in either RLC acknowledged mode, RLC unacknowledged mode or RLC transparent mode.

For a URB, the RLC mode of the corresponding TBF is set to either RLC acknowledged mode, RLC unacknowledged mode or RLC transparent mode at set-up of this particular URB by means of primitive exchange between RRC and RLC (CRLC-CONFIG) (see 3GPP TS 44.118).

For a SRB, the RLC mode of the corresponding TBF is set implicitly to the proper RLC mode, according to the identity of this particular SRB as follows:

- SRB1: RLC unacknowledged mode.
- SRB2, SRB3, SRB4: RLC acknowledged mode.

11.4.2 Acknowledged mode operation

11.4.2.1 General

The transfer of RLC data blocks in RLC acknowledged mode uses retransmissions of RLC data blocks. The transmitting side numbers the RLC data blocks via the block sequence number (BSN). The BSN is used for retransmission and for reassembly. The receiving side sends acknowledgement in order to request retransmission of RLC data blocks. The operation in RLC acknowledged mode shall be as described in sub-clause 11.2.

11.4.2.2 On TCH

11.4.2.2.1 General

In TCH TBF mode, the transfer of RLC data blocks in RLC acknowledged mode is controlled by a selective type I ARQ mechanism coupled with the numbering of the RLC data blocks.

11.4.2.2.2 Uplink

The selection of the proper channel coding scheme (E-TCH/F28.8, E-TCH/F32.0 and E-TCH/F43.2) is controlled by the network and ordered by RRC during radio bearer set-up and reconfiguration procedures (see 3GPP TS 44.118). The RLC/MAC block format used shall be the one corresponding to this channel coding scheme (see sub-clause 12.8).

The network shall send PACKET DBPSCH UPLINK ACK/NACK messages on FACCH when needed. The mobile station may poll the network for sending a PACKET DBPSCH UPLINK ACK/NACK message by setting the polling (P) bit in an uplink RLC data block. Upon reception by the network of a polling request, the network shall send a PACKET DBPSCH UPLINK ACK/NACK message for the corresponding RLC entity to the mobile station in the next possible downlink radio block on FACCH following the rules described in sub-clause 9.2.3 and the requirements defined in sub-clause 9.2.1.2. Upon reception by the mobile station of a PACKET DBPSCH UPLINK ACK/NACK message for this RLC entity, the mobile station shall reset counter N3106. If the mobile station does not receive any PACKET DBPSCH UPLINK ACK/NACK message for this RLC entity before the response time specified in sub-clause 9.2.1.2, the mobile station shall increment counter N3106. If counter $N3106 = N3106_{max}$, the mobile station shall indicate a link failure to the RRC layer which in turn shall stop the corresponding RLC entity (see sub-clause 14.3 and 3GPP TS 44.118).

The mobile station shall indicate a transmit window stall condition when $V(S) = V(A) + WS$. Upon detecting a transmit window stall condition the mobile station shall set the Stall Indicator (SI) bit in all subsequent uplink RLC data block until the stall condition ceases to exist.

Upon detecting the stall condition the mobile station shall also start timer T3182. Timer T3182 shall be stopped upon reception of a PACKET DBPSCH UPLINK ACK/NACK message that makes $V(S) < V(A) + WS$. If timer T3182 expires, the mobile station shall notify a link failure to the RRC layer which in turn shall stop the corresponding RLC entity (see sub-clause 14.3 and 3GPP TS 44.118).

11.4.2.2.3 Downlink

The mobile station receives RLC/MAC blocks for data transfer on TCH.

The selection of the proper channel coding scheme (E-TCH/F28.8, E-TCH/F32.0 and E-TCH/F43.2) is controlled by the network and ordered by RRC during radio bearer set-up and reconfiguration procedures (see 3GPP TS 44.118). The RLC/MAC block format used shall be the one corresponding to this channel coding scheme (see sub-clause 12.8). The

network may poll the mobile station for sending a PACKET DBPSCH DOWNLINK ACK/NACK message by setting the polling (P) bit in a downlink RLC data block. Upon reception by the mobile station of a polling request, the mobile station shall send a PACKET DBPSCH DOWNLINK ACK/NACK message to the network for the corresponding RLC entity in the next possible uplink radio block on FACCH following the rules described in sub-clause 9.2.3 and the requirements defined in sub-clause 9.2.1.2. Upon reception by the network of a PACKET DBPSCH DOWNLINK ACK/NACK message for this RLC entity, the network shall reset counter N3107. If the network does not receive any PACKET DBPSCH DOWNLINK ACK/NACK message for this RLC entity before the response time specified in sub-clause 9.2.1.2, the network shall increment counter N3107. If counter N3107=N3107max, the network shall indicate a link failure to the RRC layer which shall in turn stop the corresponding RLC entity (see sub-clause 14.3 and 3GPP TS 44.118).

11.4.2.3 On FACCH, SACCH or SDCCH

11.4.2.3.1 General

In DCCH TBF mode, the transfer of RLC Data Blocks in RLC acknowledged mode is controlled by a selective type I ARQ mechanism coupled with the numbering of the RLC data blocks.

11.4.2.3.2 Uplink

The mobile station shall transmit an RLC/MAC block in each assigned uplink radio block following the rules described in sub-clause 9.2.3. The network shall send acknowledgement when needed. The mobile station may poll the network for sending an acknowledgement by setting the polling (P) bit in an uplink RLC data block. Upon reception by the network of a polling request, the network shall send an acknowledgement (PACKET DBPSCH UPLINK ACK/NACK message or piggy-backed acknowledgement) to the mobile station for the corresponding RLC entity in the next possible downlink radio block following the rules defined in sub-clause 9.2.3 and the requirements defined in sub-clause 9.2.1.2. Piggy-backing of acknowledgement is possible following the rules below:

- If on the corresponding logical channel an RLC data block is scheduled for transmission in the next radio block:
 - if this RLC data block is an initial transmission, the acknowledgement shall be piggy-backed within this RLC data block;
 - if this RLC data block is a retransmission of an RLC data block wherein an acknowledgement was initially piggy-backed, the acknowledgement shall be piggy-backed within this retransmitted RLC data block.
- Otherwise a PACKET DBPSCH UPLINK ACK/NACK message shall be sent.

Upon reception by the mobile station of a acknowledgement for this RLC entity, the mobile station shall reset counter N3106. If the mobile station does not receive any acknowledgement for this RLC entity before the response time specified in sub-clause 9.2.1.2, the mobile station shall increment counter N3106. If N3106=N3106max, the mobile station shall indicate a link failure to the RRC layer which in turn shall stop the corresponding RLC entity (see sub-clause 14.3 and 3GPP TS 44.118).

The mobile station shall indicate a transmit window stall condition when $V(S) = V(A) + WS$. Upon detecting a transmit window stall condition, the mobile station shall set the Stall indicator (SI) bit in all subsequent uplink RLC data block until the stall condition ceases to exist.

Upon detecting the stall condition the mobile station shall also start timer T3182. Timer T3182 shall be stopped upon reception of a PACKET DBPSCH UPLINK ACK/NACK message that makes $V(S) < V(A) + WS$. If timer T3182 expires, the mobile station shall notify a link failure to the RRC layer which in turn shall stop the corresponding RLC entity (see sub-clause 14.3 and 3GPP TS 44.118).

11.4.2.3.3 Downlink

The mobile station shall be able to receive RLC/MAC blocks in RLC acknowledged mode on FACCH, SACCH and SDCCH. The mobile station shall, in the RLC/MAC header, identify the RRBid and decode the RLC data blocks belonging to the corresponding radio bearer.

The network may poll the mobile station for sending an acknowledgement by setting the polling (P) bit in a downlink RLC data block. Upon reception by the mobile station of a polling request, the mobile station shall send an acknowledgement (PACKET DBPSCH DOWNLINK ACK/NACK message or piggy-backed acknowledgement) for

the corresponding RLC entity to the network in the next possible uplink radio block following the rules defined in sub-clause 9.2.3 and the requirements defined in sub-clause 9.2.1.2. Piggy-backing of acknowledgement is possible following the rules below:

- If on the corresponding logical channel an RLC data block is scheduled for transmission in the next radio block:
 - if this RLC data block is an initial transmission, the acknowledgement shall be piggy-backed within this RLC data block.
 - if this RLC data block is a retransmission of an RLC data block wherein an acknowledgement was initially piggy-backed, the acknowledgement shall be piggy-backed within this retransmitted RLC data block.
- Otherwise a PACKET DBPSCH DOWNLINK ACK/NACK message shall be sent.

Upon reception by the network of an acknowledgement for this RLC entity, the network shall reset counter N3107. If the network does not receive any acknowledgement for this RLC entity before the response time specified in sub-clause 9.2.1.2, the network shall increment counter N3107. If counter $N3107=N3107_{max}$, the network shall indicate a link failure to the RRC layer which shall in turn stop the corresponding RLC entity (see sub-clause 14.3 and 3GPP TS 44.118).

11.4.3 Unacknowledged mode operation

11.4.3.1 General

The transfer of RLC data blocks in RLC unacknowledged mode does not include any retransmissions. The block sequence number (BSN) in the RLC data block header is used to number the RLC data blocks for reassembly. The operation in RLC unacknowledged mode shall be as described in sub-clause 11.2.

11.4.3.2 On TCH

11.4.3.2.1 Uplink

The network shall send acknowledgements when needed.

The mobile station shall set the Stall Indicator (SI) bit to "0" in all RLC data blocks.

If the mobile station transmits the number of RLC data blocks corresponding to the RLC window size (WS) (i.e. the mobile station's transmit window is stalled), the mobile station shall start timer T3182. Timer T3182 shall be stopped upon reception of a PACKET DBPSCH UPLINK ACK/NACK message targeting this RLC entity. If timer T3182 expires, the mobile station shall notify a link failure to the RRC layer which shall in turn stop the corresponding RLC entity.

11.4.3.2.2 Downlink

The network may poll the mobile station for sending a PACKET CONTROL ACKNOWLEDGEMENT message by setting the polling (P) bit in a downlink RLC data block in order to detect possible link failures. Upon reception by the mobile station of a polling request, the mobile station shall send a PACKET CONTROL ACKNOWLEDGEMENT message for the corresponding RLC entity to the network in the next possible uplink radio block following the rules defined in sub-clause 9.2.3 and the requirements defined in sub-clause 9.2.1.2. The PACKET CONTROL ACKNOWLEDGEMENT message shall be formatted using the normal burst format. Upon reception by the network of a PACKET CONTROL ACKNOWLEDGEMENT message for this RLC entity, the network shall reset counter N3107. If the network does not receive any PACKET CONTROL ACKNOWLEDGEMENT message for this RLC entity before the response time specified in sub-clause 9.2.1.2, the network shall increment counter N3107. If counter $N3107=N3107_{max}$, the network shall indicate a link failure to the RRC layer which shall in turn stop the corresponding RLC entity (see sub-clause 14.3 and 3GPP TS 44.118).

11.4.3.3 On FACCH, SACCH or SDCCH

11.4.3.3.1 Uplink

The network shall send acknowledgements when needed.

The mobile station shall set the Stall indicator (SI) bit to '0' in all RLC data blocks.

If the mobile station transmits the number of RLC data blocks corresponding to the RLC window size (WS) (i.e. if the mobile station's transmit window is stalled), the mobile station shall start timer T3182. Timer T3182 shall be stopped upon reception of an acknowledgement (piggy-backing or PACKET DBPSCH UPLINK ACK/NACK message) targetting this RLC entity. If timer T3182 expires, the mobile station shall notify a link failure to the RRC layer which shall in turn stop the corresponding RLC entity.

11.4.3.3.2 Downlink

The mobile station shall be able to receive RLC/MAC blocks in RLC unacknowledged mode on FACCH, SACCH and SDCCH. The mobile station shall, in the RLC/MAC header, identify the RRBid and decode the RLC data blocks belonging to the corresponding radio bearer.

The network may poll the mobile station for sending a PACKET CONTROL ACKNOWLEDGEMENT message by setting the polling (P) bit in a downlink RLC data block, in order to detect possible radio link failures. Upon reception by the mobile station of a polling request, the mobile station shall send a PACKET CONTROL ACKNOWLEDGEMENT message for the corresponding RLC entity to the network in the next possible uplink radio block following the rules defined in sub-clause 9.2.3 and the requirements defined in sub-clause 9.2.1.2. The PACKET CONTROL ACKNOWLEDGEMENT message shall be formatted using the normal burst format. Upon reception by the network of a PACKET CONTROL ACKNOWLEDGEMENT message for this RLC entity, the network shall stop reset counter N3107. If the network does not receive any PACKET CONTROL ACKNOWLEDGEMENT for this RLC entity before the response time specified in sub-clause 9.2.1.2, the network shall increment counter N3107. If counter $N3107=N3107_{max}$, the network shall indicate a link failure to the RRC layer which shall in turn stop the corresponding RLC entity (see sub-clause 14.3 and 3GPP TS 44.118).

11.4.4 Transparent mode operation (TCH TBF mode only)

When operating in transparent mode, the RLC protocol has no functionality. The incoming RLC SDUs are transferred to the MAC layer without being altered. No upper layer protocol information is removed. No RLC protocol information is added.

12 RLC/MAC block structure

12.1 RLC/MAC block structure

See 3GPP TS 44.060 sub-clause 10.0a.

12.2 RLC/MAC block format conventions

See 3GPP TS 44.060 sub-clause 10.0b.

12.3 Spare bits

See 3GPP TS 44.060 sub-clause 10.1.

12.4 GPRS RLC data blocks (PDTCH)

12.4.1 Downlink RLC data block

The Downlink RLC data block together with its MAC header is formatted as shown in figure 12.4.1.1.

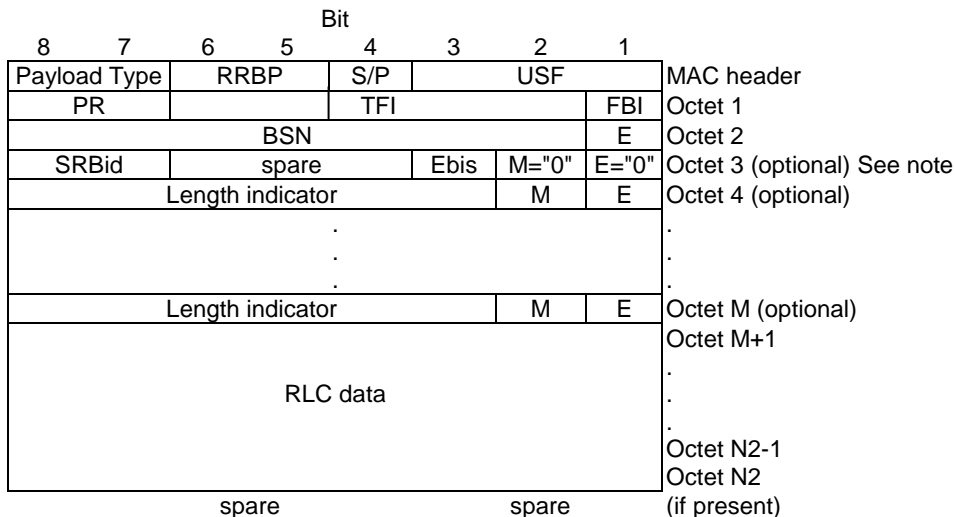

NOTE: This octet is present only in case the RLC data block is sent on SFACCH.

Figure 12.4.1.1: Downlink RLC data block with MAC header

12.4.2 Uplink RLC data block

The Uplink RLC data block together with its MAC header is formatted as shown in figure 12.4.2.1.

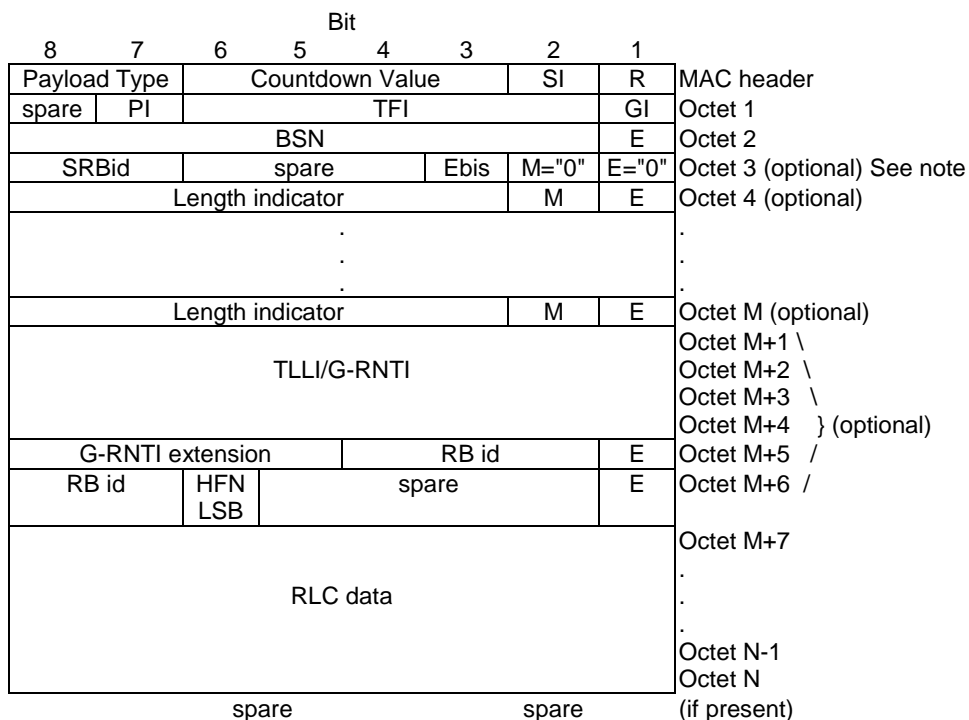

NOTE: This octet is present only in case the RLC data block is sent on SFACCH.

Figure 12.4.2.1: Uplink RLC data block with MAC header

12.5 RLC/MAC control blocks (PACCH)

See 3GPP TS 44.060 sub-clause 10.3.

12.6 EGPRS RLC data blocks and RLC/MAC headers (PDTCH)

12.6.1 General

See 3GPP TS 44.060 sub-clause 10.3a.0.

12.6.2 EGPRS downlink RLC data block

See 3GPP TS 44.060 sub-clause 10.3a.1.

12.6.3 EGPRS uplink RLC data block

The EGPRS uplink RLC data block is formatted according to figure 12.6.3.1.

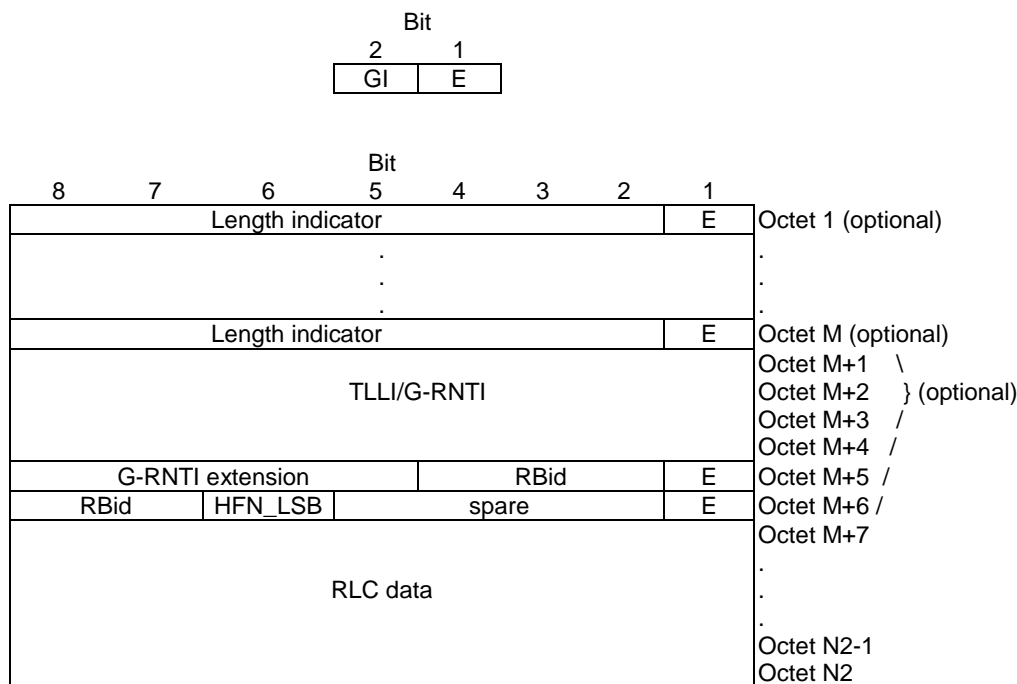

NOTE: The field mapping convention for EGPRS (see 3GPP TS 44.060 sub-clause 10.0b.3.2) applies. According to that, in particular regarding the TLLI/G-RNTI field, the *least significant octet* of the TLLI/G-RNTI value shall be mapped on octet M+1 and the *most significant octet* of the TLLI/G-RNTI value shall be mapped on octet M+4 of the uplink EGPRS RLC data block.

Figure 12.6.3.1: Uplink EGPRS RLC data block

12.6.4 EGPRS downlink RLC/MAC header

See 3GPP TS 44.060 sub-clause 10.3a.3.

12.6.5 EGPRS uplink RLC/MAC header

See 3GPP TS 44.060 sub-clause 10.3a.4.

12.7 RLC/MAC block formats on FACCH, SACCH and SDCCH

12.7.1 RLC/MAC block

The size of an RLC/MAC block on FACCH and SDCCH is 23 octets. On SACCH, it is 21 octets, due to a 2 octets physical layer header (see 3GPP TS 44.003). RLC/MAC blocks for FACCH and SDCCH, as well as SACCH blocks (RLC/MAC block together with the 2 octet physical layer header) shall always be encoded using the coding scheme CS-1 (see 3GPP TS 45.003 and 3GPP TS 44.004).

An RLC/MAC block may be for either data or control message transfer.

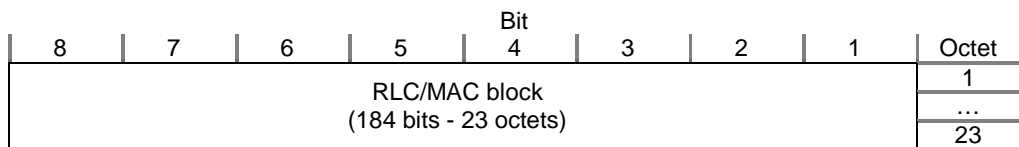

Figure 12.7.1.1: FACCH/SDCCH block

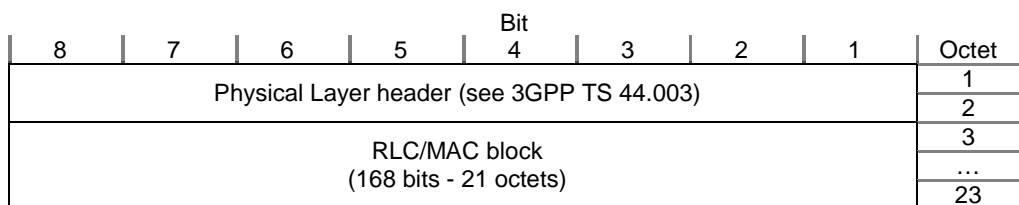
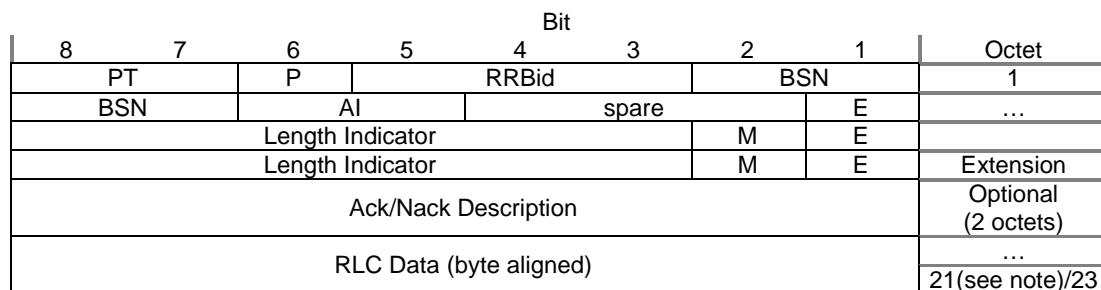

Figure 12.7.1.2: SACCH block

12.7.2 Downlink RLC/MAC block for data transfer



NOTE: 21 octets apply only in case of SACCH.

Figure 12.7.2.1: Downlink RLC/MAC block for data transfer on FACCH, SACCH and SDCCH (PT=00)

12.7.3 Uplink RLC/MAC block for data transfer

Bit								Octet	
8	7	6	5	4	3	2	1		
PT		P	RRBid			BSN			1
BSN		AI		SI	GI	spare	E	...	
Length Indicator						M	E		
Length Indicator						M	E	Extension	
Ack/Nack Description								Optional (2 octets)	
G-RNTI								Optional (4 octets)	
RLC Data (byte aligned)								...	
								21(see note)/23	

NOTE: 21 octets apply only in case of SACCH.

Figure 12.7.3.1: Uplink RLC/MAC block for data transfer on FACCH, SACCH and SDCCH (PT=00)

12.7.4 RLC/MAC block for control message transfer

The RLC/MAC block formats for control message transfer are applicable in both uplink and downlink directions.

Figure 12.7.4.1 represents the RLC/MAC block for control message transfer related to an on-going temporary block flow on FACCH, SACCH or SDCCH.

Bit								Octet	
8	7	6	5	4	3	2	1		
PT		P	RRBid			spare			1
Control Message Content								...	
								21 (see note)/23	

NOTE: 21 octets apply only in case of SACCH.

Figure 12.7.4.1: RLC/MAC block for control message transfer on FACCH, SACCH and SDCCH (PT=01)

Figure 12.7.4.2 represents the RLC/MAC block for control message transfer on FACCH related to an on-going temporary block flow on TCH. This message may be used for e.g. acknowledgement of the data transfer on TCH.

Bit								Octet
8	7	6	5	4	3	2	1	
PT		P	S	RBSN	RTI		spare	1
Control Message Content								...
								23

Figure 12.7.4.2: RLC/MAC block for control message transfer on FACCH (PT=10)

12.8 RLC/MAC block format on TCH (NT-RLC)

12.8.1 RLC/MAC block

12.8.1.1 General

Each TCH block shall contain an RLC/MAC block followed by a 24-bit frame check sequence (FCS), as illustrated in figures 12.8.1.1.1, 12.8.1.1.2 and 12.8.1.1.3.

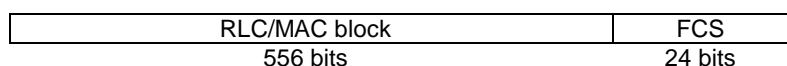

Figure 12.8.1.1.1: E-TCH/F28.8 block structure

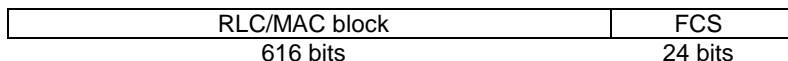

Figure 12.8.1.1.2: E-TCH/F32.0 block structure

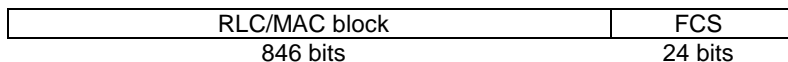

Figure 12.8.1.1.3: E-TCH/F43.2 block structure

12.8.1.2 RLC/MAC block for E-TCH/F28.8 coding scheme

Figure 12.8.1.2.1 represents the RLC/MAC block for E-TCH/F28.8 coding scheme.

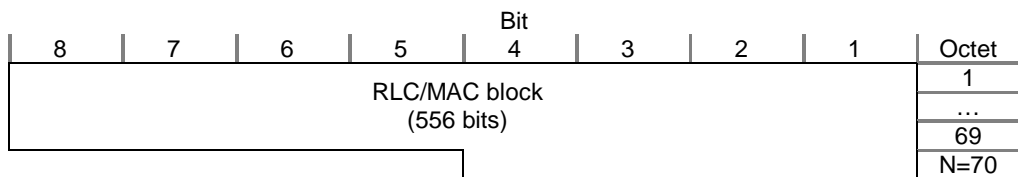

Figure 12.8.1.2.1: RLC/MAC block for E-TCH/F28.8

12.8.1.3 RLC/MAC block for E-TCH/F32.0 coding scheme

Figure 12.8.1.3.1 represents the RLC/MAC block for E-TCH/F32.0 coding scheme.

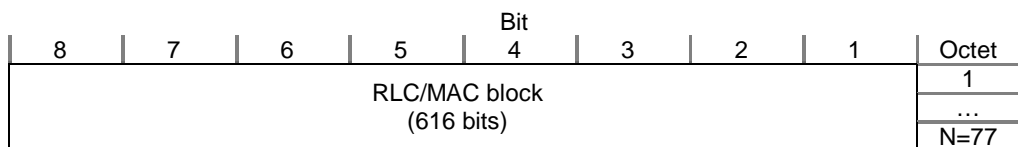

Figure 12.8.1.3.1: RLC/MAC block for E-TCH/F32.0

12.8.1.4 RLC/MAC block for E-TCH/F43.2 coding scheme

Figure 12.8.1.4.1 represents the RLC/MAC block for E-TCH/F43.2 coding scheme.

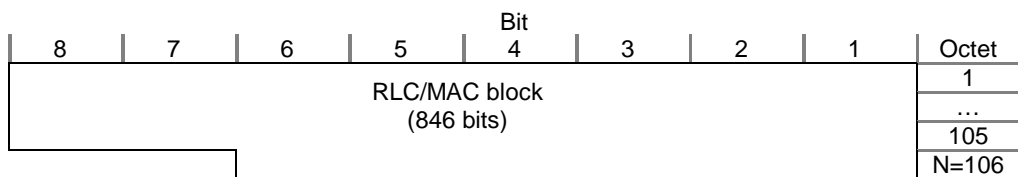

Figure 12.8.1.4.1: RLC/MAC block for E-TCH/F43.2

12.8.2 Downlink RLC/MAC block for data transfer

Figure 12.8.2.1 represents the RLC/MAC block for data transfer for E-TCH/F28.8, E-TCH/F32.0 and E-TCH/F43.2 coding schemes, achieving bit rates of 27,8 kbits/s, 30,8 kbits/s and 42,3 kbits/s respectively.

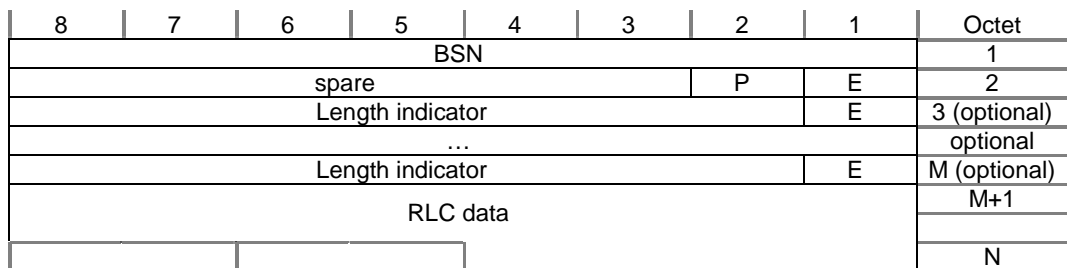

Figure 12.8.2.1: Downlink RLC/MAC block for data transfer on TCH

12.8.3 Uplink RLC/MAC block for data transfer

Figure 12.8.3.1 represents the RLC/MAC block for data transfer for E-TCH/F28.8, E-TCH/F32.0 and E-TCH/F43.2 coding schemes, achieving bit rates of 27,8 kbits/s, 30,8 kbits/s and 42,3 kbits/s respectively.

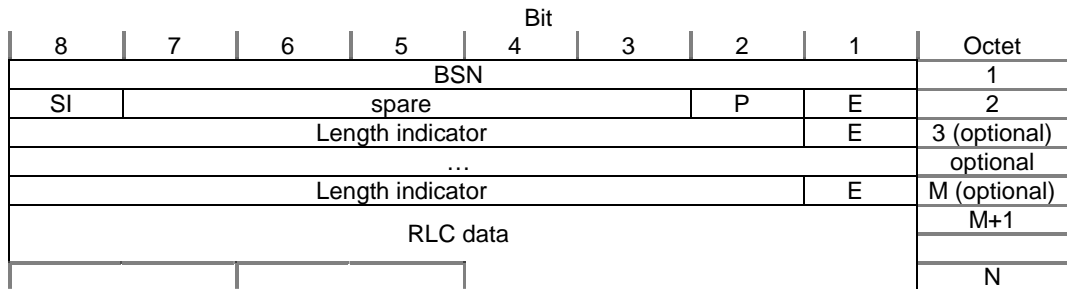

Figure 12.8.3.1: Uplink RLC/MAC block for data transfer on TCH

12.8.4 RLC/MAC block for control message transfer

RLC/MAC blocks for control message transfer shall be sent on FACCH with Payload Type = "10" as described in sub-clause 12.7.4.

12.9 Header fields

12.9.1 General

The header fields described in this sub-clause are applicable only for the blocks described in the present TS.

12.9.2 Payload Type (PT) field

The Payload Type field shall indicate the type of data contained in remainder of the RLC/MAC block. The encoding of the Payload Type field is shown in table 12.9.2.1.

Table 12.9.2.1: Payload Type (PT) field

Bit 2 1	PT: Payload Type
0 0	RLC Data block
0 1	RLC Control block related to an on-going RLC Data flow on the same logical channel (The corresponding RB is referred to with Reduced RBid field)
1 0	RLC Control block on FACCH related to an on-going RLC Data flow on TCH
1 1	Reserved

12.9.3 Polling (P) bit

The polling bit indicates whether or not the transmitter is polling for acknowledgement. It is encoded as shown in table 12.9.3.1.

Table 12.9.3.1: Polling (P) bit

Bit	P: Polling Bit
0	No polling
1	Polling: acknowledgement required

12.9.4 Reduced Radio Bearer identity (RRBid) field

The reduced radio bearer identity field provides a one-to-one mapping with the RBid of the RB to which either the RLC data block belongs, or the RLC/MAC control block relates. This field is used in the same way as is the TFI in (E)GPRS RLC/MAC blocks. It is encoded as shown in table 12.9.4.1.

Table 12.9.4.1: Reduced Radio Bearer identity (RRBid) field

Bit 3 2 1	RRBid: Reduced Radio Bearer identity
0 0 0	Signalling Radio Bearer 1
0 0 1	Signalling Radio Bearer 2
0 1 0	Signalling Radio Bearer 3
0 1 1	Signalling Radio Bearer 4
1 x x	User-plane Radio Bearer The correspondence between Reduced RBid and the RBid in this case is provided at RB setup.

12.9.5 More (M) bit and Extension (E) bit

These bits are used in the same way as is described in 3GPP TS 44.060 sub-clauses 10.4.11 and 10.4.13 for GPRS TBF mode.

12.9.6 Extension bis (Ebis) bit

The Extension bis (Ebis) bit is used to indicate the presence of an optional octet in the RLC data block header.

Table 12.9.6.1: Extension bis (Ebis) bit

bit 1	Ebis bit
0	Extension octet follows immediately
1	No extension octet follows

12.9.7 Stall Indicator (SI) bit

The Stall Indicator bit is used as is described in 3GPP TS 44.060 sub-clause 10.4.3.

12.9.8 Ack Indicator (AI) field

The Ack Indicator field indicates whether or not an acknowledgement bitmap is piggy-backed in the RLC/MAC block. It is encoded as shown in table 12.9.8.1.

Table 12.9.8.1: Ack Indicator (AI) field

Bit 2 1	AI: Ack Indicator
0 0	Ack/Nack description field not included – Reserved
0 1	Ack/Nack description not included. No retransmission requested (all RLC blocks received, similar to FINAL_ACK_INDICATION==1)
1 0	Ack/Nack description field included
1 1	Reserved

12.9.9 Ack/Nack Description field

Table 12.9.9.1: Ack/Nack Description field

Ack/Nack Description
<p>< Ack/Nack Description IE> ::=</p> <p> <Reduced RBid : bit(3)></p> <p> <STARTING_SEQUENCE_NUMBER : bit(4)></p> <p> <RECEIVED_BLOCK_BITMAP : bit(8)></p> <p>Reduced Rbid</p> <p>The reduced radio bearer identity field provides a one-to-one mapping with the RBid of the RB in the opposite direction to which the acknowledgement bitmap is targeted. It is encoded as shown in table 12.3, sub-clause 12.9.4.</p> <p>STARTING_SEQUENCE_NUMBER (SSN):</p> <p>The SSN contains the value of V(R) when this field was transmitted. This field is encoded as the binary representation of V(R). Range 0 to 15</p> <p>RECEIVED_BLOCK_BITMAP (RBB):</p> <p>The RBB is a bitmap representing Block Sequence Numbers. The bitmap is indexed relative to SSN as follows:</p> <p>$BSN = (SSN - bit_number) \text{ modulo } 16$ for bit_number=1 to 8.</p> <p>The BSN values represented range from $(SSN-1) \text{ mod } 16$ to $(SSN-8) \text{ mod } 16$. The value of each bit is encoded as:</p> <p>0: Negative acknowledgement of the RLC data block with $BSN = (SSN - bit_number) \text{ mod } 16$ 1: Positive acknowledgement of the RLC data block with $BSN = (SSN - bit_number) \text{ mod } 16$. Mapping of the bitmap is defined in sub-clause 11.</p>

12.9.10 G-RNTI indicator (GI) bit

The G-RNTI indicator bit indicates the presence of an optional G-RNTI field within the RLC data block, when on SDCCCH. It is encoded as shown in table 12.9.10.1.

Table 12.9.10.1: G-RNTI indicator (GI) bit

Bit	GI: G-RNTI indicator bit
0	G-RNTI field is not present
1	G-RNTI field is present

12.9.11 Segmentation (S) bit

The Segmentation bit indicates whether or not the RLC/MAC control block is a segment of an RLC/MAC control message. It is encoded as shown in table 12.9.11.1.

Table 12.9.11.1: Segmentation (S) bit

Bit	S: Segmentation bit
0	The RLC/MAC control block contains an entire RLC/MAC control message
1	The RLC/MAC control block is a segment of an RLC/MAC control message

12.9.12 Reduced Block Sequence Number (RBSN) bit

The Reduced Block Sequence Number (RBSN) bit carries the sequence number of the RLC/MAC control blocks. The RBSN bit is encoded as a binary number with range 0 to 1. The RBSN bit is present if and only if the S bit is set (see sub-clause 12.9.11).

12.9.13 (void)

12.9.14 Radio Transaction Identifier (RTI) field

The Radio Transaction Identifier (RTI) field is used to group the RLC/MAC control blocks that make up an RLC/MAC control message and identifies the segmented control message sequence with which the RLC/MAC control block is associated. The RTI field is 2 bits in length with range 0 to 3. The RTI field is present if and only if the S bit is set (see sub-clause 12.9.11). The RTI is unique on a given logical channel in a given direction.

NOTE: An RTI value may be repeated in both directions on a given logical channel (e.g. FACCH uplink and FACCH downlink), and across logical channels (e.g.. FACCH and SACCH).

12.9.15 Block Sequence Number (BSN) field

The Block Sequence Number (BSN) field carries the sequence absolute Block Sequence Number (BSN') modulo Sequence Number Space (SNS) (16 in DCCH TBF mode, 256 in TCH TBF mode (NT-RLC)) of each RLC data block within the TBF.

In DCCH TBF mode, the BSN is 4 bits in length and is encoded as a binary number with range 0 to 15.

In TCH TBF mode (NT-RLC), the BSN is 8 bits in length and is encoded as a binary number with range 0 to 255.

12.9.16 Radio Bearer Identity (RB Id) field

The Rb Id uniquely identifies a Radio Bearer. This field is encoded as a binary number with range 0-31.

12.9.17 Signalling Radio Bearer Identity (SRB Id) field

The Signalling Radio Bearer Identity (SRB Id) field is used to identify the SRB to which the RLC data block belongs. It is encoded as shown in table 12.9.17.1.

Table 12.9.17.1: Signalling Radio Bearer Identity (SRB Id) field

Bit 2 1	SRB Id: Signalling Radio Bearer Identity
0 0	SRB1
0 1	SRB2
1 0	SRB3
1 1	SRB4

12.9.18 GERAN Radio Network Temporary Identity Extension (G-RNTI Extension) field

This field contains the extra 4 bits of the G-RNTI not included in the TLLI / G-RNTI field.

12.9.19 Length Indicator (LI) field

The Length Indicator bit is used as is described in 3GPP TS 44.060 sub-clauses 10.4.14 and 10.4.14a.

12.9.20 PFI Indicator (PI) field

The PFI Indicator is not used in *Iu mode*.

12.9.21 HFN Least Significant Bit (HFN_LSB) field

The HFN Least Significant Bit (HFN_LSB) field contains the least significant bit of the HFN of the radio bearer to which the RLC/MAC block belongs, in the direction where this RLC/MAC block is sent.

13 Ciphering

13.1 General

The ciphering function is performed either in the RLC sublayer or in the MAC sublayer according to the following rules:

- The RLC sublayer is responsible for ciphering/deciphering RLC data blocks in case of non-transparent RLC mode (unacknowledged or acknowledged).
- The MAC sublayer is responsible for ciphering/deciphering user data in case of transparent RLC mode. It is also responsible for ciphering/deciphering some RLC/MAC control messages.

The ciphering function shall use the ciphering algorithm f8 specified in 3GPP TS 35.201. Four input parameters are necessary to configure the ciphering algorithm:

- *Ciphering key*: the 128-bit *ciphering key* is received from RRC by means of interlayer primitive.
- *Bearer*: the 5-bit *bearer* indicates, when available, the radio bearer identity of the radio bearer to cipher. It is received from RRC by means of interlayer primitive.
- *Direction*: the 1-bit *direction* indicates the direction of transmission, uplink or downlink, of the flow to cipher.
- *Count*: the 32-bit *count* is used to ensure that the blocks of a same flow are all ciphered differently.

A fifth parameter, *Length*, is used to indicate the length in bits of the plain data to cipher. Plain, ciphered and deciphered data are of the same length. Length is not input to the ciphering algorithm.

13.2 Applicability of ciphering

Ciphering may apply only between the mobile station and the serving BSS when contention resolution is successfully completed, i.e. uplink data (respectively downlink data) between the mobile station and the serving BSS may be ciphered after contention is successfully completed on mobile station side (respectively serving BSS side).

13.3 Ciphering at RLC sublayer

13.3.1 General

The RLC sublayer is responsible for ciphering/deciphering RLC data blocks in case of non-transparent RLC mode (unacknowledged or acknowledged).

For a given radio bearer, ciphering/deciphering is ordered by RRC by means of the CRLC-CONFIG-Req primitive containing the necessary ciphering elements (see sub-clause 4.3.3). Upon receipt of the CRLC-CONFIG-Req primitive containing the ciphering elements, ciphering shall be performed at RLC sublayer according to these ciphering elements for the corresponding radio bearer. Ciphering shall not be performed at RLC sublayer otherwise.

13.3.2 Parameter settings

13.3.2.1 Input parameters to the ciphering algorithm

Table 13.3.2.1.1 defines how to set the input parameters to the ciphering algorithm.

Table 13.3.2.1.1: Input parameters to the ciphering algorithm

Input parameters	Size in bits		Settings				
			TBF mode (see note 1)	DCCH	TCH	GPRS	EGPRS
Count	32	MSB	HFN (see note 2)	27 bits <i>0...134217727</i>	23 bits <i>0...8388607</i>	24 bits <i>0...16777215</i>	20 bits <i>0...1048575</i>
		LSB	RBid indicator	1 bit 1 (RBid available)			
	BSN		4 bits <i>0...15</i>	8 bits <i>0...255</i>	7 bits <i>0...127</i>	11 bits <i>0...2047</i>	
Direction	1	Direction	1 bit 0 (uplink) 1 (downlink)				
Bearer	5	RBid	5 bits <i>0...31</i>				
Length	10	Length in bits of the plain data to cipher	10 bits <i>0...592</i>				
NOTE 1: Four cases are distinguished as per the format of the BSN used in the RLC data block to cipher, according to the TBF mode: DCCH TBF mode, TCH TBF mode, GPRS TBF mode and EGPRS TBF mode.							
NOTE 2: The handling of the HFN is described in sub-clause 13.3.2.2.							
NOTE 3: The values in italic represent the range for a given parameter.							

13.3.2.2 Handling of the HFN

The HFN is radio bearer specific.

In RLC acknowledged mode, the HFN used at retransmission of an RLC data block shall be the same as the one used at original transmission of this RLC data block.

The HFN shall be increased by one at every cycle of the BSN, when the BSN reaches 0.

Further handling of the HFN is described in 3GPP TS 44.118.

13.3.3 Cipherng of RLC PDUs in non-transparent RLC mode

Cipherng may only apply on the payload of the RLC PDUs. For instance, if MCS-9 is used, only the 592 bits of the payload of each of the two RLC data blocks in the RLC/MAC block may be cipherng.

13.4 Cipherng at MAC sublayer

13.4.1 General

The MAC sublayer is responsible for cipherng/decipherng user data in case of transparent RLC mode. It is also responsible for cipherng some RLC/MAC control messages.

For a given radio bearer, cipherng/decipherng is ordered by RRC by means of the CMAC-CONFIG-Req primitive containing the necessary cipherng elements (see sub-clause 4.3.4). Upon receipt of the CMAC-CONFIG-Req primitive containing the cipherng elements, cipherng/decipherng shall be performed at MAC sublayer according to these cipherng elements for the corresponding radio bearer. Cipherng shall not be performed at MAC sublayer otherwise.

13.4.2 Parameter settings

13.4.2.1 Input parameters to the cipherng algorithm

Table 13.4.2.1.1 defines how to set the input parameters to the cipherng algorithm in case of transparent RLC mode.

Table 13.4.2.1.1: Input parameters to the cipherng algorithm for layer 2 data in transparent RLC mode

Input parameters	Size in bits	Settings	
Count	32 MSB	HFN (see note 1)	11 bits <i>0...2047</i>
		TDMA Frame Number (see note 2)	17 bits
	LSB	RBid indicator	1 bit 1 (RBid available)
		Timeslot number	3 bits <i>0...7</i>
Direction	1	Direction	1 bit 0 (uplink) 1 (downlink)
Bearer	5	RBid	5 bits <i>0...31</i>
Length	N	Length in bits of the plain data to cipher	Size of the RLC PDU (see note 3)
NOTE 1: The handling of the HFN is described in sub-clause 13.4.2.2.1.			
NOTE 2: The 17-bit TDMA Frame Number is described below.			
NOTE 3: In transparent RLC mode, the size of an RLC PDU equals that of the RLC SDU it carries.			
NOTE 4: The values in <i>italic</i> represent the range for a given parameter.			

Table 13.4.2.1.2 defines how to set the input parameters to the cipherng algorithm for cipherng of RLC/MAC control messages. The rules for cipherng RLC/MAC control messages are given in sub-clause 13.4.3.

Table 13.4.2.1.2: Input parameters to the ciphering algorithm for RLC/MAC control messages

Input parameters	Size in bits	Settings	
Count	32 MSB	HFN (see note 1)	11 bits <i>0...2047</i>
		TDMA Frame Number (see note 2)	17 bits
	LSB	RBid indicator	1 bit <i>0</i> (RBid not available)
		Timeslot number	3 bits <i>0...7</i>
Direction	1	Direction	1 bit <i>0</i> (uplink) <i>1</i> (downlink)
Bearer	5	RBid	5 bits <i>"00000"</i>
Length	9	Length in bits of the plain data to cipher	9 bits <i>0...368</i> (see note 3)
NOTE 1: The handling of the HFN is described in sub-clause 13.4.2.2.2. NOTE 2: The 17-bit TDMA Frame Number is described below. NOTE 3: The length in bits of the plain data to cipher can be derived from the rules given in sub-clause 13.4.3 on a per RLC/MAC control message basis. NOTE 4: The values in <i>italic</i> represent the range for a given parameter.			

The 17-bit TDMA Frame Number is constructed as follows:

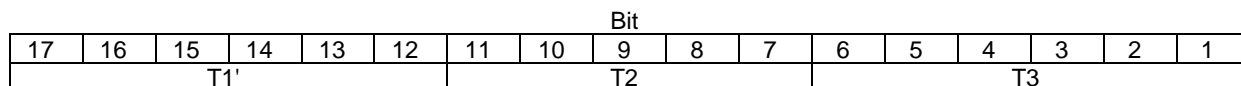

Figure 13.4.2.1.1: 17-bit TDMA Frame Number

- T1' (6 bits) range 0 to 63 = T1 mod 64.
- T2 (5 bits) range 0 to 25 = FN mod 26 as defined in 3GPP TS 45.002.
- T3 (6 bits) range 0 to 50 = FN mod 51 as defined in 3GPP TS 45.002.

where

$T1 = FN \text{ div } (26 \times 51)$ as defined in 3GPP TS 45.002.

and

FN = TDMA frame number as defined in 3GPP TS 45.002.

13.4.2.2 Handling of the HFN

13.4.2.2.1 Ciphering in transparent RLC mode

The HFN is radio bearer specific. It shall obey the following rules for the lifetime of the corresponding radio bearer:

- It shall be incremented by 1 every time the TDMA Frame Number is smaller than the previous one.
- It shall also be incremented by 1 at every cell change.

Further handling of the HFN is described in 3GPP TS 44.118.

13.4.2.2.2 Cipherng of RLC/MAC control messages

The HFN presented in table 13.3 shall obey the following rules:

- It shall be reset to START value every time a new authentication is made.
- During an RRC connection:
 - It shall be incremented by 1 every time the TDMA Frame Number is smaller than the previous one.
 - It shall also be incremented by 1 at every cell change.
- It shall be incremented by 1 at every new RRC connection and notified to the network at RRC connection set-up see 3GPP TS 44.118.

13.4.3 Cipherng of RLC/MAC control messages

The following RLC/MAC control messages may be ciphered:

- PACKET RESOURCE REQUEST, PACKET UPLINK ASSIGNMENT, MULTIPLE TBF UPLINK ASSIGNMENT, PACKET DOWNLINK ASSIGNMENT, MULTIPLE TBF DOWNLINK ASSIGNMENT, PACKET DBPSCH ASSIGNMENT, PACKET UPLINK ACK/NACK, PACKET DBPSCH UPLINK ACK/NACK, PACKET DOWNLINK ACK/NACK, EGPRS PACKET DOWNLINK ACK/NACK, PACKET DBPSCH DOWNLINK ACK/NACK, PACKET TIMESLOT RECONFIGURE, MULTIPLE TBF TIMESLOT RECONFIGURE, PACKET TBF RELEASE and PACKET CELL CHANGE ORDER, PHYSICAL INFORMATION.

NOTE 1: This list should be updated according to the RLC/MAC development i.e. if new messages are created or if some of the messages in this list are no more applicable to *Iu mode*. The list of Fields and IEs in the table below will also be updated according to the RLC/MAC development.

Within these messages, all CSN-1 syntax bits shall be kept unciphered. Furthermore, the ciphering of these messages shall obey the rules given in table 13.4.3.1.

NOTE 2: An informative annex will be introduced to illustrate an example of ciphering of an RLC/MAC control message.

Table 13.4.3.1: Cipherng of RLC/MAC control messages

RLC/MAC Control Message	Direction	Fields and IEs that shall be kept unciphered
-------------------------	-----------	--

Packet Resource Request	Uplink	Message type, GLOBAL_TFI, Length of MS RA capabilities, Length
Packet Uplink Assignment	Downlink	Message type, PAGE_MODE, PERSISTENCE_LEVEL, GLOBAL_TFI, TLLI/G-RNTI, G-RNTI extension, TQI, Length of MA Frequency List contents, MA_LENGTH
Multiple TBF Uplink Assignment	Downlink	Message type, PAGE_MODE, PERSISTENCE_LEVEL, GLOBAL_TFI, TLLI/G-RNTI, G-RNTI extension
Packet Downlink Assignment	Downlink	Message type, PAGE_MODE, PERSISTENCE_LEVEL, GLOBAL_TFI, TLLI/G-RNTI, G-RNTI extension, Length of MA Frequency List contents, MA_LENGTH
Multiple TBF Downlink Assignment	Downlink	Message type, PAGE_MODE, PERSISTENCE_LEVEL, GLOBAL_TFI, TLLI/G-RNTI, G-RNTI extension
Packet DBPSCH Assignment	Downlink	Message type, PAGE_MODE, PERSISTENCE_LEVEL, GLOBAL_TFI, G-RNTI
Packet Uplink Ack/Nack	Downlink	Message type, PAGE_MODE, UPLINK_TFI, CONTENTION_RESOLUTION_ G-RNTI, G-RNTI extension, Extension length, COMPRESSED_BITMAP_LENGTH
Packet DBPSCH Uplink Ack/Nack	Downlink	Message type, RBId
Packet Downlink Ack/Nack	Uplink	Message type, DOWNLINK_TFI
EGPRS Packet Downlink Ack/Nack	Uplink	Message type, DOWNLINK_TFI, Extension length, COMPRESSED_BITMAP_LENGTH
Packet DBPSCH Downlink Ack/Nack	Uplink	Message type, RBId
Packet Timeslot Reconfigure	Downlink	Message type, PAGE_MODE, GLOBAL_TFI, Length of MA Frequency List contents, MA_LENGTH
Multiple TBF Timeslot Reconfigure	Downlink	Message type, PAGE_MODE, GLOBAL_TFI
Packet TBF Release	Downlink	Message type, PAGE_MODE, GLOBAL_TFI
Packet Cell Change Order	Downlink	Message type, PAGE_MODE, GLOBAL_TFI, TLLI/G-RNTI, G-RNTI extension, NR_OF_REMOVED_FREQ, NR_OF_FREQUENCIES, FREQ_DIFF_LENGTH
Physical Information	Downlink	Message type

13.4.4 Cipherng of RLC PDUs in transparent RLC mode

Cipherng applies on the complete RLC PDUs.

14 RLC suspension, stop and re-establishment procedures

14.1 General

This sub-clause describes the following RLC procedures: suspend/resume, stop/continue and re-establishment. These procedures are requested by RRC (see 3GPP TS 44.118), and are applicable in NT-RLC only. Suspend/resume is used when e.g. cipherng parameters are changed. Stop/continue and re-establishment are used during e.g. RB reconfiguration.

14.2 Local suspend/resume function (NT-RLC)

The upper layers may suspend/resume a RLC entity. Suspension of a RLC entity is ordered through the CRLC-SUSPEND-Req primitive (see sub-clause 4.3.3). Resumption is ordered through the CRLC-RESUME-Req primitive (see sub-clause 4.3.3).

When a RLC entity operating in unacknowledged mode is suspended by upper layers with the parameter N, the RLC entity shall:

- acknowledge the suspend request through the CRLC-SUSPEND-Conf primitive containing the current value of the send-state variable $V(S)$;
- not send any RLC data block with a "Block Sequence Number" $BSN \geq (V(S) + N)$ modulo SNS;
- send Packet Uplink/Downlink Dummy control blocks on allocated radio resources if there is no other RLC/MAC control message to be sent.

When a RLC entity operating in acknowledged mode is suspended by upper layers with the parameter N , the RLC entity shall:

- acknowledge the suspend request through the CRLC-SUSPEND-Conf primitive containing the current value of the send-state variable $V(S)$;
- not send any RLC data block with "Block Sequence Number" $BSN \geq (V(S) + N)$ modulo SNS;
- proceed with retransmission procedures for RLC data blocks with $BSN < (V(S) + N)$ modulo SNS as defined in sub-clauses 10.4.5 and 11.4.2;
- send Packet Uplink/Downlink Dummy control blocks on allocated radio resources if there is no other RLC/MAC control message or RLC data block to be sent.

When a RLC entity operating in unacknowledged mode is resumed by upper layers, the RLC entity shall:

- resume data transfer procedure.

When a RLC entity operating in acknowledged mode is resumed by upper layers, the RLC entity shall:

- resume data transfer procedure.

14.3 Stop/continue function (NT-RLC)

The RLC stop/continue procedure is applicable on DBPSCHs only.

The upper layer may stop/continue a RLC entity. Stop of a RLC entity is ordered through the CRLC-CONFIG-Req primitive (see sub-clause 4.3.3). Continuation of a RLC entity is ordered through the CRLC-CONFIG-Req primitive (see sub-clause 4.3.3).

When a uplink RLC entity is stopped, the mobile station shall pause the timers T3180 and T3182 if running. When a downlink RLC entity is stopped, the mobile station shall pause timer T3190 if running.

When an uplink RLC entity is continued, the mobile station shall continue the timers T3180 and T3182 if paused. When a downlink RLC entity is continued, the mobile station shall start timer T3190 if paused.

When a RLC entity is stopped by upper layers, the RLC entity shall:

- not submit any RLC data blocks to lower layer or accept any RLC data blocks;
- not submit any RLC/MAC control message to lower layer or accept any RLC/MAC control message;
- save all state variables.

When a RLC entity is continued by upper layers, the RLC entity shall:

- if the RLC entity is stopped:
 - continue the data transmission and reception from the stored state variables.
- otherwise, if the RLC is not stopped:
 - take no action.

14.4 RLC re-establishment function (NT-RLC)

The RLC re-establishment function is applicable in NT-RLC only, on DBPSCHs only.

The upper layers may re-establish a RLC entity. Re-establishment of a RLC entity is ordered through the RLC-CONFIG-Req primitive (see sub-clause 4.3.3).

When a RLC entity is re-established by upper layers, the RLC entity shall:

- reset the state variables to their initial value;
- set the configurable parameters (e.g. EGPRS RLC window size) to their configured value;
- set the hyper frame number (HFN) in UL and DL to the value configured by upper layers;
- if the RLC entity is operating in unacknowledged mode:
 - if it is a receiving RLC entity:
 - discard all RLC data blocks (PDUs).
 - if it is a transmitting RLC entity:
 - discard the RLC SDUs for which one or more segments have been submitted to the MAC layer.
- otherwise if the RLC entity is operating in acknowledged mode:
 - discard all RLC data blocks (PDUs) and RLC/MAC control messages for this RLC entity.

Annex A (informative): Change History

Date / Meeting	TSG Doc.	CR	Rev	Subject/Comment	New
GP-10	GP-022099			First version	5.0.0
GP-11	GP-022763	001	1	Clarification of SI 13-Alt in table 5.4.2.1.4	5.1.0
GP-11	GP-022764	002	1	Ciphering of PACKET DBPSCH ACK/NACK messages	5.1.0
GP-11	GP-022254	003		Clarification of measurement reporting	5.1.0
GP-11	GP-022248	004		Clarification on countdown value for SFACCH	5.1.0
GP-11	GP-022245	005		Correction TCH T-RLC	5.1.0
GP-11	GP-022760	008	1	HFN synchronization at TBF establishment on SBPSCH	5.1.0
GP-11	GP-022246	009		MS synchronization when no RLC/MAC block scheduled for transmission on DBPSCH	5.1.0
GP-11	GP-022805	010	2	System performance requirements in TCH and DCCH TBF modes	5.1.0
GP-11	GP-022225	011		Abnormal cases for TBF establishment during Packet Cell Change Order	5.1.0
GP-11	GP-022668	012	1	Abnormal cases for TBF establishment via PCCCH	5.1.0
GP-11	GP-022804	013	2	USF scheduling for PDTCH on DBPSCH	5.1.0
GP-11	GP-022673	014	1	Incorrect reference to 44.060 in two phase access procedures	5.1.0
GP-11	GP-022675	016	1	Correction to RLC/MAC PDU format	5.1.0
GP-11	GP-022803	017	2	SFACCH operation	5.1.0
GP-11	GP-022767	019	1	List of RLC/MAC Control messages that may be sent on the SACCH, SDCCH, FACCH and PACCH when mapped onto DBPSCH	5.1.0
GP-11	GP-022798	020	2	Description of the cause and message to be used upon uplink access in lu mode	5.1.0
GP-11	GP-022650	022		Clarification on T3190 management	5.1.0
GP-11	GP-022808	023	1	Removal of thresholds T1 and T2 for mapping of SRBs on logical channels	5.1.0
GP-12	GP-022922	015	2	Add abnormal cases to sub-clause 8	5.2.0
GP-12	GP-023160	024	1	Section 8 - Multiple TBFs for lu mode only	5.2.0
GP-12	GP-022905	025		Handover Access and Physical Information	5.2.0
GP-12	GP-023253	026	2	Clarification on 51-multiframe structure and DBPSCH: inclusion of DBPSCH/S	5.2.0
GP-12	GP-022906	027		Correction RLC SDU Discard	5.2.0
GP-12	GP-022907	028		Removal of timer T3197	5.2.0
GP-12	GP-023104	029	1	Abnormal Cases for DBPSCH operation	5.2.0
GP-12	GP-022918	030	1	Addition of GERAN lu Mode Support Indication in SI4, SI7 and SI8	5.2.0
GP-12	GP-023366	031	2	Definition of RLC Buffer	5.2.0
GP-13	GP-030092	032		Wrong implementation of CR 44.160 030r1 (GP-022918)	5.3.0
GP-13	GP-030094	033	1	Correction to abnormal cases for multiple TBF	5.3.0
GP-13	GP-030096	034	1	Use and interpretation of RTI	5.3.0
GP-13	GP-030091	035		Correction to RLC/MAC procedures during contention resolution on SBPSCH	5.3.0
GP-13	GP-030093	036		Removal of the Final Segment bit on DBPSCH (for FACCH, SACCH and SDCCH)	5.3.0
GP-13	GP-030329	037	2	Correction to mapping of SRBs onto logical channels	5.3.0
GP-13	GP-030095	038		MS requirements on simultaneous RLC/MAC transactions and MTBF	5.3.0
GP-13	GP-030223	039		USF Handling on DBPSCH	5.3.0
GP-13	GP-030311	040	1	Correction to 2-phase access in lu mode (MTBF)	5.3.0
GP-13	GP-030225	041		Correction to RLC/MAC procedures during contention resolution on SBPSCH (MTBF)	5.3.0
GP-13	GP-030308	042	1	Correction to contention resolution at 1-phase access on DBPSCH	5.3.0
GP-13	GP-030307	043	1	Correction to access causes in lu mode	5.3.0
GP-13	GP-030228	044		Wrong Length Indicator in TCH TBF mode	5.3.0
GP-14	GP-030624	046		PACKET DBPSCH ASSIGNMENT received before T3170 expires	5.4.0
GP-14	GP-030634	047	1	Correction to wrong references to PACKET DL ACK/NACK message instead of EGPRS PACKET DL ACK/NACK message	5.4.0
GP-14	GP-030627	048		Wrong implementation CR 042r1	5.4.0
GP-14	GP-031021	049	1	Multi-block allocation for two-phase access	5.4.0
GP-14	GP-030803	050		RLC/MAC Control block size on FACCH, SDCCH	5.4.0
GP-14	GP-030937	051	1	Transmission of Handover Access and Physical Information	5.4.0
GP-14	GP-030806	053		Removal Fixed Allocation parameters from ciphering	5.4.0
GP-14	GP-030938	054	1	SFACCH and SRB2 in MAC-DTM state	5.4.0
GP-14	GP-030810	057		Incorrect implementation CR 24r1	5.4.0
GP-14	GP-030836	059		The removal of the incorret text from broadcast procedure	5.4.0
GP-15	GP-031176	056	2	Maximum TBF capacity	5.5.0
GP-15	GP-031177	060	1	Retransmission of lu mode channel request description during a DL TBF	5.5.0
GP-15	GP-031675	063	2	Transfer of RLC/MAC blocks on PDTCH+PACCH in DBPSCH configuration	5.5.0
GP-15	GP-031532	064		Timer T3200 on DBPSCH	5.5.0

History

Document history		
V5.0.0	June 2002	Publication
V5.1.0	September 2002	Publication
V5.2.0	December 2002	Publication
V5.3.0	February 2003	Publication
V5.4.0	April 2003	Publication
V5.5.0	July 2003	Publication