

ETSI TS 145 005 V10.5.0 (2012-07)



**Digital cellular telecommunications system (Phase 2+);
Radio transmission and reception
(3GPP TS 45.005 version 10.5.0 Release 10)**



Reference

RTS/TSGG-0145005va50

Keywords

GSM

ETSI

650 Route des Lucioles
F-06921 Sophia Antipolis Cedex - FRANCE

Tel.: +33 4 92 94 42 00 Fax: +33 4 93 65 47 16

Siret N° 348 623 562 00017 - NAF 742 C
Association à but non lucratif enregistrée à la
Sous-Préfecture de Grasse (06) N° 7803/88

Important notice

Individual copies of the present document can be downloaded from:

<http://www.etsi.org>

The present document may be made available in more than one electronic version or in print. In any case of existing or perceived difference in contents between such versions, the reference version is the Portable Document Format (PDF). In case of dispute, the reference shall be the printing on ETSI printers of the PDF version kept on a specific network drive within ETSI Secretariat.

Users of the present document should be aware that the document may be subject to revision or change of status. Information on the current status of this and other ETSI documents is available at

<http://portal.etsi.org/tb/status/status.asp>

If you find errors in the present document, please send your comment to one of the following services:

http://portal.etsi.org/chaicor/ETSI_support.asp

Copyright Notification

No part may be reproduced except as authorized by written permission.
The copyright and the foregoing restriction extend to reproduction in all media.

© European Telecommunications Standards Institute 2012.
All rights reserved.

DECT™, **PLUGTESTS™**, **UMTS™** and the ETSI logo are Trade Marks of ETSI registered for the benefit of its Members.
3GPP™ and **LTE™** are Trade Marks of ETSI registered for the benefit of its Members and of the 3GPP Organizational Partners.
GSM® and the GSM logo are Trade Marks registered and owned by the GSM Association.

Intellectual Property Rights

IPRs essential or potentially essential to the present document may have been declared to ETSI. The information pertaining to these essential IPRs, if any, is publicly available for **ETSI members and non-members**, and can be found in ETSI SR 000 314: *"Intellectual Property Rights (IPRs); Essential, or potentially Essential, IPRs notified to ETSI in respect of ETSI standards"*, which is available from the ETSI Secretariat. Latest updates are available on the ETSI Web server (<http://ipr.etsi.org>).

Pursuant to the ETSI IPR Policy, no investigation, including IPR searches, has been carried out by ETSI. No guarantee can be given as to the existence of other IPRs not referenced in ETSI SR 000 314 (or the updates on the ETSI Web server) which are, or may be, or may become, essential to the present document.

Foreword

This Technical Specification (TS) has been produced by ETSI 3rd Generation Partnership Project (3GPP).

The present document may refer to technical specifications or reports using their 3GPP identities, UMTS identities or GSM identities. These should be interpreted as being references to the corresponding ETSI deliverables.

The cross reference between GSM, UMTS, 3GPP and ETSI identities can be found under <http://webapp.etsi.org/key/queryform.asp>.

Contents

Intellectual Property Rights	2
Foreword.....	2
Foreword.....	10
1 Scope	11
1.1 References	12
1.2 Abbreviations	13
1.3 Definitions	13
2 Frequency bands and channel arrangement.....	14
3 Reference configuration	16
4 Transmitter characteristics	17
4.1 Output power.....	17
4.1.1 Mobile Station	17
4.1.2 Base station.....	21
4.1.2.1 Additional requirements for PCS 1 900 and MXM 1900 Base stations.....	23
4.1.2.2 Additional requirements for GSM 850 and MXM 850 Base stations	23
4.1.2.3 Additional requirements for GSM 700 Base stations.....	23
4.2 Output RF spectrum	23
4.2.1 Spectrum due to the modulation and wide band noise.....	24
4.2.1.1 General requirements for all types of Base stations and MS.....	24
4.2.1.2 Additional requirements for multicarrier BTS	24
4.2.1.3 Tables for spectrum requirements due to modulation and wideband noise.....	25
4.2.1.4 Exceptions for spectrum due to modulation and wideband noise	29
4.2.1.4.1 Mobile Stations and Base Transceiver Stations except multicarrier BTS	29
4.2.1.4.2 Multicarrier BTS	30
4.2.2 Spectrum due to switching transients	30
4.2.2.1 General requirements	30
a) Mobile Station:.....	31
b) Base transceiver station:.....	32
4.3 Spurious emissions	32
4.3.1 Principle of the specification	32
4.3.2 Base Transceiver Station	34
4.3.2.1 General requirements	34
4.3.2.2 Additional requirements for co-existence with GSM systems on other frequency bands.....	35
4.3.2.3 Additional requirements for co-existence with 3 G	36
4.3.3 Mobile Station	37
4.3.3.1 Mobile Station GSM 400, T-GSM 810, GSM 900 and DCS 1 800.....	37
4.3.3.2 Mobile Station GSM 700, GSM 850 and PCS 1 900.....	38
4.4 Radio frequency tolerance.....	39
4.5 Output level dynamic operation	39
4.5.1 Base Transceiver Station	39
4.5.2 Mobile Station	39
4.6 Modulation accuracy	40
4.6.1 GMSK modulation.....	40
4.6.2 QPSK, AQPSK, 8-PSK, 16-QAM and 32-QAM modulations	40
4.6.2.1 RMS EVM	41
4.6.2.1.1 MS requirements	41
4.6.2.1.2 Requirements for BTS.....	41
4.6.2.2 Origin Offset Suppression.....	42
4.6.2.3 Peak EVM.....	42
4.6.2.4 95:th percentile.....	42
4.7 Intermodulation attenuation.....	42
4.7.1 Base transceiver station	43
4.7.2 Intra BTS intermodulation attenuation	43

4.7.2.1	GSM 400, GSM 900, DCS 1800.....	43
a)	Requirements for BTS except multicarrier BTS.....	43
b)	Requirements for multicarrier BTS	43
4.7.2.2	MXM 850 and MXM 1900	43
4.7.2.3	GSM 700, GSM 850 and PCS 1900.....	44
a)	Requirements for BTS except multicarrier BTS.....	44
b)	Requirements for multicarrier BTS	44
c)	Additional requirements for all BTS	44
4.7.3	Void	45
4.7.4	Mobile PBX (GSM 900 only).....	45
5	Receiver characteristics	45
5.1	Blocking characteristics	45
5.1.1	Definitions of applicable frequency ranges	45
5.1.2	Requirements for MS.....	47
5.1.3	Requirements for BTS	48
5.1.4	Signal levels of blocking signal	49
5.1.5	Micro- and pico-BTS	52
5.2	AM suppression characteristics	52
5.2.1	Requirements for MS.....	52
5.2.2	Requirements for BTS	52
5.3	Intermodulation characteristics	53
5.3.1	Requirements for MS.....	53
5.3.2	Requirements for BTS	53
5.4	Spurious emissions	54
6	Transmitter/receiver performance	54
a)	MS conditions	54
b)	BTS conditions	55
6.1	Nominal Error Rates (NER)	55
6.1.1	GMSK modulation.....	55
6.1.1.1	General performance requirements	55
6.1.1.2	Requirements for MS	56
6.1.1.3	Requirements for BTS.....	56
6.1.2	QPSK/8-PSK modulation	56
6.1.2.1	Requirements for MS	56
6.1.2.2	Requirements for BTS.....	57
6.1.3	16-QAM/32-QAM modulation.....	58
6.1.3.1	Requirements for MS	58
6.1.3.2	Requirements for BTS.....	58
6.2	Reference sensitivity level.....	59
6.2.1	Circuit-switched channels.....	59
6.2.1a	Reference performance in VAMOS mode	61
6.2.2	Packet-switched channels	61
6.2.3	Flexible Layer One	63
6.2.4	Repeated associated control channel performance	63
6.2.5	Enhanced MS receiver performance	63
6.2.6	Additional performance conditions.....	64
6.3	Reference interference level	65
6.3.1	GMSK modulated speech channels and associated control channels	65
6.3.2	Co-channel reference interference performance	65
6.3.2.1	MS requirements	65
6.3.2.2	BTS requirements	65
6.3.3	Adjacent channel reference interference performance	66
6.3.3.1	Normal symbol rate used	66
6.3.3.1.1	MS requirements	66
6.3.3.1.2	BTS requirements.....	67
6.3.3.2	Higher symbol rate used:	67
6.3.3.2.1	MS requirements	67
6.3.3.2.2	BTS requirements.....	67
6.3.4	Reference interference performance – signal levels	68
6.3.5	Additional reference interference performance requirements and conditions.....	69

6.4	Erroneous frame indication performance	71
6.5	Random access and paging performance at high input levels	72
6.6	Frequency hopping performance under interference conditions	72
6.7	Incremental Redundancy Performance for EGPRS and EGPRS2 MS	72
Annex A (informative): Spectrum characteristics (spectrum due to the modulation)		158
Annex B (normative): Transmitted power level versus time		166
Annex C (normative): Propagation conditions.....		172
C.1	Simple wideband propagation model	172
C.2	Doppler spectrum types.....	172
C.3	Propagation models	173
C.3.1	Typical case for rural area (RAx): (6 tap setting).....	173
C.3.2	Typical case for hilly terrain (HTx): (12 tap setting).....	173
C.3.3	Typical case for urban area (TUx): (12 tap setting).....	174
C.3.4	Profile for equalization test (EQx): (6 tap setting)	174
C.3.5	Typical case for very small cells (Tix): (2 tap setting).....	174
Annex D (normative): Environmental conditions		175
D.1	General	175
D.2	Environmental requirements for the MSs.....	175
D.2.1	Temperature (GSM 400, GSM 900 and DCS 1 800)	175
D.2.1.1	Environmental Conditions (PCS 1 900, GSM 850 and GSM 700).....	175
D.2.2	Voltage	175
D.2.3	Vibration (GSM 400, GSM 900 and DCS 1 800)	176
D.2.3.1	Vibration (PCS 1 900, GSM 850 and GSM 700).....	176
D.3	Environmental requirements for the BSS equipment.....	176
D.3.1	Environmental requirements for the BSS equipment	177
Annex E (normative): Repeater characteristics		178
E.1	Introduction	178
E.2	Spurious emissions	178
E.3	Intermodulation products	179
E.4	Out of band gain.....	179
E.5	Frequency error and modulation accuracy	179
E.5.1	Frequency error	179
E.5.2	Modulation accuracy at GMSK modulation.....	180
E.5.3	Modulation accuracy at 8-PSK, 16-QAM, 32-QAM, QPSK and AQPSK modulation.....	180
Annex F (normative): Antenna Feeder Loss Compensator Characteristics (GSM 400, GSM 900 and DCS 1800).....		182
F.1	Introduction	182
F.2	Transmitting path	182
F.2.1	Maximum output power	182
F.2.2	Gain	183
F.2.3	Burst transmission characteristics	183
F.2.4	Phase error.....	183
F.2.5	Frequency error	184
F.2.6	Group delay	184
F.2.7	Spurious emissions	184
F.2.8	VSWR	185
F.2.9	Stability	185
F.3	Receiving path.....	185

F.3.1	Gain	185
F.3.2	Noise figure	185
F.3.3	Group delay	185
F.3.4	Intermodulation performance	185
F.3.5	VSWR	185
F.3.6	Stability	185
F.4	Guidelines (informative)	185
Annex G (normative): Calculation of Error Vector Magnitude		187
Annex H (normative): Requirements on Location Measurement Unit		189
H.1	TOA LMU Requirements	189
H.1.1	Void	189
H.1.2	LMU characteristics	189
H.1.2.1	Blocking characteristics	189
H.1.2.2	AM suppression characteristics	189
H.1.2.3	Intermodulation characteristics	190
H.1.2.4	Spurious emissions	190
H.1.3	Time-of-Arrival Measurement Performance	190
H.1.3.1	Sensitivity Performance	190
H.1.3.2	Interference Performance	191
H.1.3.3	Multipath Performance	192
H.1.4	Radio Interface Timing Measurement Performance	192
H.2	E-OTD LMU Requirements	192
H.2.1	LMU Characteristics	192
H.2.1.1	Blocking characteristics	193
H.2.1.2	AM suppression characteristics	193
H.2.1.3	Intermodulation characteristics	193
H.2.2	Sensitivity and Interference Performance	193
H.2.2.1	Sensitivity Performance	193
H.2.2.2	Interference Performance	194
H.2.2.3	Multipath Performance	194
Annex I (normative): E-OTD Mobile Station Requirements		196
I.1	Introduction	196
I.2	Sensitivity and Interference Performance	196
I.2.1	Sensitivity Performance	196
I.2.2	Interference Performance	197
I.2.3	Multipath Performance	197
Annex J (informative): Guidance on the Usage of Dynamic ARFCN Mapping		198
J.1	Introduction	198
J.2	Dynamic allocation of GSM 400, GSM 800, GSM 900, DCS 1800 and PCS 1900 ARFCNs	198
J.3	Controlling changes in dynamic mapping	198
Annex K (normative): Reference TFCs for FLO		200
Annex L (normative): Reference Test Scenarios for DARP		202
Annex M (normative): Minimum Performance Requirements for Assisted Global Positioning System (A-GPS)		204
M.1	General	204
M.1.1	Abbreviations	204
M.1.2	Measurement parameters	204
M.1.2.1	MS based A-GPS measurement parameters	204
M.1.2.2	MS assisted A-GPS measurement parameters	204
M.1.3	Response time	204

M.1.4	Time assistance	204
M.1.4.1	Use of fine time assistance.....	205
M.1.4.2	2D position error.....	205
M.2	A-GPS minimum performance requirements.....	205
M.2.1	Sensitivity.....	205
M.2.1.1	Coarse time assistance	205
M.2.1.1.1	Minimum Requirements (Coarse time assistance).....	206
M.2.1.2	Fine time assistance	206
M.2.1.2.1	Minimum Requirements (Fine time assistance).....	206
M.2.2	Nominal Accuracy.....	206
M.2.2.1	Minimum requirements (nominal accuracy).....	207
M.2.3	Dynamic Range.....	207
M.2.3.1	Minimum requirements (dynamic range)	207
M.2.4	Multi-Path scenario	207
M.2.4.1	Minimum Requirements (multi-path scenario).....	208
M.2.5	Moving scenario and periodic location	208
M.2.5.1	Minimum Requirements (moving scenario and periodic location).....	209
M.3	Test conditions	209
M.3.1	General	209
M.3.1.1	Parameter values.....	209
M.3.1.2	Time assistance.....	210
M.3.1.3	GPS Reference Time	210
M.3.1.4	Reference and MS locations	210
M.3.1.5	Satellite constellation and assistance data.....	210
M.3.1.6	Atmospheric delays.....	210
M.3.1.7	GSM Frequency and frequency error.....	211
M.3.1.8	Information elements	211
M.3.1.9	GPS signals.....	211
M.3.1.10	RESET MS POSITIONING STORED INFORMATION Message	211
M.4	Propagation Conditions	211
M.4.1	Static propagation conditions	211
M.4.2	Multi-path Case G1	211
M.5	Measurement sequence chart.....	212
M.5.1	General	212
M.5.2	MS Based A-GPS Measurement Sequence Chart	212
M.5.3	MS Assisted A-GPS Measurement Sequence Chart	213
M.6	Assistance data required for testing.....	214
M.6.1	Introduction	214
M.6.2	Information elements required for MS-based.....	214
M.6.3	Information elements available for MS-assisted	215
M.7	Converting MS-assisted measurement reports into position estimates	217
M.7.1	Introduction	217
M.7.2	MS measurement reports.....	217
M.7.3	Weighted Least Squares (WLS) position solution.....	218
Annex N (normative): Reference Test Scenarios for DARP Phase II (MSRD).....		220
N.1	Interferer configurations	220
N.2	Correlation and antenna gain imbalance.....	221
N.3	Testing MSRD terminal conformance to legacy requirements.....	222
Annex O (normative): Minimum Performance Requirements for Assisted Galileo and Additional Navigation Satellite Systems (A-GANSS).....		224
O.1	General	224
O.1.1	Abbreviations	224
O.1.2	Measurement parameters.....	224
O.1.2.1	MS based A-GANSS measurement parameters.....	224

O.1.2.2	MS assisted A-GANSS measurement parameters	224
O.1.3	Response time	224
O.1.4	Time assistance	225
O.1.4.1	Use of fine time assistance.....	225
O.1.5	Error definitions	225
O.2	A-GANSS minimum performance requirements	226
O.2.1	Sensitivity.....	226
O.2.1.1	Coarse time assistance	226
O.2.1.1.1	Minimum Requirements (Coarse time assistance).....	227
O.2.1.2	Fine time assistance	227
O.2.1.2.1	Minimum Requirements (Fine time assistance).....	227
O.2.2	Nominal Accuracy.....	228
O.2.2.1	Minimum requirements (nominal accuracy)	228
O.2.3	Dynamic Range	229
O.2.3.1	Minimum requirements (dynamic range)	229
O.2.4	Multi-Path scenario	229
O.2.4.1	Minimum Requirements (multi-path scenario).....	230
O.2.5	Moving scenario and periodic location	230
O.2.5.1	Minimum Requirements (moving scenario and periodic location).....	231
O.3	Test conditions	232
O.3.1	General	232
O.3.1.1	Parameter values	232
O.3.1.2	Time assistance	232
O.3.1.3	GANSS Reference Time.....	232
O.3.1.4	Reference and MS locations	232
O.3.1.5	Satellite constellation and assistance data.....	233
O.3.1.6	Atmospheric delays.....	233
O.3.1.7	Sensors	233
O.3.1.8	Information elements	233
O.3.1.9	GNSS signals	233
O.3.1.10	RESET MS POSITIONING STORED INFORMATION Message	233
O.3.2	GNSS System Time Offsets	234
O.4	Propagation Conditions	234
O.4.1	Static propagation conditions	234
O.4.2	Multi-path case	234
O.7.1	Introduction	239
O.7.2	MS measurement reports.....	239
O.7.3	Weighted Least Squares (WLS) position solution.....	241
Annex P (normative): Minimum receiver performance requirements for MSR BS.....		243
P.1	Reference Sensitivity and interference performance.....	243
P.2	Other receiver characteristics	243
P.2.1	Blocking characteristics	243
P.2.2	Intermodulation characteristics	243
P.2.3	AM suppression.....	244
Annex Q(normative): Reference Test Scenarios for Voice services over Adaptive Multi-user channels on One Slot (VAMOS).....		245
Q.1	Interferer configurations in downlink	245
Q.2	Interferer configurations in uplink.....	246
Q.3	Sensitivity test configuration in downlink	247
Q.4	Sensitivity test configuration in uplink.....	247
Q.5	Time and frequency offset in uplink.....	247
Q.6	VAMOS DTX scenario in downlink	247

Annex R (informative): **Change history**249
History258

Foreword

This Technical Specification has been produced by the 3rd Generation Partnership Project (3GPP).

The contents of the present document are subject to continuing work within the TSG and may change following formal TSG approval. Should the TSG modify the contents of the present document, it will be re-released by the TSG with an identifying change of release date and an increase in version number as follows:

Version x.y.z

where:

- x the first digit:
 - 1 presented to TSG for information;
 - 2 presented to TSG for approval;
 - 3 or greater indicates TSG approved document under change control.
- y the second digit is incremented for all changes of substance, i.e. technical enhancements, corrections, updates, etc.
- z the third digit is incremented when editorial only changes have been incorporated in the document.

1 Scope

The present document defines the requirements for the transceiver of the pan-European digital cellular telecommunications systems GSM.

Requirements are defined for two categories of parameters:

- those that are required to provide compatibility between the radio channels, connected either to separate or common antennas, that are used in the system. This category also includes parameters providing compatibility with existing systems in the same or adjacent frequency bands;
- those that define the transmission quality of the system.

The present document defines RF characteristics for the Mobile Station (MS) and Base Station System (BSS). The BSS will contain Base Transceiver Stations (BTS), which can be normal BTS, micro-BTS or pico-BTS. The precise measurement methods are specified in 3GPP TS 51.010 and 3GPP TS 51.021.

Unless otherwise stated, the requirements defined in this EN apply to the full range of environmental conditions specified for the equipment (see annex D).

In the present document some relaxations are introduced for GSM 400 MSs, GSM 900 MSs, GSM 700 MSs and GSM 850 MSs which pertain to power class 4 or 5 (see subclause 4.1.1). In the present document these Mobile Stations are referred to as "small MS".

MSs may operate on more than one of the frequency bands specified in clause 2. These MSs are referred to as "Multi band MSs" in this EN. Multi band MSs shall meet all requirements for each of the bands supported. The relaxation on GSM 400 MSs, GSM 900 MSs, GSM 700 MSs and GSM 850 MSs for a "small MS" are also valid for a multi band MS if it complies with the definition of a small MS.

The RF characteristics of repeaters are defined in annex E of this EN. Annexes D and E are the only clauses of this EN applicable to repeaters. Annex E does not apply to the MS or BSS. The precise measurement methods for repeaters are specified in 3GPP TS 51.026 [35].

The present document also includes specification information for mixed mode operation at 850 MHz and 1900 MHz. (MXM 850 and MXM 1900). 850 MHz and 1900 MHz mixed-mode is defined as a network that deploys both 30 kHz RF carriers and 200 kHz RF carriers in geographic regions where the Federal Communications Commission (FCC) regulations are applied or adopted.

The requirements for a MS in a mixed-mode system, MXM 850 and MXM 1900, correspond to the requirements for GSM 850 MS and PCS 1900 MS respectively.

Annex M defines the minimum performance requirements for A-GPS for MSs that support A-GPS. Annex M does not apply to the BSS.

The present document also includes specific requirements for a multicarrier BTS class, wherever explicitly stated in the text. All other requirements designated for BTS and normal BTS apply if not otherwise stated. The multicarrier BTS class has relaxed requirements in the areas of Tx spurious emissions, intermodulation attenuation and, when multicarrier receiver is included, Rx blocking. Usage of multicarrier BTSs in some geographical regions might be subject to regulatory restrictions to protect other radio systems operating in bands of adjacent frequency assignments, in particular for all safety related applications like railway applications. In areas where such systems coexist with multicarrier BTSs, the received interference power originating from multicarrier BTSs might have to be limited.

The document also includes entry points in some tables for the multicarrier BTS requirements to which TS 37.104 [33] for Multi-Standard Radio Base Stations (MSR BS) is referring to as specific GSM/EDGE single-RAT requirements not covered by the general requirements. These entry points are marked with ^{M)} and, as described in a note in each applicable table, identify the relevant column(s) that are applicable as MSR BS requirements. In general the requirements for multicarrier BTS equipped with multicarrier receiver also apply to Multi-Standard Radio Base Stations. The GSM requirements for Multi-Standard Radio Base Stations are defined for GSM 850, GSM 900, DCS 1800 and PCS 1900 only. Requirements for other frequency bands and MXM base stations are excluded. Annex P defines the minimum performance for the receiver in MSR BS.

For equipment not declared as MSR BS the ^{M)} indications can be ignored.

1.1 References

The following documents contain provisions which, through reference in this text, constitute provisions of the present document.

- References are either specific (identified by date of publication, edition number, version number, etc.) or non-specific.
- For a specific reference, subsequent revisions do not apply.
- For a non-specific reference, the latest version applies. In the case of a reference to a 3GPP document (including a GSM document), a non-specific reference implicitly refers to the latest version of that document *in the same Release as the present document*.

- [1] 3GPP TR 21.905: 'Vocabulary for 3GPP Specifications'.
- [1A] 3GPP TS 25.144: 'User Equipment (UE) and Mobile Station (MS) Over the Air Performance Requirements'.
- [1B] 3GPP TS 34.114: 'User Equipment (UE) / Mobile Station (MS) Over The Air (OTA) antenna performance; Conformance testing'.
- [2] 3GPP TR 43.030: 'Radio network planning aspects'.
- [3] 3GPP TS 43.052: 'GSM Cordless Telephony System (CTS); Lower layers of the CTS radio interface; Stage 2'.
- [4] 3GPP TS 43.059: 'Functional Stage 2 description of Location Services in GERAN'.
- [5] 3GPP TS 43.064: 'General Packet Radio Service (GPRS); GPRS Radio Interface Stage 2'.
- [6] 3GPP TS 44.014: 'Individual equipment type requirements and interworking; Special conformance testing functions'.
- [7] 3GPP TS 44.018: 'Mobile radio interface layer 3 specification; Radio Resource Control Protocol'.
- [7A] 3GPP TS 44.031: 'Mobile Station (MS) - Serving Mobile Location Centre (SMLC) Radio Resource LCS Protocol (RRLP)'.
- [8] 3GPP TS 44.071: 'Mobile radio interface layer 3 Location Services (LCS) specification'.
- [9] 3GPP TS 45.001: 'Physical layer on the radio path General description'.
- [10] 3GPP TS 45.002: 'Multiplexing and multiple access on the radio path'.
- [11] 3GPP TS 45.003: 'Channel coding'.
- [12] 3GPP TS 45.004: 'Modulation'.
- [13] 3GPP TS 45.008: 'Radio subsystem link control'.
- [14] 3GPP TS 45.010: 'Radio subsystem synchronization'.
- [15] 3GPP TS 45.050: 'Background for Radio Frequency (RF) requirements'.
- [16] 3GPP TS 51.010: 'Mobile Station (MS) conformity specification'.
- [17] 3GPP TS 51.011: 'Specification of the Subscriber Identity Module - Mobile Equipment (SIM - ME) interface'.
- [18] 3GPP TS 51.021: 'Base Station System (BSS) equipment specification; Radio aspects'.
- [19] ITU-T Recommendation O.153: 'Basic parameters for the measurement of error performance at bit rates below the primary rate'.

- [20] ETSI EN 300 019-1-3: 'Equipment Engineering (EE); Environmental conditions and environmental tests for telecommunications equipment; Part 1-3: Classification of environmental conditions Stationary use at weather protected locations'.
- [21] ETSI EN 300 019-1-4: 'Equipment Engineering (EE); Environmental conditions and environmental tests for telecommunications equipment; Part 1-4: Classification of environmental conditions Stationary use at non-weather protected locations'.
- [22] FCC Title 47 CFR Part 24: 'Personal Communication Services', Subpart E "Broadband services'.
- [23] ITU-T Recommendation O.151 (1992): 'Error performance measuring equipment operating at the primary rate and above'.
- [24] TIA/EIA-136-C: 'TDMA Third Generation Wireless'.
- [25] IEC publication 68-2-1: 'Environmental Testing; Part 2; Tests – Test A: Cold'.
- [26] IEC publication 68-2-2: 'Basic Environmental Testing Procedures; Part 2; Tests - Tests B: Dry heat'.
- [27] IEC publication 68-2-36: 'Basic Environmental Testing Procedures; Part 2: Tests; Test Fdb: Random vibration wide band – Reproducibility Medium'.
- [28] FCC Title 47 CFR Part 22: 'Public Mobile Services'.
- [29] FCC Title 47 CFR Part 27: 'Miscellaneous Wireless Services'. Subpart C 'Technical Standards'.
- [30] ICD-GPS 200, Navstar GPS Space Segment/Navigation User Interfaces, Rev. C.
- [31] P. Axelrad, R.G. Brown, "GPS Navigation Algorithms", in Chapter 9 of "Global Positioning System: Theory and Applications", Volume 1, B.W. Parkinson, J.J. Spilker (Ed.), Am. Inst. of Aeronautics and Astronautics Inc., 1996.
- [32] S.K. Gupta, "Test and Evaluation Procedures for the GPS User Equipment", ION-GPS Red Book, Volume 1, p. 119.
- [33] 3GPP TS 37.104: 'Multi-Standard (MSR) Base Station (BS) radio transmission and reception'.
- [34] ITU-R SM.329: 'Unwanted emissions in the spurious domain'.
- [35] 3GPP TS 51.026: 'Base Station System (BSS) equipment specification; Part 4: Repeaters'.

1.2 Abbreviations

Abbreviations used in the present document are listed in 3GPP TR 21.905.

In addition to abbreviations in 3GPP TR 21.905, the following abbreviations are applied:

SCPIR	Sub Channel Power Imbalance Ratio (see 3GPP TS 45.004)
SCPIR_DL	Sub Channel Power Imbalance Ratio on DownLink
SCPIR_UL	Sub Channel Power Imbalance Ratio on UpLink

1.3 Definitions

For the purposes of the present document, the following terms and definitions apply.

Subchannel power imbalance ratio on downlink: in the downlink, the subchannel power imbalance ratio is the SCPIR as defined in 3GPP TS 45.004.

NOTE: Information bits of *VAMOS subchannel 2* and *VAMOS subchannel 1* respectively modulate the quadrature component and inphase component of the AQPSK symbols (see 3GPP TS 45.002).

Subchannel power imbalance ratio on uplink: the ratio of the average received uplink power of *VAMOS subchannel 2* (P_{u2}) to the average received uplink power of *VAMOS subchannel 1* (P_{u1}) expressed as $10 \cdot \log_{10}(P_{u2}/P_{u1})$ dB.

VAMOS I/II MS: Mobile Station supporting VAMOS level I/II respectively (see 3GPP TS 24.008).

Minimum carrier frequency spacing: minimum spacing between the centre frequencies of simultaneously transmitted or received GSM carriers of a BTS belonging to the multicarrier BTS class.

2 Frequency bands and channel arrangement

i) T-GSM 380 band:

- for T-GSM 380, the system is required to operate in the following band:
 - 380,2 MHz to 389,8 MHz: mobile transmit, base receive;
 - 390,2 MHz to 399,8 MHz base transmit, mobile receive.

ii) T-GSM 410 band:

- for T-GSM 410, the system is required to operate in the following band:
 - 410,2 MHz to 419,8 MHz: mobile transmit, base receive;
 - 420,2 MHz to 429,8 MHz base transmit, mobile receive.

iii) GSM 450 Band:

- for GSM 450, the system is required to operate in the following band:
 - 450,4 MHz to 457,6 MHz: mobile transmit, base receive;
 - 460,4 MHz to 467,6 MHz base transmit, mobile receive.

iv) GSM 480 Band;

- for GSM 480, the system is required to operate in the following band:
 - 478,8 MHz to 486 MHz: mobile transmit, base receive;
 - 488,8 MHz to 496 MHz base transmit, mobile receive.

v) GSM 710 Band:

- for GSM 710, the system is required to operate in the following band:
 - 698 MHz to 716 MHz: mobile transmit, base receive;
 - 728 MHz to 746 MHz: base transmit, mobile receive.

vi) GSM 750 Band:

- for GSM 750, the system is required to operate in the following band:
 - 747 MHz to 763 MHz: base transmit, mobile receive;
 - 777 MHz to 793 MHz: mobile transmit, base receive.

vii) T-GSM 810 Band:

- for T-GSM 810, the system is required to operate in the following band:
 - 806 MHz to 821 MHz: mobile transmit, base receive;
 - 851 MHz to 866 MHz: base transmit, mobile receive.

viii) GSM 850 Band:

- for GSM 850, the system is required to operate in the following band:

- 824 MHz to 849 MHz: mobile transmit, base receive;
- 869 MHz to 894 MHz: base transmit, mobile receive.

ix) Standard or primary GSM 900 Band, P-GSM:

- for Standard GSM 900 band, the system is required to operate in the following frequency band:
 - 890 MHz to 915 MHz: mobile transmit, base receive;
 - 935 MHz to 960 MHz: base transmit, mobile receive.

x) Extended GSM 900 Band, E-GSM (includes Standard GSM 900 band):

- for Extended GSM 900 band, the system is required to operate in the following frequency band:
 - 880 MHz to 915 MHz: mobile transmit, base receive;
 - 925 MHz to 960 MHz: base transmit, mobile receive.

xi) Railways GSM 900 Band, R-GSM (includes Standard and Extended GSM 900 Band);

- for Railways GSM 900 band, the system is required to operate in the following frequency band:
 - 876 MHz to 915 MHz: mobile transmit, base receive;
 - 921 MHz to 960 MHz: base transmit, mobile receive.

xii) Void;

xiii) DCS 1 800 Band:

- for DCS 1 800, the system is required to operate in the following band:
 - 1 710 MHz to 1 785 MHz: mobile transmit, base receive;
 - 1 805 MHz to 1 880 MHz: base transmit, mobile receive.

xiv) PCS 1 900 Band:

- for PCS 1 900, the system is required to operate in the following band:
 - 1 850 MHz to 1 910 MHz: mobile transmit, base receive;
 - 1 930 MHz to 1 990 MHz base transmit, mobile receive.

NOTE 1: The term GSM 400 is used for any GSM system, which operates in any 400 MHz band, including T-GSM 380.

NOTE 2: The term GSM 700 is used for any GSM system, which operates in any 700 MHz band.

NOTE 3: The term GSM 850 is used for any GSM system which operates in any 850 MHz band but excluding T-GSM 810.

NOTE 4: The term GSM 900 is used for any GSM system, which operates in any 900 MHz band.

NOTE 5: The BTS may cover a complete band, or the BTS capabilities may be restricted to a subset only, depending on the operator needs.

For T-GSM 810 the requirements for GSM 900 shall apply, apart for those parameters for which a separate requirement exists.

Operators may implement networks that operates on a combination of the frequency bands above to support multi band mobile terminals.

The channel spacing is 200 kHz.

The carrier frequency is designated by the absolute radio frequency channel number (ARFCN). If we call $F_l(n)$ the frequency value of the carrier ARFCN n in the lower band, and $F_u(n)$ the corresponding frequency value in the upper band, we have for the dynamically mapped ARFCNs:

Table 2-1 Dynamically mapped ARFCN

T-GSM 380	$F_l(n) = 380.2 + 0.2*(n-x+y)$	$x \leq n \leq x+z$	$F_u(n) = F_l(n) + 10$
T-GSM 410	$F_l(n) = 410.2 + 0.2*(n-x+y)$	$x \leq n \leq x+z$	$F_u(n) = F_l(n) + 10$
T-GSM 810	$F_l(n) = 806.2 + 0.2*(n-x+y)$	$x \leq n \leq x+z$	$F_u(n) = F_l(n) + 45$
GSM 710	$F_l(n) = 698.2 + 0.2*(n-x+y)$	$x \leq n \leq x+z$	$F_u(n) = F_l(n) + 30$
GSM 750	$F_l(n) = 747.2 + 0.2*(n-x+y)$	$x \leq n \leq x+z$	$F_u(n) = F_l(n) + 30$
DCS 1 800	$F_l(n) = 1710.2 + 0.2*(n-x+y)$	$x \leq n \leq x+z$	$F_u(n) = F_l(n) + 95$
PCS 1 900	$F_l(n) = 1850.2 + 0.2*(n-x+y)$	$x \leq n \leq x+z$	$F_u(n) = F_l(n) + 80$

where the applicable band is indicated by the GSM_Band parameter, $x = \text{ARFCN_FIRST}$, $y = \text{BAND_OFFSET}$ and $z = \text{ARFCN_RANGE}$ (See 3GPP TS 44.018). Parameters defining carrier frequencies not belonging to the indicated band shall not be considered erroneous.

Information about dynamic mapping is provided by System Information type 15 or Packet System Information type 8 if PBCCH exists, and optionally by System Information type 14. Dynamic ARFCN mapping shall be valid for the whole PLMN. Dynamic mapping has priority over the fixed designation of carrier frequencies. The support of dynamic ARFCN mapping is optional for all other mobile stations except those supporting GSM 700 and T-GSM.

$F_l(n)$ and $F_u(n)$ for all other ARFCNs:

Table 2-2 Fixed designation of ARFCN

P-GSM 900	$F_l(n) = 890 + 0.2*n$	$1 \leq n \leq 124$	$F_u(n) = F_l(n) + 45$
E-GSM 900	$F_l(n) = 890 + 0.2*n$ $F_l(n) = 890 + 0.2*(n-1024)$	$0 \leq n \leq 124$ $975 \leq n \leq 1023$	$F_u(n) = F_l(n) + 45$
R-GSM 900	$F_l(n) = 890 + 0.2*n$ $F_l(n) = 890 + 0.2*(n-1024)$	$0 \leq n \leq 124$ $955 \leq n \leq 1023$	$F_u(n) = F_l(n) + 45$
DCS 1 800	$F_l(n) = 1710.2 + 0.2*(n-512)$	$512 \leq n \leq 885$	$F_u(n) = F_l(n) + 95$
PCS 1 900	$F_l(n) = 1850.2 + 0.2*(n-512)$	$512 \leq n \leq 810$	$F_u(n) = F_l(n) + 80$
GSM 450	$F_l(n) = 450.6 + 0.2*(n-259)$	$259 \leq n \leq 293$	$F_u(n) = F_l(n) + 10$
GSM 480	$F_l(n) = 479 + 0.2*(n-306)$	$306 \leq n \leq 340$	$F_u(n) = F_l(n) + 10$
GSM 850	$F_l(n) = 824.2 + 0.2*(n-128)$	$128 \leq n \leq 251$	$F_u(n) = F_l(n) + 45$

Frequencies are in MHz.

A multi-band MS shall interpret ARFCN numbers 512 to 810 as either DCS 1800 or PCS 1900 frequencies according to the parameter BAND_INDICATOR when received in other than the DCS 1800 or PCS 1900 bands. If received in the DCS 1800 or PCS 1900 bands, those ARFCN numbers shall be interpreted as frequencies in the same band. The BAND_INDICATOR is broadcast on BCCH, PBCCH and SACCH. The most recently received value shall be applied by the mobile station. If the parameter is not broadcast, the default value is DCS 1800 frequencies.

3 Reference configuration

The reference configuration for the radio subsystem is described in 3GPP TS 45.001.

The micro-BTS is different from a normal BTS in two ways. Firstly, the range requirements are much reduced whilst the close proximity requirements are more stringent. Secondly, the micro-BTS is required to be small and cheap to allow external street deployment in large numbers. Because of these differences the micro-BTS needs a different set of RF parameters to be specified. Where the RF parameters are not different for the micro-BTS the normal BTS parameters shall apply.

The pico-BTS is an extension of the micro-BTS concept to the indoor environments. The very low delay spread, low speed, and small cell sizes give rise to a need for a different set of RF parameters to be specified.

Multicarrier BTS is a class of BTS, characterized by the ability to, in addition to single carrier operation, process two or more carriers in common active RF components simultaneously, either in multicarrier transmitter only or, in both

multicarrier transmitter and multicarrier receiver. The requirements for normal BTS applies to all multicarrier BTS unless otherwise stated in this specification.

The vendor shall declare if the multicarrier BTS supports non-contiguous frequency allocation, defined as an allocation where two groups of frequencies are separated with at least 5.4 MHz carrier separation between the innermost carriers. The term maximum Base Station RF bandwidth defines the maximum RF bandwidth in which a multicarrier BTS either transmits or transmits and receives multiple carriers simultaneously.

4 Transmitter characteristics

Throughout this clause, unless otherwise stated, requirements are given in terms of power levels at the antenna connector of the equipment. For equipment with integral antenna only, a reference antenna with 0 dBi gain shall be assumed.

For GMSK modulation, the term output power refers to the measure of the power when averaged over the useful part of the burst (see annex B).

For QPSK, AQPSK, 8-PSK, 16-QAM and 32-QAM modulation, the term output power refers to a measure that, with sufficient accuracy, is equivalent to the long term average of the power when taken over the useful part of the burst as specified in 3GPP TS 45.002 with any fixed TSC and with random encrypted bits.

The term peak hold refers to a measurement where the maximum is taken over a sufficient time that the level would not significantly increase if the holding time were longer.

NOTE: From a system perspective the over the air antenna performance is relevant. To determine the MS over the air performance the Total Radiated Power has been defined. Its definition can be found in 3GPP TS 25.144, and a test method is specified in 3GPP TS 34.114.

4.1 Output power

4.1.1 Mobile Station

The MS maximum output power and lowest power control level shall be, according to its class, as defined in the following tables.

i) MS maximum output power

Table 4.1-1 MS maximum power at GMSK modulation

Power class	GSM 400 & GSM 900 & GSM 850 & GSM 700 Nominal Maximum output power	DCS 1 800 Nominal Maximum output power	PCS 1 900 Nominal Maximum output power	Tolerance (dB) for conditions	
				normal	extreme
1	-----	1 W (30 dBm)	1 W (30 dBm)	±2	±2,5
2	8 W (39 dBm)	0,25 W (24 dBm)	0,25 W (24 dBm)	±2	±2,5
3	5 W (37 dBm)	4 W (36 dBm)	2 W (33 dBm)	±2	±2,5
4	2 W (33 dBm)			±2	±2,5
5	0,8 W (29 dBm)			±2	±2,5

Table 4.1-2 MS maximum power at other modulations

Power class	GSM 400 and GSM 900 & GSM 850 & GSM 700 Nominal Maximum output Power	GSM 400 and GSM 900 & GSM 850 & GSM 700 Tolerance (dB) for conditions		DCS 1 800 Nominal Maximum output power	PCS 1 900 Nominal Maximum output power	DCS 1 800 & PCS 1 900 Tolerance (dB) for conditions	
		normal	extreme			Power	Power
E1	33 dBm	±2	±2,5	30 dBm	30 dBm	±2	±2,5
E2	27 dBm	±3	±4	26 dBm	26 dBm	-4/+3	-4,5/+4
E3	23 dBm	±3	±4	22 dBm	22 dBm	±3	±4

The maximum power for power class E1-E3 is corrected for the different modulations according to the table below

Table 4.1-3 Correction factor of maximum power for different modulations in table 4.1-2

Modulation	Correction factor (dB)
QPSK	0
8-PSK	0
16-QAM	-2
32-QAM	-2

NOTE: In the case and only in the case of EGPRS2-B with the spectrally wide pulse shaping filter and the tight spectrum requirement at 400 kHz offset from the carrier (see section 4.2.1), the actual maximum output power may be up to 2 dB lower than the lower limit of the maximum output power's tolerance range defined by the power class table above and the correction factors of this table. In this case and only in this case, the MS need not use the highest power control level or the two highest power control levels for the respective modulation.

Maximum output power for GMSK in any one band shall always be equal to or higher than maximum output power for all other modulations for the same equipment in the same band.

A multi band MS has a combination of the power class in each band of operation from the table above. Any combination may be used.

The PCS 1 900, including its actual antenna gain, shall not exceed a maximum of 2 Watts (+33 dBm) EIRP per the applicable FCC rules for wideband PCS services [FCC Part 24, Subpart E, Section 24.232]. Power Class 3 is restricted to transportable or vehicular mounted units.

For GSM 850 MS, including its actual antenna gain, shall not exceed a maximum of 7 Watts (+38,5 dBm) ERP per the applicable FCC rules for public mobile services. [FCC Part 22, Subpart H, Section 22.913]

For GSM 700 MS, including its actual antenna gain, shall not exceed a maximum of 3 Watts (+35 dBm) ERP for handheld devices and maximum of 30 Watts (+45 dBm) ERP for other mobile devices per the applicable FCC rules. [FCC Part 27, Subpart C, Section 27.50].

ii) The different power control levels needed for adaptive power control (see 3GPP TS 45.008) shall have the nominal output power as defined in the tables below, starting from the power control level for the lowest nominal output power up to the power control level for the maximum nominal output power corresponding to the class of the particular MS as defined in the tables above. Whenever a power control level commands the MS to use a nominal output power equal to or greater than the maximum nominal output power for the power class of the MS, the nominal output power transmitted shall be the maximum nominal output power for the MS class, and the tolerance specified for that class (see tables 4.1-1, 4.1-2 and 4.1-3 above) shall apply.

Table 4.1-4a MS power control levels

GSM 400, GSM 900, GSM 850 and GSM 700

Power control level	Nominal Output power (dBm)	Tolerance (dB) for conditions	
		normal	extreme
0-2	39	±2	±2,5
3	37	±3	±4
4	35	±3	±4
5	33	±3	±4
6	31	±3	±4
7	29	±3	±4
8	27	±3	±4
9	25	±3	±4
10	23	±3	±4
11	21	±3	±4
12	19	±3	±4
13	17	±3	±4
14	15	±3	±4
15	13	±3	±4
16	11	±5	±6
17	9	±5	±6
18	7	±5	±6
19-31	5	±5	±6

Table 4.1-4b MS power control levels

DCS 1 800

Power control level	Nominal Output power (dBm)	Tolerance (dB) for conditions	
		normal	extreme
29	36	±2	±2,5
30	34	±3	±4
31	32	±3	±4
0	30	±3	±4
1	28	±3	±4
2	26	±3	±4
3	24	±3	±4
4	22	±3	±4
5	20	±3	±4
6	18	±3	±4
7	16	±3	±4
8	14	±3	±4
9	12	±4	±5
10	10	±4	±5
11	8	±4	±5
12	6	±4	±5
13	4	±4	±5
14	2	±5	±6
15-28	0	±5	±6

NOTE 1: For DCS 1 800, the power control levels 29, 30 and 31 are not used when transmitting the parameter MS_TXPWR_MAX_CCH on BCCH, for cross phase compatibility reasons. If levels greater than 30 dBm are required from the MS during a random access attempt, then these shall be decoded from parameters broadcast on the BCCH as described in 3GPP TS 45.008.

Furthermore, the difference in output power actually transmitted by the MS between two power control levels where the difference in nominal output power indicates an increase of 2 dB (taking into account the restrictions due to power class), shall be $+2 \pm 1,5$ dB. Similarly, if the difference in output power actually transmitted by the MS between two power control levels where the difference in nominal output power indicates a decrease of 2 dB (taking into account the restrictions due to power class), shall be $-2 \pm 1,5$ dB.

NOTE 2: A 2 dB nominal difference in output power can exist for non-adjacent power control levels e.g. power control levels 18 and 22 for GSM 400 and GSM 900; power control levels 31 and 0 for class 3 DCS 1 800 and power control levels 3 and 6 for class 4 GSM 400 and GSM 900.

A change from any power control level to any power control level may be required by the base transmitter. The maximum time to execute this change is specified in 3GPP TS 45.008.

Table 4.1-4c MS power control levels

PCS 1 900

Power Control Level	Output Power (dBm)	Tolerance (dB) for conditions	
		Normal	Extreme
22-29	Reserved	Reserved	Reserved
30	33	±2 dB	±2,5 dB
31	32	±2 dB	±2,5 dB
0	30	±3 dB ¹	±4 dB ¹
1	28	±3 dB	±4 dB
2	26	±3 dB	±4 dB
3	24	±3 dB ¹	±4 dB ¹
4	22	±3 dB	±4 dB
5	20	±3 dB	±4 dB
6	18	±3 dB	±4 dB
7	16	±3 dB	±4 dB
8	14	±3 dB	±4 dB
9	12	±4 dB	±5 dB
10	10	±4 dB	±5 dB
11	8	±4 dB	±5 dB
12	6	±4 dB	±5 dB
13	4	±4 dB	±5 dB
14	2	±5 dB	±6 dB
15	0	±5 dB	±6 dB
16-21	Reserved	Reserved	Reserved

NOTE: Tolerance for MS Power Classes 1 and 2 is ±2 dB normal and ±2,5 dB extreme at Power Control Levels 0 and 3 respectively.

The output power actually transmitted by the MS at each of the power control levels shall form a monotonic sequence, and the interval between power steps shall be 2 dB ± 1,5 dB except for the step between power control levels 30 and 31 where the interval is 1 dB ± 1 dB.

The MS transmitter may be commanded by the BTS to change from any power control level to any other power control level. The maximum time to execute this change is specified in 3GPP TS 45.008.

For CTS transmission, the nominal maximum output power of the MS shall be restricted to:

- 11 dBm (0,015 W) in GSM 900 i.e. power control level 16;
- 12 dBm (0,016 W) in DCS 1 800 i.e. power control level 9.

iii) In order to manage mobile terminal heat dissipation resulting from transmission on multiple uplink timeslots, the mobile station may reduce its maximum output power by up to the following values:

Table 4.1-5 MS power reduction when transmitting on multiple uplink timeslots

Number of timeslots in uplink assignment	Permissible nominal reduction of maximum output power, (dB)
1	0
2	3,0
3	4,8
4	6,0
5	7,0
6	7,8
7	8,5
8	9,0

The actual supported maximum output power shall be in the range indicated by the parameters XXX_MULTISLOT_POWER_PROFILE (See 3GPP TS 24.008) for n assigned uplink timeslots:

$$a \leq \text{MS maximum output power} \leq \min(\text{MAX_PWR}, a + b)$$

Where:

$$a = \min(\text{MAX_PWR}, \text{MAX_PWR} + \text{XXX_MULTISLOT_POWER_PROFILE} - 10\log(n));$$

MAX_PWR equals to the MS maximum output power according to the relevant power class;

XXX_MULTISLOT_POWER_PROFILE refers either to GMSK_MULTISLOT_POWER PROFILE or 8-PSK_MULTISLOT_POWER_PROFILE depending on the modulation type concerned, and

XXX_MULTISLOT_POWER_PROFILE 0 = 0 dB;
 XXX_MULTISLOT_POWER_PROFILE 1 = 2 dB;
 XXX_MULTISLOT_POWER_PROFILE 2 = 4 dB;
 XXX_MULTISLOT_POWER_PROFILE 3 = 6 dB.

For DCS 1800 and PCS 1900 frequency bands b = 3 dB, for all other bands b = 2 dB.

For QPSK, 16-QAM and 32-QAM modulations 8-PSK_MULTISLOT_POWER_PROFILE shall apply, corrected for the difference in MAX_PWR for each modulation.

The supported maximum output power for each number of uplink timeslots shall form a monotonic sequence. The maximum reduction of maximum output power from an assignment of n uplink timeslots to an assignment of n+1 uplink timeslots shall be equal to the difference of maximum permissible nominal reduction of maximum output power for the corresponding number of timeslots, as defined in the table 4.1-5 above.

As an exception, in case of a multislot uplink assignment, the first power control step down from the maximum output power is allowed to be in the range 0...2 dB.

In case the MS transmits on more uplink slots than assigned (e.g. due to a polling response, see 3GPP TS 44.060), the MS may reduce uplink power as above for a multislot uplink configuration but as a function of the number of active uplink slots on a TDMA frame basis.

On a multislot uplink configuration the MS may restrict the interslot output power control range to a 10 dB window, on a TDMA frame basis. On those timeslots where the ordered power level is more than 10 dB lower than the applied power level of the highest power timeslot, the MS shall transmit at a lowest possible power level within 10 dB range from the highest applied power level, if not transmitting at the actual ordered power level.

4.1.2 Base station

a) Requirements for base stations except multicarrier BTS

For a normal BTS, the maximum output power measured at the input of the BSS Tx combiner, shall be, according to its class, as defined in the following table.

Table 4.1-6 Normal BTS power classes

GSM 400 & GSM 900 & GSM 850 & MXM 850 and GSM 700		DCS 1 800 & PCS 1 900 & MXM 1900	
TRX power class	Maximum output power	TRX power class	Maximum output power
1	320 - (< 640) W	1	20 - (< 40) W
2	160 - (< 320) W	2	10 - (< 20) W
3	80 - (< 160) W	3	5 - (< 10) W
4	40 - (< 80) W	4	2,5 - (< 5) W
5	20 - (< 40) W		
6	10 - (< 20) W		
7	5 - (< 10) W		
8	2,5 - (< 5) W		

For a micro-BTS or a pico-BTS, the maximum output power per carrier measured at the antenna connector after all stages of combining shall be, according to its class, defined in the following table.

Table 4.1-7 Micro BTS and Pico BTS power classes

GSM 900 & GSM 850 & MXM 850 and GSM 700 micro and pico-BTS		DCS 1 800 & PCS 1 900 & MXM 1900 micro and pico-BTS	
TRX power class	Maximum output power	TRX power class	Maximum output power
Micro		Micro	
M1	(> 19) - 24 dBm	M1	(> 27) - 32 dBm
M2	(> 14) - 19 dBm	M2	(> 22) - 27 dBm
M3	(> 9) - 14 dBm	M3	(> 17) - 22 dBm
Pico		Pico	
P1	(> 13) - 20 dBm	P1	(> 16) - 23 dBm

For BTS supporting QPSK, AQPSK, 8-PSK, 16-QAM and/or 32-QAM the manufacturer shall declare the maximum output power capability for GMSK and for each additionally supported combination of modulation and symbol rate.

The TRX power class is defined by the highest single carrier output power capability for any modulation.

b) Requirements for multicarrier BTS

For BTS belonging to the multicarrier BTS class, the manufacturer shall declare the maximum output power per carrier in case that all carriers are operated at the same nominal output power. The declaration shall be given for each modulation and for all supported number of carriers up to the maximum number on each antenna port. Additionally, the maximum total power supported shall be declared.

c) Requirements for all types of base stations

The tolerance of the actual maximum output power of the BTS for each supported modulation shall be ± 2 dB under normal conditions and $\pm 2,5$ dB under extreme conditions. Settings shall be provided to allow the output power to be reduced from the maximum level for the modulation with the highest output power capability in at least six steps of nominally 2 dB with an accuracy of ± 1 dB for each modulation to allow a fine adjustment of the coverage by the network operator. In addition, the actual absolute output power for each supported modulation at each static RF power step (N), with the exception below for the highest RF power level for 8-PSK, AQPSK, QPSK, 16-QAM and 32-QAM shall be $2 \cdot N$ dB below the absolute output power at static RF power step 0 for the modulation with the highest output power capability with a tolerance of ± 3 dB under normal conditions and ± 4 dB under extreme conditions. The static RF power step 0 shall be the actual output power according to the TRX power class.

As an option the BSS can utilize downlink RF power control. In addition to the static RF power steps described above, the BSS may then for each supported modulation utilize up to 15 steps of power control levels with a step size of $2 \text{ dB} \pm 1,5 \text{ dB}$, in addition the actual absolute output power for each supported modulation at each power control level (N), with the exception below for the highest power level for QPSK, AQPSK, 8-PSK, 16-QAM and 32-QAM, shall be $2 \cdot N$ dB below the absolute output power at power control level 0 for the modulation with the highest output power

capability with a tolerance of ± 3 dB under normal conditions and ± 4 dB under extreme conditions. The power control level 0 shall be the set output power according to the TRX power class and the six power settings defined above.

The output power for GMSK, QPSK, AQPSK, 8-PSK, 16-QAM and 32-QAM shall be nominally the same for any supported static RF power step and power control level. An exception is allowed for the maximum output power levels of respectively QPSK, AQPSK, 8-PSK, 16-QAM and 32-QAM which may be lower than the GMSK output power for the same power step or power control level. The nominal size of the first step down from the respective maximum power level of QPSK, AQPSK, 8-PSK, 16-QAM and 32-QAM may be in the range 0...2 dB. The output power for the GMSK, QPSK, AQPSK, 8-PSK, 16-QAM and 32-QAM at this power control level shall still be considered the same when required in 3GPP TS 45.008. The output power of QPSK, AQPSK, 8-PSK, 16-QAM and 32-QAM for the remaining power steps or power control levels shall be the same as the GMSK power for the corresponding power step or power control level within a tolerance of ± 1 dB. The number of static RF power steps and the total number of power control steps may be different for GMSK and other modulations.

Network operators or manufacturers may also specify the BTS output power including any Tx combiner, according to their needs.

4.1.2.1 Additional requirements for PCS 1 900 and MXM 1900 Base stations

The BTS transmitter maximum rated output power per carrier, measured at the input of the transmitter combiner, shall be, according to its TRX power class, as defined in the table 4.1-6 above. The base station output power may also be specified by the manufacturer or system operator at a different reference point (e.g. after transmitter combining).

The maximum radiated power from the BTS, including its antenna system, shall not exceed a maximum of 1 640 W EIRP, equivalent to 1 000 W ERP, per the applicable FCC rules for wideband PCS services [FCC part 24, subpart E, section 24.237].

4.1.2.2 Additional requirements for GSM 850 and MXM 850 Base stations

The BTS transmitter maximum rated output power per carrier, measured at the input of the transmitter combiner, shall be, according to its TRX power class, as defined in the table 4.1-6 above. The base station output power may also be specified by the manufacturer or system operator at a different reference point (e.g. after transmitter combining).

The maximum radiated power from the BTS, including its antenna system, shall not exceed a maximum of 500 W ERP, per the applicable FCC rules for public mobile services [FCC part 22, subpart H, section 22.913].

4.1.2.3 Additional requirements for GSM 700 Base stations

The BTS transmitter maximum rated output power per carrier, measured at the input of the transmitter combiner, shall be, according to its TRX power class, as defined in the table 4.1-6 above. The base station output power may also be specified by the manufacturer or system operator at a different reference point (e.g. after transmitter combining).

The maximum radiated power from the BTS, including its antenna system, shall not exceed a maximum 1000 W ERP for GSM 700 BTS per the applicable FCC rules [FCC Part 27, Subpart C, Section 27.50]

4.2 Output RF spectrum

The specifications contained in this subclause apply to both BTS and MS, in frequency hopping as well as in non frequency hopping mode, except that beyond 1800 kHz offset from the carrier the BTS is not tested in frequency hopping mode.

Due to the bursty nature of the signal, the output RF spectrum results from two effects:

- the modulation process;
- the power ramping up and down (switching transients).

The two effects are specified separately; the measurement method used to analyse separately those two effects is specified in 3GPP TS 51.010 and 3GPP TS 51.021. It is based on the "ringing effect" during the transients, and is a measurement in the time domain, at each point in frequency.

The limits specified thereunder are based on a 5-pole synchronously tuned measurement filter.

Unless otherwise stated, for the BTS, only one transmitter is active for the tests of this subclause.

4.2.1 Spectrum due to the modulation and wide band noise

4.2.1.1 General requirements for all types of Base stations and MS

The output RF modulation spectrum is specified in the tables in 4.2.1.3. A mask representation of this specification is shown in annex A. This specification applies for all RF channels supported by the equipment.

The specification applies to the entire of the relevant transmit band and up to 2 MHz either side.

The specification shall be met under the following measurement conditions:

- for BTS up to 1800 kHz from the carrier and for MS in all cases:
 - zero frequency scan, filter bandwidth and video bandwidth of 30 kHz up to 1800 kHz from the carrier and 100 kHz at 1800 kHz and above from the carrier, with averaging done over 50 % to 90 % of the useful part of the transmitted bursts, excluding the midamble, and then averaged over at least 200 such burst measurements. Above 1800 kHz from the carrier only measurements centred on 200 kHz multiples are taken with averaging over 50 bursts.
- for BTS at 1800 kHz and above from the carrier:
 - swept measurement with filter and video bandwidth of 100 kHz, minimum sweep time of 75 ms, averaging over 200 sweeps. All slots active, frequency hopping disabled.
- when tests are done in frequency hopping mode, the averaging shall include only bursts transmitted when the hopping carrier corresponds to the nominal carrier of the measurement. The specifications then apply to the measurement results for any of the hopping frequencies.

The figures in tables ax), bx) and cx) in 4.2.1.3, at the vertically listed power level (dBm) and at the horizontally listed frequency offset from the carrier (kHz), are then the maximum allowed level (dB) relative to a measurement in 30 kHz on the carrier.

NOTE: This approach of specification has been chosen for convenience and speed of testing. It does however require careful interpretation if there is a need to convert figures in the tables in subclause 4.2.1.3 into spectral density values, in that only part of the power of the carrier is used as the relative reference, and in addition different measurement bandwidths are applied at different offsets from the carrier. Appropriate conversion factors for this purpose are given in 3GPP TS 45.050.

For the BTS, the power level is the "actual absolute output power" defined in subclause 4.1.2. If the power level falls between two of the values in the tables in subclause 4.2.1.3, the requirement shall be determined by linear interpolation.

4.2.1.2 Additional requirements for multicarrier BTS

In case of the multicarrier BTS class, the requirements for spectrum due to modulation and wideband noise are based on the superposition of the single carrier spectrum requirements for all active carriers taking the different frequency offsets from each carrier into account. In addition to the measurements on a single carrier (4.2.1.1), the output spectrum shall be measured for frequency offsets between 400 kHz above the uppermost and below the lowermost carrier, respectively, and 10 MHz outside the transmit band with all carriers operating at full power at minimum carrier frequency spacing as well as with the carriers distributed across the declared maximum Base Station RF bandwidth as described in 3GPP TS 51.021 [18], specified for the BSS configuration under test. The following requirements apply:

- Depending on the active carrier number N , for frequency offsets higher than or equal to 1.8 MHz, the value of the spectrum due to modulation and wideband noise given for the measurement with single carrier may not increase by more than calculated from the expression $10 \cdot \log(N)$ dB, or fulfil the requirement according to the multicarrier BTS class in subclause 4.7.2, whichever less stringent.
- For frequency offsets less than 1.8 MHz, the unwanted emission must not exceed a mask defined by the cumulation of the spectrum due to modulation and wideband noise from each carrier as well as the possibly occurring IM products.
- In addition, a number of allowable exceptions are defined as stated in vi) and vii).

NOTE: This approach has been chosen to limit the wideband noise in the multicarrier operation by aligning with the performance of normal BTSs transmitting several carriers. These BTSs use combiner stages to feed the antenna which leads to a degradation of the noise performance at the antenna in the way as specified above. Above 1.8 MHz frequency offset a generic expression as stated above is applied. For a frequency offset below 1.8 MHz there is no corresponding simple generic expression as the spectrum will be dependent on the output power, carrier spacing as well as the number of active carriers.

In case of non-contiguous frequency allocation and a multicarrier BTS supporting non-contiguous frequency allocations as defined in clause 3, spectrum due to modulation and wideband noise shall be measured for frequency offsets above the uppermost carrier and frequency offsets below the lowermost carrier as specified above depending on the total number of active carriers N . In addition it shall be measured inbetween the two frequency groups with the first frequency group located at carrier frequency A and lower frequencies and a second frequency group located at carrier frequency B and higher frequencies, where the bandwidth $(B - A)$ specifies the bandwidth between the innermost carriers A and B . The following requirements apply for the range between the two frequency groups:

- Depending on the active carrier number N , for frequency offsets higher than or equal to 1.8 MHz both above the uppermost carrier A of the lower frequency group and below the lowermost carrier B of the upper frequency group the value of the spectrum due to modulation and wideband noise given for the measurement of the closest carrier of the innermost carriers A and B may not increase by more than calculated from the expression $10 \cdot \log(N)$ dB, or fulfil the requirement according to the multicarrier BTS class in subclause 4.7.2, whichever less stringent.
- For frequency offsets less than 1.8 MHz above the uppermost carrier A of the lower frequency group or below the lowermost carrier B of the upper frequency group, the unwanted emission must not exceed a mask defined by the cumulation of the spectrum due to modulation and wideband noise from each of the N carriers and the IM products.
- In addition, a number of allowable exceptions are defined as stated in vii) and viii).

4.2.1.3 Tables for spectrum requirements due to modulation and wideband noise

Two types of requirements are specified, depending on symbol-rate and pulse-shaping filter used:

Case 1: Normal symbol rate using linearised GMSK pulse-shaping filter and higher symbol rate using spectrally narrow pulse shaping filter

Case 2: Higher symbol rate using spectrally wide pulse shaping filter

For definition of pulse-shaping filters, see 3GPP TS 45.004.

The spectrally narrow pulse shaping filter in Case 1 and the spectrally wide pulse shaping filter in Case 2 are in this specification referred to as narrow and wide pulse shaping filter respectively.

- a1) GSM 400 and GSM 900 and GSM 850 and GSM 700 MS:

Case 1	Power level	100	200	250	400	≥ 600 < 1 800	≥ 1 800 < 3 000	≥ 3 000 < 6 000	≥ 6 000	
	≥ 39	+0,5	-30	-33	-60	-66	-69	-71	-77	
37	+0,5	-30	-33	-60	-64	-67	-69	-75		
35	+0,5	-30	-33	-60	-62	-65	-67	-73		
≤ 33	+0,5	-30	-33	-60*	-60	-63	-65	-71		

Case 2	Power level	[100]	[200]	[250]	[400]	[600]	≥ [800] < 1 800	≥ 1 800 < 3 000	≥ 3 000 < 6 000	≥ 6 000
	≥ 39	[+0,5]	[-12.3]	[-25]**	[-40]**	[-55]	[-60]	[-63]	[-65]	[-71]
37	[+0,5]	[-12.3]	[-25]**	[-40]**	[-55]	[-60]	[-63]	[-65]	[-71]	
35	[+0,5]	[-12.3]	[-25]**	[-40]**	[-55]	[-60]	[-63]	[-65]	[-71]	
≤ 33	[+0,5]	[-12.3]	[-25]**	[-40]**	[-55]	[-60]	[-63]	[-65]	[-71]	

NOTE: * For equipment supporting QPSK, 8-PSK, 16-QAM or 32-QAM, the requirement for these modulations is -54 dB.
 NOTE: ** The requirement shall be [tbd] when the wideband pulse shaping filter with the tight spectrum mask is indicated (see Pulse Format Information Element in 3GPP TS 44.060).
 NOTE: *** the requirement shall be [tbd] when the wide pulse shaping filter with the tight spectrum mask is indicated (see Pulse Format Information Element in 3GPP TS 44.060).

Note: GSM 700 MS shall also comply to the requirements in the applicable FCC rules [FCC Part 27, Subpart C, Section 27.53]. This may introduce more stringent requirements in frequency bands defined for public safety services.

a2) GSM 400, GSM 900, GSM 850, MXM 850 and GSM 700 normal BTS:

Case 1	Power level	100	200	250	400	≥ 600 < 1 200	≥ 1 200 < 1 800	≥ 1 800 < 6 000	≥ 6 000
	≥ 43	+0,5	-30	-33	-60*	-70	-73	-75	-80
41	+0,5	-30	-33	-60*	-68	-71	-73	-80	
39	+0,5	-30	-33	-60*	-66	-69	-71	-80	
37	+0,5	-30	-33	-60*	-64	-67	-69	-80	
35	+0,5	-30	-33	-60*	-62	-65	-67	-80	
≤ 33	+0,5	-30	-33	-60*	-60	-63	-65	-80	

NOTE 1: * For equipment supporting QPSK, AQPSK, 8-PSK, 16-QAM or 32-QAM, the requirement for these modulations is -56 dB.
 NOTE 2: The requirements in this table also apply to multicarrier BTS when one carrier is active, for the listed frequency bands.
 NOTE 3: In case of AQPSK the requirements in this table apply to all values of α (see 3GPP TS 45.004) supported by the BTS.

Note: GSM 700 BTS shall also comply to the requirements in the applicable FCC rules [FCC Part 27, Subpart C, Section 27.53]. This may introduce more stringent requirements in frequency bands defined for public safety services.

a3) GSM 900 and GSM 850 and MXM 850 and GSM 700 micro-BTS:

Case 1	Power level	100	200	250	400	≥ 600 < 1 200	≥ 1 200 < 1 800	≥ 1 800
	≤ 33	+0,5	-30	-33	-60*	-60	-63	-70

NOTE 1: * For equipment supporting QPSK, AQPSK, 8-PSK, 16-QAM or 32-QAM, the requirement for these modulations is -56 dB.
 NOTE 2: In case of AQPSK the requirements in this table apply to all values of α (see 3GPP TS 45.004) supported by the BTS.

Note: GSM 700 micro-BTS shall also comply to the requirements in the applicable FCC rules [FCC Part 27, Subpart C, Section 27.53]. This may introduce more stringent requirements in frequency bands defined for public safety services.

a4) GSM 900 and GSM 850 and MXM 850 and GSM 700 pico-BTS:

	Power level	100	200	250	400	≥ 600 < 1 200	≥ 1 200 < 1 800	≥ 1 800 < 6 000	≥ 6 000
Case 1	≤ 20	+0,5	-30	-33	-60*	-60	-63	-70	-80
NOTE 1: * For equipment supporting QPSK, AQPSK, 8-PSK, 16-QAM or 32-QAM, the requirement for these modulations is -56 dB.									
NOTE 2: In case of AQPSK the requirements in this table apply to all values of α (see 3GPP TS 45.004) supported by the BTS.									

Note: GSM 700 pico-BTS shall also comply to the requirements in the applicable FCC rules [FCC Part 27, Subpart C, Section 27.53]. This may introduce more stringent requirements in frequency bands defined for public safety services.

b1) DCS 1 800 MS:

	Power Level	100	200	250	400	≥ 600 < 1 800	≥ 1 800 < 6 000	≥ 6 000		
Case 1	≥ 36	+0,5	-30	-33	-60	-60	-71	-79		
	34	+0,5	-30	-33	-60	-60	-69	-77		
	32	+0,5	-30	-33	-60	-60	-67	-75		
	30	+0,5	-30	-33	-60*	-60	-65	-73		
	28	+0,5	-30	-33	-60*	-60	-63	-71		
	26	+0,5	-30	-33	-60*	-60	-61	-69		
	≤ 24	+0,5	-30	-33	-60*	-60	-59	-67		
Case 2	Power Level	[100]	[200]	[250]	[400]	[600]	≥ [800] < 1 800	≥ 1 800 < 3 000	≥ 3 000 < 6 000	≥ 6 000
	≥ 36	[+0,5]	[-12.3]	[-25]**	[-40]**	[-55]	[-60]	[-63]	[-65]	[-71]
	34	[+0,5]	[-12.3]	[-25]**	[-40]**	[-55]	[-60]	[-63]	[-65]	[-71]
	32	[+0,5]	[-12.3]	[-25]**	[-40]**	[-55]	[-60]	[-63]	[-65]	[-71]
	30	[+0,5]	[-12.3]	[-25]**	[-40]**	[-55]	[-60]	[-63]	[-65]	[-71]
	28	[+0,5]	[-12.3]	[-25]**	[-40]**	[-55]	[-60]	[-63]	[-65]	[-71]
	26	[+0,5]	[-12.3]	[-25]**	[-40]**	[-55]	[-60]	[-63]	[-65]	[-71]
	≤ 24	[+0,5]	[-12.3]	[-25]**	[-40]**	[-55]	[-60]	[-63]	[-65]	[-71]
NOTE: * For equipment supporting QPSK, 8-PSK, 16-QAM or 32-QAM, the requirement for these modulations is -54 dB.										
NOTE: ** The requirement shall be [tbd] when the wideband pulse shaping filter with the tight spectrum mask is indicated (see Pulse Format Information Element in 3GPP TS 44.060).										
NOTE: *** the requirement shall be [tbd] when the wide pulse shaping filter with the tight spectrum mask is indicated (see Pulse Format Information Element in 3GPP TS 44.060).										

b2) DCS 1 800 normal BTS:

	Power level	100	200	250	400	≥ 600 < 1 200	≥ 1 200 < 1 800	≥ 1 800 < 6 000	≥ 6 000
Case 1	≥ 43	+0,5	-30	-33	-60*	-70	-73	-75	-80
	41	+0,5	-30	-33	-60*	-68	-71	-73	-80
	39	+0,5	-30	-33	-60*	-66	-69	-71	-80
	37	+0,5	-30	-33	-60*	-64	-67	-69	-80
	35	+0,5	-30	-33	-60*	-62	-65	-67	-80
	≤ 33	+0,5	-30	-33	-60*	-60	-63	-65	-80
NOTE 1: * For equipment supporting QPSK, AQPSK, 8-PSK, 16-QAM or 32-QAM, the requirement for these modulations is -56 dB.									
NOTE 2: The requirements in this table also apply to multicarrier BTS when one carrier is active, for the DCS 1 800 band.									
NOTE 3: In case of AQPSK the requirements in this table apply to all values of α (see 3GPP TS 45.004) supported by the BTS.									

b3) DCS 1 800 micro-BTS:

	Power level	100	200	250	400	≥ 600 < 1 200	≥ 1 200 < 1 800	≥ 1 800
Case 1	35	+0,5	-30	-33	-60*	-62	-65	-76
	≤ 33	+0,5	-30	-33	-60*	-60	-63	-76

NOTE 1: * For equipment supporting QPSK, AQPSK, 8-PSK, 16-QAM or 32-QAM, the requirement for these modulations is -56 dB.
 NOTE 2: In case of AQPSK the requirements in this table apply to all values of α (see 3GPP TS 45.004) supported by the BTS.

b4) DCS 1 800 pico-BTS:

	Power level	100	200	250	400	≥ 600 < 1 200	≥ 1 200 < 1 800	≥ 1 800 < 6 000	≥ 6 000
Case 1	≤ 23	+0,5	-30	-33	-60*	-60	-63	-76	-80

NOTE 1: * For equipment supporting QPSK, AQPSK, 8-PSK, 16-QAM or 32-QAM, the requirement for these modulations is -56 dB.
 NOTE 2: In case of AQPSK the requirements in this table apply to all values of α (see 3GPP TS 45.004) supported by the BTS.

c1) PCS 1 900 MS:

	Power level	100	200	250	400	≥ 600 < 1 200	≥ 1 200 < 1 800	≥ 1 800 < 6 000	≥ 6 000	
Case 1	≥ 33	+0,5	-30	-33	-60	-60	-60	-68	-76	
	32	+0,5	-30	-33	-60	-60	-60	-67	-75	
	30	+0,5	-30	-33	-60*	-60	-60	-65	-73	
	28	+0,5	-30	-33	-60*	-60	-60	-63	-71	
	26	+0,5	-30	-33	-60*	-60	-60	-61	-69	
	≤ 24	+0,5	-30	-33	-60*	-60	-60	-59	-67	
Case 2	Power level	[100]	[200]	[250]	[400]	[600]	≥ [800] < 1 800	≥ 1 800 < 3 000	≥ 3 000 < 6 000	≥ 6 000
	≥ 33	[+0,5]	[-12.3]	[-25]**	[-40]***	[-55]	[-60]	[-63]	[-65]	[-71]
	32	[+0,5]	[-12.3]	[-25]**	[-40]***	[-55]	[-60]	[-63]	[-65]	[-71]
	30	[+0,5]	[-12.3]	[-25]**	[-40]***	[-55]	[-60]	[-63]	[-65]	[-71]
	28	[+0,5]	[-12.3]	[-25]**	[-40]***	[-55]	[-60]	[-63]	[-65]	[-71]
	26	[+0,5]	[-12.3]	[-25]**	[-40]***	[-55]	[-60]	[-63]	[-65]	[-71]
	≤ 24	[+0,5]	[-12.3]	[-25]**	[-40]***	[-55]	[-60]	[-63]	[-65]	[-71]

NOTE: * For equipment supporting QPSK, 8-PSK, 16-QAM or 32-QAM, the requirement for these modulations is -54 dB.
 NOTE: ** The requirement shall be [tbd] when the wideband pulse shaping filter with the tight spectrum mask is indicated (see Pulse Format Information Element in 3GPP TS 44.060).
 NOTE: *** the requirement shall be [tbd] when the wide pulse shaping filter with the tight spectrum mask is indicated (see Pulse Format Information Element in 3GPP TS 44.060).

c2) PCS 1 900 & MXM 1900 normal BTS:

	Power level	100	200	250	400	≥ 600 $< 1\,200$	$\geq 1\,200$ $< 1\,800$	$\geq 1\,800$ $< 6\,000$	$\geq 6\,000$
Case 1	≥ 43	+0,5	-30	-33	-60*	-70	-73	-75	-80
	41	+0,5	-30	-33	-60*	-68	-71	-73	-80
	39	+0,5	-30	-33	-60*	-66	-69	-71	-80
	37	+0,5	-30	-33	-60*	-64	-67	-69	-80
	35	+0,5	-30	-33	-60*	-62	-65	-67	-80
	≤ 33	+0,5	-30	-33	-60*	-60	-63	-65	-80
NOTE 1: * For equipment supporting QPSK, AQPSK, 8-PSK, 16-QAM or 32-QAM, the requirement for these modulations is -56 dB.									
NOTE 2: The requirements in this table also apply to multicarrier BTS when one carrier is active, for the PCS 1 900 band.									
NOTE 3: In case of AQPSK the requirements in this table apply to all values of α (see 3GPP TS 45.004) supported by the BTS.									

c3) PCS 1 900 & MXM 1900 micro-BTS:

	Power level	100	200	250	400	≥ 600 $< 1\,200$	$\geq 1\,200$ $< 1\,800$	$\geq 1\,800$
Case 1	35	+0,5	-30	-33	-60*	-62	-65	-76
	≤ 33	+0,5	-30	-33	-60*	-60	-63	-76
NOTE 1: * For equipment supporting QPSK, AQPSK, 8-PSK, 16-QAM or 32-QAM, the requirement for these modulations is -56 dB.								
NOTE 2: In case of AQPSK the requirements in this table apply to all values of α (see 3GPP TS 45.004) supported by the BTS.								

c4) PCS 1 900 and MXM 1900 pico-BTS:

	Power level	100	200	250	400	≥ 600 $< 1\,200$	$\geq 1\,200$ $< 1\,800$	$\geq 1\,800$
Case 1	≤ 23	+0,5	-30	-33	-60*	-60	-63	-76
NOTE 1: * For equipment supporting QPSK, AQPSK, 8-PSK, 16-QAM or 32-QAM, the requirement for these modulations is -56 dB.								
NOTE 2: In case of AQPSK the requirements in this table apply to all values of α (see 3GPP TS 45.004) supported by the BTS.								

4.2.1.4 Exceptions for spectrum due to modulation and wideband noise

4.2.1.4.1 Mobile Stations and Base Transceiver Stations except multicarrier BTS

The following exceptions shall apply, using the same measurement conditions as specified above.

- i) In the combined range 600 kHz to 6 MHz above and below the carrier, in up to three bands of 200 kHz width centred on a frequency which is an integer multiple of 200 kHz, exceptions at up to -36 dBm are allowed.
- ii) Above 6 MHz offset from the carrier in up to 12 bands of 200 kHz width centred on a frequency which is an integer multiple of 200 kHz, exceptions at up to -36 dBm are allowed. For the BTS only one transmitter is active for this test.

Using the same measurement conditions as specified above, if a requirement in tables ax), bx) and cx) is tighter than the limit given in the following, the latter shall be applied instead.

- iii) For MS:

Table 4.2-1 Exceptions for MS wideband noise level

Frequency offset from the carrier	GSM 400 & GSM 900 & GSM 850 & GSM 700	DCS 1 800 & PCS 1 900
< 600 kHz	-36 dBm	-36 dBm
≥ 600 kHz, < 1 800 kHz	-51 dBm	-56 dBm
≥ 1 800 kHz	-46 dBm	-51 dBm

iv) For normal but not for multicarrier BTS, whereby the levels given here in dB are relative to the output power of the BTS at the lowest static power level measured in 30 kHz:

Table 4.2-2 Exceptions for normal BTS wideband noise level

Frequency offset from the carrier	GSM 400 & GSM 900 & GSM 850 & MXM 850 & GSM 700	DCS 1 800 & PCS 1 900 & MXM 1900
< 1 800 kHz	max {-88 dB, -65 dBm}	max {-88 dB, -57 dBm}
≥ 1 800 kHz	max {-83 dB, -65 dBm}	max {-83 dB, -57 dBm}

v) For micro and pico -BTS, at 1 800 kHz and above from the carrier:

Table 4.2-3 Exceptions for micro and pico BTS wideband noise level

Power Class	GSM 900 & GSM 850 & MXM 850 & GSM 700	DCS 1 800 & PCS 1 900 & MXM 1900
M1	-59 dBm	-57 dBm
M2	-64 dBm	-62 dBm
M3	-69 dBm	-67 dBm
P1	-68 dBm	-65 dBm

4.2.1.4.2 Multicarrier BTS

Using the same measurement conditions as specified above for multicarrier BTS, following exceptions are allowed for BTS belonging to the multicarrier BTS class when one or more carriers are active:

- vi) At offsets between 600 kHz above the uppermost and below the lowermost carrier, respectively, and 10 MHz outside the transmit band, in bands of 200 kHz width centered on a frequency, which is an integer multiple of 200 kHz, exceptions are allowed for N active carriers at $M = 18 + 3 * (N - 1)$ or up to maximum 40 bands, whichever the lowest. All exceptions are measured in 100 kHz bandwidth, averaged over the 200 kHz band and may be up to -36 dBm. In addition, all exceptions within the relevant transmit band and up to four exceptions at offsets up to 2 MHz from the respective band edges, may be up to -70 dBc relative to the carrier measured in a bandwidth of 100 kHz, or -36 dBm, whichever less stringent.
- vii) At offsets larger than 600 kHz from the carrier, if a requirement in tables a2), b2) and c2), adjusted according to the multicarrier BTS requirements, is more stringent than -47 dBm, the latter requirement shall be applied instead.
- viii) The following applies in case of a non-contiguous frequency allocation as defined in clause 3: The same total number of exceptions M for N active carriers apply as given in vi) including the range of frequency offsets between 0.6 MHz above the uppermost carrier of the lower frequency group and 0.6 MHz below the lowermost carrier of the upper frequency group.

4.2.2 Spectrum due to switching transients

4.2.2.1 General requirements

Those effects are also measured in the time domain and the specifications assume the following measurement conditions: zero frequency scan, filter bandwidth 30 kHz, peak hold, and video bandwidth 100 kHz.

In case of the multicarrier BTS class, the measurement of the switching transients outside the BTS transmit band is covered by a measurement procedure stated in subclause 4.3 (Spurious emissions). For measurements of switching transients inside the transmit band, the measurement is performed with a single active carrier at maximum declared power..

The example of a waveform due to a burst as seen in a 30 kHz filter offset from the carrier is given thereunder (figure 1).

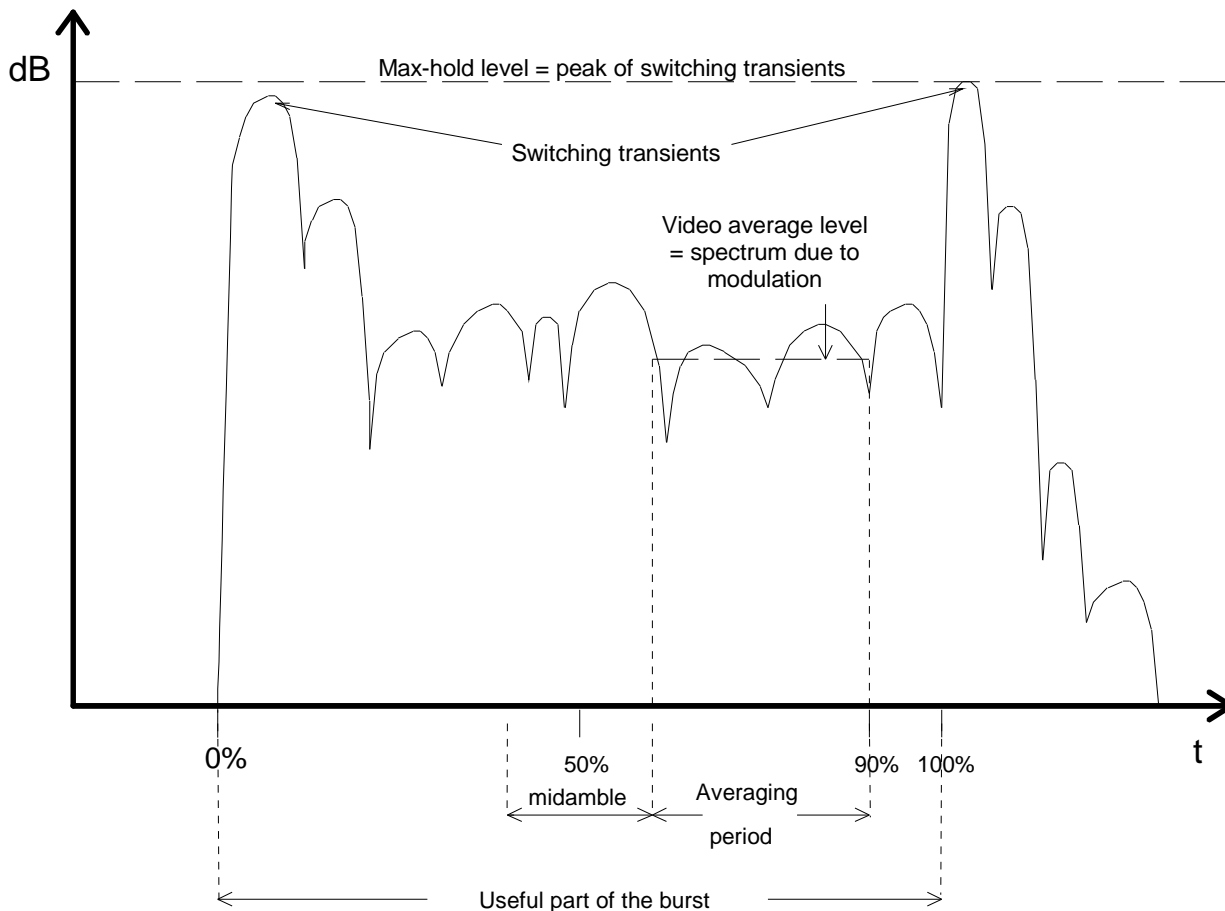

Figure 4.2-1: Example of a time waveform due to a burst as seen in a 30 kHz filter offset from the carrier

a) Mobile Station:

Table 4.2-3a Requirements for switching transients - MS

Power level	Maximum level measured			
	400 kHz	600 kHz	1 200 kHz	1 800 kHz
39 dBm	-21 dBm	-26 dBm	-32 dBm	-36 dBm
≤ 37 dBm	-23 dBm	-26 dBm	-32 dBm	-36 dBm

NOTE 1: The relaxation's for power level 39 dBm is in line with the modulated spectra and thus causes negligible additional interference to an analogue system by a GSM signal.

NOTE 2: The near-far dynamics with this specification has been estimated to be approximately 58 dB for MS operating at a power level of 8 W or 49 dB for MS operating at a power level of 1 W. The near-far dynamics then gradually decreases by 2 dB per power level down to 32 dB for MS operating in cells with a maximum allowed output power of 20 mW or 29 dB for MS operating at 10 mW.

NOTE 3: The possible performance degradation due to switching transient leaking into the beginning or the end of a burst, was estimated and found to be acceptable with respect to the BER due to cochannel interference (C/I).

b) Base transceiver station:

The maximum level measured, after any filters and combiners, at the indicated offset from the carrier, is:

Table 4.2-3b Requirements for switching transients - BTS

	Maximum level measured			
	400 kHz	600 kHz	1 200 kHz	1 800 kHz
GSM 400 & GSM 900 & GSM 850 & MXM 850 & GSM 700 (GMSK)	-57 dBc	-67 dBc	-74 dBc	-74 dBc
GSM 400 & GSM 900 & GSM 850 & MXM 850 & GSM 700 (QPSK, 8-PSK, 16-QAM, 32-QAM)	-52 dBc	-62 dBc	-74 dBc	-74 dBc
DCS 1 800 & PCS 1 900 & MXM 1900 (GMSK)	-50 dBc	-58 dBc	-66 dBc	-66 dBc
DCS 1 800 & PCS 1 900 & MXM 1900 (QPSK, 8-PSK, 16-QAM, 32-QAM)	-50 dBc	-58 dBc	-66 dBc	-66 dBc

Or -36 dBm, whichever is the higher.

dBc means relative to the output power at the BTS, measured at the same point and in a filter bandwidth of at least 300 kHz.

NOTE 4: Some of the above requirements are different from those specified in subclause 4.3.2.

4.3 Spurious emissions

The limits specified thereunder are based on a 5-pole synchronously tuned measurement filter.

In addition to the requirements of this section, the PCS 1 900 & MXM 1900 BTS and PCS 1 900 MS shall also comply with the applicable limits for spurious emissions established by the FCC rules for wideband PCS services [FCC Title 47 CFR Part 24].

In addition to the requirements of this section, the GSM 850 & MXM 850 BTS and GSM 850 MS shall also comply with the applicable limits for spurious emissions established by the FCC rules for public mobile services [FCC Part 22, Subpart H].

In addition to the requirements of this section, the GSM 700 BTS and GSM 700 MS shall also comply with the applicable limits for spurious emissions established by the FCC [FCC Part 27, Subpart C, Section 27.53].

Note: This may introduce more stringent requirements than specified in this subclause for frequency bands dedicated for public safety services.

4.3.1 Principle of the specification

In this subclause, the spurious transmissions (whether modulated or unmodulated) and the switching transients are specified together by measuring the peak power in a given bandwidth at various frequencies. The bandwidth is increased as the frequency offset between the measurement frequency and, either the carrier, or the edge of the MS or BTS transmit band, increases. The effect for spurious signals of widening the measurement bandwidth is to reduce the allowed total spurious energy per MHz. The effect for switching transients is to effectively reduce the allowed level of the switching transients (the peak level of a switching transient increases by 6 dB for each doubling of the measurement bandwidth). The conditions are specified in the tables 4.3-1 and 4.3-2, a peak-hold measurement being assumed.

In case of the multicarrier BTS class, instead of a peak-hold measurement an average measurement is assumed. Furthermore, the measurement configuration as defined in 4.2.1 for the multicarrier BTS class shall be applied.

The measurement conditions for radiated and conducted spurious are specified separately in 3GPP TS 51.010 and 3GPP TS 51.02x series. The frequency bands where these are actually measured may differ from one type to the other (see 3GPP TS 51.010 and 3GPP TS 51.02x series).

a) Measurement bandwidth for inband measurements of spurious emissions

Table 4.3-1 Measurement bandwidth for inband measurements

Band	Frequency offset (offset from carrier)	Measurement bandwidth
relevant transmit band	≥ 1,8 MHz	30 kHz
	≥ 6 MHz	100 kHz

b) Measurement bandwidth for out-of-band measurements of spurious emissions

Table 4.3-2 Measurement bandwidth for out-of-band measurements

Band	Frequency offset	Measurement bandwidth
100 kHz to 50 MHz	-	10 kHz
50 MHz to 500 MHz and outside the relevant transmit band	(offset from edge of the relevant transmit band)	
	≥ 2 MHz	30 kHz
	≥ 5 MHz	100 kHz
500 MHz to 1000 MHz and outside the relevant transmit band	(offset from edge of the relevant transmit band)	
	≥ 2 MHz	30 kHz
	≥ 5 MHz	100 kHz
	≥ 10 MHz	300 kHz
	≥ 20 MHz	1 MHz
	≥ 30 MHz	3 MHz
Above 1000 MHz and outside the relevant transmit band	(offset from edge of the relevant transmit band)	
	≥ 2 MHz	30 kHz
	≥ 5 MHz	100 kHz
	≥ 10 MHz	300 kHz / 1 MHz ^(note)
	≥ 20 MHz	1 MHz
	≥ 30 MHz	3 MHz

NOTE: 1 MHz measurement bandwidth applies only to BTS belonging to the multicarrier BTS class.

The measurement settings assumed correspond, for the resolution bandwidth to the value of the measurement bandwidth in the table, and for the video bandwidth to approximately three times this value.

NOTE: For radiated spurious emissions for MS with antenna connectors, and for all spurious emissions for MS with integral antennas, the specifications currently only apply to the frequency band 30 MHz to 4 GHz. The specification and method of measurement outside this band are under consideration.

c) Relation to definitions and requirements in CEPT/ERC/REC 74-01 and ITU-R SM.329

In this subclause for all equipment the term Spurious emission out-of-band is used for all spurious transmissions outside the relevant transmit band (whether modulated or unmodulated), comprised of contributions from noise, intermodulation and non-harmonic emissions. For multicarrier BTS the definition of the requirements are aligned with the definitions in ITU-R SM.329 [34] and REC 74-01 in that

- Unwanted emissions in multicarrier operation are specified in subclause 4.2.1 (including the reference to intermodulation subclause 4.7.2) in present specification, both for inband and out-of band emissions from 0 MHz up to 2*BW frequency offset from edge of relevant transmit frequency band.
- Minimum required frequency allocation for each operator is assumed to be 5 MHz, i.e. BW is 5 MHz.

- Spurious emissions according to REC 74-01 definition are specified in subclause 4.3.2 from $2 \cdot BW = 10$ MHz and higher frequency offsets. The 10 MHz spurious domain boundary applies also for larger transmitter bandwidths.
- In addition there is an upper limit for the unwanted emissions from 0 to 10 MHz frequency offset outside the relevant transmit band edge according to 4.3.2.1.
- The relevant transmit bands are defined in clause 2.

4.3.2 Base Transceiver Station

4.3.2.1 General requirements

i) The power measured in the conditions specified in subclause 4.3.1a shall be no more than -36 dBm. In case of multicarrier BTS, the requirements in subclause 4.2.1 for single carrier operation apply for the case of declared maximum output power.

ii) The power measured in the conditions specified in subclause 4.3.1b shall be no more than:

Table 4.3-3 Requirements for spurious emissions – out of relevant transmit band

Band	Frequency offset outside relevant transmit band	All BTS except multicarrier BTS	Multicarrier BTS
		Maximum power limit	Maximum power limit
9 kHz to 1 GHz	≥ 2 MHz	-36 dBm (250 nW)	-25 dBm
	≥ 5 MHz	-36 dBm	$-20-4,2 \cdot (\Delta f - 5)$ dBm (Note)
	≥ 10 MHz	-36 dBm	-36 dBm
1 GHz to 12.75 GHz	≥ 2 MHz	-30 dBm (1 μ W)	-25 dBm
	≥ 5 MHz	-30 dBm	$-20-3 \cdot (\Delta f - 5)$ dBm (Note)
	≥ 10 MHz	-30 dBm	-30 dBm

Note: Δf is the frequency offset outside relevant transmit band in MHz

In case of multicarrier BTS, for frequency offsets between 0 and 10 MHz, the most stringent requirements of the requirements in the table above and the requirements in subclause 4.2.1 for multicarrier BTS with more than one carrier active apply.

In addition, applicable protection of critical services, in frequency bands outside the relevant TX band needs to be considered and measures taken to assure uninterrupted operation, according to additional requirements as defined by the regional regulator.

NOTE 1: For radiated spurious emissions for BTS, the specifications currently only apply to the frequency band 30 MHz to 4 GHz. The specification and method of measurement outside this band are under consideration.

iii) In the BTS receive band, the power measured using the conditions specified in subclause 4.2.1, with a filter and video bandwidth of 100 kHz shall be no more than :

Table 4.3-4 Requirements for spurious emissions – BTS receive band

	GSM 900 & GSM 850 & MXM 850 & GSM 700 (dBm)	DCS 1800 & PCS 1900 & MXM 1900 (dBm)
Normal BTS	-98	-98
Micro BTS M1	-91	-96
Micro BTS M2	-86	-91
Micro BTS M3	-81	-86
Pico BTS P1	-70	-80
R-GSM 900 BTS	-89	

These values assume a 30 dB coupling loss between transmitter and receiver. If BTSs of different classes are co-sited, the coupling loss must be increased by the difference between the corresponding values from the table above.

iv) In case of BTSs belonging to the multicarrier BTS class, the measurement of the spurious emissions outside the BTS transmit band shall be conducted for the case of maximum supported number of carriers at maximum nominal power for each carrier while performing burst on/off keying. For measurements inside the relevant transmit band the measurement conditions and requirement in 4.2.1 regarding operation with one carrier active apply.

4.3.2.2 Additional requirements for co-existence with GSM systems on other frequency bands

i) For co-existence in the same geographic area, the powers measured in the conditions specified in subclause 4.2.1, with a filter and video bandwidth of 100 kHz, shall be no more than specified in table below:

Table 4.3-5 Requirements for spurious emissions – co-existence with GSM systems on other frequency bands

For co-existence with BTS:	Frequency band	Power measured (dBm)	Required for BTS (Note 3)
GSM 900	921 – 960 MHz	≤ -57	T-GSM 810, GSM 400 & DCS 1800
DCS 1800	1805 – 1880 MHz	≤ -47	T-GSM 810, GSM 400 & GSM 900
GSM 400	460.4 – 467.6 MHz and 488.8 – 496.0 MHz.	≤ -57	T-GSM 810, GSM 900 & DCS 1800 (Note 1)
PCS 1900 & MXM 1900	1930 – 1990 MHz	≤ -47	GSM 700, GSM 850, MXM 850
GSM 850 & MXM 850	869 - 894 MHz	≤ -57	GSM 700, PCS 1900 & MXM 1900 (Note 2)
GSM 700	728 – 746 MHz and 747 – 763 MHz	≤ -57	GSM 850, MXM 850, PCS 1900 & MXM 1900 (Note 2)
T-GSM 810	851 – 866 MHz	≤ -57	GSM 400, GSM 900 & DCS 1800

NOTE 1: These requirements should also be applied to GSM 900 and DCS 1800 BTS built to a HW specification for R98 or earlier.

NOTE 2: These requirements should also be applied to GSM 850 & MXM 850 BTS and PCS 1900 & MXM 1900 BTS built to a HW specification for R99 or earlier.

NOTE 3: These requirements should also be applied to any additional combination of BTSs in different frequency bands operating in the same geographic area.

ii) Measures must be taken for mutual protection of receivers when BTS of different bands are co-sited.

NOTE 4: Thus, for this case, then the power measured from the BTS transmitter in the conditions specified in subclause 4.2.1, with a filter and video bandwidth of 100 kHz should be no more than the values in the table 4.3-4 in subclause 4.3.2.1, assuming the coupling losses stated in the same subclause, to protect co-sited BTS receivers for

- GSM 400 in the bands 450.4 – 457.6 MHz and 478.8 – 486.0 MHz
- T-GSM 810 in the band 806– 821 MHz
- GSM 900 in the band 876 – 915 MHz
- DCS 1800 in the band 1710 – 1785 MHz
- PCS 1900 or MXM 1900 in the band 1850 – 1910 MHz
- GSM 850 or MXM 850 in the band 824 – 849 MHz
- GSM 700 in the bands 698 – 716 MHz and 777 – 793 MHz

4.3.2.3 Additional requirements for co-existence with 3 G

i) In geographic areas where GSM and UTRA networks are deployed, the power measured in the conditions specified in subclause 4.2.1, with a filter and video bandwidth of 100 kHz shall be no more than:

Table 4.3-6 Requirements for spurious emissions – co-existence with 3 G systems on other frequency bands

Band (MHz)	power (dBm)	Note
832 - 862	-62	E-UTRA/FDD BS Rx band
791 - 821	-62	E-UTRA/FDD UE Rx band
1880 - 1920 ^(Note)	-62	E-UTRA/TDD band
1900 – 1920	-62	UTRA/TDD band
1920 – 1980	-62	UTRA/FDD BS Rx band
2010 – 2025	-62	UTRA/TDD band
2110 – 2170	-62	UTRA/FDD UE Rx band
2300 - 2400	-62	E-UTRA/TDD band
2500 – 2570	-62	E-UTRA/FDD BS Rx band
2570-2620	-62	E-UTRA/TDD band
2620-2690	-62	E-UTRA/FDD UE Rx band
Note: Only if regionally required		

ii) When GSM and UTRA BS are co-located, the power measured in the conditions specified in subclause 4.2.1, with a filter and video bandwidth of 100 kHz shall be no more than:

Table 4.3-7 Requirements for spurious emissions – co-located BTS with 3 G BS on other frequency bands

Band (MHz)	power (dBm)	Note
832 - 862	-96	E-UTRA/FDD BS Rx band
791 - 821	-62	E-UTRA/FDD UE Rx band
1880 - 1920 ^(Note)	-96	E-UTRA/TDD band
1900 – 1920	-96	UTRA/TDD band
1920 – 1980	-96	UTRA/FDD BS Rx band
2010 – 2025	-96	UTRA/TDD band
2110 – 2170	-62	UTRA/FDD UE Rx band
2300 - 2400	-96	E-UTRA/TDD band
2500 – 2570	-96	E-UTRA/FDD BS Rx band
2570-2620	-96	E-UTRA/TDD band
2620-2690	-62	E-UTRA/FDD UE Rx band

Note: Only if regionally required

Note 1: The requirements in this subclause should also be applied to BTS built to a hardware specification for R98 or earlier. For a BTS built to a hardware specification for R98 or earlier, with an 8-PSK capable transceiver installed, the 8-PSK transceiver shall meet the R99 requirement.

4.3.3 Mobile Station

4.3.3.1 Mobile Station GSM 400, T-GSM 810, GSM 900 and DCS 1 800

i) The power measured in the conditions specified in subclause 4.3.1a, for a MS when assigned a channel, shall be no more than -36 dBm. For R-GSM 900 MS except small MS the corresponding limit shall be -42 dBm.

ii) The power measured in the conditions specified in subclause 4.3.1b for a MS, when assigned a channel, shall be no more than (see also note in subclause 4.3.1b above):

- 250 nW (-36 dBm) in the frequency band 9 kHz to 1 GHz;
- 1 μ W (-30 dBm) in the frequency band 1 GHz to 12,75 GHz.

The power measured in a 100 kHz bandwidth for a MS, when not assigned a channel (idle mode), shall be no more than (see also note in subclause 4.3.1 above):

- 2 nW (-57 dBm) in the frequency bands 9 kHz to 1 000 MHz;
- 20 nW (-47 dBm) in the frequency bands 1 - 12.75 GHz,

with the following exceptions:

- -76 dBm in the frequency band 832 to 862 MHz;
- 1.25 nW (-59 dBm) in the frequency band 880 MHz to 915 MHz;
- 5 nW (-53 dBm) in the frequency band 1,71 GHz to 1,785 GHz;

- -76 dBm in the frequency bands 1900 – 1920 MHz, 1920 – 1980 MHz, 2010 – 2025 MHz, 2110 - 2170 MHz and 2300 – 2400 MHz;
- -76 dBm in the frequency bands 2500-2570 MHz, 2570-2620 MHz and 2620-2690 MHz.

NOTE: The idle mode spurious emissions in the receive band are covered by the case for MS assigned a channel (see below).

iii) When assigned a channel, the power emitted by the MS, when measured using the measurement conditions specified in subclause 4.2.1, but with averaging over at least 50 burst measurements, with a filter and video bandwidth of 100 kHz, for measurements centred on 200 kHz multiples shall be no more than:

- -62 dBm in the bands 390.2 - 400 MHz and 420.2 - 430 MHz for T-GSM 380 and T-GSM 410 MS only;
- -67 dBm in the bands 460.4 – 467.6 MHz and 488.8 - 496 MHz for GSM400 MS only;
- -66 dBm in the band 791 - 821 MHz
- -79 dBm in the band 851- 866 MHz for T-GSM 810 MS only;
- -60 dBm in the band 921 - 925 MHz for R-GSM MS only;
- -67 dBm in the band 925 - 935 MHz;
- -79 dBm in the band 935 –960 MHz;
- -71 dBm in the band 1805 - 1880 MHz;
- -66 dBm in the bands 1900 - 1920 MHz, 1920 - 1980 MHz, 2010 - 2025 MHz, 2110 - 2170 MHz and 2300 – 2400 MHz.

As exceptions up to five measurements with a level up to -36 dBm are permitted in each of the bands 791 MHz to 821 MHz, 851 MHz to 866 MHz, 925 MHz to 960 MHz, 1 805 MHz to 1 880 MHz, 1900 - 1920 MHz, 1920 - 1980 MHz, 2010 - 2025 MHz, and 2110 - 2170 MHz for each ARFCN used in the measurements. For GSM 400 MS, in addition, exceptions up to three measurements with a level up to -36 dBm are permitted in each of the bands 460,4 MHz to 467,6 MHz and 488,8 MHz to 496 MHz for each ARFCN used in the measurements.

When hopping, this applies to each set of measurements, grouped by the hopping frequencies as described in subclause 4.2.1.

4.3.3.2 Mobile Station GSM 700, GSM 850 and PCS 1 900

- i) The peak power measured in the conditions specified in subclause 4.3.1a, for a MS when assigned a channel, shall be no more than -36 dBm.
- ii) The peak power measured in the conditions specified in subclause 4.3.1b for a MS, when assigned a channel, shall be no more than:
- -36 dBm in the frequency band 9 kHz to 1 GHz;
 - -30 dBm in all other frequency bands 1 GHz to 12,75 GHz.

The peak power measured in a 100 kHz bandwidth for a mobile, when not assigned a channel (idle mode), shall be no more than:

- -57 dBm in the frequency bands 9 kHz to 1000 MHz;
- -53 dBm in the frequency band 1 850 MHz to 1 910 MHz;
- -47 dBm in all other frequency bands 1 GHz to 12,75 GHz.

iii) The power emitted by the MS in a 100 kHz bandwidth using the measurement techniques for modulation and wide band noise (subclause 4.2.1) shall not exceed:

- -73 dBm in the frequency band 728 MHz to 736 MHz
- -66 dBm in the frequency band 791 MHz to 806 MHz

- -79 dBm in the frequency band 736 MHz to 746 MHz
- -79 dBm in the frequency band 747 MHz to 757 MHz
- -73 dBm in the frequency band 757 MHz to 763 MHz
- -79 dBm in the frequency band 869 MHz to 894 MHz;
- -71 dBm in the frequency band 1 930 MHz to 1 990 MHz.

A maximum of five exceptions with a level up to -36 dBm are permitted in each of the band 728 MHz to 746 MHz, 747 MHz to 763 MHz, 791 MHz to 806 MHz, 869 MHz to 894 MHz and 1 930 MHz to 1 990 MHz for each ARFCN used in the measurements.

4.4 Radio frequency tolerance

The radio frequency tolerance for the base transceiver station and the MS is defined in 3GPP TS 45.010.

4.5 Output level dynamic operation

NOTE: The term "any transmit band channel" is used here to mean:

- any RF channel of 200 kHz bandwidth centred on a multiple of 200 kHz which is within the relevant transmit band.

4.5.1 Base Transceiver Station

The BTS shall be capable of not transmitting a burst in a time slot not used by a logical channel or where DTX applies. The output power relative to time when sending a burst is shown in annex B. The reference level 0 dB corresponds to the output power level according to subclause 4. In the case where the bursts in two (or several) consecutive time slots are actually transmitted, at the same frequency, the template of annex B shall be respected during the useful part of each burst and at the beginning and the end of the series of consecutive bursts. The output power during the guard period between every two consecutive active timeslots shall not exceed the level allowed for the useful part of the first timeslot, or the level allowed for the useful part of the second timeslot plus 3 dB, whichever is the highest. The residual output power, if a timeslot is not activated, shall be maintained at, or below, a level of -30 dBc on the frequency channel in use. All emissions related to other frequency channels shall be in accordance with the wide band noise and spurious emissions requirements.

A measurement bandwidth of at least 300 kHz is assumed.

4.5.2 Mobile Station

The output power can be reduced by steps of 2 dB as listed in subclause 4.1.

The transmitted power level relative to time when sending a burst is shown in annex B. The reference level 0 dB corresponds to the output power level according to subclause 4. In the case of Multislot Configurations where the bursts in two or more consecutive time slots are actually transmitted at the same frequency, the template of annex B shall be respected during the useful part of each burst and at the beginning and the end of the series of consecutive bursts. The output power during the period between the useful parts of every two consecutive active timeslots shall not exceed the level allowed for the useful part of the first timeslot, or the level allowed for the useful part of the second timeslot plus 3 dB, whichever is the highest. As an exception, in the case of a normal burst being transmitted with a high timing advance immediately after an access burst, a minimum of 8.25 symbol guard period shall be allowed for the MS power ramping and the useful part requirements for the concerned bursts are allowed to be adjusted correspondingly. The timing of the transmitted burst is specified in 3GPP TS 45.010. Between the active bursts, the residual output power shall be maintained at, or below, the level of:

- -59 dBc or -54 dBm, whichever is the greater for GSM 400, GSM 900, GSM 850 and GSM 700, except for the time slot preceding the active slot, for which the allowed level is -59 dBc or -36 dBm whichever is the greater;
- -48 dBc or -48 dBm, whichever is the greater for DCS 1 800 and PCS 1 900;

in any transmit band channel.

A measurement bandwidth of at least 300 kHz is assumed.

The transmitter, when in idle mode, will respect the conditions of subclause 4.3.3.

4.6 Modulation accuracy

4.6.1 GMSK modulation

When transmitting a burst, the phase accuracy of the signal, relative to the theoretical modulated waveforms as specified in 3GPP TS 45.004, is specified in the following way.

For any 148-bits subsequence of the 511-bits pseudo-random sequence, defined in CCITT Recommendation O.153 fascicle IV.4, the phase error trajectory on the useful part of the burst (including tail bits), shall be measured by computing the difference between the phase of the transmitted waveform and the phase of the expected one. The RMS phase error (difference between the phase error trajectory and its linear regression on the active part of the time slot) shall not be greater than 5° with a maximum peak deviation during the useful part of the burst less than 20°.

NOTE: Using the encryption (ciphering mode) is an allowed means to generate the pseudo-random sequence.

The burst timing of the modulated carrier in the active part of the time slot shall be chosen to ensure that all the modulating bits in the useful part of the burst (see 3GPP TS 45.004) influence the output phase in a time slot.

4.6.2 QPSK, AQPSK, 8-PSK, 16-QAM and 32-QAM modulations

The modulation accuracy is defined by the error vector between the vector representing the actual transmitted signal and the vector representing the error-free modulated signal. The magnitude of the error vector is called Error Vector Magnitude (EVM). For definition of the different measures of EVM, see annex G.

When transmitting a burst, the magnitude of the error vector of the signal, relative to the theoretical modulated waveforms as specified in 3GPP TS 45.004, is specified in the following way.

The magnitude of the error vector shall be computed by measuring the error vector between the vector representing the transmitted waveform and the vector representing the ideal one on the useful part of the burst (excluding tail symbols). When measuring the error vector a receive filter at baseband shall be used, defined as

- a raised-cosine filter with roll-off 0,25 and single side-band 6 dB bandwidth 90 kHz for normal symbol rate and for higher symbol-rate using narrow pulse-shaping filter.
- a raised-cosine filter with roll-off 0,25 and single side-band 6 dB bandwidth 108 kHz for higher symbol-rate using wide pulse-shaping filter.

The measurement filter is windowed by multiplying its impulse response by a raised cosine window given as:

$$w(t) = \begin{cases} 1, & 0 \leq |t| \leq 1.5T \\ 0.5 \left(1 + \cos \left[\pi (|t| - 1.5T) / 2.25T \right] \right), & 1.5T \leq |t| \leq 3.75T \\ 0, & |t| \geq 3.75T \end{cases}$$

where T is the normal symbol period.

The transmitted waveforms shall be Normal Bursts for QPSK, AQPSK, 8-PSK, 16-QAM and 32-QAM as defined in 3GPP TS 45.002, with encrypted bits generated using consecutive bits from the 32767 bit length pseudo random sequence defined in ITU-T Recommendation O.151 (1992).

4.6.2.1 RMS EVM

4.6.2.1.1 MS requirements

When transmitting a burst, the magnitude of the error vector of the signal, relative to the theoretical modulated waveforms as specified in 3GPP TS 45.004, is specified in the following way:

- The RMS EVM per burst is measured under the duration of at least 200 bursts.
- The measured RMS EVM over the useful part of any burst, excluding tail bits, shall not exceed;

Table 4.6-1 EVM requirements for MS

	Normal symbol rate		Higher symbol rate		
	8-PSK	16-QAM	QPSK	16-QAM	32-QAM
under normal conditions	9,0 %	7,0%	[9,0 %]	[tbd]	[tbd]
under extreme conditions	10,0 %	8,0%	[10,0 %]	[tbd]	[tbd]

4.6.2.1.2 Requirements for BTS

When transmitting a burst, the magnitude of the error vector of the signal, relative to the theoretical modulated waveforms as specified in 3GPP TS 45.004, is specified in the following way:

- The RMS EVM per burst is measured under the duration of at least 200 bursts.
 - The measured RMS EVM over the useful part of any burst, excluding tail bits, shall not exceed;
- i) after any active element and excluding the effect of any passive combining equipment:

Table 4.6-2a EVM requirements for BTS before combining

	Normal symbol rate				Higher symbol rate		
	AQPSK	8-PSK	16-QAM	32-QAM	QPSK	16-QAM	32-QAM
under normal conditions	7,0 % ¹⁾ 5,0 % ²⁾	7,0 %	5,0 %	5,0 %	7,0 %	4,0 %	4,0 %
under extreme conditions	8,0 % ¹⁾ 6,0 % ²⁾	8,0 %	6,0 %	6,0 %	8,0 %	5,0 %	5,0 %
Note 1: Applicable for absolute SCPIR_DL values \leq 8,0 dB							
Note 2: Applicable for absolute SCPIR_DL values $>$ 8,0 dB							

ii) after any active element and including the effect of passive combining equipment:

Table 4.6-2b EVM requirements for BTS after combining

	Normal symbol rate				Higher symbol rate		
	AQPSK	8-PSK	16-QAM	32-QAM	QPSK	16-QAM	32-QAM
under normal conditions	8,0 % ¹⁾ 6,0 % ²⁾	8,0 %	6,0 %	6,0 %	8,0 %	5,5 %	5,5 %
under extreme conditions	9,0 % ¹⁾ 7,0 % ²⁾	9,0 %	7,0 %	7,0 %	9,0 %	6,5 %	6,5 %
Note 1: Applicable for absolute SCPIR_DL values $\leq 8,0$ dB							
Note 2: Applicable for absolute SCPIR_DL values $> 8,0$ dB							

The RMS EVM per burst is measured under the duration of at least 200 bursts.

4.6.2.2 Origin Offset Suppression

The origin offset shall be measured over at least 200 bursts. For each burst a value shall be calculated using the formula for the origin offset suppression shown in annex G, but before taking the logarithm the average over the number of bursts shall be computed. Then this average shall be transferred to dB scale and the resulting origin offset suppression shall exceed

- 30 dB for MS and
- 35 dB for all types of BTS

under normal and extreme conditions.

4.6.2.3 Peak EVM

The peak value of EVM is the peak error deviation within a burst, measured at each symbol interval, averaged over at least 200 bursts to reflect the transient nature of the peak deviation. The bursts shall have a minimum distance in time of 7 idle timeslots between them. The peak EVM values are acquired during the useful part of the burst, excluding tail bits.

- The measured peak EVM values shall be ≤ 30 % for MS under normal and extreme conditions.
- The measured peak EVM values shall be ≤ 22 % for all types of BTS under normal and extreme conditions. The effect of any passive combining equipment is excluded.

4.6.2.4 95:th percentile

The 95:th percentile is the point where 95% of the individual EVM values, measured at each symbol interval, is below that point. That is, only 5% of the symbols are allowed to have an EVM exceeding the 95:th-percentile point. The EVM values are acquired during the useful part of the burst, excluding tail bits, over 200 bursts.

- The measured 95:th-percentile value shall be ≤ 15 % for MS under normal and extreme conditions.
- The measured 95:th-percentile value shall be ≤ 11 % for all types of BTS under normal and extreme conditions. The effect of any combining equipment is excluded.

4.7 Intermodulation attenuation

The intermodulation attenuation is the ratio of the power level of the wanted signal to the power level of an intermodulation component. It is a measure of the capability of the transmitter to inhibit the generation of signals in its

non-linear elements caused by the presence of the carrier and an interfering signal reaching the transmitter via the antenna, or by non linear combining and amplification of multiple carriers.

4.7.1 Base transceiver station

An interfering CW signal shall be applied to the transmit antenna port, within the relevant BTS TX band at a frequency offset of ≥ 800 kHz, and with a power level 30 dB below the power level of the wanted signal.

The intermodulation products shall meet the requirements in subclause 4.7.2.

4.7.2 Intra BTS intermodulation attenuation

In a BTS intermodulation may be caused by combining several RF channels or amplification of multiple carriers to feed a single antenna, or when operating them in the close vicinity of each other.

i) The BTS shall be configured with each transmitter operating at the maximum allowed power, with a full complement of transceivers and with modulation applied.

The requirement specified for the multicarrier BTS shall apply for all supported configurations of the multicarrier BTS independently of the number of active carriers, assuming equal power distribution between all carriers, and independently of the modulation type.

ii) For the measurement in the transmit band the equipment shall be operated at equal and minimum carrier frequency spacing as well as with the carriers distributed across the declared maximum Base Station RF bandwidth as described in 3GPP TS 51.021 [18], specified for the BSS configuration under test.

iii) For the measurement in the receive band the equipment shall be operated with such a channel configuration that at least 3rd order intermodulation products fall into the receive band.

4.7.2.1 GSM 400, GSM 900, DCS 1800

a) Requirements for BTS except multicarrier BTS

All the following requirements relate to frequency offsets from the uppermost and lowermost carriers. The peak hold value of intermodulation components over a timeslot, shall not exceed -70 dBc or -36 dBm, whichever is the less stringent, for frequency offsets between 6 MHz and the edge of the relevant Tx band measured in a 300 kHz bandwidth. 1 in 100 timeslots may fail this test by up to a level of 10 dB. For offsets between 600 kHz to 6 MHz the requirements and the measurement technique is that specified in subclause 4.2.1.

The other requirements of subclause 4.3.2 in the band 9 kHz to 12,75 GHz shall still be met.

b) Requirements for multicarrier BTS

In case of the multicarrier BTS class, the average power measured in a 600 kHz band centered at the centre frequency of intermodulation components over a timeslot shall not exceed -70 dBc or -36 dBm if maximum power per carrier exceeds 33 dBm else -41 dBm, or the requirements specified in subclause 4.2.1, whichever is less stringent, for frequency offsets between 0.6 MHz from the outermost carrier and 10 MHz outside the edge of the relevant Tx band. In addition in a 600 kHz band centered at the centre frequencies of the third order intermodulation components the power of the intermodulation components may increase up to -60 dBc or -36 dBm, whichever is less stringent. The measurement bandwidth for both the carrier and the intermodulation products is 300 kHz for offsets larger than 6 MHz, 100 kHz for offsets between 1.8 and 6 MHz and 30 kHz for offsets below 1.8 MHz.

For multicarrier BTS the intermodulation products shall never exceed -16 dBm, measured in 100 kHz bandwidth, as defined in ITU-R Recommendation SM.329, s4.3 and Annex 7.

The other requirements of subclause 4.3.2 in the band 9 kHz to 12,75 GHz shall still be met.

4.7.2.2 MXM 850 and MXM 1900

The following requirements apply to MXM 850 and MXM 1900 BTSs which include ANSI-136 [TIA/EIA-136-C] 30 kHz carriers, in addition to the 200 kHz carriers specified in the present document. All the following requirements relate

to frequency offsets from the uppermost and lowermost carriers. The average value of intermodulation components, for frequency offsets > 1,2 MHz to the edge of the relevant Tx band, shall not exceed:

- a) -60 dBc, measured in a 30 kHz bandwidth, relative to the average power of the 30 kHz channel carrier, measured in a 30 kHz bandwidth, using normal power averaging (per [TIA/EIA-136-C] part 280), and
- b) -60 dBc, measured in a 200 kHz bandwidth, relative to the 200 kHz carrier average power, measured in a 300 kHz bandwidth and averaged over a timeslot.

In addition to the requirements of this section, the MXM 850 BTS and MXM 1900 BTS shall also comply with the applicable limits for spurious emissions established by the FCC rules for public mobile services [FCC Part 22, Subpart H] and FCC rules for wideband PCS services [FCC Title 47 CFR Part 24] respectively.

NOTE 1: In some areas, to avoid uncoordinated system impacts, it may be beneficial to use a more stringent value. -70 dBc rms is suggested.

NOTE 2: For testing reasons, a MXM 1900 normal BTS fulfilling the PCS 1900 normal BTS requirements or a MXM 850 normal BTS fulfilling GSM 850 normal BTS requirements in this subclause may be considered fulfilling the requirements for MXM 1900 normal BTS or MXM 850 normal BTS respectively.

4.7.2.3 GSM 700, GSM 850 and PCS 1900

a) Requirements for BTS except multicarrier BTS

All the following requirements relate to frequency offsets from the uppermost and lowermost carriers. For frequency offsets > 1,8 MHz to the edge of the relevant Tx band, measured in 300 kHz bandwidth the average value of intermodulation components over a timeslot shall not exceed -70 dBc relative to the per carrier power or -46 dBm, whichever is the less stringent. For offsets between 600 kHz and 1,8 MHz, the measurement technique and requirements are those specified in subclause 4.2.1, except for offsets between 1,2 MHz and 1,8 MHz, where the value of intermodulation components shall not exceed the requirements in subclause 4.2.1 or -70 dBc whichever less stringent.

The other requirements of subclause 4.3.2 in the band 9 kHz to 12,75 GHz shall still be met.

In regions where additional protection between uncoordinated systems is required by national regulatory agencies, the intermodulation components for frequency offsets > 1,2 MHz may be up to -60 dBc, if not violating the national regulation requirements.

b) Requirements for multicarrier BTS

In case of the multicarrier BTS class, the average power measured in a 600 kHz band centered at centre frequency of intermodulation components over a timeslot shall not exceed -70 dBc or -36 dBm if maximum power per carrier exceeds 33 dBm else -41 dBm, or the requirements specified in subclause 4.2.1, whichever is less stringent, for frequency offsets between 0.6 MHz from the outermost carrier and 10 MHz outside the edge of the relevant Tx band. In addition, in a 600 kHz band centered at the centre frequencies of the third order intermodulation components the power of the intermodulation components may increase up to -60 dBc or -36 dBm, whichever is less stringent. The measurement bandwidth for both the carrier and the intermodulation products is 300 kHz for offsets larger than 6 MHz, 100 kHz for offsets between 1.8 and 6 MHz and 30 kHz for offsets below 1.8 MHz. The intermodulation products shall never exceed -16 dBm, measured in 100 kHz bandwidth, as defined in ITU-R Recommendation SM.329, sub-clause 4.3 and Annex 7.

c) Additional requirements for all BTS

The PCS 1900, GSM 850 and GSM 700 BTS shall also comply with the applicable limits for spurious emissions established by the FCC rules for wideband PCS services [FCC Title 47 CFR Part 24], FCC rules for public mobile services [FCC Part 22, Subpart H] and FCC rules for miscellaneous wireless communication services [FCC Part 27, Subpart C] respectively, or similar national requirements with comparable limits and rules.

4.7.3 Void

4.7.4 Mobile PBX (GSM 900 only)

In a mobile PBX intermodulation may be caused when operating transmitters in the close vicinity of each other. The intermodulation specification for mobile PBXs (GSM 900 only) shall be that stated in subclause 4.7.2.

5 Receiver characteristics

In this clause, the requirements are given in terms of power levels at the antenna connector of the receiver. Equipment with integral antenna may be taken into account by converting these power level requirements into field strength requirements, assuming a 0 dBi gain antenna. This means that the tests on equipment on integral antenna will consider fields strengths (E) related to the power levels (P) specified, by the following formula (derived from the formula $E = P + 20\log F_{(\text{MHz})} + 77,2$):

assuming F = 405 MHz	:	E (dB μ V/m) = P (dBm) + 129,3	for T-GSM 380 and T-GSM 410;
assuming F = 460 MHz	:	E (dB μ V/m) = P (dBm) + 130,5	for GSM 400;
assuming F = 722 MHz	:	E (dB μ V/m) = P (dBm) + 134,4	for GSM 710;
assuming F = 770 MHz	:	E (dB μ V/m) = P (dBm) + 134,9	for GSM 750;
assuming F = 831 MHz	:	E (dB μ V/m) = P (dBm) + 135,6	for T-GSM 810;
assuming F = 859 MHz	:	E (dB μ V/m) = P (dBm) + 135,9	for GSM 850;
assuming F = 925 MHz	:	E (dB μ V/m) = P (dBm) + 136,5	for GSM 900;
assuming F = 1 795 MHz	:	E (dB μ V/m) = P (dBm) + 142,3	for DCS 1 800;
assuming F = 1 920 MHz	:	E (dB μ V/m) = P (dBm) + 142,9	for PCS 1 900.

Static propagation conditions are assumed in all cases, for both wanted and unwanted signals. For subclauses 5.1 and 5.2, values given in dBm are indicative, and calculated assuming a 50 ohms impedance.

NOTE: From a system perspective the over the air antenna performance is relevant. To determine the MS over the air performance the Total Radiated Sensitivity has been defined. Its definition can be found in 3GPP TS 25.144, and a test method is specified in 3GPP TS 34.114.

5.1 Blocking characteristics

5.1.1 Definitions of applicable frequency ranges

The blocking characteristics of the receiver are specified separately for in-band and out-of-band performance as identified in the following tables.

Table 5.1-1a Definition of in-band and out-of-band frequency range – 900 MHz band

Frequency band	Frequency range (MHz)			
	GSM 900 MS	GSM 900 BTS ^(M)	E-GSM 900 BTS ^(M)	R-GSM 900 BTS
in-band	915 - 980	870 - 925	860 - 925	856 - 921
out-of-band (a)	0,1 - < 915	0,1 - < 870	0,1 - < 860	0,1 - < 856
out-of-band (b)	N/A	N/A	N/A	N/A
out-of band (c)	N/A	N/A	N/A	N/A
out-of band (d)	> 980 - 12,750	> 925 - 12,750	> 925 - 12,750	> 921 - 12,750

Note: Columns applicable to MSR are marked ^(M)

Table 5.1-1b Definition of in-band and out-of-band frequency range – 810 MHz band

Frequency band	Frequency range (MHz) T-GSM 810	
	MS	BTS
in-band	831 to 886	786 to 831
out-of-band (a)	0,1 - <831	0,1 - <786
out-of-band (b)	N/A	N/A
out-of band (c)	N/A	N/A
out-of band (d)	> 886 - 12,750	> 831 - 12,750

Table 5.1-1c Definition of in-band and out-of-band frequency range – 1800 MHz band

Frequency band	Frequency range (MHz) DCS 1 800	
	MS	BTS ^{M)}
in-band	1 785 - 1 920	1 690 - 1 805
out-of-band (a)	0,1 - 1705	0,1 - < 1 690
out-of-band (b)	> 1 705 - < 1 785	N/A
out-of band (c)	> 1 920 - 1 980	N/A
out-of band (d)	> 1 980 - 12,750	> 1 805 - 12,750

Note: Columns applicable to MSR are marked ^{M)}

Table 5.1-1d Definition of in-band and out-of-band frequency range – 1900 MHz band

Frequency band	Frequency range (MHz)	
	PCS 1 900 MS	PCS 1 900 & MXM 1900 BTS ^{M)}
in-band	1910 - 2010	1830 - 1930
out-of-band (a)	0,1 - < 1830	0,1 - < 1830
out-of-band (b)	1830 - < 1910	N/A
out-of band (c)	> 2010 - 2070	N/A
out-of band (d)	> 2070 - 12,750	> 1930 - 12,750

Note: Columns applicable to MSR BS are marked ^{M)}

Table 5.1-1e Definition of in-band and out-of-band frequency range – 850 MHz band

Frequency band	Frequency range (MHz)	
	GSM 850 MS	GSM 850 & MXM 850 BTS ^{M)}
in-band	849 - 914	804 - 869
out-of-band (a)	0,1 - < 849	0,1 - < 804
out-of-band (b)	N/A	N/A
out-of band (c)	N/A	N/A
out-of band (d)	> 914 - 12,750	> 869 - 12,750

Note: Columns applicable to MSR BS are marked ^{M)}

Table 5.1-1f Definition of in-band and out-of-band frequency range – 400 MHz band

Frequency band	Frequency range (MHz)			
	GSM 450		GSM 480	
	MS	BTS	MS	BTS
in-band	457,6 – 473,6	444,4 – 460,4	486,0 – 502,0	472,8 – 488,8
out-of-band (a)	0,1 - < 457,6	0,1 - < 444,4	0,1 - < 486,0	0,1 - < 472,8
out-of-band (b)	N/A	N/A	N/A	N/A
out-of band (c)	N/A	N/A	N/A	N/A
out-of band (d)	> 473,6 - 12,750	> 460,4 - 12,750	> 502,0 - 12,750	> 488,8 - 12,750

Table 5.1-1g Definition of in-band and out-of-band frequency range – T-GSM 400 MHz band

Frequency band	Frequency range (MHz)			
	T-GSM 380		T-GSM 410	
	MS	BTS	MS	BTS
in-band	389.6 – 405.6	374.4 – 390.4	419.6 – 435.6	404.4 – 420.4
out-of-band (a)	0.1 - < 390.4	0.1 - < 374.4	0.1 - < 420.4	0.1 - < 404.4
out-of-band (b)	N/A	N/A	N/A	N/A
out-of band (c)	N/A	N/A	N/A	N/A
out-of band (d)	> 405.6 - 12,750	> 390.4 - 12,750	> 435.6 - 12,750	> 420.4 - 12,750

NOTE: Although the T-GSM 380 and T-GSM 410 bands are 10 MHz wide, because a transition band of at least 2 MHz is needed, a maximum allocation is limited to approximately 8 MHz within the 10 MHz band. The allocated frequencies may be selected from any part of the band consistent with this transition band.

Table 5.1-1h Definition of in-band and out-of-band frequency range – 700 MHz band

Frequency band	Frequency range (MHz) GSM 710		Frequency range (MHz) GSM 750	
	MS	BTS	MS	BTS
	in-band	716 - 766	678 - 728	727 - 777
out-of-band (a)	0,1 - < 716	0,1 - < 678	0,1 - < 727	0,1 - < 762
out-of-band (b)	N/A	N/A	N/A	N/A
out-of band (c)	N/A	N/A	N/A	N/A
out-of band (d)	> 766- 12,750	> 728 - 12,750	> 777- 12,750	> 813 - 12,750

5.1.2 Requirements for MS.

The reference sensitivity performance as specified in tables 1, 1a, 1c, and 1e, adjusted by the correction factors of table 6.2-4, shall be met when the following signals are simultaneously input to the receiver:

- for all MS, a useful signal, modulated with the relevant supported modulation (GMSK or 8-PSK) at frequency f_0 , 3 dB above the reference sensitivity level or input level for reference performance, whichever applicable, as specified in subclause 6.2;
- a continuous, static sine wave signal at a level as in the table below and at a frequency (f) which is an integer multiple of 200 kHz.

with the following exceptions, called spurious response frequencies:

- a) GSM 900 MS, GSM 850 MS and GSM 700 MS: in band, for a maximum of six occurrences (which if grouped shall not exceed three contiguous occurrences per group);

DCS 1 800 and PCS 1 900 MS: in band, for a maximum of twelve occurrences (which if grouped shall not exceed three contiguous occurrences per group);

GSM 400 MS: in band, for a maximum of three occurrences;

- b) out of band, for a maximum of 24 occurrences (which if below f_0 and grouped shall not exceed three contiguous occurrences per group).

where the above performance shall be met when the continuous sine wave signal (f) is set to a level of 70 dB μ V (emf) (i.e. -43 dBm).

NOTE: For testing reasons, a MXM 1900 normal BTS fulfilling the PCS 1900 normal BTS requirements in this paragraph may be considered fulfilling the requirements for MXM 1900 normal BTS.

5.1.3 Requirements for BTS

The reference sensitivity performance as specified in tables 1, 1a, 1b and 1d, adjusted by the correction factors of table 6.2-4, shall be met when the following signals are simultaneously input to the receiver:

- for BTS including multicarrier BTS equipped with multicarrier receiver on all frequency bands except normal BTS and multicarrier BTS on the GSM 700 and GSM 850 bands, and MXM 850 and MXM 1900 normal BTS, a useful signal, modulated with the relevant supported modulation (GMSK or 8-PSK), at frequency f_0 , 3 dB above the reference sensitivity level or input level for reference performance, whichever applicable, as specified in subclause 6.2. In case of multicarrier BTS equipped with multicarrier receiver the requirements, including the requirements in note 2 of table 5.1-2a, also apply when up to the maximum number of supported useful, modulated input signals with equal power level, at least separated by minimum carrier frequency spacing, is simultaneously received within the declared maximum Base Station RF bandwidth;
- for normal BTS and multicarrier BTS equipped with multicarrier receiver on the GSM 700 and GSM 850 bands and MXM 850 and MXM 1900 normal BTS, a useful signal, modulated with the relevant supported modulation (GMSK or 8-PSK), symbol rate and specified pulse shaping filter, at frequency f_0 , 1 dB above the reference sensitivity level or input level for reference performance, whichever applicable, as specified in subclause 6.2. In case of multicarrier BTS equipped with multicarrier receiver the requirements, including the requirements in note 2 of table 5.1-2a, also apply when up to the maximum number of supported useful, modulated input signals with equal power level, at least separated by minimum carrier frequency spacing, is simultaneously received within the declared maximum Base Station RF bandwidth;
- a continuous, static sine wave signal at a level as in the table 5.1-2a below and at a frequency (f) which is an integer multiple of 200 kHz. For normal BTS and multicarrier BTS on the GSM 700 and GSM 850 bands, and MXM 850 and MXM 1900 normal BTS at inband frequency offsets $\geq 3\ 000$ kHz this signal is GMSK modulated by any 148-bit sequence of the 511-bit pseudo random bit sequence, defined in CCITT Recommendation O.153 fascicle IV.4,

with the following exceptions, called spurious response frequencies:

- a) GSM 900 BTS, GSM 850 BTS, GSM 700 BTS, MXM 850 BTS,: in band, for a maximum of six occurrences (which if grouped shall not exceed three contiguous occurrences per group);
DCS 1 800, PCS 1 900 BTS and MXM 1900 BTS: in band, for a maximum of twelve occurrences (which if grouped shall not exceed three contiguous occurrences per group);
GSM 400 BTS: in band, for a maximum of three occurrences;
- b) out of band, for a maximum of 24 occurrences (which if below f_0 and grouped shall not exceed three contiguous occurrences per group).

where the above performance shall be met when the continuous sine wave signal (f) is set to a level of 70 dB μ V (emf) (i.e. -43 dBm).

If more than one wanted signal frequency is considered, the maximum number of allowed occurrences for the spurious response frequencies applies separately to each wanted signal frequency.

NOTE: For testing reasons, a MXM 1900 normal BTS fulfilling the PCS 1900 normal BTS requirements in this paragraph may be considered fulfilling the requirements for MXM 1900 normal BTS.

5.1.4 Signal levels of blocking signal

Table 5.1-2a Blocking signal level requirements

Frequency band	GSM 400, T-GSM 810, P-, E- and R-GSM 900								DCS 1 800 & PCS 1 900					
	other MS		small MS (Note 2)		BTS except multicarrier BTS		Multicarrier BTS (Note 3), (Note 5)		MS		BTS except multicarrier BTS		Multicarrier BTS (Note 3), (Note 5)	
	dBµV (emf)	dBm	dBµV (emf)	dBm	dBµV (emf)	dBm	dBµV (emf)	dBm	dBµV (emf)	dBm	dBµV (emf)	dBm	dBµV (emf)	dBm
in-band														
600 kHz $\leq f-f_0 < 800$ kHz	75	-38	70	-43	87	-26	78	-35	70	-43	78	-35	78	-35
800 kHz $\leq f-f_0 < 1,6$ MHz	80	-33	70	-43	97	-16	97	-16	70	-43	88	-25	88	-25
1,6 MHz $\leq f-f_0 < 3$ MHz	90	-23	80	-33	97	-16	97	-16	80	-33	88	-25	88	-25
3 MHz $\leq f-f_0 $	90	-23	90	-23	100	-13	97	-16	87	-26	88	-25	88	-25
out-of-band (a) (Note 4)	113	0	113	0	121	8	98	-15	113	0	113	0	98	-15
(b)	-	-	-	-	-	-	-	-	101	-12	-	-	-	-
(c)	-	-	-	-	-	-	-	-	101	-12	-	-	-	-
(d) (Note 4)	113	0	113	0	121	8	98	-15	113	0	113	0	98	-15

NOTE 1: f refers to the interfering blocker signal and f_0 refers to the wanted signal being considered. In case of more than one wanted signal being considered f_0 refers to each wanted signal.

NOTE 2: For definition of small MS, see subclause 1.1.

NOTE 3: In case of the multicarrier BTS class with multicarrier receiver, the inband requirements for frequency offsets $800 \text{ kHz} \leq |f-f_0|$ and blocking signal levels higher than -25 dBm, the performance shall be met X dB above the reference sensitivity level or input level for reference performance, whichever applicable, as specified in subclause 6.2 where X is

- 8 dB for blocking signal levels below -20 dBm, and
- 12 dB for blocking signal levels above -20 dBm.

The relaxed values for the multicarrier BTS class are not applicable for GSM-R usage.

The requirements for multicarrier BTS apply to multicarrier BTS with multicarrier receiver.

NOTE 4: These are general co-existence requirements. When co-location capability is declared for any band(s), applicable BTS requirements, are defined in table 5.1-5.

NOTE 5: For MSR BS the requirements for multicarrier BTS with multicarrier receiver apply.

The following exceptions to the level of the sine wave signal (f) in the above table shall apply:

Table 5.1-2b Exceptions to Blocking requirements

for E-GSM MS, in the band 905 MHz to 915 MHz	-5 dBm
for R-GSM 900 MS, in the band 880 MHz to 915 MHz	-5 dBm
for R-GSM 900 small MS, in the band 876 MHz to 915 MHz	-7 dBm
for GSM 450 small MS, in the band 450,4 MHz to 457,6 MHz	-5 dBm
for GSM 480 small MS, in the band 478,8 MHz to 486 MHz	-5 dBm
for T-GSM 810 small MS, in the band 811 MHz to 821 MHz	-5 dBm
for GSM 900 and E-GSM 900 BTS, in the band 925 MHz to 935 MHz	0 dBm ^{M)}
for R-GSM 900 BTS at offsets $600 \text{ kHz} \leq \text{abs}(f-f_0) < 3 \text{ MHz}$, in the band 876 MHz to 880 MHz	Level reduced by 5 dB
NOTE: Exceptions applicable to MSR BS are marked ^{M)}	

The following table gives the figures for the small MS for the T-GSM 380 and T-GSM 410 bands:

Table 5.1-3 Blocking requirements for T-GSM bands – MS

Frequency band	T-GSM 380 and T-GSM 410 small MS	
	dB μ V (emf)	dBm
in-band		
600 kHz $\leq f-f_0 < 800$ kHz	70	-43
800 kHz $\leq f-f_0 < 1,6$ MHz	70	-43
1,6 MHz $\leq f-f_0 < 3$ MHz	80	-33
3 MHz $\leq f-f_0 $	90	-23
out-of-band		
(a)	90	-23
(b)	-	-
(c)	-	-
(d)	90	-23

Table 5.1-4 Blocking requirements for GSM 700 band, GSM 850 band and PCS 1900 band including MXM BTS

Frequency band	GSM 850 & GSM 700 MS		GSM 850 & MXM 850 & GSM 700 BTS except multicarrier BTS		GSM 850 & & MXM 850 & GSM 700 BTS except multicarrier BTS ^{M)}		MXM 1900 BTS except multicarrier BTS		MXM 1900 BTS multicarrier BTS	
	dB μ V (emf)	dBm	dB μ V (emf)	dBm	dB μ V (emf)	dBm	dB μ V (emf)	dBm	dB μ V (emf)	dBm
in-band										
600 kHz $\leq f-f_0 < 800$ kHz	70	-43	76	-37	76	-37	70	-43	70	-43
800 kHz $\leq f-f_0 < 1,6$ MHz	70	-43	78	-35	78	-35	75	-38	75	-38
1,6 MHz $\leq f-f_0 < 3$ MHz	80	-33	80	-33	80	-33	80	-33	80	-33
3 MHz $\leq f-f_0 $	90	-23	80	-33	80	-33	80	-33	80	-33
out-of-band										
(a) (Note 1)	113	0	121	8	98	-15	113	0	98	-15
(b)	-	-	-	-	-	-	-	-	-	-
(c)	-	-	-	-	-	-	-	-	-	-
(d) (Note 1)	113	0	121	8	98	-15	113	0	98	-15

NOTE 1: These are general co-existence requirements. When co-location capability is declared for any band(s), applicable BTS requirements are defined in table 5.1-5.

NOTE 2: Requirements applicable to MSR BS are in columns marked ^{M)}

If the multicarrier BTS, operating in any of the defined frequency bands, is declared as capable of co-locating with BTS in another frequency band the following requirements apply:

Table 5.1-5 Blocking requirement for when co-located with BS in other frequency bands

For co-locating with BTS	Frequency band	Blocking signal level					
		BTS except multicarrier BTS				Multicarrier BTS	
		GSM 400, 900, 700, 850 and MXM 850		DCS 1800, PCS 1900 and MXM 1900			
		dB μ V (emf)	(dBm)	dB μ V (emf)	(dBm)	dB μ V (emf)	(dBm)
GSM 900	921 – 960 MHz	121	+8	113	0	129	+16
DCS 1800	1805 – 1880 MHz	121	+8	113	0	129	+16
GSM 400	460.4 – 467.6 MHz and 488.8 – 496.0 MHz.	121	+8	113	0	129	+16
PCS 1900 & MXM 1900	1930 – 1990 MHz	121	+8	113	0	129	+16
GSM 850 & MXM 850	869 - 894 MHz	121	+8	113	0	129	+16
GSM 700	728 – 746 MHz and 747 – 763 MHz ^(Note 2)	121	+8	113	0	129	+16
T-GSM 810	851 – 866 MHz	121	+8	113	0	129	+16
E-UTRA/FDD Band 20	832 – 862 MHz	121	+8	113	0	129	+16
E-UTRA/TDD Band 39	1880 – 1920 MHz ^(Note 1)	121	+8	113	0	129	+16
UTRA/TDD Band a)	1900 – 1920 MHz and 2010 – 2025 MHz	121	+8	113	0	129	+16
UTRA/FDD Band 1	2110 – 2170 MHz	121	+8	113	0	129	+16
E-UTRA/TDD Band 40	2300 – 2400 MHz	121	+8	113	0	129	+16
UTRA TDD Band d) or E-UTRA Band 38	2570-2620 MHz	121	+8	113	0	129	+16
E-UTRA/FDD Band 7	2620-2690 MHz	121	+8	113	0	129	+16
Note 1:	Only if regionally required						
Note 2:	Except for a BTS operating in 747-756 MHz band, these requirements do not apply when the interfering signal falls within the uplink operating band or in the 10 MHz immediately outside the uplink operating band. For a BTS operating in 747-756 MHz band band the requirements do not apply when the interfering signal falls within the frequency range 768-797 MHz.						
Note 3:	For MSR BS the requirements for Multicarrier BTS are applicable.						

5.1.5 Micro- and pico-BTS

The blocking characteristics of the micro-BTS receiver are specified for in-band and out-of-band performance. The out-of-band blocking remains the same as a normal BTS and the in-band blocking performance shall be no worse than in the table below.

Table 5.1-6 Blocking requirements for micro and pico BTS– levels of interfering signal

Frequency band	GSM 900, GSM 850, GSM 850 and GSM 700 micro and pico-BTS				DCS 1 800, PCS 1900 and GSM 1900 micro and pico-BTS			
	M1 (dBm)	M2 (dBm)	M3 (dBm)	P1 (dBm)	M1 (dBm)	M2 (dBm)	M3 (dBm)	P1 (dBm)
in-band								
600 kHz $\leq f-f_0 < 800$ kHz	-31	-26	-21	-34	-40	-35	-30	-41
800 kHz $\leq f-f_0 < 1,6$ MHz	-21	-16	-11	-34	-30	-25	-20	-41
1,6 MHz $\leq f-f_0 < 3$ MHz	-21	-16	-11	-26	-30	-25	-20	-31
3 MHz $\leq f-f_0 $	-21	-16	-11	-18	-30	-25	-20	-23

The blocking performance for the pico-BTS attempts, for the scenario of a close proximity uncoordinated MS, to balance the impact due to blocking by the MS with that due to wideband noise overlapping the wanted signal.

5.2 AM suppression characteristics

5.2.1 Requirements for MS

The reference sensitivity performance as specified in tables 1, 1a, 1c and 1e, adjusted by the correction factors of table 6.2-4, shall be met when the following signals are simultaneously input to the receiver.

- A useful signal, modulated with the relevant supported modulation (GMSK or 8-PSK) and symbol rate, at frequency f_0 , 3 dB above the reference sensitivity level or input level for reference performance, whichever applicable, as specified in subclause 6.2.
- A single frequency (f), in the relevant receive band, $|f-f_0| > 6$ MHz, which is an integer multiple of 200 kHz, a GSM TDMA signal modulated in GMSK and by any 148-bit sequence of the 511-bit pseudo random bit sequence, defined in CCITT Recommendation O.153 fascicle IV.4, at a level as defined in table 5.2-6. The interferer shall have one timeslot active and the frequency shall be at least 2 channels separated from any identified spurious response. The transmitted bursts shall be synchronized to but delayed in time between 61 and 86 bit periods relative to the bursts of the wanted signal.

NOTE: When testing this requirement, a notch filter may be necessary to ensure that the co-channel performance of the receiver is not compromised.

5.2.2 Requirements for BTS

The reference sensitivity performance as specified in tables 1, 1a, 1b and 1d, adjusted by the correction factors of table 6.2-4, shall be met when the following signals are simultaneously input to the receiver.

- A useful signal, modulated with the relevant supported modulation (GMSK or 8-PSK), at frequency f_0 , 3 dB above the reference sensitivity level or input level for reference performance, whichever applicable, as specified in subclause 6.2. In case of multicarrier BTS equipped with multicarrier receiver the requirements also apply when up to the maximum number of supported useful, modulated (GMSK or 8PSK) input signals, at least separated by minimum carrier frequency spacing, with equal power level is simultaneously received within the declared maximum Base Station RF bandwidth.
- A single frequency (f), in the relevant receive band, $|f-f_0| > 6$ MHz, which is an integer multiple of 200 kHz, a GSM TDMA signal modulated in GMSK and by any 148-bit sequence of the 511-bit pseudo random bit sequence, defined in CCITT Recommendation O.153 fascicle IV.4, at a level as defined in table 5.2-6. The interferer shall have one timeslot active and the frequency shall be at least 2 channels separated from any

identified spurious response. The transmitted bursts shall be synchronized to but delayed in time between 61 and 86 bit periods relative to the bursts of the wanted signal.

NOTE: When testing this requirement, a notch filter may be necessary to ensure that the co-channel performance of the receiver is not compromised.

Table 5.2-6 Requirements for AM suppression

	MS (dBm)	BTS ^{M)} (dBm)	Micro and pico-BTS			
			M1 (dBm)	M2 (dBm)	M3 (dBm)	P1 (dBm)
GSM 400	-31	-31	**	**	**	**
GSM 900	-31	-31	-34	-29	-24	-21
GSM 850	-31	-31	-34	-29	-24	-21
MXM 850	-	-33	-34	-29	-24	-21
GSM 700	-31	-31	-34	-29	-24	-21
DCS 1 800	-31	-35	-33	-28	-23	-26
PCS 1 900	-31	-35	-33	-28	-23	-26
MXM 1900	-	-35	-33	-28	-23	-26

NOTE 1: ** These BTS types are not defined.
NOTE 2: Requirements applicable to MSR BS are in columns marked ^{M)}.

5.3 Intermodulation characteristics

5.3.1 Requirements for MS

The reference sensitivity performance as specified in tables 1, 1a, 1c and 1e, adjusted by the correction factors of table 6.2-4, shall be met when the following signals are simultaneously input to the receiver:

- a useful signal, modulated with the relevant supported modulation (GMSK or 8-PSK) at frequency f_0 , 3 dB above the reference sensitivity level or input level for reference performance, whichever applicable, as specified in subclause 6.2;
- a continuous, static sine wave signal at frequency f_1 and a level of 70 dB μ V (emf) (i.e. -43 dBm):
 - for small MSs on the GSM 400, GSM 900, GSM 850 and GSM 700 frequency bands, and DCS 1 800 and PCS 1 900 MS this value is relaxed to 64 dB μ V (emf) (i.e. -49 dBm);
 - for the DCS 1 800 class 3 MS this value is relaxed to 68 dB μ V (emf) (i.e. -45 dBm);
- any 148-bits subsequence of the 511-bits pseudo-random sequence, defined in CCITT Recommendation O.153 fascicle IV.4 GMSK modulating a signal at frequency f_2 , and a level of 70 dB μ V (emf) (i.e. -43 dBm):
 - for small MSs on the GSM 400, GSM 900 GSM 850 and GSM 700 frequency bands, and DCS 1 800 and PCS 1 900 MS this value is relaxed to 64 dB μ V (emf) (i.e. -49 dBm);
 - for the DCS 1 800 class 3 MS this value is relaxed to 68 dB μ V (emf) (i.e. -45 dBm);

such that $f_0 = 2f_1 - f_2$ and $|f_2 - f_1| = 800$ kHz.

NOTE: For subclauses 5.2 and 5.3 instead of any 148-bits subsequence of the 511-bits pseudo-random sequence, defined in CCITT Recommendation O.153 fascicle IV.4, it is also allowed to use a more random pseudo-random sequence.

5.3.2 Requirements for BTS

The reference sensitivity performance as specified in tables 1, 1a, 1b and 1d, adjusted by the correction factors of table 6.2-4, shall be met when the following signals are simultaneously input to the receiver:

- a useful signal, modulated with the relevant supported modulation (GMSK, 8-PSK), symbol rate and specified pulse shaping filter, at frequency f_0 , 3 dB above the reference sensitivity level or input level for reference performance, whichever applicable, as specified in subclause 6.2;

- a continuous, static sine wave signal at frequency f_1 and a level of 70 dB μ V (emf) (i.e. -43 dBm):
 - for DCS 1 800, PCS 1 900 and MXM 1900 BTS this value is relaxed to 64 dB μ V (emf) (i.e. -49 dBm);
- any 148-bits subsequence of the 511-bits pseudo-random sequence, defined in CCITT Recommendation O.153 fascicle IV.4 GMSK modulating a signal at frequency f_2 , and a level of 70 dB μ V (emf) (i.e. -43 dBm):
 - and DCS 1 800, PCS 1 900 and MXM 1900 BTS this value is relaxed to 64 dB μ V (emf) (i.e. -49 dBm);

such that $f_0 = 2f_1 - f_2$ and $|f_2 - f_1| = 800$ kHz.

NOTE: For subclauses 5.2 and 5.3 instead of any 148-bits subsequence of the 511-bits pseudo-random sequence, defined in CCITT Recommendation O.153 fascicle IV.4, it is also allowed to use a more random pseudo-random sequence.

5.4 Spurious emissions

The spurious emissions for a BTS receiver, measured in the conditions specified in subclause 4.3.1, shall be no more than:

- 2 nW (-57 dBm) in the frequency band 9 kHz to 1 GHz;
- 20 nW (-47 dBm) in the frequency band 1 GHz to 12.75 GHz.

NOTE: For radiated spurious emissions for the BTS, the specifications currently only apply to the frequency band 30 MHz to 4 GHz. The specification and method of measurement outside this band are under consideration.

6 Transmitter/receiver performance

This clause aims at specifying the receiver performance, taking into account that transmitter errors must not occur, and that the transmitter shall be tested separately (see subclause 4.6). All the values given are valid if any of the features: discontinuous transmission (DTx), discontinuous reception (DRx), or slow frequency hopping (SFH) are used or not. The received power levels under multipath fading conditions given are the mean powers of the sum of the individual paths.

a) MS conditions

In order to assess the error rate performance that is described in this clause it is required for a mobile equipment to have a "loop back" facility by which the equipment transmits back the same information that it decoded, in the same mode. This facility is specified in 3GPP TS 44.014. In this clause power levels are given also in terms of field strength, assuming a 0 dBi gain antenna, to apply for the test of MS with integral antennas.

For MS single antenna receiver is always applied.

The requirements specified in this clause shall be met by a MS in CTS mode. In particular the requirement of subclause 6.6 on frequency hopping performance shall be met by a MS performing CTS frequency hopping (as specified in 3GPP TS 45.002 subclause 6.2).

The requirements for the receiver performance in non-static channels with 16QAM, 32QAM and QPSK modulations are specified for training sequence 6 (TSC-6, as defined in 3GPP TS 45.002).

In case of VAMOS mode, one of the *VAMOS subchannels* (see 3GPP TS 45.001) shall use training sequence 5 from TSC set 1 (and is referred to as *VAMOS subchannel 1*) and the other *VAMOS subchannel* shall use training sequence 5 from TSC set 2 (and is referred to as *VAMOS subchannel 2*). The requirements for the receiver performance for speech and control channels in VAMOS mode shall be met on VAMOS subchannel 1 and VAMOS subchannel 2 when the values of SCPIR_DL specified in tables 1s, 1t, 1u, 2aa and 2ab are used for the AQPSK signal.

b) BTS conditions

In the case of base transceiver stations the values apply for measurement at the connection with the antenna of the BTS, including any external multicoupler.

The Rx performance requirements of BTS for modulation schemes using higher symbol rate are based on input signals using wide pulse shaping filter unless otherwise stated. When the wanted input signal is such a signal, it is called Wanted signal Wide.

When the wanted input signal for BTS is using the higher symbol rate with narrow pulse shaping filter, it is called Wanted signal Narrow.

For channels with higher symbol rate the requirements for BTS for non-static propagation conditions are specified with RX diversity with two antennas applied and without RX diversity in the cases where the BTS has only one antenna port. The RX diversity requirements are specified for no correlation or gain imbalance between the two receive branches.

The requirements for the receiver performance in non-static channels with 16QAM, 32QAM and QPSK modulations are specified for training sequence 6 (TSC-6, as defined in 3GPP TS 45.002).

For speech and control channels in VAMOS mode, the requirements for BTS are specified only for non-static propagation conditions. These requirements are with RX diversity with two antennas with no correlation or gain imbalance between the two receive branches.

Unless explicitly stated, the requirements specified for GMSK modulated channels are applicable only for channels that are not in VAMOS mode.

In case of VAMOS mode, one of the *VAMOS subchannels* shall use training sequence 5 from TSC set 1 (and is referred to as *VAMOS subchannel 1*) and the other *VAMOS subchannel* shall use training sequence 5 from TSC set 2 (and is referred to as *VAMOS subchannel 2*). For the cases where SCPIR is not equal to 0 dB, the *VAMOS subchannel 2* shall have lower power than *VAMOS subchannel 1*. The requirements for the receiver performance for speech and control channels in *VAMOS mode* in tables 1v and 2ac are applicable for both *VAMOS subchannels* (see 3GPP TS 45.001).

In case of multicarrier BTS equipped with multicarrier receiver, the stated performance at each receiver antenna port connected to a multicarrier receiver shall be achieved for any of the wanted input signals at the specified power level when receiving up to the maximum supported number of wanted signals at equal power within the declared maximum Base Station RF bandwidth at the receiver antenna connector. The stated performance shall be achieved for requirements specifying an input level of each wanted signal up to and including -40 dBm. For requirements specifying a higher input level of each wanted signal, the stated performance applies for the total peak input level to the multicarrier BTS equipped with multicarrier receiver being not greater than the peak level when receiving a single wanted carrier for the same requirement. The stated performance shall be achieved provided that the frequency spacing between each wanted signal and each other signal that is not a dedicated interferer for that wanted signal is at least 600 kHz.

NOTE: Minimum receiver performance requirements for multicarrier base station declared as multistandard radio base station are defined in Annex P.

6.1 Nominal Error Rates (NER)

This subclause describes the transmission requirements in terms of error rates in nominal conditions i.e. without interference. The relevant propagation conditions appear in annex C.

6.1.1 GMSK modulation

6.1.1.1 General performance requirements

Under the following propagation conditions and with an input level of 20 dB above the reference sensitivity level, the chip error rate, equivalent to the bit error rate of the non protected bits (e.g., TCH/FS class II, TCH/AHS class II or CS-4) shall have the following limits:

- static channel: $BER \leq 10^{-4}$;
- EQ50 channel: $BER \leq 3 \%$;

except for GSM 400, where the following limits applies:

- static channel: $BER \leq 10^{-4}$;
- EQ100 channel: $BER \leq 3\%$;

and for GSM 700, where the following limits applies:

- static channel: $BER \leq 10^{-4}$;
- EQ60 channel: $BER \leq 3\%$.

6.1.1.2 Requirements for MS

The performance in 6.1.1.1 shall be maintained up to -40 dBm input level for static and multipath conditions.

This performance shall also be maintained by the MS under frequency hopping conditions, for input levels up to -40 dBm in timeslots on the C0 carrier, with equal input levels in timeslots on non C0 carriers up to 30 dB less than on the C0 carrier.

NOTE: This scenario may exist when BTS downlink power control and frequency hopping are used.

For static conditions, a bit error rate of 10^{-3} shall also be maintained by the MS under frequency hopping conditions, for input levels on the C0 carrier of up to -15 dBm for GSM 400, GSM 900, GSM 850 and GSM 700, -23 dBm for DCS 1 800 and PCS 1 900, with equal input levels on non C0 carriers, up to 30 dB less than on the C0 carrier.

Furthermore, for static conditions, a bit error rate of 10^{-3} shall be maintained

- up to -15 dBm for GSM 400, GSM 900, GSM 850, GSM 700 MS,
- up to -23 dBm for DCS 1 800 and PCS 1 900 MS.

6.1.1.3 Requirements for BTS

This performance shall be maintained up to -40 dBm input level for static and multipath conditions.

Furthermore, for static conditions, a bit error rate of 10^{-3} shall be maintained up to

- -15 dBm for GSM 400, GSM 900, GSM 850, MXM 850 and GSM 700 BTS excluding multicarrier BTS equipped with multicarrier receiver,
- -18 dBm for GSM 400, GSM 700, GSM 850 and E-GSM 900 for multicarrier BTS equipped with multicarrier receiver,
- -23 dBm for DCS 1 800, PCS 1 900, MXM 1900 BTS including multicarrier BTS.

For the pico-BTS the nominal error rates need only be met in the static channel.

For pico-BTS, for static conditions, a bit error rate of 10^{-3} shall be maintained with input levels up to -5 dBm for GSM 900, GSM 850 MXM 850 and GSM 700, and -14 dBm for DCS 1 800, PCS 1 900 and MXM 1900.

6.1.2 QPSK/8-PSK modulation

6.1.2.1 Requirements for MS

For static propagation conditions, the chip error rate, equivalent to the bit error rate of the uncoded data bits shall have the following limits for input levels specified below:

- MS: $BER \leq 10^{-4}$ for levels ≥ -82 dBm.

This performance shall be maintained for MS, up to -40 dBm input level. The low level limit for other equipment shall be adjusted according to correction table 6.2-4 in subclause 6.2.

NOTE 1: Uncoded data bits refer to the encrypted bits of a burst, extracted by the receiver without any signal processing improvement from encoding/decoding of the signal.

This performance shall also be maintained by the MS under frequency hopping conditions, for input levels up to -40 dBm in timeslots on the C0 carrier, with equal input levels in timeslots on non C0 carriers up to 30 dB less than on the C0 carrier.

NOTE 2: This scenario may exist when BTS downlink power control and frequency hopping are used.

Furthermore, a bit error rate of 10^{-3} shall be maintained by MS for input levels up to -26 dBm.

For static conditions, a bit error rate of 10^{-3} shall also be maintained by the MS under frequency hopping conditions, for input levels on the C0 carrier of up to -26 dBm at QPSK or 8-PSK, with equal input levels on non C0 carriers, up to 30 dB less than on the C0 carrier.

In addition, when the frequency of the input QPSK or 8-PSK modulated signal is randomly offset, on a burst-by-burst basis, by the maximum frequency error specified in 3GPP TS 45.010 (for MS the pico-BTS frequency error in subclause 5.1 applies), the performance shall fulfil the following limits for Static channel:

- for input levels specified below up to -40 dBm:
 - GSM 400, GSM 700, GSM 850 and GSM 900 MS: $BER \leq 10^{-4}$ for levels ≥ -82 dBm;
 - DCS 1800 and PCS 1900 MS: $BER \leq 10^{-3}$ for levels ≥ -82 dBm.

For each burst, the sign of the frequency offset is chosen according to a 511-bit pseudo-random sequence, defined in ITU-T Recommendation O.153. This is also valid for consecutive timeslots in a multislots MS.

For other equipment the low signal level limit shall be adjusted according to correction table 6.2-4 in subclause 6.2.

6.1.2.2 Requirements for BTS

The RX performance requirements of BTS for modulation schemes using higher symbol rate apply to all specified pulse shaping filter used for the input signal.

For static propagation conditions, the chip error rate, equivalent to the bit error rate of the uncoded data bits shall have the following limits for input levels specified below:

- BTS including the multicarrier BTS class: $BER \leq 10^{-4}$ for levels ≥ -84 dBm;

This performance shall be maintained for normal BTS, up to -40 dBm input level. The low level limit for other equipment shall be adjusted according to correction table 6.2-4 in subclause 6.2.

NOTE 1: Uncoded data bits refer to the encrypted bits of a burst, extracted by the receiver without any signal processing improvement from encoding/decoding of the signal.

Furthermore, a bit error rate of 10^{-3} shall be maintained by BTS for input levels up to -26 dBm.

For pico-BTS, for static conditions, a bit error rate of 10^{-3} shall be maintained with input levels up to -16 dBm for GSM 900; GSM 850 MXM 850 and GSM 700, and -17 dBm for DCS 1800, PCS 1900 and MXM 1900.

For micro-BTS, the maximum input level shall be adjusted according to the correction table 6.2-4 for reference sensitivity level in subclause 6.2. In addition, for GSM 850, MXM 850, GSM 700 and GSM 900 the limits shall be reduced by 5 dB.

In addition, when the frequency of the input QPSK or 8-PSK modulated signal is randomly offset, on a burst-by-burst basis, by the maximum frequency error specified in 3GPP TS 45.010 (for BTS the MS frequency error in subclause 6.1 applies), the performance shall fulfil the following limits for Static channel:

- for input levels specified below up to -40 dBm:
 - GSM 400, MXM 850, GSM 850, GSM 700 and GSM 900 normal BTS: $BER \leq 10^{-4}$ for levels ≥ -84 dBm;
 - GSM 850 and GSM 900 multicarrier BTS class: $BER \leq 10^{-4}$ for levels ≥ -84 dBm;
 - DCS 1800, PCS 1900 and MXM 1900 normal BTS: $BER \leq 10^{-4}$ for levels ≥ -84 dBm;

- DCS 1800 and PCS 1900 multicarrier BTS class: $BER \leq 10^{-4}$ for levels ≥ -84 dBm;

For each burst, the sign of the frequency offset is chosen according to a 511-bit pseudo-random sequence, defined in ITU-T Recommendation O.153. This is also valid for consecutive timeslots in a multislot MS.

For other equipment the low signal level limit shall be adjusted according to correction table 6.2-4 in subclause 6.2.

6.1.3 16-QAM/32-QAM modulation

6.1.3.1 Requirements for MS

For static propagation conditions, the chip error rate, equivalent to the bit error rate of the uncoded data bits shall have the following limits for input levels specified below:

Normal symbol rate

- MS: $BER \leq 10^{-4}$ for levels ≥ -80 dBm.

Higher symbol rate

- MS: $BER \leq 10^{-4}$ for levels ≥ -77 dBm.

This performance shall be maintained for MS, up to -40 dBm input level. The low level limit for other equipment shall be adjusted according to correction table 6.2-4 in subclause 6.2.

NOTE 1: Uncoded data bits refer to the encrypted bits of a burst, extracted by the receiver without any signal processing improvement from encoding/decoding of the signal.

This performance shall also be maintained by the MS under frequency hopping conditions, for input levels up to -40 dBm in timeslots on the C0 carrier, with equal input levels in timeslots on non C0 carriers up to 30 dB less than on the C0 carrier.

NOTE 2: This scenario may exist when BTS downlink power control and frequency hopping are used.

Furthermore, a bit error rate of 10^{-3} shall be maintained by MS for input levels up to -29 dBm.

For static conditions, a bit error rate of 10^{-3} shall also be maintained by the MS under frequency hopping conditions, for input levels on the C0 carrier of up to -29 dBm at 16-QAM or 32-QAM, with equal input levels on non C0 carriers, up to 30 dB less than on the C0 carrier.

For other equipment the low signal level limit shall be adjusted according to correction table 6.2-4 in subclause 6.2

6.1.3.2 Requirements for BTS

The RX performance requirements of BTS for modulation schemes using higher symbol rate apply to all specified, pulse shaping filter used for the input signal.

For static propagation conditions, the chip error rate, equivalent to the bit error rate of the uncoded data bits shall have the following limits for input levels specified below:

Normal symbol rate

- BTS including multicarrier BTS class: $BER \leq 10^{-4}$ for levels ≥ -84 dBm;

Higher symbol rate

- BTS including multicarrier BTS class: $BER \leq 10^{-4}$ for levels ≥ -78 dBm;

This performance shall be maintained up to -40 dBm input level. The low level limit for other equipment shall be adjusted according to correction table 6.2-4 in subclause 6.2.

NOTE: Uncoded data bits refer to the encrypted bits of a burst, extracted by the receiver without any signal processing improvement from encoding/decoding of the signal.

Furthermore, a bit error rate of 10^{-3} shall be maintained by BTS for input levels up to -29 dBm.

For pico-BTS, for static conditions, a bit error rate of 10^{-3} shall be maintained with input levels up to -19 dBm for GSM 900; GSM 850 MXM 850 and GSM 700, and -20 dBm for DCS 1800, PCS 1900 and MXM 1900.

For micro-BTS, the maximum input level shall be adjusted according to the correction table 6.2-4 for reference sensitivity level in subclause 6.2. In addition, for GSM 850, MXM 850, GSM 700 and GSM 900 the limits shall be reduced by 5 dB.

For other equipment the low signal level limit shall be adjusted according to correction table 6.2-4 in subclause 6.2.

6.2 Reference sensitivity level

6.2.1 Circuit-switched channels

i) The reference sensitivity performance in terms of frame erasure, bit error, or residual bit error rates (whichever appropriate) is specified in table 1, according to the type of channel and the propagation condition. . The performance requirements for GSM 400 and GSM 700 systems are as for GSM 900 in table 1, except that the GSM 400 MS speed is doubled from that of GSM 900, e.g. TU50 becomes TU100, and the GSM 700 MS speed is increased by a factor of 1.2, e.g. TU50 becomes TU60.

NOTE: For conformance testing purposes using requirements at double speed is considered sufficient to verify MS behaviour at realistic speeds. This applies for packet channels and reference interference performance as well.

The actual sensitivity level is defined as the input level for which this performance is met. The actual sensitivity level shall be less than a specified limit, called the reference sensitivity level. The reference sensitivity level for GMSK modulated signals shall be:

Table 6.2-1a Reference sensitivity level for MS

GSM 400 MS	for GSM 400 small MS	-102 dBm
	for other GSM 400 MS	-104 dBm
GSM 900 MS	for GSM 900 small MS	-102 dBm
	for other GSM 900 MS	-104 dBm
GSM 850 MS	for GSM 850 small MS	-102 dBm
	for other GSM 850 MS	-104 dBm
GSM 700 MS	for GSM 700 small MS	-102 dBm
	for other GSM 700 MS	-104 dBm
DCS 1 800 MS	for DCS 1 800 class 1 or class 2 MS	-100 / -102 dBm *
	for DCS 1 800 class 3 MS	-102 dBm
PCS 1 900 MS	for PCS 1 900 class 1 or class 2 MS	-102 dBm
	for other PCS 1 900 MS	-104 dBm

Table 6.2-1b Reference sensitivity level for BTS

GSM 400 BTS	for normal BTS	-104 dBm
GSM 900 BTS, GSM 700 BTS, GSM 850 BTS ^{M)} MXM 850	for normal BTS	-104 dBm ^{M)}
	for micro BTS M1	-97 dBm
	for micro BTS M2	-92 dBm
	for micro BTS M3	-87 dBm
	for pico BTS P1	-88 dBm
DCS 1 800 BTS	for normal BTS	-104 dBm ^{M)}
	for micro BTS M1	-102 dBm
	for micro BTS M2	-97 dBm
	for micro BTS M3	-92 dBm
	for pico BTS P1	-95 dBm
PCS 1 900 BTS MXM 1900	for normal BTS	-104 dBm ^{M)}
	for micro BTS M1	-102 dBm
	for micro BTS M2	-97 dBm
	for micro BTS M3	-92 dBm
	for pico BTS P1	-95 dBm
NOTE: The values marked by ^{M)} apply to BTS declared as Multistandard radio Base Station for respective frequency band		

* For DCS 1 800 class 1 and class 2 MS, the -102 dBm level shall apply for the reference sensitivity performance as specified in table 1 for the normal conditions defined in Annex D and -100 dBm level shall be used to determine all other MS performances.

ii) For GMSK modulated speech channels for wideband AMR, and for 8-PSK modulated speech channels for AMR, associated control channels and inband signalling, the minimum input signal level for which the reference performance shall be met is specified in table 1f and 1g respectively for normal BTS, according to the type of channel and the propagation condition. The reference performance shall be:

Table 6.2-2 Reference performance for Wideband-AMR and 8-PSK modulated AMR channels

-	for speech channels (TCH/WFS _y)	FER : ≤ 1%
-	for speech channels (O-TCH/AHS _y , O-TCH/WFS _y , O-TCH/WHS _y)	FER : ≤ 1%
-	for fast associated control channels (O-FACCH/F, O-FACCH/H)	FER : ≤ 5%
-	for inband signalling channels (TCH/WFS-INB, O-TCH/AHS-INB, O-TCH/WFS-INB, O-TCH/WHS-INB)	FER : ≤ 0,5%
-	for EVSIDUR and EVRFR	FER : ≤ 1%

where y denotes the codec rate. All other requirements in tables 1f and 1g shall be fulfilled at this input level for reference performance.

For other equipment than normal BTS, the levels shall be corrected by the values in table 6.2-4. Furthermore, for all classes of MS supporting 8-PSK speech channels, an additional +2 dB adjustment applies for 8-PSK modulated speech channels.

For Enhanced circuit-switched channels (ECSD), the minimum input signal level for which the reference performance shall be met is specified in table 1d and 1e, according to the modulation, type of channel and the propagation condition. The performance requirements for GSM 400 and GSM 700 systems are as for GSM 900 in table 1d and 1e, except that the GSM 400 MS speed is doubled from that of GSM 900, e.g. TU50 becomes TU100, and the GSM 700 MS speed is increased by a factor of 1.2, e.g. TU50 becomes TU60.

The reference performance shall be:

Table 6.2-3 Reference performance for Enhanced circuit-switched channels

-	for data channels (E-TCH/F), transparent services (T)	:	BER \leq 0,1%
-	for data channels (E-TCH/F), non-transparent services (NT))	:	BLER \leq 10%
-	for fast associated control channel (E-FACCH)	:	FER \leq 5%

where BLER refers to radio block (data block of 20 ms length, corresponding to 1368 coded bits, to be interleaved over a number of burst according to 3GPP TS 45.003).

The levels are given for normal BTS and MS separately. For other equipment, the levels shall be corrected by the values in the table 6.2-4.

6.2.1a Reference performance in VAMOS mode

The reference performance in *VAMOS Mode*, shall be

- For full rate speech channels (TCH/FS, TCH/AFS_x, TCH/EFS, TCH/WFS_x) FER: \leq 1 %
- For half rate speech channels (TCH/HS, TCH/AHS_x) FER: \leq 1 %
- For signalling channels (FACCH/F, FACCH/H, SACCH) FER: \leq 5 %

For speech channels in *VAMOS Mode*, and their associated control channels, the minimum input signal level for which the reference performance shall be met is specified in table 1s, 1t, 1u and 1v according to the propagation condition and type of equipment. The levels are given for VAMOS I MS, VAMOS II MS and normal BTS separately. For other BTS equipment, the levels in table 1v shall be corrected by the values in table 6.2-4. The performance requirements for GSM 400 and GSM 700 systems are as for GSM 900 in table 1s for VAMOS I MS, 1t and 1u for VAMOS II MS and 1v for BTS, except that the GSM 400 MS speed is doubled from that of GSM 900, e.g. TU50 becomes TU100, and the GSM 700 MS speed is increased by a factor of 1.2, e.g. TU50 becomes TU60.

In addition for speech channels the residual class Ib BER and residual class II BER performance shall not exceed the specified values in table 1s, 1t, 1u and 1v at the corresponding signal level in dBm.

The reference performance for the repeated associated control channel performance in *VAMOS mode* shall be according to subclause 6.2.4.

6.2.2 Packet-switched channels

i) For packet switched channels, the minimum input signal level for which the reference performance shall be met in case of normal symbol-rate, Basic Transmit-Time-Interval (BTTI) and no Piggy-backed ACK/NACK reporting (PAN) used, is specified in table 1a for GMSK modulated input signals, tables 1b and 1c for 8-PSK modulated input signals (convolutional coding), table 1l for input signals modulated by 8-PSK (turbo coding), tables 1k and 1l for input signals modulated by 16-QAM and 32-QAM respectively, according to the type of channel and the propagation condition. In case higher symbol rate, Basic Transmit-Time-Interval (BTTI) and no Piggy-backed ACK/NACK reporting (PAN) are used, the minimum input signal level for which the reference performance shall be met, is specified in table 1m and 1n for input signals modulated by QPSK or 16-QAM or 32-QAM respectively, according to the type of channel and the propagation condition. For Reduced Transmit-Time-Interval (RTTI) the minimum performance requirements are the same as for Basic Transmit-Time-Interval (BTTI) on a static channel. When Piggy-backed ACK/NACK reporting

(PAN) is used, the minimum performance requirements of tables 1o and 1p apply. The minimum input signal level for which the reference performance shall be met for PAN is specified in table 1q and 1r. Tables 1p and 1q apply to BTS for input signals with wide pulse shaping filter in the case of higher symbol rate. The performance requirements for GSM 400 and GSM 700 systems are as for GSM 900, except that the GSM 400 MS speed is doubled from that of GSM 900, e.g. TU50 becomes TU100, and the GSM 700 MS speed is increased by a factor of 1.2, e.g. TU50 becomes TU60. The levels are given for normal BTS for GMSK modulated signals. For QPSK, 8-PSK, 16-QAM and 32-QAM modulated signals, the required levels are given for normal BTS and MS separately. The levels shall be corrected by the following values:

Table 6.2-4 Correction factor of performance requirements for different equipments

<u>MS, GMSK modulated signals</u>		
-	for DCS 1 800 class 1 or class 2 MS	+2/+4 dB**
-	for DCS 1 800 class 3 MS	+2 dB
-	for GSM 400 small MS, GSM 900 small MS GSM 850 small MS and GSM 700 small MS	+2 dB
-	for other GSM 400, GSM 900 MS and GSM 850 MS and GSM 700 MS	0 dB
	for PCS 1900 class 1 or class 2 MS	+2 dB
	for other PCS 1900 MS	0 dB
<u>MS, QPSK, 8-PSK, 16-QAM and 32-QAM modulated signals</u>		
-	for GSM 400, GSM 900, GSM 850 and GSM 700 small MS	0 dB
-	for other GSM 400, GSM 900, GSM 850 and GSM 700 MS	-2 dB
-	for DCS 1 800 and PCS 1900 class 1 or class 2 MS	0 dB
-	for other DCS 1 800 and PCS 1900 MS	-2 dB
<u>BTS</u>		
-	for normal BTS	0 dB
-	for GSM 900, GSM 850, MXM 850 and GSM 700 micro BTS M1	+7 dB
-	for GSM 900, GSM 850, MXM 850 and GSM 700 micro BTS M2	+12 dB
-	for GSM 900, GSM 850, MXM 850 and GSM 700 micro BTS M3	+17 dB
-	for GSM 900, GSM 850, MXM 850 and GSM 700 pico BTS P1	+16 dB
-	for DCS 1 800, PCS 1900 and MXM 1900 micro BTS M1	+2 dB
-	for DCS 1 800, PCS 1900 and MXM 1900 micro BTS M2	+7 dB
-	for DCS 1 800, PCS 1900 and MXM 1900 micro BTS M3	+12 dB
-	for DCS 1 800, PCS 1900 and MXM 1900 pico BTS P1	+9 dB

** For DCS 1 800 class 1 and class 2 MS, a correction offset of +2dB shall apply for the reference sensitivity performance as specified in table 1a for the normal conditions defined in Annex D and an offset of +4 dB shall be used to determine all other MS performances.

The reference performance shall be:

Table 6.2-5 Reference performance for Packet channels

-	for packet data channels (PDCH)	BLER ≤ 10% unless otherwise stated
-	for uplink state flags (USF)	BLER ≤ 1%
-	for packet random access channels (PRACH),	BLER ≤ 15%
-	for Piggy-backed ACK/NACK report (PAN)	PAN error rate ≤ 5%

where BLER is the Block Error Rate, referring to all erroneously decoded data blocks including any headers, stealing flags, parity bits as well as any implicit information in the training sequence. For PDCH the BLER refers to RLC blocks, and hence there can be up to two block errors per 20ms radio block for EGPRS MCS7, MCS8, MCS9, UAS-7, UAS-8, UAS-9, UBS-7, UBS-8, DAS-8, DAS-9, DAS-10, DBS-7 and DBS-8, up to three block errors per radio block for UAS-10, UAS-11, UBS-9, UBS-10, DAS-11, DAS-12, DBS-9 and DBS-10, and up to four block errors per radio block for UBS-11, UBS-12, DBS-11 and DBS-12. The BLER refers to the initial transmission of RLC blocks, i.e. the channel decoding without incremental redundancy. For USF, the BLER only refers to the USF value.

ii) If BTTI USF mode is used when sending downlink data blocks in RTTI configuration and different modulations are used in the two data blocks sent in a 20 ms block period, the USF will be sent with mixed modulation. In this case, the performance of the mixed modulation USF shall meet the less stringent requirement of the two modulations for static propagation conditions according to:

Table 6.2-6 USF performance in mixed modulation

GMSK	USF/MCS-1 to 4	(table 1a)
8PSK	USF/MCS5 to 9	(table 1c)
16QAM (EGPRS2-A)	USF/DAS-8 to 9	(table 1l)
32QAM (EGPRS2-A)	USF/DAS-10 to 12	(table 1l)
QPSK (EGPRS2-B)	USF/DBS-5 to 6	(table 1n)
16QAM (EGPRS2-B)	USF/DBS-7 to 9	(table 1n)
32QAM (EGPRS2-B)	USF/DBS-10 to 12	(table 1n)

For PDCH channels, the performance requirements for some modulation and coding schemes and propagation conditions are specified at higher BLER. Where applicable, the BLER value noted in the respective performance requirement table applies.

6.2.3 Flexible Layer One

For Flexible Layer One (FLO), the minimum input signal level for which the reference performance shall be met is specified in table 1h, according to the type of reference measurement FLO configurations (or TFCs) and the propagation condition. The reference TFCs are specified in Annex K. The performance requirements for GSM 400 and GSM 700 systems are as for GSM 900 in tables 1h, except that the GSM 400 MS speed is doubled from that of GSM 900, e.g. TU50 becomes TU100, and the GSM 700 MS speed is increased by a factor of 1.2, e.g. TU50 becomes TU60.

The reference performance shall be:

Table 6.2-7 Reference performance for FLO channels

-	for reference TFCs 2,3,4 and 5	BLER \leq 1%
-	for reference TFC 1	BLER \leq 5%
-	for reference TFCs 6 and 7	BLER \leq 10%

where BLER is the Block Error Rate, referring to all erroneously decoded transport blocks (except those without CRC protection), In all the radio packets for which the TFCI, or any implicit information in the training sequence, is decoded incorrectly, all the transport blocks (with CRC protection) will be counted in error.

The reference performance levels for FLO shall be corrected according to the values in the table 6.2-4, but with an additional correction of +2 dB on 8-PSK channels for all MS.

6.2.4 Repeated associated control channel performance

For Repeated Downlink FACCH and Repeated SACCH (see 3GPP TS 44.006), the minimum input signal level for which the reference performance shall be met is specified in table 1i, 1s, 1t, 1u and 1v, according to the propagation condition and type of equipment. The performance requirements for GSM 400 and GSM 700 systems are as for GSM 900 in table 1i, 1s, 1t, 1u and 1v, except that the GSM 400 MS speed is doubled from that of GSM 900, e.g. TU50 becomes TU100, and the GSM 700 MS speed is increased by a factor of 1.2, e.g. TU50 becomes TU60.

The reference performance for Repeated Downlink FACCH and Repeated SACCH shall be FER \leq 5%. When calculating FER, a FACCH frame and its repetition or a SACCH frame and its repetition respectively, shall be counted as one frame and a frame erasure shall be counted when neither the FACCH frame nor its repetition or neither the SACCH frame nor its repetition respectively, could be successfully decoded.

The reference performance levels for Repeated Downlink FACCH and Repeated SACCH in table 1i and 1v shall be corrected according to the values in the table 6.2-4.

6.2.5 Enhanced MS receiver performance

i) For a MS indicating support for Downlink Advanced Receiver Performance – phase II Capability (see 3GPP TS 24.008), the minimum input signal level for which the reference performance shall be met is specified in table 1j, according to the propagation condition and type of equipment. The performance requirements for GSM 400 and GSM 700 systems are as for GSM 900 in table 1j, except that the GSM 400 MS speed is doubled from that of GSM 900, e.g. TU50 becomes TU100, and the GSM 700 MS speed is increased by a factor of 1.2, e.g. TU50 becomes TU60.

The reference performance for Downlink Advanced Receiver Performance – phase II, shall be

- For speech channels (TCH/FS, TCH/AFS_x, TCH/AHS_x) FER: ≤ 1 %
- For packet switched channels (PDTCH) BLER: ≤ 10 %

In addition for speech channels the residual class Ib BER and residual class II BER performance shall not exceed the specified values in table 1j at the corresponding signal level in dBm.

The reference sensitivity performance specified above for Downlink Advanced Receiver Performance – phase II need not be met by an MS when it is in a Downlink Dual Carrier configuration (see 3GPP TS 43.064).

ii) For a MS indicating support for TIGHTER Capability (see 3GPP TS 24.008), the minimum input signal levels for which the reference performance shall be met are specified in table 1w, according to the propagation condition. The performance requirements for GSM 400 and GSM 700 systems are as for GSM 900 in table 1w, except that the GSM 400 MS speed is doubled from that of GSM 900, e.g. TU50 becomes TU100, and the GSM 700 MS speed is increased by a factor of 1.2, e.g. TU50 becomes TU60.

The reference performance for Tightened Link Level Performance (TIGHTER) specified in table 1w, shall be

- For speech channels (TCH/FS, TCH/HS, TCH/EFS, TCH/AFS_x, TCH/WFS_x) FER: ≤ 1 % TCH/AHS_x,
- For signalling channels (SCH, FACCH/F, FACCH/H, SDCCH) FER: ≤ 5 %
- For packet switched channels (PDTCH) BLER: ≤ 10 % unless otherwise stated

In addition for speech channels the residual class Ib BER and residual class II BER performance shall not exceed the specified values in table 1w at the corresponding signal level in dBm. The reference sensitivity level in section 6.2.1 shall be applied for TIGHTER MS.

6.2.6 Additional performance conditions

i) The reference sensitivity performance specified above need not be met in the following cases:

- for BTS if the received level on either of the two adjacent timeslots to the wanted exceed the reference sensitivity level for circuit-switched, GMSK-modulated channels by more than 50 dB;
- for MS at the static channel, if the received level on either of the two adjacent timeslots to the wanted exceed the wanted timeslot reference sensitivity level or input level for reference performance, whichever applicable by more than 20 dB;
- for MS on a multislot configuration, if the received level on any of the timeslots belonging to the same multislot configuration as the wanted time slot, exceed the wanted time slot by more than 6 dB.

The interfering adjacent time slots shall be static with valid GSM GMSK signals in all cases. The adjacent timeslot levels, specified above apply to 8-PSK, AQPSK, QPSK, 16-QAM and 32-QAM modulated signals as well.

ii) The requirements for micro-BTS for 8-PSK, QPSK, 16-QAM and 32-QAM modulated input signals in the tables above, assume the same maximum output power in any modulation. For other maximum output power levels, the sensitivity is adjusted accordingly.

iii) The pico-BTS 900 MHz, 1800 MHz, 1900 MHz and 850 MHz shall meet the reference sensitivity performance specified for the static channel. The only other channel that is specified is the TI5 propagation condition and this need only be tested for the no FH case. The performance requirement for GSM 900, GSM 850, GSM 700, DCS 1 800, PCS 1900, MXM 850 and MXM 1900 pico-BTS with the TI5 propagation condition is the same as the TU50 performance requirement for GSM 900. The level of input signal at which this requirement shall be met is 3dB above the level specified above in this sub-clause (in combination with Table 1a, 1b, 1k, 1p and 1q for packet service), for GMSK modulated signals, and 3 dB for 8-PSK modulated signals. For 16-QAM, 32-QAM and QPSK the level of input signal at which the requirement shall be met is 3 dB above the level specified above in this sub-clause (in combination with Table 1k, 1m, 1p and 1q for packet service). In case of higher symbol rate, tables 1p and 1q apply for input signals using wide and narrow pulse shaping filter.

6.3 Reference interference level

6.3.1 GMSK modulated speech channels and associated control channels

The reference interference performance (for cochannel, C/I_c , or adjacent channel, C/I_a) in terms of frame erasure, bit error or residual bit error rates (whichever appropriate) is specified in table 2, according to the type of channel and the propagation condition. The performance requirements for GSM 400 and GSM 700 systems are as for GSM 900 in table 2, except that the GSM 400 MS speed is doubled from that of GSM 900, e.g. TU50 becomes TU100, and the GSM 700 MS speed is increased by a factor of 1.2, e.g. TU50 becomes TU60. The actual interference ratio is defined as the interference ratio for which this performance is met. The actual interference ratio shall be less than a specified limit, called the reference interference ratio. The reference interference ratio shall be, for all types of BTS and all types of MS:

Table 6.3-1 Reference interference ratio requirements – circuit-switched GMSK modulated channels except for Enhanced circuit-switched data, speech and control channels in VAMOS mode and Wideband AMR

-	for cochannel interference	C/I_c	=	9 dB
-	for adjacent (200 kHz) interference	C/I_{a1}	=	-9 dB
-	for adjacent (400 kHz) interference	C/I_{a2}	=	-41 dB
-	for adjacent (600 kHz) interference	C/I_{a3}	=	-49 dB

6.3.2 Co-channel reference interference performance

6.3.2.1 MS requirements

For GMSK modulated channels, packet switched and ECSD and speech channels (AMR-WB), and for 8-PSK modulated channels, packet switched and ECSD and speech channels (AMR and AMR-WB), and for 16-QAM, 32-QAM and QPSK modulated packet switched channels, the minimum interference ratio for which the reference performance for cochannel interference (C/I_c) shall be met is specified in table 2a, 2e and 2j (GMSK), 2c, 2e, 2k, and 2s (8-PSK), 2s, and 2u (16-QAM), 2s, and 2u (32-QAM), respectively, according to the type of channel and the propagation condition, when BTTI and no PAN are used.

For FLO, the minimum interference ratio for which the reference performance for cochannel interference (C/I_c) shall be met is specified in table 2m according to the type of reference TFC and the propagation condition.

For Repeated Downlink FACCH and Repeated SACCH (see 3GPP TS 44.006), the minimum interference ratio for which the reference performance for cochannel interference (C/I_c) shall be met is specified in table 2p according to the propagation condition.

The performance requirements for GSM 400 and GSM 700 systems are as for GSM 900 in table 2a, 2c, 2e, 2j, 2k, 2m, 2o, 2p, 2q, 2s, 2u, except that the GSM 400 MS speed is doubled from that of GSM 900, e.g. TU50 becomes TU100, and the GSM 700 MS speed is increased by a factor of 1.2, e.g. TU50 becomes TU60. The reference performance is the same as defined in subclause 6.2.

For equipment supporting 8-PSK, and for MS indicating support for Downlink Advanced Receiver Performance – phase I (see 3GPP TS 24.008), the applicable requirements in table 2a, 2c, 2e, 2j, 2k, 2m, 2p, 2s, and 2u apply for both GMSK and 8-PSK modulated interfering signals.

For AQPSK modulated speech channels (TCH/HS, TCH/AFS_x, TCH/AHS_x, TCH/EFS, TCH/WFS_x – in downlink), and their associated control channels, the applicable requirements are in tables 2aa for VAMOS I MS and 2ab for VAMOS II MS.

6.3.2.2 BTS requirements

For GMSK modulated channels, packet switched and ECSD and speech channels (AMR-WB), and for 8-PSK modulated channels, packet switched and ECSD and speech channels (AMR and AMR-WB), and for 16-QAM, 32-QAM and QPSK modulated packet switched channels, the minimum interference ratio for which the reference performance for cochannel interference (C/I_c) shall be met is specified in table 2a, 2d and 2j (GMSK), 2b, 2d and 2k, (8-PSK), 2r and 2t (16-QAM), 2t (32-QAM), respectively, according to the type of channel and the propagation condition, when BTTI and no PAN are used.

For FLO, the minimum interference ratio for which the reference performance for cochannel interference (C/I_c) shall be met is specified in table 2m according to the type of reference TFC and the propagation condition.

For Repeated SACCH (see 3GPP TS 44.006), the minimum interference ratio for which the reference performance for cochannel interference (C/I_c) shall be met is specified in table 2p according to the propagation condition.

The performance requirements for GSM 400 and GSM 700 systems are as for GSM 900 in table 2a, 2b, 2d, 2j, 2k, 2m, 2p, 2r, 2t, except that the GSM 400 MS speed is doubled from that of GSM 900, e.g. TU50 becomes TU100, and the GSM 700 MS speed is increased by a factor of 1.2, e.g. TU50 becomes TU60. The reference performance is the same as defined in subclause 6.2.

For equipment supporting 8-PSK, the applicable requirements in table 2a, 2b, 2d, 2j, 2k, 2m, 2p, 2r and 2t apply for both GMSK and 8-PSK modulated interfering signals.

For GMSK modulated speech channels in *VAMOS mode* (TCH/HS, TCH/AFS_x, TCH/AHS_x, TCH/EFS, TCH/WFS_x – in uplink), and their associated control channels, the applicable requirements are in table 2ac.

6.3.3 Adjacent channel reference interference performance

The corresponding interference ratio for adjacent channel interference shall be:

6.3.3.1 Normal symbol rate used

For equipment supporting 8-PSK, the requirements apply for both GMSK and 8-PSK modulated interfering signals.

6.3.3.1.1 MS requirements

Table 6.3-1a Reference interference ratio requirements in adjacent channels for Packet-switched (Normal symbol-rate), Enhanced circuit-switched data, Wideband AMR and 8-PSK modulated AMR channels, speech and associated control channels in *VAMOS mode*, *TIGHTER - MS*

		Modulation of wanted signal				
		GMSK	8-PSK	16-QAM	32-QAM	AQPSK
for adjacent (200 kHz) interference	$C/I_{a1} =$	$C/I_c - 18$ dB, see table 2af for TIGHTER MS	See table 2l for speech, see tables 2g, 2i, 2n and 2w for other channels, see table 2af for TIGHTER MS	See table 2w, see table 2af for TIGHTER MS	See table 2w, see table 2af for TIGHTER MS	See table 2aa and 2ab
for adjacent (400 kHz) interference	$C/I_{a2} =$	$C/I_c - 50$ dB	$C/I_c - 50$ dB	$C/I_c - 48$ dB	$C/I_c - 48$ dB	[Note 1]
for adjacent (600 kHz) interference	$C/I_{a3} =$	$C/I_c - 58$ dB	$C/I_c - 58$ dB			

NOTE 1: The adjacent channel interference @ 400 kHz requirement (C/I_{a2}) does not apply to channels in *VAMOS mode*.

NOTE: The C/I_{a3} figure is given for information purposes and will not require testing. It was calculated for the case of an equipment with an antenna connector, operating at output power levels of +33 dBm and below. Rejection of signals at 600 kHz is specified in subclause 5.1.

For packet switched channels, the requirements for adjacent channel performance in the tables above apply to channels with BTTI and no PAN used.

The values in tables 2g, 2i, 2l, 2n, 2w and 2af, are also valid for GSM 400 with the exception that MS speed is doubled, e.g. TU50 becomes TU100. For GSM 700 the values in tables 2g, 2i, 2l, 2n, 2v, 2w and 2af, are valid with the exception that GSM 700 MS speed is increased by a factor of 1.2, e.g. TU50 becomes TU60.

6.3.3.1.2 BTS requirements

Table 6.3-1b Reference interference ratio requirements in adjacent channels for Packet-switched (Normal symbol-rate), Enhanced circuit-switched data, Wideband AMR and 8-PSK modulated AMR channels, speech and associated control channels in VAMOS mode - BTS

<u>Modulation of wanted signal</u>		<u>GMSK</u>	<u>8-PSK</u>	<u>16-QAM</u>
- for adjacent (200 kHz) interference	C/Ia1 =	C/Ic - 18 dB See table 2ac for channels in VAMOS mode	See table 2l for speech, see tables 2f, 2h, and 2n for other channels	See tables 2v
- for adjacent (400 kHz) interference	C/Ia2 =	C/Ic - 50 dB	C/Ic -50 dB	C/Ic -48 dB
- for adjacent (600 kHz) interference	C/Ia3 =	C/Ic - 58 dB	C/Ic -58 dB	

NOTE 1: The adjacent channel interference @ 400 kHz requirement (C/Ia2) does not apply to channels in VAMOS mode.

NOTE 2: The C/Ia3 figure is given for information purposes and will not require testing. It was calculated for the case of an equipment with an antenna connector, operating at output power levels of +33 dBm and below. Rejection of signals at 600 kHz is specified in subclause 5.1.

For packet switched channels, the requirements for adjacent channel performance in the tables above apply to channels with BTTI and no PAN used.

The values in tables 2f, 2h, 2l, 2n and 2v, are also valid for GSM 400 with the exception that MS speed is doubled, e.g. TU50 becomes TU100. For GSM 700 the values in tables 2f, 2h, 2l, 2n and 2v, are valid with the exception that GSM 700 MS speed is increased by a factor of 1.2, e.g. TU50 becomes TU60.

6.3.3.2 Higher symbol rate used:

The requirements for the adjacent (200 kHz) channel shall be met with an interferer at higher symbol rate, using the same modulation and pulse shaping filter as the wanted signal. For the adjacent (400 kHz) channel the requirements apply for both GMSK and 8-PSK modulated interfering signals.

6.3.3.2.1 MS requirements

Table 6.3-2a Reference interference ratio requirements in adjacent channels for Packet-switched channels (Higher symbol-rate), TIGHTER - MS

<u>Modulation of wanted signal</u>		<u>QPSK</u>	<u>16-QAM</u>	<u>32-QAM</u>	<u>Pulse shaping filter of wanted signal</u>
- for adjacent (200 kHz) interference	C/Ia1 =	See table 2y, for TIGHTER see table 2af	See table 2y, for TIGHTER MS see table 2af	See table 2y, for TIGHTER MS see table 2af	
- for adjacent (400 kHz) interference	C/Ia2 =	C/Ic -[50] dB	C/Ic -[48] dB	C/Ic -[48] dB	Narrow downlink

The requirements for adjacent channel performance in the tables above apply to channels with BTTI and no PAN used.

The values in table 2y and 2af are also valid for GSM 400 with the exception that MS speed is doubled, e.g. TU50 becomes TU100. For GSM 700 the values in table 2y and 2af are valid with the exception that GSM 700 MS speed is increased by a factor of 1.2, e.g. TU50 becomes TU60.

6.3.3.2.2 BTS requirements

In the uplink, different tables apply for the adjacent (200 kHz) channel requirements depending on what pulse shaping filter bandwidth is used.

Table 2x applies to the case of narrow pulse shaping filter.

Table 2z applies to the case of wide pulse shaping filter.

Table 6.3-2b Reference interference ratio requirements in adjacent channels for Packet-switched channels (Higher symbol-rate), - BTS

<u>Modulation of wanted signal</u>	<u>QPSK</u>	<u>16-QAM</u>	<u>32-QAM</u>	<u>Pulse shaping filter of wanted signal</u>
- for adjacent (200 kHz) interference	$C/I_{a1} =$ See tables 2x 2z	See tables 2x 2z	See tables 2x 2z	Narrow Wide
- for adjacent (400 kHz) interference	$C/I_{a2} =$ $C/I_c - 44.5$ dB	$C/I_c - 43$ dB	$C/I_c - 42.5$ dB	Wide uplink

The requirements for adjacent channel performance in the tables above apply to channels with BTTI and no PAN used.

The values in tables 2x and 2z, are also valid for GSM 400 with the exception that MS speed is doubled, e.g. TU50 becomes TU100. For GSM 700 the values in tables 2x and 2z, are valid with the exception that GSM 700 MS speed is increased by a factor of 1.2, e.g. TU50 becomes TU60.

6.3.4 Reference interference performance – signal levels

These specifications apply for a wanted signal input level of 20 dB above the reference sensitivity level listed in table 6.2-1a and table 6.2-1b.

For packet switched and AMR-WB speech, GMSK modulated channels the wanted input signal level shall be: -93 dBm + Ir + Corr, where:

Ir = the interference ratio according to table 2a and table 2j for the packet switched and AMR-WB speech channels respectively

Corr = the correction factor for reference performance according to table 6.2-4.

For 8-PSK modulated speech channels (AMR and AMR-WB), ECSD channels and 8-PSK modulated packet-switched channels, the wanted input signal level shall be: -93 dBm + Ir + Corr, where:

Ir = the interference ratio according to tables 2b, 2c and 2s for packet switched channels, tables 2d and 2e for ECSD and table 2k for speech (AMR and AMR-WB) and associated control channels.

Corr = the correction factor for reference performance according to table 6.2-4.

For QPSK, 16-QAM and 32-QAM modulated packet-switched channels, the wanted input signal level shall be: -93 dBm + Ir + Corr, where:

Ir = the interference ratio according to tables 2t and 2u for QPSK modulated packet switched channels, tables 2r, 2s, 2t and 2u for 16-QAM modulated packet switched and tables 2s, 2t and 2u for 32-QAM modulated packet switched channels.

Corr = the correction factor for reference performance according to table 6.2-4.

For AQPSK modulated speech channels and control channels in downlink, the wanted input signal level shall be: $[-93]$ dBm + Ir, where:

Ir = the interference ratio according to tables 2aa for VAMOS I MS and 2ab for VAMOS II MS for VDTS-1, VDTS-2 and VDTS-3 (see subclause Q.1) for speech and associated control channels in VAMOS mode in downlink.

For GMSK modulated speech channels and control channels in VAMOS mode in uplink, the input signal level of VAMOS subchannel 2 shall be: -93 dBm + Ir + Corr, where:

Ir = the interference ratio according to tables 2ac for VUTS-1, VUTS-3 and VUTS-4 (see subclause Q.2).

Corr = the correction factor for reference performance according to table 6.2-4.

For FLO, the wanted input signal level shall be: -93 dBm + Ir + Corr, where:

Ir = the interference ratio according to table 2m.

Corr = the correction factor for reference performance according to table 6.2-4.

For Repeated Downlink FACCH and Repeated SACCH (see 3GPP TS 44.006), the wanted input signal level shall be: -93 dBm + Ir + Corr, where:

I_r = the interference ratio according to table 2p.

Corr = the correction factor for reference performance according to table 6.2-4.

For all channels specified in table 2ad for TIGHTER MS, the wanted signal level shall be: $-93 \text{ dBm} + I_r + \text{Corr}$, where:

I_r = the interference ratio according to table 2ad

Corr = the correction factor for reference performance according to table 6.2-4.

For adjacent channel performance for packet-switched channels except for the adjacent channel (200 kHz) requirements of EGPRS2 specific channels, the wanted input signal level shall be set to the value calculated using the formulas above for cochannel performance.

For the adjacent channel (200 kHz) requirements of EGPRS2-A packet-switched channels, UAS-7 to 11 and DAS-5 to 12, and EGPRS2-B packet-switched channels, UBS-5 to 12 and DBS-5 to 12, the wanted input signal level shall be: $-75 \text{ dBm} + I_{ar} + \text{Corr}$, where:

I_{ar} = the adjacent channel (200 kHz) interference ratio according to table 2v for UAS-7 to 11, table 2w for DAS-5 to 12, table 2y for DBS-5 to 12 and table 2x and 2z for UBS-5 to 12 respectively.

Corr = the correction factor for reference performance according to table 6.2-4.

For the adjacent channel (200 kHz) requirements of speech and control channels in VAMOS mode in downlink, the wanted input signal level of the AQPSK modulated signal shall be: $[-75] \text{ dBm} + I_{ar}$, where:

I_{ar} = the adjacent channel (200 kHz) interference ratio according to tables 2aa and 2ab for VAMOS I MS and VAMOS II MS respectively for VDTS-4 (see subclause Q.1).

For the adjacent channel (200 kHz) requirements of speech and control channels in VAMOS mode in uplink, the input signal level of the GMSK modulated VAMOS subchannel 2 signal shall be: $-75 \text{ dBm} + I_{ar} + \text{Corr}$, where:

I_{ar} = the adjacent channel (200 kHz) interference ratio according to table 2ac for VUTS-2 (see subclause Q.2).

Corr = the correction factor for reference performance according to table 6.2-4.

For all adjacent channel (200 kHz) requirements specified in table 2af for TIGHTER MS, the wanted signal level shall be: $-75 \text{ dBm} + I_{ar} + \text{Corr}$, where:

I_{ar} = the adjacent channel (200 kHz) interference ratio according to table 2af

Corr = the correction factor for reference performance according to table 6.2-4.

6.3.5 Additional reference interference performance requirements and conditions

If not stated differently, all reference interference specifications in section 6.3 apply only for a random, continuous, GMSK modulated interfering signal.

In case of frequency hopping, the interference and the wanted signals shall have the same frequency hopping sequence. In any case the wanted and interfering signals shall be subject to the same propagation profiles (see annex C), independent on the two channels.

For a GSM 400 MS, a GSM 900 MS, a GSM 850 MS, a GSM 700 MS, a DCS 1 800 MS and a PCS 1 900 MS the reference interference performance according to table 2 and 2j for co-channel interference (C/I_c) shall be maintained for RA500/250/130 propagation conditions if the time of arrival of the wanted signal is periodically alternated by steps of $8 \mu\text{s}$ in either direction. The period shall be 32 seconds (16 seconds with the early and 16 seconds with the late time of arrival alternately).

For pico-BTS, propagation conditions other than static and T15 are not specified and only the no FH case need be tested. The performance requirement for GSM 900, GSM 850, GSM 700, DCS 1 800, PCS 1900, MXM 850 and MXM 1900 pico-BTS with T15 propagation condition is the same as the TU50 no FH (900MHz) performance requirement. The interference ratio at which this requirement shall be met is, for GMSK modulated wanted signals, 4dB above the interference ratio specified above in this sub-clause (in combination with Table 2a for packet service). For 8-PSK modulated wanted signals, the interference ratio for this requirement is 4 dB above the interference ratio specified above in this sub-clause (in combination with Table 2b, 2c, 2d, 2e and 2s for packet service). For 16-QAM, 32-QAM and QPSK modulated wanted signals, the interference ratio for this requirement is 4 dB above the interference ratio specified above in this sub-clause (in combination with Table 2r, 2s, 2t and 2u (16-QAM), and Table 2s, 2t and 2u (32-

QAM), and Table 2t and 2u (QPSK) for packet service). For adjacent channel interference propagation conditions other than TU50 need not be tested. There is an exception in the case of the pico-BTS in that the specified propagation condition is TI5 instead of TU50; the respective test for pico-BTS is described in the paragraph following table 6.3-3 below.

If, in order to ease measurement, a TU50 (no FH) faded wanted signal, and a static adjacent channel interferer are used, the reference interference performance shall be:

Table 6.3-3 Reference interference ratio measurements for GMSK-modulated speech channels - simplified

	GSM 850 & GSM 900 & GSM 700	DCS 1 800 & PCS 1 900
TCH/FS (FER):	10,2 α %	5,1 α %
Class Ib (RBER):	0,72/ α %	0,45/ α %
Class II (RBER):	8,8 %	8,9 %
FACCH (FER):	17,1 %	6,1 %

For pico-BTS, adjacent channel and cochannel interference propagation conditions other than TI5 need not be tested. If, in order to ease adjacent channel measurements, a TI5 (no FH) faded wanted signal, and a static adjacent channel interferer are used, the interference performance shall be the same as that specified above for a TU50 no FH channel (900MHz). The interference ratio at which this performance shall be met is 4dB above the reference interference ratio specified above in this sub-clause.

In addition, MS indicating support for Downlink Advanced Receiver Performance – phase I (see 3GPP TS 24.008) shall fulfil the requirements in table 2o for wanted signals on GMSK modulated channels under TU50 no FH propagation conditions and GMSK modulated interferers for the test scenarios defined in annex L, unless when the MS is assigned a Downlink Dual Carrier configuration (see 3GPP TS 44.060) comprising a total of more than 8 timeslots, in which case, the MS shall only fulfil the requirements at least on all the timeslots that are assigned on the carrier 1 (see 3GPP TS 44.060). The reference performance shall be:

Table 6.3-4 Reference performance for DARP – phase I

For speech channels (TCH/FS, TCH/AFS _x , TCH/AHS _x)	FER:	≤ 1 %
For signalling channels (FACCH/F, SDCCH)	FER:	≤ 5 %
For packet switched channels (PDTCH)	BLER:	≤ 10 %

The values in table 2o are given as the C/I1 ratio, where C is the power level of the wanted signal and I1 is the power level of the dominant co-channel interferer (Co-channel 1, see annex L).

In addition for speech channels the residual class Ib BER and residual class II BER performance shall not exceed the specified values in table 2o at the corresponding C/I1.

A MS indicating support for Downlink Advanced Receiver Performance – phase II Capability (see 3GPP TS 24.008) shall fulfil the requirements in table 2q for the test scenarios defined in annex N. The reference performance shall be:

Table 6.3-5 Reference performance for DARP – phase II

For speech channels (TCH/FS, TCH/AFS _x , TCH/AHS _x)	FER:	≤ 1 %
For packet switched channels (PDTCH)	BLER:	≤ 10 %

The values in table 2q are given as the C/I1 ratio, where C is the power level of the wanted signal and I1 is the power level of the dominant co-channel interferer (Co-channel 1, see annex N).

In addition for speech channels the residual class Ib BER and residual class II BER performance shall not exceed the specified values in table 2q at the corresponding C/I1.

The reference interference performance specified above for Downlink Advanced Receiver Performance – phase II need not be met by an MS when it is in a Downlink Dual Carrier configuration (see 3GPP TS 43.064).

A MS indicating support for TIGHTER Capability (see 3GPP TS 24.008) shall fulfil the requirements in table 2ad for cochannel interference (C/Ic), table 2af for adjacent channel (200 kHz) interference (C/Ia1), and the additional

requirements in table 2ae for wanted signals on GMSK modulated channels for the test scenarios defined in annex L. The reference performance shall be:

Table 6.3-6 Reference performance for TIGHTER

For speech channels (TCH/FS, TCH/HS, TCH/EFS, TCH/AFSx, TCH/AHSx, TCH/WFSx)	FER:	$\leq 1 \%$
For signalling channels (FACCH/F, FACCH/H, SDCCH)	FER:	$\leq 5 \%$
For packet switched channels (PDTCH)	BLER:	$\leq 10 \%$ unless otherwise stated

For equipment supporting 8-PSK, and for MS indicating support for Downlink Advanced Receiver Performance – phase I (see 3GPP TS 24.008), the applicable TIGHTER requirements in table 2ad for TCH/WFSx and PDTCH, and table 2af for TCH/WFSx, PDTCH/CSx, PDTCH/MCSx and PDTCH/DASx apply for both GMSK and 8-PSK modulated interfering signals.

The values in table 2ae are given as the $C/I1$ ratio, where C is the power level of the wanted signal and $I1$ is the power level of the dominant co-channel interferer (Co-channel 1, see annex L).

In addition to table 6.3-6, for speech channels the residual class Ib BER and residual class II BER performance shall not exceed the specified values in table 2ad, 2ae and 2af at the corresponding interference ratio C/Ic , $C/I1$, and $C/Ia1$, respectively.

6.4 Erroneous frame indication performance

- On a speech TCH (TCH/FS, TCH/EFS, TCH/HS, TCH/AFS, TCH/AHS, TCH/WFS, O-TCH/AHS, O-TCH/WFS or O-TCH/WHS) or a SDCCH with a random RF input, of the frames believed to be FACCH, O-FACCH, SACCH, or SDCCH frames, the overall reception performance shall be such that no more than 0,002 % of the frames are assessed to be error free.
- On a speech TCH (TCH/FS, TCH/EFS, TCH/HS, TCH/AFS, TCH/AHS, TCH/WFS, O-TCH/AHS, O-TCH/WFS or O-TCH/WHS) with a random RF input, the overall reception performance shall be such that, on average, less than one undetected bad speech frame (false bad frame indication BFI) shall be measured in one minute.
- On a speech TCH (TCH/FS, TCH/EFS, TCH/HS, TCH/AFS, TCH/AHS, TCH/WFS, O-TCH/AHS, O-TCH/WFS or O-TCH/WHS), when DTX is activated with frequency hopping through C0 where bursts comprising SID frames, SACCH frames and Dummy bursts are received at a level 20 dB above the reference sensitivity level and with no transmission at the other bursts of the TCH, the overall reception performance shall be such that, on average less than one undetected bad speech frame (false bad frame indication BFI) shall be measured in one minute for MS. This performance shall also be met in networks with one of the configurations described in 3GPP TS 45.002 - annex A, excepted combinations #1 and #6 of table A.2.5.1 for which there is no performance requirement.
- On a speech TCH (TCH/FS, TCH/EFS, TCH/HS, TCH/AFS, TCH/AHS, TCH/WFS, O-TCH/AHS, O-TCH/WFS or O-TCH/WHS), when DTX is activated with SID frames and SACCH frames received 20 dB above the reference sensitivity level and with no transmission at the other bursts of the TCH, the overall reception shall be such that, on average, less than one undetected bad speech frame (false bad frame indication BFI) shall be measured in one minute for BTS.
- For a BTS on a RACH or PRACH with a random RF input, the overall reception performance shall be such that less than 0,02 % of frames are assessed to be error free.
- For a BTS on a PRACH with a random RF input, the overall reception performance shall be such that less than 0,02 % of frames are assessed to be error free.
- For an MS assigned a USF on a PDCH with a random RF input or a valid PDCH signal with a random USF not equal to the assigned USF, the overall reception shall be such that the MS shall detect the assigned USF in less than 1% of the radio blocks for GMSK modulated signals, and 1 % for 8-PSK modulated signals, and 1 % for

QPSK, 16-QAM and 32-QAM modulated signals. This requirement shall be met for all input levels up to -40 dBm for GMSK, QPSK, 8PSK, 16QAM and 32QAM modulated signal.

- h) The FER on an SACCH associated to an adaptive speech traffic channel (TCH/AFS, TCH/AHS, TCH/WFS, O-TCH/AHS, O-TCH/WFS or O-TCH/WHS) received at 3 dB below the reference co-channel interference level shall be less than [40%] tested under TU 3 / TU 1.5 propagation conditions.
- i) On a speech TCH (TCH/AFS, TCH/AHS, TCH/WFS, O-TCH/AHS, O-TCH/WFS or O-TCH/WHS), a RATSCCH message, respectively a RATSCCH marker, shall be detected if more than 72% of the bits of the RATSCCH identification field (defined in 3GPP TS 45.003) are matched by the corresponding gross bits of the received frame.

6.5 Random access and paging performance at high input levels

a) MS requirements

Under static propagation conditions with a received input level from 20 dB above the reference sensitivity level

- up to -15 dBm for GSM 400, GSM 700, GSM 850 and GSM900 and
- up to -23 dBm for DCS1800 and PCS 1 900,

the MS FER shall be less than 0,1% for PCH.

b) BTS requirements

Under static propagation conditions with a received input level from 20 dB above the reference sensitivity level

- up to -15 dBm for GSM 400, GSM 700, GSM 850 and GSM900 normal BTS and multicarrier BTS excluding multicarrier BTS equipped with multicarrier receiver,
- up to -16 dBm for GSM400, GSM 850 and GSM900 multicarrier BTS equipped with multicarrier receiver and
- up to -23 dBm for DCS1800 and PCS 1 900, normal BTS and multicarrier BTS

and a single MS sending an access burst, the BTS FER shall be less than 0,5% for RACH.

6.6 Frequency hopping performance under interference conditions

Under the following conditions:

- a useful signal, cyclic frequency hopping over four carriers under static conditions, with equal input levels 20 dB above reference sensitivity level;
- a random, continuous, GMSK-modulated interfering signal on only one of the carriers at a level 10 dB higher than the useful signal.

The FER for TCH/FS shall be less than 5%.

6.7 Incremental Redundancy Performance for EGPRS and EGPRS2 MS

Support for Incremental Redundancy reception is mandatory for all EGPRS capable MSs. In Incremental Redundancy RLC mode soft information from multiple, differently punctured, versions of an RLC data block may be used when decoding the RLC data block. This significantly increases the link performance.

An EGPRS capable MS shall under the conditions stated in the below table 6.7-1 achieve a long-term throughput of 20 kbps per time slot (see note), measured between LLC and RLC/MAC layer.

An EGPRS2 capable MS shall under the conditions stated in the below table 6.7-14 achieve a long-term throughput of 33 kbps per time slot, measured between LLC and RLC/MAC layer

Table 6.7-1 Incremental Redundancy performance

	EGPRS supported	EGPRS2 supported
Required throughput	20,0 kbps per timeslot	33 kbps per timeslot
Propagation conditions	Static, input level -97,0 dBm	Static, input level -94 dBm
Modulation and Coding Scheme	MCS-9	DAS-12
Acknowledgements polling period	32 RLC data blocks	32 RLC data blocks
Roundtrip time	120 ms	120 ms
Number of timeslots	Maximum capability of the MS	Maximum capability of the MS
Transmit window size	Maximum for the MS timeslot capability	Maximum for the MS timeslot capability

NOTE: The requirement for EGPRS corresponds to an equivalent block error rate of approximately 0.66 using the prescribed MCS-9.

Table 1: Reference sensitivity performance for GMSK modulated channels

GSM 850 and GSM 900						
Type of channel		Propagation conditions				
		static	TU50 (no FH)	TU50 (ideal FH)	RA250 (no FH)	HT100 (no FH)
FACCH/H	(FER)	0,1 %	6,9 %	6,9 %	5,7 %	10,0 %
FACCH/F	(FER)	0,1 %	8,0 %	3,8 %	3,4 %	6,3 %
SDCCH	(FER)	0,1 %	13 %	8 %	8 %	12 %
RACH	(FER)	0,5 %	13 %	13 %	12 %	13 %
SCH	(FER)	1 %	16 %	16 %	15 %	16 %
TCH/F14,4	(BER)	10 ⁻⁵	2,5 %	2 %	2 %	5 %
TCH/F9,6 & H4,8	(BER)	10 ⁻⁵	0,5 %	0,4 %	0,1 %	0,7 %
TCH/F4,8	(BER)	-	10 ⁻⁴	10 ⁻⁴	10 ⁻⁴	10 ⁻⁴
TCH/F2,4	(BER)	-	2 10 ⁻⁴	10 ⁻⁵	10 ⁻⁵	10 ⁻⁵
TCH/H2,4	(BER)	-	10 ⁻⁴	10 ⁻⁴	10 ⁻⁴	10 ⁻⁴
TCH/FS	(FER)	0,1 α %	6 α %	3 α %	2 α %	7 α %
	class Ib (RBER)	0,4/ α %	0,4/ α %	0,3/ α %	0,2/ α %	0,5/ α %
	class II (RBER)	2 %	8 %	8 %	7 %	9 %
TCH/EFS	(FER)	< 0,1 %	8 %	3 %	3 %	7 %
	(RBER Ib)	< 0,1 %	0,21 %	0,11 %	0,10 %	0,20 %
	(RBER II)	2,0 %	7 %	8 %	7 %	9 %
TCH/HS	(FER)	0,025 %	4,1 %	4,1 %	4,1 %	4,5 %
	class Ib (RBER, BFI=0)	0,001 %	0,36 %	0,36 %	0,28 %	0,56 %
	class II (RBER, BFI=0)	0,72 %	6,9 %	6,9 %	6,8 %	7,6 %
	(UFR)	0,048 %	5,6 %	5,6 %	5,0 %	7,5 %
	class Ib (RBER, (BFI or UFI)=0)	0,001 %	0,24 %	0,24 %	0,21 %	0,32 %
	(EVSIDR)	0,06 %	6,8 %	6,8 %	6,0 %	9,2 %
	(RBER, SID=2 and (BFI or UFI)=0)	0,001 %	0,01 %	0,01 %	0,01 %	0,02 %
	(ESIDR)	0,01 %	3,0 %	3,0 %	3,2 %	3,4 %
	(RBER, SID=1 or SID=2)	0,003 %	0,3 %	0,3 %	0,21 %	0,42 %
TCH/AFS12.2	(FER)	-	4,9 %	2,4 %	1,4 %	4,5 %
	Class Ib (RBER)	< 0,001 %	1,5 %	1,5 %	1,2 %	2,1 %
TCH/AFS10.2	(FER)	-	2,1 %	0,85 %	0,45 %	1,6 %
	Class Ib (RBER)	< 0,001 %	0,23 %	0,15 %	0,092 %	0,26 %
TCH/AFS7.95	(FER)	-	0,36 %	0,045 %	0,024 %	0,096 %
	Class Ib (RBER)	-	0,11 %	0,032 %	0,02 %	0,06 %
TCH/AFS7.4	(FER)	-	0,41 %	0,069 %	0,028 %	0,13 %
	Class Ib (RBER)	-	0,054 %	0,016 %	0,009 %	0,033 %
TCH/AFS6.7	(FER)	-	0,16 %	0,017 %	< 0,01 % ^(*)	0,026 %
	Class Ib (RBER)	-	0,082 %	0,022 %	0,013 %	0,044 %
TCH/AFS5.9	(FER)	-	0,094 %	< 0,01 % ^(*)	< 0,01 % ^(*)	0,011 %
	Class Ib (RBER)	-	0,014 %	0,001 %	0,001 %	0,003 %
TCH/AFS5.15	(FER)	-	0,07 %	< 0,01 % ^(*)	< 0,01 % ^(*)	< 0,01 % ^(*)
	Class Ib (RBER)	-	0,014 %	< 0,001 %	< 0,001 %	0,002 %
TCH/AFS4.75	(FER)	-	0,029 %	< 0,01 % ^(*)	-	< 0,01 % ^(*)
	Class Ib (RBER)	-	0,005 %	< 0,001 %	< 0,001 %	< 0,001 %
TCH/AFS-INB	(FER)	-	0,034 %	0,013 %	0,006 %	0,019 %
TCH/AFS	(EVSIDUR)	-	0,82 %	0,17 %	0,17 %	0,17 %
TCH/AFS	(EVRFR)	-	0,095 %	0,007 %	0,007 %	0,011 %
TCH/AHS7.95	(FER)	< 0,01 % ^(*)	20 %	20 %	17 %	28 %
	Class Ib (RBER)	0,004 %	2,3 %	2,3 %	2 %	2,9 %
	Class II (RBER)	0,66 %	5 %	5 %	4,7 %	5,7 %

Continued

Table 1 (continued): Reference sensitivity performance for GMSK modulated channels

GSM 850 and GSM 900						
Type of Channel		Propagation conditions				
		Static	TU50 (no FH)	TU50 (ideal FH)	RA250 (no FH)	HT100 (no FH)
TCH/AHS7.4	(FER)	< 0,01 % ^(*)	16 %	16 %	14 %	22 %
	Class Ib (RBER)	< 0,001 % ^(*)	1,4 %	1,4 %	1,1 %	1,8 %
	Class II (RBER)	0,66 %	5,3 %	5,3 %	5 %	6 %
TCH/AHS6.7	(FER)	< 0,01 % ^(*)	9,2 %	9,2 %	8 %	13 %
	Class Ib (RBER)	< 0,001 %	1,1 %	1,1 %	0,93 %	1,5 %
	Class II (RBER)	0,66 %	5,8 %	5,8 %	5,5 %	6,6 %
TCH/AHS5.9	(FER)	-	5,7 %	5,7 %	4,9 %	8,6 %
	Class Ib (RBER)	-	0,51 %	0,51 %	0,42 %	0,73 %
	Class II (RBER)	0,66 %	6 %	6 %	5,7 %	6,8 %
TCH/AHS5.15	(FER)	-	2,5 %	2,5 %	2,2 %	4 %
	Class Ib (RBER)	-	0,51 %	0,51 %	0,43 %	0,78 %
	Class II (RBER)	0,66 %	6,3 %	6,3 %	6 %	7,2 %
TCH/AHS4.75	(FER)	-	1,2 %	1,2 %	1,2 %	1,8 %
	Class Ib (RBER)	-	0,17 %	0,17 %	0,14 %	0,26 %
	Class II (RBER)	0,66 %	6,4 %	6,4 %	6,2 %	7,4 %
TCH/AHS-INB	(FER)	0,013 %	0,72 %	0,64 %	0,53 %	0,94 %
TCH/AHS	(EVSIDUR)	-	1,5 %	1,5 %	2,1 %	1,5 %
TCH/AHS	(EVRFR)	-	0,25 %	0,24 %	0,33 %	0,28 %

DCS 1 800 & PCS 1 900						
Type of channel		Propagation conditions				
		static	TU50 (no FH)	TU50 (ideal FH)	RA130 (no FH)	HT100 (no FH)
FACCH/H	(FER)	0,1 %	7,2 %	7,2 %	5,7 %	10,4 %
FACCH/F	(FER)	0,1 %	3,9 %	3,9 %	3,4 %	7,4 %
SDCCH	(FER)	0,1 %	9 %	9 %	8 %	13 %
RACH	(FER)	0,5 %	13 %	13 %	12 %	13 %
SCH	(FER)	1 %	19 %	19 %	15 %	25 %
TCH/F14,4	(BER)	10 ⁻⁵	2,1 %	2 %	2 %	6,5 %
TCH/F9,6 & H4,8	(BER)	10 ⁻⁵	0,4 %	0,4 %	0,1 %	0,7 %
TCH/F4,8	(BER)	-	10 ⁻⁴	10 ⁻⁴	10 ⁻⁴	10 ⁻⁴
TCH/F2,4	(BER)	-	10 ⁻⁵	10 ⁻⁵	10 ⁻⁵	10 ⁻⁵
TCH/H2,4	(BER)	-	10 ⁻⁴	10 ⁻⁴	10 ⁻⁴	10 ⁻⁴
TCH/FS	(FER)	0,1 α %	3 α %	3 α %	2 α %	7 α %
	class Ib (RBER)	0,4/ α %	0,3/ α %	0,3/ α %	0,2/ α %	0,5/ α %
	class II (RBER)	2 %	8 %	8 %	7 %	9 %
TCH/EFS	(FER)	< 0,1 %	4 %	4 %	3 %	7 %
	(RBER Ib)	< 0,1 %	0,12 %	0,12 %	0,10 %	0,24 %
	(RBER II)	2,0 %	8 %	8 %	7 %	9 %
TCH/HS	(FER)	0,025 %	4,2 %	4,2 %	4,1 %	5,0 %
	class Ib (RBER, BFI=0)	0,001 %	0,38 %	0,38 %	0,28 %	0,63 %
	class II (RBER, BFI=0)	0,72 %	6,9 %	6,9 %	6,8 %	7,8 %
	(UFR)	0,048 %	5,7 %	5,7 %	5,0 %	8,1 %
	class Ib (RBER, (BFI or UFI)=0)	0,001 %	0,26 %	0,26 %	0,21 %	0,35 %
	(EVSIDR)	0,06 %	7,0 %	7,0 %	6,0 %	9,9 %
	(RBER, SID=2 and (BFI or UFI)=0)	0,001 %	0,01 %	0,01 %	0,01 %	0,02 %
	(ESIDR)	0,01 %	3,0 %	3,0 %	3,2 %	3,9 %
	(RBER, SID=1 or SID=2)	0,003 %	0,33 %	0,33 %	0,21 %	0,45 %
TCH/AFS12.2	(FER)	-	2 %	2,0 %	1,3 %	4,6 %
	Class Ib (RBER)	< 0,001 %	1,4 %	1,4 %	1,2 %	2,1 %
TCH/AFS10.2	(FER)	-	0,65 %	0,65 %	0,41 %	1,6 %
	Class Ib (RBER)	< 0,001 %	0,12 %	0,12 %	0,084 %	0,26 %
TCH/AFS7.95	(FER)	-	0,025 %	0,025 %	0,018 %	0,089 %
	Class Ib (RBER)	-	0,023 %	0,023 %	0,016 %	0,061 %
TCH/AFS7.4	(FER)	-	0,036 %	0,036 %	0,023 %	0,13 %
	Class Ib (RBER)	-	0,013 %	0,013 %	0,007 %	0,031 %
TCH/AFS6.7	(FER)	-	< 0,01 % ^(*)	< 0,01 % ^(*)	< 0,01 % ^(*)	0,031 %
	Class Ib (RBER)	-	0,017 %	0,017 %	0,01 %	0,041 %
TCH/AFS5.9	(FER)	-	< 0,01 % ^(*)	< 0,01 % ^(*)	< 0,01 % ^(*)	< 0,01 % ^(*)
	Class Ib (RBER)	-	< 0,001 %	< 0,001 %	< 0,001 %	0,002 %
TCH/AFS5.15	(FER)	-	< 0,01 % ^(*)	< 0,01 % ^(*)	-	< 0,01 % ^(*)
	Class Ib (RBER)	-	< 0,001 %	< 0,001 %	< 0,001 %	0,003 %
TCH/AFS4.75	(FER)	-	< 0,01 % ^(*)	-	-	< 0,01 % ^(*)
	Class Ib (RBER)	-	< 0,001 %	< 0,001 %	< 0,001 %	< 0,001 %
TCH/AFS-INB	(FER)	-	0,011 %	0,011 %	0,006 %	0,021 %
TCH/AFS	(EVSIDUR)	-	0,19 %	0,19 %	0,17 %	0,25 %
TCH/AFS	(EVFR)	-	0,007 %	0,007 %	0,002 %	0,01 %

Continued

Table 1 (concluded): Reference sensitivity performance for GMSK modulated channels

DCS 1 800 & PCS 1 900						
Type of Channel	Propagation conditions					
	Static	TU50 (no FH)	TU50 (ideal FH)	RA130 (no FH)	HT100 (no FH)	
TCH/AHS7.95	(FER)	< 0,01 % ^(*)	20 %	20 %	17 %	27 %
	Class Ib (RBER)	0,004 %	2,3 %	2,3 %	2 %	2,9 %
	Class II (RBER)	0,66 %	5 %	5 %	4,8 %	5,7 %
TCH/AHS7.4	(FER)	< 0,01 % ^(*)	16 %	16 %	13 %	22 %
	Class Ib (RBER)	<0,001 % ^(*)	1,4 %	1,4 %	1,1 %	1,9 %
	Class II (RBER)	0,66 %	5,3 %	5,3 %	5,1 %	6 %
TCH/AHS6.7	(FER)	< 0,01 % ^(*)	9,4 %	9,4 %	7,5 %	13 %
	Class Ib (RBER)	< 0,001 %	1,1 %	1,1 %	0,92 %	1,5 %
	Class II (RBER)	0,66 %	5,8 %	5,8 %	5,5 %	6,6 %
TCH/AHS5.9	(FER)	-	5,9 %	5,9 %	4,6 %	8,5 %
	Class Ib (RBER)	-	0,52 %	0,52 %	0,39 %	0,72 %
	Class II (RBER)	0,66 %	6,1 %	6,1 %	5,8 %	6,8 %
TCH/AHS5.15	(FER)	-	2,6 %	2,6 %	2 %	3,7 %
	Class Ib (RBER)	-	0,53 %	0,53 %	0,4 %	0,76 %
	Class II (RBER)	0,66 %	6,3 %	6,3 %	6,1 %	7,2 %
TCH/AHS4.75	(FER)	-	1,2 %	1,2 %	1,1 %	1,7 %
	Class Ib (RBER)	-	0,18 %	0,18 %	0,13 %	0,25 %
	Class II (RBER)	0,66 %	6,5 %	6,5 %	6,2 %	7,3 %
TCH/AHS-INB	(FER)	0,013 %	0,64 %	0,64 %	0,53 %	0,94 %
TCH/AHS	(EVSIDUR)	-	1,3 %	1,3 %	2,1 %	1,5 %
TCH/AHS	(EVRFR)	-	0,24 %	0,24 %	0,25 %	0,24 %

NOTE 1: The specification for SDCCH applies also for BCCH, AGCH, PCH, SACCH. The actual performance of SACCH, should be better.

NOTE 2: Definitions:
 FER: Frame erasure rate (frames marked with BFI=1)
 UFR: Unreliable frame rate (frames marked with (BFI or UFI)=1)
 EVSIDR: Erased Valid SID frame rate (frames marked with (SID=0) or (SID=1) or ((BFI or UFI)=1) if a valid SID frame was transmitted)
 EVSIDUR: Erased Valid SID_UPDATE frame rate associated to an adaptive speech traffic channel
 ESIDR: Erased SID frame rate (frames marked with SID=0 if a valid SID frame was transmitted)
 EVRFR: Erased Valid RATSCCH frame rate associated to an adaptive speech traffic channel. This relates to the erasure of the RATSCCH message due to the failure to detect the RATSCCH identifier or due to a CRC failure.
 BER: Bit error rate
 RBER, BFI=0: Residual bit error rate (defined as the ratio of the number of errors detected over the frames defined as "good" to the number of transmitted bits in the "good" frames).
 RBER, (BFI or UFI)=0: Residual bit error rate (defined as the ratio of the number of errors detected over the frames defined as "reliable" to the number of transmitted bits in the "reliable" frames).
 RBER, SID=2 and (BFI or UFI)=0: Residual bit error rate of those bits in class I which do not belong to the SID codeword (defined as the ratio of the number of errors detected over the frames that are defined as "valid SID frames" to the number of transmitted bits in these frames, under the condition that a valid SID frame was sent).
 RBER, SID=1 or SID=2: Residual bit error rate of those bits in class I which do not belong to the SID codeword (defined as the ratio of the number of errors detected over the frames that are defined as "valid SID frames" or as "invalid SID frames" to the number of transmitted bits in these frames, under the condition that a valid SID frame was sent).
 TCH/AxS-INB FER: The frame error rate for the in-band channel. Valid for both Mode Indication and Mode Command/Mode Request. When testing all four code words shall be used an equal amount of time and the mode of both in-band channels (Mode Indication and Mode Command/Mode Request) shall be changed to a neighbouring mode not more often than every 22 speech frames (440 ms).

NOTE 3: $1 \leq \alpha \leq 1.6$. The value of α can be different for each channel condition but must remain the same for FER and class Ib RBER measurements for the same channel condition.

NOTE 4: FER for CCHs takes into account frames which are signalled as being erroneous (by the FIRE code, parity bits, or other means) or where the stealing flags are wrongly interpreted.

NOTE 5: Ideal FH case assumes perfect decorrelation between bursts. This case may only be tested if such a decorrelation is ensured in the test. For TU50 (ideal FH), sufficient decorrelation may be achieved with 4 frequencies spaced over 5 MHz.

NOTE 6: For AMR, the complete conformance should not be restricted to the channels identified with (*).

Table 1a: Input signal level (for normal BTS) at reference performance for GMSK modulated signals

GSM 900 and GSM 850						
Type of channel		Propagation conditions				
		static	TU50 (no FH)	TU50 (ideal FH)	RA250 (no FH)	HT100 (no FH)
PDTCH/CS-1	dBm	-104 ^(x)	-104	-104 ^(x)	-104 ^(x)	-103
PDTCH/CS-2	dBm	-104 ^(x)	-100	-101	-101	-99
PDTCH/CS-3	dBm	-104 ^(x)	-98	-99	-98	-96
PDTCH/CS-4	dBm	-101	-90	-90	*	*
USF/CS-1	dBm	-104 ^(x)	-101	-103	-103	-101
USF/CS-2 to 4	dBm	-104 ^(x)	-103	-104 ^(x)	-104 ^(x)	-104
PRACH/11 bits ¹⁾	dBm	-104 ^(x)	-104	-104	-103	-103
PRACH/8 bits ¹⁾	dBm	-104 ^(x)	-104	-104	-103	-103
GSM 900, GSM 850 and MXM 850						
Type of Channel		Propagation conditions				
		static	TU50 (no FH)	TU50 (ideal FH)	RA250 (no FH)	HT100 (no FH)
PDTCH/MCS-0 ⁶⁾	dBm	-104	-103	-103,5	-103	-102,5
PDTCH/MCS-1	dBm	-104 ^(x)	-102,5	-103	-103	-102
PDTCH/MCS-2	dBm	-104 ^(x)	-100,5	-101	-100,5	-100
PDTCH/MCS-3	dBm	-104 ^(x)	-96,5	-96,5	-92,5	-95,5
PDTCH/MCS-4	dBm	-101,5	-91	-91	*	*
USF/MCS-1 to 4	dBm	-104 ^(x)	-102,5	-104	-104 ^(x)	-102,5
PRACH/11 bits ^{2), 3)}	dBm	-104 ^(x)	-104	-104	-103	-103
PRACH/8 bits ¹⁾	dBm	-104 ^(x)	-104	-104	-103	-103
DCS 1 800 & PCS 1 900						
Type of channel		Propagation conditions				
		static	TU50 (no FH)	TU50 (ideal FH)	RA130 (no FH)	HT100 (no FH)
PDTCH/CS-1	dBm	-104 ^(x)	-104	-104	-104 ^(x)	-103
PDTCH/CS-2	dBm	-104 ^(x)	-100	-100	-101	-99
PDTCH/CS-3	dBm	-104 ^(x)	-98	-98	-98	-94
PDTCH/CS-4	dBm	-101	-88	-88	*	*
USF/CS-1	dBm	-104 ^(x)	-103	-103	-103	-101

DCS 1800, PCS 1900 and MXM 1900						
Type of channel		Propagation conditions				
		static	TU50 (no FH)	TU50 (ideal FH)	RA130 (no FH)	HT100 (no FH)
USF/CS-2 to 4	dBm	-104 ^(x)	-104 ^(x)	-104 ^(x)	-104 ^(x)	-103
PRACH/11 bits ¹⁾	dBm	-104 ^(x)	-104	-104	-103	-103
PRACH/8 bits ¹⁾	dBm	-104 ^(x)	-104	-104	-103	-103
DCS 1800, PCS 1900 and MXM 1900						
Type of channel		Propagation conditions				
		static	TU50 (no FH)	TU50 (ideal FH)	RA130 (no FH)	HT100 (no FH)
PDTCH/MCS-0 ⁶⁾	dBm	-104	-103	-103,5	-103	-102,5
PDTCH/MCS-1	dBm	-104 ^(x)	-102,5	-103	-103	-101,5
PDTCH/MCS-2	dBm	-104 ^(x)	-100,5	-101	-100,5	-99,5
PDTCH/MCS-3	dBm	-104 ^(x)	-96,5	-96,5	-92,5	-94,5
PDTCH/MCS-4	dBm	-101,5	-90,5	-90,5	*	*
USF/MCS-1 to 4	dBm	-104 ^(x)	-104	-104	-104 ^(x)	-102,5
PRACH/11 bits	dBm	-104 ^(x)	-104	-104	-103	-103
PRACH/8 bits	dBm	-104 ^(x)	-104	-104	-103	-103
NOTE 1: The specification for PDTCH/CS-1 applies also for PACCH, PBCCH, PAGCH, PPCH, PTCCH/D.						
NOTE 2: Ideal FH case assumes perfect decorrelation between bursts. This case may only be tested if such a decorrelation is ensured in the test. For TU50 (ideal FH), sufficient decorrelation may be achieved with 4 frequencies spaced over 5 MHz.						
NOTE 3: PDTCH/CS-4 and PDTCH/MCS-x can not meet the reference performance for some propagation conditions (*).						
NOTE 4: The complete conformance should not be restricted to the logical channels and channel models identified with (x)						
NOTE 5: Identification of the correct Training sequence is required. Cases identified by ¹⁾ include one training sequence and cases identified by ²⁾ include 3 training sequences according to 3GPP TS 45.002. The specification marked by ³⁾ also applies to CPRACH.						
NOTE 6: The specification of MCS-0 only applies in DL RTTI configuration.						

Table 1b: Input signal level (for normal BTS) at reference performance for 8-PSK modulated signals (convolutional coding)

GSM 900, GSM 850 and MXM 850						
Type of channel		Propagation conditions				
		static	TU50 (no FH)	TU50 (ideal FH)	RA250 (no FH)	HT100 (no FH)
PDTCH/MCS-5	dBm	-101	-96,5	-97	-96	-95
PDTCH/MCS-6	dBm	-99,5	-94	-94,5	-91	-91
PDTCH/MCS-7	dBm	-96	-89	-88,5	-87**	-86**
PDTCH/MCS-8	dBm	-93	-84	-84	*	-81,5**
PDTCH/MCS-9	dBm	-91,5	-80	-80	*	*
DCS 1 800, PCS 1900 and MXM 1900						
Type of channel		Propagation conditions				
		static	TU50 (no FH)	TU50 (ideal FH)	RA130 (no FH)	HT100 (no FH)
PDTCH/MCS-5	dBm	-101	-95,5	-97	-96	-93
PDTCH/MCS-6	dBm	-99,5	-94	-94	-91	-85,5
PDTCH/MCS-7	dBm	-96	-87	-86,5	-87**	*
PDTCH/MCS-8	dBm	-93	-86,5**	-86,5**	*	*
PDTCH/MCS-9	dBm	-91,5	-83**	-83**	*	*
Performance is specified at 30% BLER for those cases identified with mark **.						
NOTE 1: Ideal FH case assumes perfect decorrelation between bursts. This case may only be tested if such a decorrelation is ensured in the test. For TU50 (ideal FH), sufficient decorrelation may be achieved with 4 frequencies spaced over 5 MHz.						
NOTE 2: PDTCH for MCS-x can not meet the reference performance for some propagation conditions (*).						

Table 1c: Input signal level (for MS) at reference performance for 8-PSK modulated signals (convolutional coding)

GSM 900 and GSM 850						
Type of channel		Propagation conditions				
		static	TU50 (no FH)	TU50 (ideal FH)	RA250 (no FH)	HT100 (no FH)
PDTCH/MCS-5	dBm	-98	-93	-94	-93	-92
PDTCH/MCS-6	dBm	-96	-91	-91,5	-88	-89
PDTCH/MCS-7	dBm	-93	-84	-84	*	-83**
PDTCH/MCS-8	dBm	-90,5	-83**	-83**	*	*
PDTCH/MCS-9	dBm	-86	-78,5**	-78,5**	*	*
USF/MCS-5 to 9	dBm	-102 ^(x)	-97,5	-99	-100	-99
DCS 1 800 and PCS 1900						
Type of channel		Propagation conditions				
		static	TU50 (no FH)	TU50 (ideal FH)	RA130 (no FH)	HT100 (no FH)
PDTCH/MCS-5	dBm	-98	-93,5	-93,5	-93	-89,5
PDTCH/MCS-6	dBm	-96	-91	-91	-88	-83,5
PDTCH/MCS-7	dBm	-93	-81,5	-80,5	*	*
PDTCH/MCS-8	dBm	-90,5	-80**	-80**	*	*
PDTCH/MCS-9	dBm	-86	*	*	*	*
USF/MCS-5 to 9	dBm	-102 ^(x)	-99	-99	-100	-99

Performance is specified at 30% BLER for those cases identified with mark **.

NOTE 1: Ideal FH case assumes perfect decorrelation between bursts. This case may only be tested if such a decorrelation is ensured in the test. For TU50 (ideal FH), sufficient decorrelation may be achieved with 4 frequencies spaced over 5 MHz.

NOTE 2: PDTCH for MCS-x can not meet the reference performance for some propagation conditions (*).

NOTE 3: The complete conformance should not be restricted to the logical channels and channel models identified with (x).

Table 1d: Input signal level (for normal BTS) at reference performance for ECSD (GMSK and 8-PSK modulated signals)

GSM 900 and GSM 850						
Type of Channel		Propagation conditions				
		Static	TU50 (no FH)	TU50 (ideal FH)	RA250 (no FH)	HT100 (no FH)
E-FACCH/F	dBm	-104 ^(x)	-101	-102	-102	-98
E-TCH/F28.8 T	dBm	-99,5	-93,5	-95	-93,5	-94,5
E-TCH/F 32 T	dBm	-104	-97,5	-100	-100	-96,5
E-TCH/F28.8 NT	dBm	-100	-95,5	-96,5	-96,5	-96
E-TCH/F43.2 NT	dBm	-97	-91	-92	-89	-89,5
DCS 1 800 & PCS 1900						
Type of Channel		Propagation conditions				
		Static	TU50 (no FH)	TU50 (ideal FH)	RA130 (no FH)	HT100 (no FH)
E-FACCH/F	dBm	-104 ^(x)	-102	-102	-102	-98
E-TCH/F28.8 T	dBm	-99,5	-94,5	-95	-92,5	-93
E-TCH/F 32 T	dBm	-104	-98,5	-100	-100	-97
E-TCH/F28.8 NT	dBm	-100	-96	-96,5	-96	-95
E-TCH/F43.2 NT	dBm	-97	-91,5	-91,5	-88,5	-86

NOTE 1: Ideal FH case assumes perfect decorrelation between bursts. This case may only be tested if such a decorrelation is ensured in the test. For TU50 (ideal FH), sufficient decorrelation may be achieved with 4 frequencies spaced over 5 MHz.

NOTE 2: The complete conformance should not be restricted to the logical channels and channel models identified with (x).

Table 1e: Input signal level (for MS) at reference performance for ECSD (GMSK and 8-PSK modulated signals)

GSM 850 and GSM 900						
Type of Channel		Propagation conditions				
		Static	TU50 (no FH)	TU50 (ideal FH)	RA250 (no FH)	HT100 (no FH)
E-FACCH/F	dBm	-102 ^(x)	-99	-100	-100	-96
E-TCH/F28.8 T	dBm	-97.5	-91.5	-93	-91.5	-90
E-TCH/F 32 T	dBm	-98.5	-93	-94	-94	-91.5
E-TCH/F28.8 NT	dBm	-98	-93.5	-94.5	-94.5	-92.5
E-TCH/F43.2 NT	dBm	-95	-89	-90	-87	-84.5
DCS 1 800 & PCS 1900						
Type of Channel		Propagation conditions				
		Static	TU50 (no FH)	TU50 (ideal FH)	RA130 (no FH)	HT100 (no FH)
E-FACCH/F	dBm	-102 ^(x)	-100	-100	-100	-96
E-TCH/F28.8 T	dBm	-97.5	-92.5	-93	-90	-87.5
E-TCH/F 32 T	dBm	-98.5	-94	-94	-94	-87.5
E-TCH/F28.8 NT	dBm	-98	-94	-94.5	-93.5	-90.5
E-TCH/F43.2 NT	dBm	-95	-89.5	-89.5	-86.5	*

NOTE 1: Ideal FH case assumes perfect decorrelation between bursts. This case may only be tested if such a decorrelation is ensured in the test. For TU50 (ideal FH), sufficient decorrelation may be achieved with 4 frequencies spaced over 5 MHz.

NOTE 2: E-TCH/F for 43.2 NT can not meet the reference performance for some propagation conditions (*).

NOTE 3: The complete conformance should not be restricted to the logical channels and channel models identified with (x).

Table 1f: Reference sensitivity performance for GMSK modulated signals

GSM 850 and GSM 900					
Type of Channel		Propagation conditions			
		Static	TU50 (no FH)	RA250 (no FH)	HT100 (no FH)
TCH/WFS12.65	(dBm)	-104	-99,5	-101	-99
	Class 1b (RBER)	0,50	0,35	0,72	0,62
TCH/ WFS8.85	(dBm)	-104	-102	-104	-102
	Class 1b (RBER)	0,50	0,38	0,72	0,62
TCH/ WFS6.60	(dBm)	-104	-103	-104	-103,5
	Class 1b (RBER)	0,24	0,15	0,19	0,24

DCS 1 800 & PCS 1 900			
Type of Channel		Propagation conditions	
		TU50 (no FH)	HT100 (no FH)
TCH/WFS12.65	(dBm)	-100,5	-99
	Class 1b (RBER)	0,62	0,66
TCH/ WFS8.85	(dBm)	-103,5	-102
	Class 1b (RBER)	0,59	0,58
TCH/ WFS6.60	(dBm)	-104	-103,5
	Class 1b (RBER)	0,17	0,25

NOTE 1:	<p>Definitions:</p> <p>FER: Frame erasure rate (frames marked with BFI=1)</p> <p>UFR: Unreliable frame rate (frames marked with (BFI or UFI)=1)</p> <p>EVSIDR: Erased Valid SID frame rate (frames marked with (SID=0) or (SID=1) or ((BFI or UFI)=1) if a valid SID frame was transmitted)</p> <p>EVSIDUR: Erased Valid SID_UPDATE frame rate associated to an adaptive speech traffic channel</p> <p>ESIDR: Erased SID frame rate (frames marked with SID=0 if a valid SID frame was transmitted)</p> <p>EVRFR: Erased Valid RATSCCH frame rate associated to an adaptive speech traffic channel This relates to the erasure of the RATSCCH message due to the failure to detect the RATSCCH identifier or due to a CRC failure.</p> <p>BER: Bit error rate</p> <p>RBER, BFI=0: Residual bit error rate (defined as the ratio of the number of errors detected over the frames defined as "good" to the number of transmitted bits in the "good" frames).</p> <p>RBER, (BFI or UFI)=0: Residual bit error rate (defined as the ratio of the number of errors detected over the frames defined as "reliable" to the number of transmitted bits in the "reliable" frames).</p> <p>RBER, SID=2 and (BFI or UFI)=0: Residual bit error rate of those bits in class I which do not belong to the SID codeword (defined as the ratio of the number of errors detected over the frames that are defined as "valid SID frames" to the number of transmitted bits in these frames, under the condition that a valid SID frame was sent).</p> <p>RBER, SID=1 or SID=2: Residual bit error rate of those bits in class I which do not belong to the SID codeword (defined as the ratio of the number of errors detected over the frames that are defined as "valid SID frames" or as "invalid SID frames" to the number of transmitted bits in these frames, under the condition that a valid SID frame was sent).</p> <p>TCH/WxS-INB FER: The frame error rate for the in-band channel. Valid for both Mode Indication and Mode Command/Mode Request. When testing all four code words shall be used an equal amount of time and the mode of both in-band channels (Mode Indication and Mode Command/Mode Request) shall be changed to a neighbouring mode not more often than every 22 speech frames (440 ms).</p>
NOTE 2:	<p>The requirements for the DCS 1800 & PCS 1900 Static propagation condition are the same as for the GSM 850 & GSM 900 Static propagation condition, the requirements for the GSM 850 & GSM 900 TU50 (ideal FH) and DCS 1800 & PCS 1900 TU50 (ideal FH) propagation conditions are the same as for the DCS 1800 & PCS 1900 TU50 (no FH) propagation condition, and the requirements for the DCS 1800 & PCS 1900 RA130 (no FH) propagation condition are the same as for the GSM 850 & GSM 900 RA250 (no FH) propagation condition.</p>
NOTE 3:	<p>Ideal FH performance is already tested for the TCH/FS channel, therefore, these requirements are given for information purposes and need not be tested.</p>
NOTE 4:	<p>As a minimum the test of performance shall include all propagation conditions for maximum implemented codec rate and the remaining implemented codec rates for one propagation condition only, e.g. TU50 (no FH).</p>
NOTE 5:	<p>The performance requirements for inband signalling, SID_UPDATE and RATSCCH are the same as those given for TCH/AFS in Table 1. It is sufficient to test inband signalling, SID_UPDATE and RATSCCH requirements for only one of the channel types TCH/AFS and TCH/WFS.</p>

Table 1g: Reference sensitivity performance for 8-PSK modulated signals

GSM 850 and GSM 900						
Type of channel	Propagation conditions					
	static	TU50 (no FH)	TU50 (ideal FH)	RA250 (no FH)	HT100 (no FH)	
O-FACCH/F (dBm)	-104	-100,5	-101,5	-101,5	-100	
O-FACCH/H (dBm)	-104	-100,5	-100,5	-101	-99	
O-TCH/AHS12.2 (dBm)	-100,5	-94,5	-95	-94	-92,5	
Class 1b (RBER)	0,71	0,30	0,35	0,29	0,40	
O-TCH/AHS10.2 (dBm)	-101	-95,5	-96	-95	-93,5	
Class 1b (RBER)	0,35	0,15	0,15	0,13	0,19	
O-TCH/AHS7.95 (dBm)	-102,5	-96,5	-97	-96,5	-94,5	
Class 1b (RBER)	0,10	0,08	0,08	0,05	0,10	
O-TCH/AHS7.4 (dBm)	-102,5	-97,5	-97,5	-97	-95	
Class 1b (RBER)	0,16	0,15	0,15	0,12	0,17	
O-TCH/AHS6.7 (dBm)	-103	-98	-98,5	-97,5	-95,5	
Class 1b (RBER)	0,22	0,14	0,15	0,12	0,16	
O-TCH/AHS5.9 (dBm)	-103,5	-98	-98,5	-98,5	-96,5	
Class 1b (RBER)	0,57	0,20	0,19	0,15	0,25	
O-TCH/AHS5.15 (dBm)	-104	-98,5	-99	-98,5	-97	
Class 1b (RBER)	0,15	0,10	0,08	0,07	0,11	
O-TCH/AHS4.75 (dBm)	-104	-99,5	-99,5	-99,5	-97,5	
Class 1b (RBER)	0,18	0,15	0,11	0,11	0,10	
O-TCH/AHS-INB (FER)	-103,5	-99	-99,5	-98,5	-98	
O-TCH/AHS (EVSIDUR)	-104	-100,5	-101,5	-101,5	-99	
O-TCH/AHS (EVRFR)	-104	-101	-101,5	-101,5	-99	
O-TCH/WFS23.85 (dBm)	-100,5	-95	-96,5	-97	-94,5	
Class 1b (RBER)	1,00	0,16	0,28	0,24	0,28	
O-TCH/WFS15.85 (dBm)	-102,5	-97,5	-99	-100,5	-97	
Class 1b (RBER)	0,50	0,44	0,33	0,64	0,50	
O-TCH/WFS12.65 (dBm)	-104	-99	-100	-101	-98,5	
Class 1b (RBER)	0,89	0,37	0,21	0,51	0,59	
O-TCH/WFS8.85 (dBm)	-104	-100,5	-102	-102,5	-100,5	
Class 1b (RBER)	0,77	0,31	0,22	0,42	0,48	
O-TCH/WFS6.60 (dBm)	-104	-101,5	-103	-103,5	-101,5	
Class 1b (RBER)	0,05	0,18	0,12	0,23	0,27	
O-TCH/WFS-INB (dBm)	-104	-103,5	-103,5	-104	-103	
O-TCH/WFS (EVSIDUR)	-104	-100	-102	-101	-99,5	
O-TCH/WFS (EVRFR)	-104	-101	-103	-103	-101	
O-TCH/WHS12.65 (dBm)	-100,5	-94,5	-95	-93,5	-92,5	
Class 1b (RBER)	0,57	0,30	0,38	0,30	0,40	
O-TCH/ WHS8.85 (dBm)	-102,5	-96	-96,5	-96	-94	
Class 1b (RBER)	0,19	0,10	0,11	0,10	0,13	
O-TCH/ WHS6.60 (dBm)	-103	-98	-98,5	-97,5	-96	
Class 1b (RBER)	0,23	0,15	0,15	0,13	0,19	

DCS 1 800 & PCS 1 900			
Type of channel		Propagation conditions	
		TU50 (no FH)	HT100 (no FH)
O-FACCH/F	(dBm)	-100,5	-100
O-FACCH/H	(dBm)	-100	-99
O-TCH/AHS12.2	(dBm)	-94,5	-92
	Class 1b (RBER)	0,30	0,42
O-TCH/AHS10.2	(dBm)	-95,5	-93
	Class 1b (RBER)	0,17	0,20
O-TCH/AHS7.95	(dBm)	-96,5	-94
	Class 1b (RBER)	0,08	0,08
O-TCH/AHS7.4	(dBm)	-97	-94,5
	Class 1b (RBER)	0,15	0,17
O-TCH/AHS6.7	(dBm)	-98	-95,5
	Class 1b (RBER)	0,16	0,19
O-TCH/AHS5.9	(dBm)	-98,5	-96
	Class 1b (RBER)	0,22	0,24
O-TCH/AHS5.15	(dBm)	-99	-97
	Class 1b (RBER)	0,11	0,12
O-TCH/AHS4.75	(dBm)	-99,5	-97,5
	Class 1b (RBER)	0,15	0,17
O-TCH/AHS-INB	(FER)	-99	-97,5
O-TCH/AHS	(EVSIDUR)	-97,5	-99
O-TCH/AHS	(EVRFR)	-101	-99
O-TCH/WFS23.85	(dBm)	-96	-94
	Class 1b (RBER)	0,17	0,26
O-TCH/WFS15.85	(dBm)	-98,5	-97
	Class 1b (RBER)	0,50	0,60
O-TCH/WFS12.65	(dBm)	-100	-98,5
	Class 1b (RBER)	0,45	0,63
O-TCH/WFS8.85	(dBm)	-102	-100,5
	Class 1b (RBER)	0,38	0,57
O-TCH/WFS6.60	(dBm)	-102,5	-101,5
	Class 1b (RBER)	0,20	0,30
O-TCH/WFS-INB	(dBm)	-103	-102,5
O-TCH/WFS	(EVSIDUR)	-101	-99
O-TCH/WFS	(EVRFR)	-102,5	-101
O-TCH/WHS12.65	(dBm)	-94,5	-92
	Class 1b (RBER)	0,34	0,44
O-TCH/ WHS8.85	(dBm)	-96	-94
	Class 1b (RBER)	0,12	0,15
O-TCH/ WHS6.60	(dBm)	-98	-95,5
	Class 1b (RBER)	0,16	0,19

- NOTE 1: Definitions:
FER: Frame erasure rate (frames marked with BFI=1)
EVSIDUR: Erased Valid SID_UPDATE frame rate associated to an adaptive speech traffic channel
EVRFR: Erased Valid RATSCCH frame rate associated to an adaptive speech traffic channel. This relates to the erasure of the RATSCCH message due to the failure to detect the RATSCCH identifier or due to a CRC failure.
BER: Bit error rate.
RBER: Residual bit error rate.
O-TCH/AxS-INB and O-TCH/WxS-INB FER: The frame error rate for the in-band channel. Valid for both Mode Indication and Mode Command/Mode Request. When testing all four code words shall be used an equal amount of time and the mode of both in-band channels (Mode Indication and Mode Command/Mode Request) shall be changed to a neighbouring mode not more often than every 22 speech frames (440 ms).
- NOTE 2: FER for CCHs takes into account frames which are signalled as being erroneous (by the FIRE code, parity bits, or other means) or where the stealing flags are wrongly interpreted.
- NOTE 3: Ideal FH case assumes perfect decorrelation between bursts. This case may only be tested if such a decorrelation is ensured in the test. For TU50 (ideal FH), sufficient decorrelation may be achieved with 4 frequencies spaced over 5 MHz.
- NOTE 4: The requirements for DCS 1800 & PCS 1900 on TU50 (ideal FH) propagation conditions are the same as for TU50 (no FH).
The requirements for the DCS 1800 & PCS 1900 Static propagation condition are the same as for the GSM 850 & GSM 900 Static propagation condition, and the requirements for the DCS 1800 & PCS 1900 RA130 (no FH) propagation condition are the same as for the GSM 850 & GSM 900 RA250 (no FH) propagation condition.
- NOTE 5: As a minimum the test of performance shall include all propagation conditions for maximum implemented codec rate and the remaining implemented codec rates for one propagation condition only, e.g. TU50 (no FH).
- NOTE 6: For O-TCH/WHS, the performance requirements for inband signalling, SID_UPDATE and RATSCCH are the same as those of O-TCH/AHS. It is sufficient to test inband signalling, SID_UPDATE and RATSCCH requirements for only one of the channel types O-TCH/AHS and O-TCH/WHS.

Table 1h: Input signal level at reference performance for FLO

GSM 900 and GSM 850						
FLO Configuration		Propagation conditions				
		Static	TU50 (no FH)	TU50 (ideal FH)	RA250 (no FH)	HT100 (no FH)
Reference TFC 1	(dBm)	-104,0	-102,0	⁽²⁾	-103,0	-101,5
Reference TFC 2	(dBm)	-104,0	-100,5	⁽²⁾	-100,5	-99,5
Reference TFC 3	(dBm)	-104,0	-100,5	⁽²⁾	-102,0	-101,0
Reference TFC 4	(dBm)	-102,0	-96,0	-96,0	-97,0	-94,0
Reference TFC 5	(dBm)	-101,5	-96,0	-97,5	-98,0	-95,5
Reference TFC 6	(dBm)	-100,0	-94,0	-94,0	-91,5	-91,5
Reference TFC 7	(dBm)	-96,0	-88,5	-88,5	-	-
DCS 1 800 & PCS 1900						
FLO Configuration		Propagation conditions				
		Static	TU50 (no FH)	TU50 (ideal FH)	RA130 (no FH)	HT100 (no FH)
Reference TFC 1	(dBm)	⁽³⁾	-101,5	⁽³⁾	⁽³⁾	-101,5
Reference TFC 2	(dBm)	⁽³⁾	-100,0	⁽³⁾	⁽³⁾	-99,5
Reference TFC 3	(dBm)	⁽³⁾	-101,5	⁽³⁾	⁽³⁾	-101,0
Reference TFC 4	(dBm)	⁽³⁾	-95,5	⁽³⁾	⁽³⁾	-93,0
Reference TFC 5	(dBm)	⁽³⁾	-97,0	⁽³⁾	⁽³⁾	-95,0
Reference TFC 6	(dBm)	⁽³⁾	-94,0	⁽³⁾	⁽³⁾	-88,5
Reference TFC 7	(dBm)	⁽³⁾	-88,0	⁽³⁾	⁽³⁾	-
NOTE 1: Ideal FH case assumes perfect decorrelation between bursts. This case may only be tested if such a decorrelation is ensured in the test. For TU50 (ideal FH), sufficient decorrelation may be achieved with 4 frequencies spaced over 5 MHz.						
NOTE 2: The requirements for GSM 900 & GSM 850 on TU50 (ideal FH) propagation conditions are the same as for TU50 (no FH) for Reference TFCs 1, 2 and 3.						
NOTE 3: The requirements for the DCS 1800 & PCS 1900 Static propagation condition are the same as for the GSM 850 & GSM 900 Static propagation condition, the requirements for the DCS 1800 & PCS 1900 TU50 (ideal FH) propagation conditions are the same as for the DCS 1800 & PCS 1900 TU50 (no FH) propagation condition, and the requirements for the DCS 1800 & PCS 1900 RA130 (no FH) propagation condition are the same as for the GSM 850 & GSM 900 RA250 (no FH) propagation condition.						

Table 1i: Input signal level at reference performance for Repeated Downlink FACCH and Repeated SACCH

GSM 900 and GSM 850						
		Propagation conditions				
		Static	TU50 (no FH)	TU50 (ideal FH)	RA250 (no FH)	HT100 (no FH)
FACCH/F	(dBm)	-104	-104	⁽²⁾	-104	-104
FACCH/H		[tbd]	[tbd]	⁽²⁾	[tbd]	[tbd]
SACCH		-104	-104	⁽²⁾	-104	-104
DCS 1 800 & PCS 1900						
		Propagation conditions				
		Static	TU50 (no FH)	TU50 (ideal FH)	RA130 (no FH)	HT100 (no FH)
FACCH/F	(dBm)	⁽³⁾	-104	⁽³⁾	⁽³⁾	-104
FACCH/H		⁽³⁾	[tbd]	⁽³⁾	⁽³⁾	[tbd]
SACCH		⁽³⁾	-104	⁽³⁾	⁽³⁾	-104
<p>NOTE 1: Ideal FH case assumes perfect decorrelation between bursts. This case may only be tested if such a decorrelation is ensured in the test. For TU50 (ideal FH), sufficient decorrelation may be achieved with 4 frequencies spaced over 5 MHz.</p> <p>NOTE 2: The requirements for GSM 900 & GSM 850 on TU50 (ideal FH) propagation conditions are the same as for TU50 (no FH).</p> <p>NOTE 3: The requirements for the DCS 1800 & PCS 1900 Static propagation condition are the same as for the GSM 850 & GSM 900 Static propagation condition, the requirements for the DCS 1800 & PCS 1900 TU50 (ideal FH) propagation conditions are the same as for the DCS 1800 & PCS 1900 TU50 (no FH) propagation condition, and the requirements for the DCS 1800 & PCS 1900 RA130 (no FH) propagation condition are the same as for the GSM 850 & GSM 900 RA250 (no FH) propagation condition.</p>						

Table 1j: Input signal level at reference performance for Downlink Advanced Receiver Performance – phase II

		GSM 900 and GSM 850 Propagation conditions			
		TU50 (noFH)		HT100 (noFH)	
		Corr. = 0; AGI = 0	Corr.=0,7; AGI=-6dB	Corr. = 0; AGI = 0	Corr.=0,7; AGI=-6dB
TCH/FS	FER (dbm)	-105,0	-102,5	-105,0	-102,5
	Rber1b	0,07%	0,08%	0,08%	0,08%
	Rber2	4,79%	4,79%	6,10%	6,09%
TCH/AFS12.2	FER (dBm)	-105,0	-102,0	-105,0	-102,0
	Rber1b	0,66%	0,64%	0,98%	0,95%
TCH/AFS7.4	FER (dBm)	-105,0	-104,5	-105,0	-105,0
	Rber1b	0,18%	0,18%	0,22%	0,18%
TCH/AFS5.9	FER (dBm)	-105,0	-105,0	-105,0	-105,0
	Rber1b	0,15%	0,17%	0,19%	0,20%
TCH/AHS7.4	FER (dBm)	-104,0	-100,5	-103,0	-98,5
	Rber1b	0,56%	0,54%	0,57%	0,56%
	Rber2	2,50%	2,43%	2,44%	2,31%
TCH/AHS5.9	FER (dBm)	-105,0	-102,0	-104,0	-99,0
	Rber1b	0,39%	0,69%	0,72%	0,75%
	Rber2	4,22%	3,94%	3,99%	3,88%
PDTCH CS-1	BLER (dBm)	-105,0	-103,5	-105,0	-102,5
PDTCH CS-2	BLER (dBm)	-105,0	-101,5	-104,0	-100,0
PDTCH CS-3	BLER (dBm)	-103,5	-100,0	-102,0	-97,5
PDTCH CS-4	BLER (dBm)	-97,0	-93,0	-92,0	-88,0
PDTCH MCS-1	BLER (dBm)	-105,0	-103,0	-105,0	-101,0
PDTCH MCS-2	BLER (dBm)	-105,0	-102,0	-104,5	-100,0
PDTCH MCS-3	BLER (dBm)	-102,5	-99,0	-101,0	-95,5
PDTCH MCS-4	BLER (dBm)	-98,5	-95,0	-93,0	-89,0
PDTCH MCS-5	BLER (dBm)	-100,0	-97,0	-98,5	-94,0
PDTCH MCS-6	BLER (dBm)	-98,0	-94,5	-96,5	-91,5
PDTCH MCS-7	BLER (dBm)	-94,0	-90,5	-90,0	-86,0
PDTCH MCS-8	BLER (dBm) (30%)	-92,0**	-88,5**	-87,0**	-82,5**
PDTCH MCS-9	BLER (dBm) (30%)	-89,0**	-85,5**	-81,0**	-
PDTCH DAS-5	BLER (dBm)	[td]	[td]	[td]	[td]
PDTCH DAS-6	BLER (dBm)	[td]	[td]	[td]	[td]
PDTCH DAS-7	BLER (dBm)	[td]	[td]	[td]	[td]
PDTCH DAS-8	BLER (dBm)	[td]	[td]	[td]	[td]
PDTCH DAS-9	BLER (dBm)	[td]	[td]	[td]	[td]
PDTCH DAS-10	BLER (dBm)	[td]	[td]	[td]	[td]
PDTCH DAS-11	BLER (dBm)	[td]	[td]	[td]	[td]
PDTCH DAS-12	BLER (dBm)	[td]	[td]	[td]	[td]
PDTCH DBS-5	BLER (dBm)	[td]	[td]	[td]	[td]
PDTCH DBS-6	BLER (dBm)	[td]	[td]	[td]	[td]
PDTCH DBS-7	BLER (dBm)	[td]	[td]	[td]	[td]
PDTCH DBS-8	BLER (dBm)	[td]	[td]	[td]	[td]
PDTCH DBS-9	BLER (dBm)	[td]	[td]	[td]	[td]
PDTCH DBS-10	BLER (dBm)	[td]	[td]	[td]	[td]
PDTCH DBS-11	BLER (dBm)	[td]	[td]	[td]	[td]
PDTCH DBS-12	BLER (dBm)	[td]	[td]	[td]	[td]

NOTE: Performance is specified at 30% BLER for those cases identified with mark "**"

NOTE: Performance is not specified for those cases identified with mark "-"

Table 1j (Continued) :Input signal level at reference performance for Downlink Advanced Receiver Performance – phase II

		DCS 1800 & PCS 1900			
		Propagation conditions			
		TU50 (noFH)		HT100 (noFH)	
		Corr. = 0; AGI = 0	Corr.=0,7; AGI=-6dB	Corr. = 0; AGI = 0	Corr.=0,7; AGI=-6dB
TCH/FS	FER (dbm)	-105,0	-103,0	-105,0	-102,5
	Rber1b	0,08%	0,08%	0,08%	0,09%
	Rber2	6,01%	5,99%	5,95%	6,06%
TCH/AFS12.2	FER (dBm)	-105,0	-103,0	-105,0	-102,0
	Rber1b	0,92%	0,95%	0,93%	1,07%
TCH/AFS7.4	FER (dBm)	-105,0	-105,0	-105,0	-104,5
	Rber1b	0,18%	0,19%	0,25%	0,17%
TCH/AFS5.9	FER (dBm)	-105,0	-105,0	-105,0	-105,0
	Rber1b	0,21%	0,20%	0,20%	0,22%
TCH/AHS7.4	FER (dBm)	-104,0	-100,0	-102,5	-98,2
	Rber1b	0,57%	0,54%	0,64%	0,66%
	Rber2	2,50%	2,40%	2,46%	2,43%
TCH/AHS5.9	FER (dBm)	-105,0	-102,0	-104,5	-100,5
	Rber1b	0,41%	0,70%	0,77%	0,76%
	Rber2	4,22%	4,01%	3,93%	3,91%
PDTCH CS-1	BLER (dBm)	-105,0	-104,0	-105,0	-103,0
PDTCH CS-2	BLER (dBm)	-105,0	-101,5	-104,0	-100,0
PDTCH CS-3	BLER (dBm)	-103,5	-100,0	-102,0	-97,5
PDTCH CS-4	BLER (dBm)	-96,5	-92,5	-92,5	-85,5
PDTCH MCS-1	BLER (dBm)	-105,0	-103,5	-105,0	-101,0
PDTCH MCS-2	BLER (dBm)	-105,0	-102,0	-104,0	-100,0
PDTCH MCS-3	BLER (dBm)	-102,5	-99,0	-101,0	-96,0
PDTCH MCS-4	BLER (dBm)	-98,5	-94,5	-93,5	-87,0
PDTCH MCS-5	BLER (dBm)	-100,5	-97,5	-98,0	-93,5
PDTCH MCS-6	BLER (dBm)	-98,5	-95,0	-96,5	-90,5
PDTCH MCS-7	BLER (dBm)	-94,0	-90,5	-84,0	-79,0
PDTCH MCS-8	BLER (dBm) (30%)	-91,5**	-88,0**	-83,0**	-78,0**
PDTCH MCS-9	BLER (dBm) (30%)	-88,0**	-83,0**	-	-
PDTCH DAS-5	BLER (dBm)	[tbd]	[tbd]	[tbd]	[tbd]
PDTCH DAS-6	BLER (dBm)	[tbd]	[tbd]	[tbd]	[tbd]
PDTCH DAS-7	BLER (dBm)	[tbd]	[tbd]	[tbd]	[tbd]
PDTCH DAS-8	BLER (dBm)	[tbd]	[tbd]	[tbd]	[tbd]
PDTCH DAS-9	BLER (dBm)	[tbd]	[tbd]	[tbd]	[tbd]
PDTCH DAS-10	BLER (dBm)	[tbd]	[tbd]	[tbd]	[tbd]
PDTCH DAS-11	BLER (dBm)	[tbd]	[tbd]	[tbd]	[tbd]
PDTCH DAS-12	BLER (dBm)	[tbd]	[tbd]	[tbd]	[tbd]
PDTCH DBS-5	BLER (dBm)	[tbd]	[tbd]	[tbd]	[tbd]
PDTCH DBS-6	BLER (dBm)	[tbd]	[tbd]	[tbd]	[tbd]
PDTCH DBS-7	BLER (dBm)	[tbd]	[tbd]	[tbd]	[tbd]
PDTCH DBS-8	BLER (dBm)	[tbd]	[tbd]	[tbd]	[tbd]
PDTCH DBS-9	BLER (dBm)	[tbd]	[tbd]	[tbd]	[tbd]
PDTCH DBS-10	BLER (dBm)	[tbd]	[tbd]	[tbd]	[tbd]
PDTCH DBS-11	BLER (dBm)	[tbd]	[tbd]	[tbd]	[tbd]
PDTCH DBS-12	BLER (dBm)	[tbd]	[tbd]	[tbd]	[tbd]

NOTE: Performance is specified at 30% BLER for those cases identified with mark "**"

NOTE: Performance is not specified for those cases identified with mark "-"

Table 1k: Input signal level (for normal BTS) at reference performance for 16-QAM modulated signals (Normal symbol rate and BTTI) (EGPRS2-A UL)

GSM 900 and GSM 850						
Type of channel		Propagation conditions				
		static	TU50 (no FH)	TU50 (ideal FH)	RA250 (no FH)	HT100 (no FH)
PDTCH/UAS-7	dBm	-97,5	-92	-93	-93,5	-91
PDTCH/UAS-8	dBm	-96,5	-91	-91,5	-90,5	-89
PDTCH/UAS-9	dBm	-96	-89	-89,5	-85,5	-86,5
PDTCH/UAS-10	dBm	-95	-87	-87	-84,5**	-86,5**
PDTCH/UAS-11	dBm	-93	-82,5	-82	*	-80,5**
DCS 1 800 and PCS 1900						
Type of channel		Propagation conditions				
		static	TU50 (no FH)	TU50 (ideal FH)	RA130 (no FH)	HT100 (no FH)
PDTCH/UAS-7	dBm	(3)	-92,5	(3)	(3)	-85
PDTCH/UAS-8	dBm	(3)	-91	(3)	(3)	-87,5**
PDTCH/UAS-9	dBm	(3)	-89	(3)	(3)	-81,5**
PDTCH/UAS-10	dBm	(3)	-85	(3)	(3)	*
PDTCH/UAS-11	dBm	(3)	-86**	(3)	(3)	*

Performance is specified at 30% BLER for those cases identified with mark **.

NOTE 1: Ideal FH case assumes perfect decorrelation between bursts. This case may only be tested if such a decorrelation is ensured in the test. For TU50 (ideal FH), sufficient decorrelation may be achieved with 4 frequencies spaced over 5 MHz.

NOTE 2: PDTCH for UAS-x can not meet the reference performance for some propagation conditions (*).

NOTE 3: The requirements for the DCS 1800 & PCS 1900 Static propagation condition are the same as for the GSM 850 & GSM 900 Static propagation condition, the requirements for DCS 1800 & PCS 1900 TU50 (ideal FH) propagation conditions are the same as for the DCS 1800 & PCS 1900 TU50 (no FH) propagation condition, and the requirements for the DCS 1800 & PCS 1900 RA130 (no FH) propagation condition are the same as for the GSM 850 & GSM 900 RA250 (no FH) propagation condition.

Table 1l: Input signal level (for MS) at reference performance for 8-PSK, 16-QAM and 32-QAM modulated signals (Normal symbol rate, BTTI and turbo-coding) (EGPRS2-A DL)

GSM 900 and GSM 850						
Type of channel		Propagation conditions				
		static	TU50 (no FH)	TU50 (ideal FH)	RA250 (no FH)	HT100 (no FH)
PDTCH/DAS-5	dBm	-100	-94	-94,5	-95,5	-92
PDTCH/DAS-6	dBm	-98,5	-93	-94	-94	-90,5
PDTCH/DAS-7	dBm	-97,5	-92	-92,5	-91,5	-88
PDTCH/DAS-8	dBm	-95	-89,5	-90	-88,5	-82,5
PDTCH/DAS-9	dBm	-94	-87	-87,5	-82,5	-84,5**
PDTCH/DAS-10	dBm	-90	-83,5	-84	-82**	*
PDTCH/DAS-11	dBm	-88	-78,5	-79	*	*
PDTCH/DAS-12	dBm	-84	-76**	-76**	*	*
USF/DAS-5 to 7	dBm	(4)	(4)	(4)	(4)	(4)
USF/DAS-8 to 9	dBm	-104,0	-98,5	-101,0	-102,5	-100,0
USF/DAS-10 to 12	dBm	-104,0	-98,0	-99,0	-101,5	-99,0

(To be continued)

Table 11: Input signal level (for MS) at reference performance for 8-PSK, 16-QAM and 32-QAM modulated signals (Normal symbol rate, BTTI and turbo-coding) (EGPRS2-A DL) (continued)

		DCS 1800 and PCS 1900				
Type of channel		Propagation conditions				
		static	TU50 (no FH)	TU50 (ideal FH)	RA130 (no FH)	HT100 (no FH)
PDTCH/DAS-5	dBm	(3)	-94	(3)	(3)	-92
PDTCH/DAS-6	dBm	(3)	-93,5	(3)	(3)	-90
PDTCH/DAS-7	dBm	(3)	-92	(3)	(3)	-84
PDTCH/DAS-8	dBm	(3)	-89	(3)	(3)	-88**
PDTCH/DAS-9	dBm	(3)	-86	(3)	(3)	-80,5**
PDTCH/DAS-10	dBm	(3)	-82,5	(3)	(3)	*
PDTCH/DAS-11	dBm	(3)	-78,5**	(3)	(3)	*
PDTCH/DAS-12	dBm	(3)	*	(3)	(3)	*
USF/DAS-5 to 7	dBm	(3)	(4)	(3)	(3)	(4)
USF/DAS-8 to 9	dBm	(3)	-100,0	(3)	(3)	-100,0
USF/DAS-10 to 12	dBm	(3)	-99,0	(3)	(3)	-99,0

Performance is specified at 30% BLER for those cases identified with mark **.

NOTE 1: Ideal FH case assumes perfect decorrelation between bursts. This case may only be tested if such a decorrelation is ensured in the test. For TU50 (ideal FH), sufficient decorrelation may be achieved with 4 frequencies spaced over 5 MHz.

NOTE 2: PDTCH for DAS-x can not meet the reference performance for some propagation conditions (*).

NOTE 3: The requirements for the DCS 1800 & PCS 1900 Static propagation condition are the same as for the GSM 850 & GSM 900 Static propagation condition, the requirements for DCS 1800 & PCS 1900 TU50 (ideal FH) propagation conditions are the same as for the DCS 1800 & PCS 1900 TU50 (no FH) propagation condition, and the requirements for the DCS 1800 & PCS 1900 RA130 (no FH) propagation condition are the same as for the GSM 850 & GSM 900 RA250 (no FH) propagation condition.

NOTE 4: The requirements for USF/DAS-5 to 7 are the same as for USF/MCS-5 to 9.

Table 1m: Input signal level (for normal BTS) at reference performance for QPSK, 16-QAM and 32-QAM modulated signals (Higher symbol rate and BTTI) (EGPRS2-B UL)

		GSM 900 and GSM 850					
Type of channel		Propagation conditions					
		static	TU50 (no FH)	TU50 (ideal FH)	RA250 (no FH)	HT100 (no FH)	
Wanted signal Wide	PDTCH/UBS-5	dBm	-104,0	-104,0 / [tbd]	-104,0 / [tbd]	-104,0 / [tbd]	-104,0 / [tbd]
	PDTCH/UBS-6	dBm	-104,0	-104,0 / [tbd]	-104,0 / [tbd]	-104,0 / [tbd]	-103,5 / [tbd]
	PDTCH/UBS-7	dBm	-101,0	-99,5 / [tbd]	-100,5 / [tbd]	-101,5 / [tbd]	-98,5 / [tbd]
	PDTCH/UBS-8	dBm	-99,5	-97,5 / [tbd]	-98,5 / [tbd]	-99,5 / [tbd]	-95,5 / [tbd]
	PDTCH/UBS-9	dBm	-98,5	-96,5 / [tbd]	-97,0 / [tbd]	-97,5 / [tbd]	-93,0 / [tbd]
	PDTCH/UBS-10	dBm	-95,0	-92,5 / [tbd]	-93,0 / [tbd]	-93,0 / [tbd]	-93,5** / [tbd]
	PDTCH/UBS-11	dBm	-93,0	-90,0 / [tbd]	-90,0 / [tbd]	-92,5** / [tbd]	-89,5** / [tbd]
	PDTCH/UBS-12	dBm	-91,5	-88,5 / [tbd]	-88,5 / [tbd]	-90,0** / [tbd]	* / [tbd]
Wanted signal Narrow	PDTCH/UBS-5	dBm	-103,5	-	-103,5 / [tbd]	-	-103,5 / [tbd]
	PDTCH/UBS-6	dBm	-101,5	-	-101,5 / [tbd]	-	-101,0 / [tbd]
	PDTCH/UBS-7	dBm	-95,0	-	-95,0 / [tbd]	-	-92,5 / [tbd]
	PDTCH/UBS-8	dBm	-93,0	-	-92,5 / [tbd]	-	-88,0 / [tbd]
	PDTCH/UBS-9	dBm	-91,5	-	-91,5 / [tbd]	-	-85,0 / [tbd]
	PDTCH/UBS-10	dBm	-88,0	-	-87,0 / [tbd]	-	* / [tbd]
	PDTCH/UBS-11	dBm	-85,5	-	-82,0 / [tbd]	-	* / [tbd]
	PDTCH/UBS-12	dBm	-84,5	-	-80,0 / [tbd]	-	* / [tbd]

(To be continued)

Table 1m: Input signal level (for normal BTS) at reference performance for QPSK, 16-QAM and 32-QAM modulated signals (Higher symbol rate and BTTI) (EGPRS2-B UL) (continued)

DCS 1 800 and PCS 1900							
Type of channel			Propagation conditions				
			static	TU50 (no FH)	TU50 (ideal FH)	RA130 (no FH)	HT100 (no FH)
Wanted signal Wide	PDTCH/UBS-5	dBm	(3)	-104,0 / [tbd]	(3)	(3)	-104,0 / [tbd]
	PDTCH/UBS-6	dBm	(3)	-104,0 / [tbd]	(3)	(3)	-104,0 / [tbd]
	PDTCH/UBS-7	dBm	(3)	-100,5 / [tbd]	(3)	(3)	-97,5 / [tbd]
	PDTCH/UBS-8	dBm	(3)	-98,5 / [tbd]	(3)	(3)	-97,0 / [tbd]
	PDTCH/UBS-9	dBm	(3)	-97,0 / [tbd]	(3)	(3)	-94,5 / [tbd]
	PDTCH/UBS-10	dBm	(3)	-92,5 / [tbd]	(3)	(3)	-91,5** / [tbd]
	PDTCH/UBS-11	dBm	(3)	-88,5 / [tbd]	(3)	(3)	* / [tbd]
	PDTCH/UBS-12	dBm	(3)	-86,5 / [tbd]	(3)	(3)	* / [tbd]
Wanted signal Narrow	PDTCH/UBS-5	dBm	(3)	-	(4)	-	-103,5 / [tbd]
	PDTCH/UBS-6	dBm	(3)	-	(4)	-	-101,0 / [tbd]
	PDTCH/UBS-7	dBm	(3)	-	(4)	-	-89,5 / [tbd]
	PDTCH/UBS-8	dBm	(3)	-	(4)	-	-92,0** / [tbd]
	PDTCH/UBS-9	dBm	(3)	-	(4)	-	-88,5** / [tbd]
	PDTCH/UBS-10	dBm	(3)	-	(4)	-	* / [tbd]
	PDTCH/UBS-11	dBm	(3)	-	(4)	-	* / [tbd]
	PDTCH/UBS-12	dBm	(3)	-	(4)	-	* / [tbd]
Performance is specified at 30% BLER for those cases identified with mark **.							
NOTE 1: Ideal FH case assumes perfect decorrelation between bursts. This case may only be tested if such a decorrelation is ensured in the test. For TU50 (ideal FH), sufficient decorrelation may be achieved with 4 frequencies spaced over 5 MHz.							
NOTE 2: PDTCH for UBS-x can not meet the reference performance for some propagation conditions (*).							
NOTE 3: The requirements for the DCS 1800 & PCS 1900 Static propagation condition are the same as for the GSM 850 & GSM 900 Static propagation condition, the requirements for DCS 1800 & PCS 1900 TU50 (ideal FH) propagation conditions are the same as for the DCS 1800 & PCS 1900 TU50 (no FH) propagation condition, and the requirements for the DCS 1800 & PCS 1900 RA130 (no FH) propagation condition are the same as for the GSM 850 & GSM 900 RA250 (no FH) propagation condition.							
NOTE 4: The requirements for the DCS 1800 & PCS 1900 TU50 (ideal FH) propagation condition are the same as for the GSM 850 & GSM 900 TU50 (ideal FH) propagation condition.							
NOTE 5: For non-static conditions RX diversity requirements are given by the left numbers. Requirements without RX diversity are given by the right numbers.							

Table 1n: Input signal level (for MS) at reference performance for QPSK, 16-QAM and 32-QAM modulated signals (Higher symbol rate, BTTI and turbo coding) (EGPRS2-B DL)

GSM 900 and GSM 850						
Type of channel		Propagation conditions				
		static	TU50 (no FH)	TU50 (ideal FH)	RA250 (no FH)	HT100 (no FH)
PDTCH/DBS-5	dBm	-100,5	-94,5	-95,0	-98,0	-95,0
PDTCH/DBS-6	dBm	-100,0	-92,5	-92,5	-94,5	-90,0
PDTCH/DBS-7	dBm	-93,5	-88,0	-89,0	-90,0	*
PDTCH/DBS-8	dBm	-92,0	-85,5	-86,0	-85,0	*
PDTCH/DBS-9	dBm	-90,5	-83,0	-83,5	-80,0	*
PDTCH/DBS-10	dBm	-86,5	-77,5	-78,0	*	*
PDTCH/DBS-11	dBm	-84,5	-78,0**	-79,5**	*	*
PDTCH/DBS-12	dBm	-80,5	-75,0**	-76,0**	*	*
USF/DBS-5 to 6	dBm	[-104,0]	[-102,0]	[-102,5]	[-103,5]	[-102,5]
USF/DBS-7 to 9	dBm	[-104,0]	[-104,0]	[-104,0]	[-104,0]	[-104,0]
USF/DBS-10 to 12	dBm	[-104,0]	[-104,0]	[-104,0]	[-104,0]	[-104,0]

(To be continued)

Table 1n: Input signal level (for MS) at reference performance for QPSK, 16-QAM and 32-QAM modulated signals (Higher symbol rate, BTTI and turbo coding) (EGPRS2-B DL) (continued)

DCS 1 800 and PCS 1900						
Type of channel		Propagation conditions				
		static	TU50 (no FH)	TU50 (ideal FH)	RA130 (no FH)	HT100 (no FH)
PDTCH/DBS-5	dBm	(3)	-94,5	(3)	(3)	-94,0
PDTCH/DBS-6	dBm	(3)	-92,0	(3)	(3)	-87,5
PDTCH/DBS-7	dBm	(3)	-88,0	(3)	(3)	*
PDTCH/DBS-8	dBm	(3)	-84,5	(3)	(3)	*
PDTCH/DBS-9	dBm	(3)	-83,0	(3)	(3)	*
PDTCH/DBS-10	dBm	(3)	-75,0	(3)	(3)	*
PDTCH/DBS-11	dBm	(3)	-75,0	(3)	(3)	*
PDTCH/DBS-12	dBm	(3)	*	(3)	(3)	*
USF/DBS-5 to 6	dBm	(3)	[-103,0]	(3)	(3)	[-103,0]
USF/DBS-7 to 9	dBm	(3)	[-104,0]	(3)	(3)	[-104,0]
USF/DBS-10 to 12	dBm	(3)	[-104,0]	(3)	(3)	[-104,0]

Performance is specified at 30% BLER for those cases identified with mark **.

NOTE 1: Ideal FH case assumes perfect decorrelation between bursts. This case may only be tested if such a decorrelation is ensured in the test. For TU50 (ideal FH), sufficient decorrelation may be achieved with 4 frequencies spaced over 5 MHz.

NOTE 2: PDTCH for DBS-x can not meet the reference performance for some propagation conditions (*).

NOTE 3: The requirements for the DCS 1800 & PCS 1900 Static propagation condition are the same as for the GSM 850 & GSM 900 Static propagation condition, the requirements for DCS 1800 & PCS 1900 TU50 (ideal FH) propagation conditions are the same as for the DCS 1800 & PCS 1900 TU50 (no FH) propagation condition, and the requirements for the DCS 1800 & PCS 1900 RA130 (no FH) propagation condition are the same as for the GSM 850 & GSM 900 RA250 (no FH) propagation condition.

Table 1o: Input signal level (for MS) at reference performance for GMSK, QPSK, 8-PSK, 16-QAM and 32-QAM modulated signals with PAN included; BTTI and RTTI (EGPRS2 DL and EGPRS DL)

All GSM bands		
Type of channel		Propagation conditions
		Static
PDTCH/MCS -1	dBm	-104,0
PDTCH/MCS-2	dBm	-104,0
PDTCH/MCS-3	dBm	-101,5
PDTCH/MCS-5	dBm	-99,0
PDTCH/MCS-6	dBm	-97,0
PDTCH/MCS-7	dBm	-94,0
PDTCH/MCS-8	dBm	-90,5
PDTCH/DAS-5	dBm	-100,0
PDTCH/DAS-6	dBm	-99,0
PDTCH/DAS-7	dBm	-97,5
PDTCH/DAS-8	dBm	-95,5
PDTCH/DAS-9	dBm	-94,0
PDTCH/DAS-10	dBm	-91,0
PDTCH/DAS-11	dBm	-89,0
PDTCH/DAS-12	dBm	-84,5
PDTCH/DBS-5	dBm	[-102,5]
PDTCH/DBS-6	dBm	[-100,5]
PDTCH/DBS-7	dBm	[-97,0]
PDTCH/DBS-	dBm	[-94,5]
PDTCH/DBS-9	dBm	[-92,5]
PDTCH/DBS-10	dBm	[-88,5]
PDTCH/DBS-11	dBm	[-84,0]
PDTCH/DBS-12	dBm	[-77,5]

**Table 1p: Input signal level (for normal BTS) at reference performance for GMSK, QPSK, 8-PSK, 16-QAM and 32-QAM modulated signals with PAN included;
BTI and RTTI
(EGPRS2 UL and EGPRS UL)**

All GSM bands		
Type of channel		Propagation condition
		Static
PDTCH/MCS-1	dBm	-104
PDTCH/MCS-2	dBm	-104
PDTCH/MCS-3	dBm	-104
PDTCH/MCS-5	dBm	-101
PDTCH/MCS-6	dBm	-99,5
PDTCH/MCS-7	dBm	-96
PDTCH/MCS-8	dBm	-93
PDTCH/UAS-7	dBm	-97
PDTCH/UAS-8	dBm	-96,5
PDTCH/UAS-9	dBm	-95,5
PDTCH/UAS-10	dBm	-94,5
PDTCH/UAS-11	dBm	-92,5
PDTCH/UBS-5	dBm	-104
PDTCH/UBS-6	dBm	-104
PDTCH/UBS-7	dBm	-101
PDTCH/UBS-8	dBm	-99,5
PDTCH/UBS-9	dBm	-98,5
PDTCH/UBS-10	dBm	-95
PDTCH/UBS-11	dBm	-92
PDTCH/UBS-12	dBm	-89,5

Table 1q: Input signal level (for normal BTS) at reference performance of PAN for GMSK, QPSK, 8-PSK, 16-QAM and 32-QAM modulated signals (EGPRS2 UL and EGPRS UL); BTTI and RTTI

All GSM bands		
Type of channel		Propagation conditions
		Static
PDTCH/MCS-1 to 3	dBm	-104
PDTCH/MCS-5 to 6	dBm	-104
PDTCH/MCS-7	dBm	-104
PDTCH/MCS-8	dBm	-104
PDTCH/UAS-7 to 9	dBm	-104
PDTCH/UAS-10	dBm	-104
PDTCH/UAS-11	dBm	-104
PDTCH/UBS-5 to 6	dBm	-104
PDTCH/UBS-7 to 8	dBm	-104
PDTCH/UBS-9	dBm	-104
PDTCH/UBS-10	dBm	-104
PDTCH/UBS-11 to 12	dBm	-104

Table 1r: Input signal level (for MS) at reference performance of PAN for GMSK, QPSK, 8-PSK, 16-QAM and 32-QAM modulated signals (EGPRS2 DL and EGPRS DL) ; BTTI and RTTI

All GSM bands		
Type of channel		Propagation conditions
		Static
PDTCH/MCS-1 to 3	dBm	-104,0
PDTCH/MCS-5 to 6	dBm	-101,5
PDTCH/MCS-7	dBm	-101,0
PDTCH/MCS-8	dBm	-100,5
PDTCH/DAS-5 to 7	dBm	(note 1)
PDTCH/DAS-8 to 9	dBm	-101,0
PDTCH/DAS-10	dBm	-99,0
PDTCH/DAS-11	dBm	-98,0
PDTCH/DAS-12	dBm	-98,0
PDTCH/DBS-5 to 6	dBm	[-104,0]
PDTCH/DBS-7 to 8	dBm	[-101,0]
PDTCH/DBS-9	dBm	[-101,0]
PDTCH/DBS-10	dBm	[-97,5]
PDTCH/DBS-11 to 12	dBm	[-95,0]

Note 1: The requirement for PDTCH/DAS-5 to 7 is the same as PDTCH/MCS-5 to 6.

Table 1s: Input signal level for VAMOS I MS at reference performance for speech channels in VAMOS mode

Type of channel		Propagation conditions: TU50 no FH					
		GSM 900 and GSM 850			DCS 1800 & PCS 1900		
SCPIR_DL		+4 dB	0 dB	-4 dB	+4 dB	0 dB	-4 dB
TCH/HS	FER (dBm)	-99	-96,5	-92,5	-98,5	-96	-92,5
	RBER1b	0,31 %	0,2 %	0,2%	0,27 %	0,27 %	0,2 %
TCH/EFS	RBER2	5,7 %	6,1 %	5,6 %	5,4 %	5,3 %	5,5 %
	FER (dBm)	-97,5	-95	-92	-98,5	-96	-92,5
	RBER1b	0,04 %	0,05 %	0,05 %	0,05 %	0,05 %	0,1 %

TCH/AFS12.2	RBER2	3,6 %	4,2 %	4,01 %	4,5 %	5,3 %	5 %
	FER (dBm)	-97,5	-94,5	-91,5	-98,5	-96	-92,5
TCH/AFS4.75	RBER1b	0,6 %	0,5 %	0,6 %	0,7 %	0,9 %	0,7 %
	FER (dBm)	-103	-101	-98	-104	-101,5	-98,5
TCH/AHS7.4	RBER1b	0,1 %	0,15 %	0,17 %	0,17 %	0,15 %	0,2 %
	FER (dBm)	-95	-92,5	-89	-95	-92	-88,5
TCH/AHS4.75	RBER1b	0,15 %	0,2 %	0,17 %	0,15 %	0,2 %	0,2 %
	RBER2	1,8 %	2,3 %	2 %	1,7 %	2,3 %	2 %
TCH/WFS12.65	FER (dBm)	-99,5	-97	-94	-100	-96,5	-93,5
	RBER1b	0,2 %	0,2 %	0,2 %	0,16 %	0,15 %	0,2 %
TCH/WFS6.60	RBER2	5,88 %	6,6 %	6,74 %	5,9 %	5,9 %	6 %
	FER (dBm)	-97,5	-94,5	-91,5	-98,5	-96	-92,5
FACCH/F	RBER1b	0,4 %	0,4 %	0,3 %	0,6 %	0,7 %	0,5 %
	FER (dBm)	-101	-98,5	-94	-102	-99,5	-96,5
FACCH/H	RBER1b	0,2 %	0,26 %	0,23 %	0,25 %	0,36 %	0,32 %
	FER	-100	-97	-93,5	-100,5	-98	-94,5
SACCH	FER	-100	-97	-94	-100	-97	-94
	FER	-100	-97	-93,5	-100	-97	-93,5
Repeated FACCH/F	FER	-	-98,5	-	-	-99	-
	FER	-	-100,5	-	-	-100,5	-

Table 1t: Input signal level for VAMOS II MS at reference performance for speech channels in VAMOS mode

GSM 900 and GSM 850						
Type of channel		Propagation conditions				
		TU50 no FH				
SCPIR_DL		+4 dB	0 dB	-4 dB	-8 dB	-10 dB
TCH/HS	FER (dBm)	-100	-97,5	-96,5	-93,5	-91,5
	RBER1b	0,12 %	0,12 %	0,11 %	0,15 %	0,15 %
TCH/EFS	RBER2	5,27 %	4,94 %	4,84 %	5,65 %	5,98 %
	FER (dBm)	-99	-97	-96	-92,5	-90,5
TCH/AFS12.2	RBER1b	0,03 %	0,03 %	0,06 %	0,04 %	0,03 %
	RBER2	4,31 %	3,93 %	4,21 %	4,52 %	4,81 %
TCH/AFS4.75	FER (dBm)	-99,5	-97	-95,5	-92,5	-91
	RBER1b	0,74 %	0,62 %	0,46 %	0,51 %	0,93 %
TCH/AHS7.4	FER (dBm)	-104,5	-103	-101,5	-98,5	-96,5
	RBER1b	0,11 %	0,17 %	0,15 %	0,15 %	0,11 %
TCH/AHS4.75	FER (dBm)	-97	-94,5	-93	-90,5	-88
	RBER1b	0,26 %	0,22 %	0,12 %	0,23 %	0,25 %
TCH/WFS12.65	RBER2	2,67 %	2,41 %	1,91 %	2,77 %	2,95 %
	FER (dBm)	-101	-99	-97,5	-94,5	-92,5
TCH/WFS6.60	RBER1b	0,12 %	0,19 %	0,14 %	0,16 %	0,13 %
	RBER2	6,1 %	6,63 %	6,01 %	6,2 %	6,9 %
FACCH/F	FER (dBm)	-99	-97	-95,5	-92,5	-91
	RBER1b	0,35 %	0,51 %	0,36 %	0,38 %	0,66 %
FACCH/H	FER (dBm)	-102	-99,5	-99	-96,5	-94,5
	RBER1b	0,25 %	0,24 %	0,17 %	0,27 %	0,17 %
SACCH	FER	-100	-97,5	-96	-93,5	-91,5
	FER	-100	-98	-96,5	-93,5	-91,5
Repeated FACCH/F	FER	-100	-97,5	-96	-93	-91
	FER	-	-101	-	-	-
Repeated SACCH	FER	-	-102,5	-	-	-

DCS 1800 & PCS 1900						
Type of channel		Propagation conditions				
		TU50 no FH				
SCPIR_DL		+4 dB	0 dB	-4 dB	-8 dB	-10 dB
TCH/HS	FER (dBm)	-99	-97	-95,5	-91,5	-90
	RBER1b	0,23 %	0,17 %	0,2 %	0,21 %	0,23 %
	RBER2	6,01 %	5,57 %	5,5 %	5,68 %	5,98 %
TCH/EFS	FER (dBm)	-99,5	-98	-96	-92,5	-90,5
	RBER1b	0,07 %	0,06 %	0,06 %	0,06 %	0,06 %
	RBER2	5,18 %	5,13 %	5,09 %	5,66 %	6,14 %
TCH/AFS12.2	FER (dBm)	-99,5	-98	-96	-92,5	-90,5
	RBER1b	0,94 %	1,06 %	0,77 %	0,92 %	0,94 %
TCH/AFS4.75	FER (dBm)	-105,5	-103,5	-101,5	-98	-96,5
	RBER1b	0,2 %	0,17 %	0,18 %	0,16 %	0,2 %
TCH/AHS7.4	FER (dBm)	-96	-94,5	-92	-88,5	-86
	RBER1b	0,17 %	0,24 %	0,16 %	0,18 %	0,22 %
	RBER2	1,9 %	2,35 %	1,79 %	2,46 %	2,85 %
TCH/AHS4.75	FER (dBm)	-100,5	-98,5	-96,5	-93	-91
	RBER1b	0,17 %	0,15 %	0,12 %	0,15 %	0,15 %
	RBER2	6,12 %	5,79 %	5,76 %	6,55 %	6,6 %
TCH/WFS12.65	FER (dBm)	-99,5	-98	-96	-92,5	-90,5
	RBER1b	0,53 %	0,82 %	0,59 %	0,64 %	0,72 %
TCH/WFS6.60	FER (dBm)	-103,5	-100	-99,5	-96,5	-94,5
	RBER1b	0,33 %	0,31 %	0,18 %	0,24 %	0,26 %
FACCH/F	FER	-100,5	-98,5	-97	-94	-92
FACCH/H	FER	-100	-98	-96,5	-93	-91
SACCH	FER	-100	-97,5	-96	-92,5	-90,5
Repeated FACCH/F	FER	-	-101,5	-	-	-
Repeated SACCH	FER	-	-102,5	-	-	-

Table 1u: Performance requirement for VAMOS II MS for downlink DTX scenario according to subclause Q.6

SCPIR_DL = -10 dB, TU 50 noFH			
Type of channel		GSM 900 and GSM 850	DCS 1800 & PCS 1900
TCH/AHS 7.4	FER (dBm)	-88	-87
	RBER1b (%)	0,25	0,28
	RBER2 (%)	2,28	2,7

Table 1v: Input signal level for normal BTS at reference performance for speech and associated control channels in VAMOS mode

Type of channel		Propagation conditions: TU 50 no FH			
		GSM 900 and GSM 850		DCS 1800 & PCS 1900	
SCPIR_UL		0 dB	-10 dB	0 dB	-10 dB
TCH/HS	FER (dBm)	-108	-108,5	-107,5	-108
	Rber1b	0.21%	0.16%	0.19%	0.15%
	Rber2	5.48%	5.00%	5.10%	5.00%
TCH/EFS	FER (dBm)	-106.5	-107	-106.5	-106.5
	Rber1b	0.04%	0.04%	0.04%	0.04%
	Rber2	3.52%	3.60%	3.95%	4.20%
TCH/AFS 12.2	FER (dBm)	-106.5	-107.5	-106.5	-107
	Rber1b	0.45%	0.52%	0.60%	0.67%

TCH/AFS 4.75	FER (dBm)	-112	-	-113	-
	Rber1b	0.14%	-	0.17%	-
TCH/AHS 7.4	FER (dBm)	-104	-105	-103.5	-103.5
	Rber1b	0.16%	0.18%	0.16%	0.29%
	Rber2	1.54%	2.10%	1.55%	2.12%
TCH/AHS 4.75	FER (dBm)	-108.5	-	-108.5	-
	Rber1b	0.18%	-	0.18%	-
	Rber2	6.30%	-	6.59%	-
TCH/WFS 12.65	FER (dBm)	-106.5	-107.5	-106.5	-107
	Rber1b	0.40%	0.40%	0.41%	0.48%
TCH/WFS 6.60	FER (dBm)	-110.5	-	-111	-
	Rber1b	0.20%	-	0.21%	-
FACCH/F	FER	-108.5	-	-109	-
FACCH/H	FER	-108.5	-	-108.5	-
SACCH	FER	-108.5	-	-108.5	-
Repeated SACCH	FER	-113.5	-	-113	-

Table 1w: Input signal level (for MS) at reference performance for TIGHTER

Type of Channel		GSM 900 and GSM 850				
		Propagation conditions				
		Static	TU50 (no FH)	TU50 (ideal FH)	RA250 (no FH)	HT100 (no FH)
FACCH/H	dBm	-110	-106	-106	-106,5	-105
FACCH/F	dBm	-110	-105,5	-106,5	-106,5	-105,5
SDCCH	dBm	-110	-104,5	-105,5	-105,5	-104,5
SCH	dBm	-110	-101	-101	-98	-100,5
TCH/FS	dBm	-109,5	-103	-105	-105	-103
	RBBER1b (%)	0,07	0,06	0,07	0,07	0,06
	RBBER2 (%)	6,58	4,1	6,13	6,55	5,49
TCH/EFS	dBm	-109	-103	-105	-105	-103,5
	RBBER1b (%)	0,03	0,03	0,09	0,06	0,04
	RBBER2 (%)	6,22	3,29	5,87	6,19	5,34
TCH/HS	dBm	-109,5	-104	-104	-104	-102,5
	RBBER1b (%)	0,2	0,24	0,22	0,15	0,22
	RBBER2 (%)	5,48	5,09	5,76	5,83	5,12
TCH/AFS12.2	dBm	-109,5	⁽⁴⁾	-105	-105,5	-104
	RBBER1b (%)	2,12	⁽⁴⁾	0,88	1,38	1,12
TCH/AFS10.2	dBm	-110	⁽⁴⁾	-106	-106,5	-105
	RBBER1b (%)	0,5	⁽⁴⁾	0,15	0,31	0,18
TCH/AFS7.95	dBm	-	⁽⁴⁾	-108	-108,5	-107
	RBBER1b (%)	-	⁽⁴⁾	0,37	0,57	0,41
TCH/AFS7.4	dBm	-	⁽⁴⁾	-108	-108,5	-107
	RBBER1b (%)	-	⁽⁴⁾	0,17	0,18	0,17
TCH/AFS6.7	dBm	-	⁽⁴⁾	-108,5	-109	-108
	RBBER1b (%)	-	⁽⁴⁾	0,63	0,79	0,58
TCH/AFS5.9	dBm	-	⁽⁴⁾	-109	-109,5	-108,5
	RBBER1b (%)	-	⁽⁴⁾	0,156	0,19	0,19
TCH/AFS5.15	dBm	-	⁽⁴⁾	-109,5	-110	-109
	RBBER1b (%)	-	⁽⁴⁾	0,23	0,32	0,33
TCH/AFS4.75	dBm	-	⁽⁴⁾	-110	-110	-108,5
	RBBER1b (%)	-	⁽⁴⁾	0,19	0,16	0,15
TCH/AHS7.95	dBm	-107,5	⁽⁴⁾	-101	-98,5	-99
	RBBER1b (%)	0,79	⁽⁴⁾	0,44	0,44	0,43
	RBBER2 (%)	3,58	⁽⁴⁾	2,06	1,91	2
TCH/AHS7.4	dBm	-108	⁽⁴⁾	-101,5	-99,5	-100
	RBBER1b (%)	0,44	⁽⁴⁾	0,23	0,19	0,23
	RBBER2 (%)	4,14	⁽⁴⁾	2,49	2,35	2,37
TCH/AHS6.7	dBm	-109	⁽⁴⁾	-102,5	-101,5	-101,5
	RBBER1b (%)	0,58	⁽⁴⁾	0,3	0,29	0,28
	RBBER2 (%)	5,51	⁽⁴⁾	3,44	3,42	3,35
TCH/AHS5.9	dBm	-109,5	⁽⁴⁾	-103,5	-103	-102,5
	RBBER1b (%)	0,33	⁽⁴⁾	0,17	0,17	0,17
	RBBER2 (%)	6,59	⁽⁴⁾	4,27	4,24	4,08
TCH/AHS5.15	dBm	-110	⁽⁴⁾	-104,5	-104,5	-104
	RBBER1b (%)	0,78	⁽⁴⁾	0,25	0,33	0,32
	RBBER2 (%)	8,36	⁽⁴⁾	5,16	5,82	5,41
TCH/AHS4.75	dBm	-111	⁽⁴⁾	-105	-104,5	-103,5
	RBBER1b (%)	0,38	⁽⁴⁾	0,14	0,13	0,13
	RBBER2 (%)	10,33	⁽⁴⁾	6,32	5,99	5,91
TCH/WFS12.65	dBm	-109	-103,5	⁽³⁾	-105	-102
	RBBER1b (%)	0,5	0,35	⁽³⁾	0,72	0,62
TCH/ WFS8.85	dBm	-109	-102	⁽³⁾	-108	-105
	RBBER1b (%)	0,5	0,38	⁽³⁾	0,72	0,62
TCH/ WFS6.60	dBm	-109	-103	⁽³⁾	-108	-106,5

	RB ER1b (%)	0,24	0,15	⁽³⁾	0,19	0,24
PDTCH/CS-1	dBm	-105	-106	-106	-105,5	-104,5
PDTCH/CS-2	dBm	-105	-102	-103	-102,5	-100,5
PDTCH/CS-3	dBm	-105	-100	-101	-99,5	-97,5
PDTCH/CS-4	dBm	-102	-92	-92	-	-
PDTCH/MCS-1	dBm	-105,5	-105	-105,5	-105,5	-103
PDTCH/MCS-2	dBm	-105,5	-103	-103,5	-103	-101
PDTCH/MCS-3	dBm	-105,5	-99	-99	-95	-96,5
PDTCH/MCS-4	dBm	-103	-93,5	-93,5	-	-
PDTCH/MCS-5	dBm	-101,5	-97,5	-98,5	-99	-97,5
PDTCH/MCS-6	dBm	-99,5	-95,5	-96	-94	-94,5
PDTCH/MCS-7	dBm	-96,5	-88,5	-88,5	-	-88,5**
PDTCH/MCS-8	dBm	-94	-87,5**	-87,5**	-	-
PDTCH/MCS-9	dBm	-89,5	-83**	-83**	-	-
PDTCH/DAS-5	dBm	[-103,5]	[-97,5]	[-98]	[-98,5]	[-98]
PDTCH/DAS-6	dBm	[-102]	[-96,5]	[-97,5]	[-97]	[-96,5]
PDTCH/DAS-7	dBm	[-101]	[-95,5]	[-96]	[-94,5]	[-94]
PDTCH/DAS-8	dBm	[-98]	[-93]	[-93,5]	[-91,5]	[-88,5]
PDTCH/DAS-9	dBm	[-97]	[-90,5]	[-91]	[-85,5]	[-90,5**]
PDTCH/DAS-10	dBm	[-93,5]	[-87,5]	[-88]	[-87**]	-
PDTCH/DAS-11	dBm	[-91,5]	[-82,5]	[-83]	-	-
PDTCH/DAS-12	dBm	[-87,5]	[-80**]	[-80**]	-	-
PDTCH/DBS-5	dBm	[-103,5]	[-99]	[-100]	[-98]	[-98,5]
PDTCH/DBS-6	dBm	[-103]	[-97]	[-97,5]	[-94,5]	[-93,5]
PDTCH/DBS-7	dBm	[-96]	[-91,5]	[-92]	[-90] ⁽⁵⁾	-
PDTCH/DBS-8	dBm	[-94,5]	[-89]	[-89]	[-85] ⁽⁵⁾	-
PDTCH/DBS-9	dBm	[-93]	[-86,5]	[-86,5]	[-80] ⁽⁵⁾	-
PDTCH/DBS-10	dBm	[-89]	[-80,5]	[-78] ⁽⁵⁾	-	-
PDTCH/DBS-11	dBm	[-87]	[-81**]	[-79,5**] ⁽⁵⁾	-	-
PDTCH/DBS-12	dBm	[-83]	[-78**]	[-76**] ⁽⁵⁾	-	-
(Continued)						

Table 1w (continued): Input signal level (for MS) at reference performance for TIGHTER

Type of channel		DCS 1 800 and PCS 1900				
		Propagation conditions				
		Static	TU50 (no FH)	TU50 (ideal FH)	RA130 (no FH)	HT100 (no FH)
FACCH/H	dBm	(3)	-106	-106	-106,5	-105
FACCH/F	dBm	(3)	-106	-106,5	-106,5	-105,5
SDCCH	dBm	(3)	-105	-105,5	-105,5	-104,5
SCH	dBm	(3)	-100,5	-100,5	-98	-100
TCH/FS	dBm	(3)	-104	-104	-104	-102,5
	RBBER1b (%)	(3)	0,06	0,06	0,04	0,06
	RBBER2 (%)	(3)	5,44	5,72	5,75	5,64
TCH/EFS	dBm	(3)	-104	-104,5	-104,5	-103
	RBBER1b (%)	(3)	0,04	0,11	0,06	0,18
	RBBER2 (%)	(3)	4,92	6,17	6,07	6,85
TCH/HS	dBm	(3)	-104	-104	-103,5	-102,5
	RBBER1b (%)	(3)	0,21	0,22	0,15	0,22
	RBBER2 (%)	(3)	5,95	5,87	4,87	5,26
TCH/AFS12.2	dBm	(3)	(4)	-105	-105,5	-103,5
	RBBER1b (%)	(3)	(4)	1,23	1,38	0,9
TCH/AFS10.2	dBm	(3)	(4)	-106	-106,5	-105
	RBBER1b (%)	(3)	(4)	0,17	0,3	0,27
TCH/AFS7.95	dBm	(3)	(4)	-108	-108,5	-107
	RBBER1b (%)	(3)	(4)	0,36	0,57	0,42
TCH/AFS7.4	dBm	(3)	(4)	-108	-108,5	-107
	RBBER1b (%)	(3)	(4)	0,17	0,27	0,15
TCH/AFS6.7	dBm	(3)	(4)	-108,5	-109	-108
	RBBER1b (%)	(3)	(4)	0,62	0,79	0,62
TCH/AFS5.9	dBm	(3)	(4)	-109	-109,5	-108,5
	RBBER1b (%)	(3)	(4)	0,15	0,19	0,23
TCH/AFS5.15	dBm	(3)	(4)	-109,5	-110	-109
	RBBER1b (%)	(3)	(4)	0,23	0,32	0,33
TCH/AFS4.75	dBm	(3)	(4)	-110	-110	-108,5
	RBBER1b (%)	(3)	(4)	0,2	0,2	0,19
TCH/AHS7.95	dBm	(3)	(4)	-100,5	-98,5	-98,5
	RBBER1b (%)	(3)	(4)	0,44	0,4	0,47
	RBBER2 (%)	(3)	(4)	2,08	1,8	2,11
TCH/AHS7.4	dBm	(3)	(4)	-101,5	-99,5	-99,5
	RBBER1b (%)	(3)	(4)	0,22	0,14	0,23
	RBBER2 (%)	(3)	(4)	2,51	2,08	2,58
TCH/AHS6.7	dBm	(3)	(4)	-102,5	-101,5	-101
	RBBER1b (%)	(3)	(4)	0,31	0,3	0,29
	RBBER2 (%)	(3)	(4)	3,51	3,0	3,54
TCH/AHS5.9	dBm	(3)	(4)	-103,5	-103	-102,5
	RBBER1b (%)	(3)	(4)	0,17	0,17	0,19
	RBBER2 (%)	(3)	(4)	4,31	4,22	4,26
TCH/AHS5.15	dBm	(3)	(4)	-104,5	-104,5	-103,5
	RBBER1b (%)	(3)	(4)	0,25	0,23	0,34
	RBBER2 (%)	(3)	(4)	5,18	5,32	5,56
TCH/AHS4.75	dBm	(3)	(4)	-105	-104,5	-103,5
	RBBER1b (%)	(3)	(4)	0,14	0,15	0,15
	RBBER2 (%)	(3)	(4)	6,35	5,95	5,98
TCH/WFS12.65	dBm	(3)	-104,5	(3)	(3)	-102
	RBBER1b (%)	(3)	0,62	(3)	(3)	0,66
TCH/ WFS8.85	dBm	(3)	-107,5	(3)	(3)	-105
	RBBER1b (%)	(3)	0,59	(3)	(3)	0,58
TCH/ WFS6.60	dBm	(3)	-108	(3)	(3)	-106,5

	RBBER1b (%)	(3)	0,17	(3)	(3)	0,25
PDTCH/CS-1	dBm	(3)	-106	-106	-105,5	-104,5
PDTCH/CS-2	dBm	(3)	-102	-102	-102,5	-100,5
PDTCH/CS-3	dBm	(3)	-100	-100	-99,5	-95,5
PDTCH/CS-4	dBm	(3)	-90	-90	-	-
PDTCH/MCS-1	dBm	(3)	-104,5	-105,5	-105,5	-102,5
PDTCH/MCS-2	dBm	(3)	-102,5	-103,5	-103	-100,5
PDTCH/MCS-3	dBm	(3)	-98,5	-99	-95	-95,5
PDTCH/MCS-4	dBm	(3)	-92,5	-93	-	-
PDTCH/MCS-5	dBm	(3)	-98,5	-98,5	-99	-95
PDTCH/MCS-6	dBm	(3)	-96	-96	-94	-89
PDTCH/MCS-7	dBm	(3)	-86,5	-85,5	-	-
PDTCH/MCS-8	dBm	(3)	-85**	-85**	-	-
PDTCH/MCS-9	dBm	(3)	-	-	-	-
PDTCH/DAS-5	dBm	(3)	[-97,5]	(3)	(3)	[-97,5]
PDTCH/DAS-6	dBm	(3)	[-97]	(3)	(3)	[-95,5]
PDTCH/DAS-7	dBm	(3)	[-95,5]	(3)	(3)	[-89,5]
PDTCH/DAS-8	dBm	(3)	[-93]	(3)	(3)	[-92**]
PDTCH/DAS-9	dBm	(3)	[-90]	(3)	(3)	[-84,5**]
PDTCH/DAS-10	dBm	(3)	[-86]	(3)	(3)	-
PDTCH/DAS-11	dBm	(3)	[-82**]	(3)	(3)	-
PDTCH/DAS-12	dBm	(3)	-	(3)	(3)	-
PDTCH/DBS-5	dBm	(3)	[-99,5]	(3)	(3)	[-98]
PDTCH/DBS-6	dBm	(3)	[-97]	(3)	(3)	[-91,5]
PDTCH/DBS-7	dBm	(3)	[-91]	(3)	(3)	-
PDTCH/DBS-8	dBm	(3)	[-87,5]	(3)	(3)	-
PDTCH/DBS-9	dBm	(3)	[-86]	(3)	(3)	-
PDTCH/DBS-10	dBm	(3)	[-78]	(3)	(3)	-
PDTCH/DBS-11	dBm	(3)	[-78**]	(3)	(3)	-
PDTCH/DBS-12	dBm	(3)	-	(3)	(3)	-

Performance is specified at 30% BLER for those cases identified with mark **.

NOTE 1: Ideal FH case assumes perfect decorrelation between bursts. This case may only be tested if such a decorrelation is ensured in the test. For TU50 (ideal FH), sufficient decorrelation may be achieved with 4 frequencies spaced over 5 MHz.

NOTE 2: PDTCH for MCS-x, DAS-x, and DBS-x can not meet the reference performance for some propagation conditions (-).

NOTE 3: The requirements for the DCS 1800 & PCS 1900 Static propagation condition are the same as for the GSM 850 & GSM 900 Static propagation condition, the requirements for the GSM 850 & GSM 900 TU50 (ideal FH) and DCS 1800 & PCS 1900 TU50 (ideal FH) propagation conditions are the same as for the DCS 1800 & PCS 1900 TU50 (no FH) propagation condition, and the requirements for the DCS 1800 & PCS 1900 RA130 (no FH) propagation condition are the same as for the GSM 850 & GSM 900 RA250 (no FH) propagation condition.

NOTE 4: The TU50 no FH TIGHTER requirement for these TCH are specified as a fixed tightening of the reference sensitivity performance listed in Table 1, which shall be met at an input level less than -105 dBm for GSM 850 & 900 and -105 dBm for DCS 1800 and PCS 1900.

NOTE 5: The requirement is identical to the EGPRS2-B requirement in Table 1n.

Table 2: Reference interference performance for GMSK modulated signals

GSM 850 and GSM 900						
Type of channel	Propagation conditions					
	TU3 (no FH)	TU3 (ideal FH)	TU50 (no FH)	TU50 (ideal FH)	RA250 (no FH)	
FACCH/H (FER)	22 %	6,7 %	6,7 %	6,7 %	5,7 %	
FACCH/F (FER)	22 %	3,4 %	9,5 %	3,4 %	3,5 %	
SDCCH (FER)	22 %	9 %	13 %	9 %	8 %	
RACH (FER)	15 %	15 %	16 %	16 %	13 %	
SCH (FER)	17 %	17 %	17 %	17 %	18 %	
TCH/F14,4 (BER)	10 %	3 %	4,5 %	3 %	3 %	
TCH/F9,6 & H4,8 (BER)	8 %	0,3 %	0,8 %	0,3 %	0,2 %	
TCH/F4,8 (BER)	3 %	10 ⁻⁴	10 ⁻⁴	10 ⁻⁴	10 ⁻⁴	
TCH/F2,4 (BER)	3 %	10 ⁻⁵	10 ⁻⁴	10 ⁻⁵	10 ⁻⁵	
TCH/H2,4 (BER)	4 %	10 ⁻⁴	2 10 ⁻⁴	10 ⁻⁴	10 ⁻⁴	
TCH/FS (FER)	21 α %	3 α %	6 α %	3 α %	3 α %	
class Ib (RBER)	2/ α %	0,2/ α %	0,4/ α %	0,2/ α %	0,2/ α %	
class II (RBER)	4 %	8 %	8 %	8 %	8 %	
TCH/EFS (FER)	23 %	3 %	9 %	3 %	4 %	
(RBER Ib)	0,20 %	0,10 %	0,20 %	0,10 %	0,13 %	
(RBER II)	3 %	8 %	7 %	8 %	8 %	
TCH/HS (FER)	19,1 %	5,0 %	5,0 %	5,0 %	4,7 %	
class Ib (RBER, BFI=0)	0,52 %	0,27 %	0,29 %	0,29 %	0,21 %	
class II (RBER, BFI=0)	2,8 %	7,1 %	7,1 %	7,1 %	7,0 %	
(UFR)	20,7 %	6,2 %	6,1 %	6,1 %	5,6 %	
class Ib (RBER, (BFI or UFI)=0)	0,29 %	0,20 %	0,21 %	0,21 %	0,17 %	
(EVSIDR)	21,9 %	7,1 %	7,0 %	7,0 %	6,3 %	
(RBER, SID=2 and (BFI or UFI)=0)	0,02 %	0,01 %	0,01 %	0,01 %	0,01 %	
(ESIDR)	17,1 %	3,6 %	3,6 %	3,6 %	3,4 %	
(RBER, SID=1 or SID=2)	0,5 %	0,27 %	0,26 %	0,26 %	0,20 %	
TCH/AFS12.2 (FER)	22 %	3,5 %	6 %	3,5 %	2,5 %	
Class Ib (RBER)	0,9 %	1,7 %	1,7 %	1,7 %	1,5 %	
TCH/AFS10.2 (FER)	18 %	1,4 %	2,7 %	1,4 %	0,92 %	
Class Ib (RBER)	0,53 %	0,22 %	0,3 %	0,21 %	0,16 %	
TCH/AFS7.95 (FER)	13 %	0,13 %	0,51 %	0,12 %	0,073 %	
Class Ib (RBER)	0,66 %	0,071 %	0,15 %	0,065 %	0,044 %	
(FER@-3dB)	26 %	2,7 %	5,3 %	2,7 %	1,8 %	
Class Ib (RBER@-3dB)	1,2 %	0,79 %	1 %	0,78 %	0,6 %	
TCH/AFS7.4 (FER)	14 %	0,16 %	0,56 %	0,16 %	0,09 %	
Class Ib (RBER)	0,43 %	0,032 %	0,072 %	0,032 %	0,018 %	
(FER@-3dB)	26 %	3 %	5,4 %	3,1 %	2 %	
Class Ib (RBER@-3dB)	0,79 %	0,38 %	0,52 %	0,38 %	0,28 %	
TCH/AFS6.7 (FER)	11 %	0,045 %	0,21 %	0,041 %	0,021 %	
Class Ib (RBER)	0,75 %	0,044 %	0,11 %	0,042 %	0,028 %	
(FER@-3dB)	23 %	1,2 %	2,9 %	1,2 %	0,75 %	
Class Ib (RBER@-3dB)	1,4 %	0,6 %	0,86 %	0,6 %	0,44 %	
TCH/AFS5.9 (FER)	10 %	0,018 %	0,12 %	0,018 %	< 0,01 % ^(*)	
Class Ib (RBER)	0,38 %	0,005 %	0,022 %	0,005 %	0,003 %	
(FER@-3dB)	21 %	0,71 %	2 %	0,7 %	0,4 %	
Class Ib (RBER@-3dB)	0,74 %	0,11 %	0,23 %	0,12 %	0,079 %	

(continued)

Table 2 (continued): Reference interference performance for GMSK modulated signals

Type of Channel		GSM 850 and GSM 900				
		Propagation conditions				
		TU3 (no FH)	TU3 (ideal FH)	TU50 (no FH)	TU50 (ideal FH)	RA250 (no FH)
TCH/AFS5.15	(FER)	9,2 %	0,011 %	0,081 %	0,011 %	< 0,01 % ^(*)
	Class Ib (RBER)	0,44 %	0,004 %	0,019 %	0,003 %	0,002 %
	(FER@-3dB)	19 %	0,45 %	1,4 %	0,47 %	0,25 %
	Class Ib (RBER@-3dB)	0,85 %	0,1 %	0,22 %	0,11 %	0,069 %
TCH/AFS4.75	(FER)	7,9 %	< 0,01 % ^(*)	0,036 %	< 0,01 % ^(*)	< 0,01 % ^(*)
	Class Ib (RBER)	0,32 %	0,001 %	0,006 %	0,001 %	< 0,001 %
	(FER@-3dB)	17 %	0,21 %	0,82 %	0,23 %	0,11 %
	Class Ib (RBER@-3dB)	0,62 %	0,036 %	0,11 %	0,033 %	0,019 %
TCH/AFS-INB	(FER)	1,5 %	0,019 %	0,025 %	0,018 %	0,009 %
	(FER@-3dB)	3,5 %	0,15 %	0,22 %	0,16 %	0,1 %
TCH/AFS	(EVSIDUR)	11 %	0,37 %	1,4 %	0,39 %	0,46 %
	(EVSIDUR@-3dB)	21 %	3,4 %	6,3 %	3,4 %	3,1 %
TCH/AFS	(EVRFR)	10 %	0,026 %	0,15 %	0,024 %	0,01 %
	(EVRFR @ -3dB)	21 %	0,77 %	2,08 %	0,77 %	0,48 %
TCH/AHS7.95	(FER)	27 %	23 %	22 %	22 %	21 %
	Class Ib (RBER)	0,84 %	2,2 %	2,3 %	2,3 %	2,1 %
	Class II (RBER)	1,7 %	5,1 %	5,3 %	5,3 %	5 %
	(FER@+3dB)	14 %	7 %	6,7 %	6,7 %	7 %
	Class Ib (RBER@+3dB)	0,48 %	1 %	1 %	1 %	1 %
	Class II (RBER@+3dB)	1 %	3,2 %	3,2 %	3,2 %	3,2 %
TCH/AHS7.4	(FER)	25 %	19 %	18 %	18 %	17 %
	Class Ib (RBER)	0,68 %	1,4 %	1,4 %	1,4 %	1,3 %
	Class II (RBER)	1,9 %	5,4 %	5,6 %	5,6 %	5,4 %
	(FER@+3dB)	13 %	5,2 %	4,8 %	4,8 %	5,3 %
	Class Ib (RBER@+3dB)	0,38 %	0,52 %	0,51 %	0,51 %	0,5 %
	Class II (RBER@+3dB)	1,2 %	3,3 %	3,3 %	3,3 %	3,4 %
TCH/AHS6.7	(FER)	23 %	12 %	11 %	11 %	11 %
	Class Ib (RBER)	0,71 %	1,2 %	1,2 %	1,2 %	1,1 %
	Class II (RBER)	2,3 %	6 %	6,2 %	6,2 %	6 %
	(FER@+3dB)	11 %	2,6 %	2,3 %	2,3 %	2,9 %
	Class Ib (RBER@+3dB)	0,39 %	0,39 %	0,39 %	0,39 %	0,4 %
	Class II (RBER@+3dB)	1,4 %	3,5 %	3,6 %	3,6 %	3,6 %
TCH/AHS5.9	(FER)	21 %	7,9 %	7,1 %	7,1 %	7 %
	Class Ib (RBER)	0,55 %	0,58 %	0,57 %	0,57 %	0,51 %
	Class II (RBER)	2,6 %	6,4 %	6,5 %	6,5 %	6,3 %
TCH/AHS5.15	(FER)	17 %	3,9 %	3,3 %	3,3 %	3,5 %
	Class Ib (RBER)	0,8 %	0,65 %	0,6 %	0,6 %	0,57 %
	Class II (RBER)	3,1 %	6,8 %	6,9 %	6,9 %	6,7 %
TCH/AHS4.75	(FER)	15 %	2,2 %	1,8 %	1,8 %	2,1 %
	Class Ib (RBER)	0,6 %	0,25 %	0,22 %	0,22 %	0,22 %
	Class II (RBER)	3,6 %	6,9 %	7 %	7 %	6,9 %
TCH/AHS-INB	(FER)	2,7 %	0,76 %	0,7 %	0,7 %	0,63 %
	(FER@-3dB)	6 %	2,2 %	2,2 %	2,2 %	2 %
TCH/AHS	(EVSIDUR)	15 %	3,2 %	2,5 %	2,5 %	3,8 %
	(EVSIDUR@-3dB)	28 %	15 %	15 %	15 %	15 %

(continued)

Table 2 (continued): Reference interference performance for GMSK modulated signals

DCS 1 800 & PCS 1 900						
Type of channel		Propagation conditions				
		TU1,5 (no FH)	TU1,5 (ideal FH)	TU50 (no FH)	TU50 (ideal FH)	RA130 (no FH)
FACCH/H	(FER)	22 %	6,7 %	6,9 %	6,9 %	5,7 %
FACCH/F	(FER)	22 %	3,4 %	3,4 %	3,4 %	3,5 %
SDCCH	(FER)	22 %	9 %	9 %	9 %	8 %
RACH	(FER)	15 %	15 %	16 %	16 %	13 %
SCH	(FER)	17 %	17 %	19 %	19 %	18 %
TCH/F14,4	(BER)	10 %	3 %	4 %	3,1 %	3 %
TCH/F9,6 & H4,8	(BER)	8 %	0,3 %	0,8 %	0,3 %	0,2 %
TCH/F4,8	(BER)	3 %	10 ⁻⁴	10 ⁻⁴	10 ⁻⁴	10 ⁻⁴
TCH/F2,4	(BER)	3 %	10 ⁻⁵	10 ⁻⁵	10 ⁻⁵	10 ⁻⁵
TCH/H2,4	(BER)	4 %	10 ⁻⁴	10 ⁻⁴	10 ⁻⁴	10 ⁻⁴
TCH/FS	(FER)	21 α %	3 α %	3 α %	3 α %	3 α %
	class Ib (RBER)	2/ α %	0,2/ α %	0,25/ α %	0,25/ α %	0,2/ α %
	class II (RBER)	4 %	8 %	8,1 %	8,1 %	8 %
TCH/EFS	(FER)	23 %	3 %	3 %	3 %	4 %
	(RBER Ib)	0,20 %	0,10 %	0,10 %	0,10 %	0,13 %
	(RBER II)	3 %	8 %	8 %	8 %	8 %
TCH/HS	(FER)	19,1 %	5,0 %	5,0 %	5,0 %	4,7 %
	class Ib (RBER, BFI=0)	0,52 %	0,27 %	0,29 %	0,29 %	0,21 %
	class II (RBER, BFI=0)	2,8 %	7,1 %	7,2 %	7,2 %	7,0 %
	(UFR)	20,7 %	6,2 %	6,1 %	6,1 %	5,6 %
	class Ib (RBER, (BFI or UFI)=0)	0,29 %	0,20 %	0,21 %	0,21 %	0,17 %
	(EVSIDR)	21,9 %	7,1 %	7,0 %	7,0 %	6,3 %
	(RBER, SID=2 and (BFI or UFI)=0)	0,02 %	0,01 %	0,01 %	0,01 %	0,01 %
	(ESIDR)	17,1 %	3,6 %	3,6 %	3,6 %	3,4 %
	(RBER, SID=1 or SID=2)	0,5 %	0,27 %	0,26 %	0,26 %	0,20 %
TCH/AFS12.2	(FER)	22 %	3,5 %	2,7 %	2,7 %	1,8 %
	Class Ib (RBER)	0,92 %	1,7 %	1,6 %	1,6 %	1,4 %
TCH/AFS10.2	(FER)	18 %	1,4 %	0,98 %	0,98 %	0,56 %
	Class Ib (RBER)	0,54 %	0,21 %	0,17 %	0,17 %	0,12 %
TCH/AFS7.95	(FER)	13 %	0,13 %	0,07 %	0,07 %	0,029 %
	Class Ib (RBER)	0,67 %	0,068 %	0,042 %	0,042 %	0,03 %
	(FER@-3dB)	25 %	2,7 %	2 %	2 %	1,2 %
	Class Ib	1,2 %	0,8 %	0,68 %	0,68 %	0,48 %
	(RBER@-3dB)					
TCH/AFS7.4	(FER)	14 %	0,17 %	0,083 %	0,083 %	0,047 %
	Class Ib (RBER)	0,43 %	0,032 %	0,02 %	0,02 %	0,012 %
	(FER@-3dB)	26 %	3 %	2,3 %	2,3 %	1,4 %
	Class Ib	0,8 %	0,38 %	0,32 %	0,32 %	0,22 %
	(RBER@-3dB)					
TCH/AFS6.7	(FER)	11 %	0,051 %	0,025 %	0,025 %	< 0,01 % ^(*)
	Class Ib (RBER)	0,76 %	0,047 %	0,028 %	0,028 %	0,016 %
	(FER@-3dB)	22 %	1,2 %	0,82 %	0,82 %	0,41 %
	Class Ib	1,4 %	0,61 %	0,51 %	0,51 %	0,34 %
	(RBER@-3dB)					
TCH/AFS5.9	(FER)	10 %	0,018 %	< 0,01 % ^(*)	< 0,01 % ^(*)	< 0,01 % ^(*)
	Class Ib (RBER)	0,38 %	0,005 %	0,002 %	0,002 %	0,001 %
	(FER@-3dB)	21 %	0,68 %	0,41 %	0,41 %	0,2 %
	Class Ib	0,72 %	0,12 %	0,079 %	0,079 %	0,046 %
	(RBER@-3dB)					

(continued)

Table 2 (continued): Reference interference performance for GMSK modulated signals

DCS 1 800 & PCS 1 900						
Type of channel	Propagation conditions					
	TU1,5 (no FH)	TU1,5 (ideal FH)	TU50 (no FH)	TU50 (ideal FH)	RA130 (no FH)	
TCH/AFS5.15	(FER)	9,2 %	0,013 %	< 0,01 % ^(*)	< 0,01 % ^(*)	< 0,01 % ^(*)
	Class Ib (RBER)	0,45 %	0,004 %	0,001 %	0,001 %	< 0,001 %
	(FER@-3dB)	19 %	0,45 %	0,26 %	0,26 %	0,13 %
TCH/AFS4.75	Class Ib (RBER@-3dB)	0,84 %	0,11 %	0,072 %	0,072 %	0,038 %
	(FER)	7,9 %	< 0,01 % ^(*)	< 0,01 % ^(*)	< 0,01 % ^(*)	-
	Class Ib (RBER)	0,31 %	< 0,001 %	< 0,001 %	< 0,001 %	< 0,001 %
TCH/AFS-INB	(FER@-3dB)	17 %	0,2 %	0,1 %	0,1 %	0,051 %
	Class Ib (RBER@-3dB)	0,61 %	0,033 %	0,021 %	0,021 %	0,009 %
	(FER)	1,5 %	0,016 %	0,013 %	0,013 %	0,008 %
TCH/AFS	(FER@-3dB)	3,5 %	0,16 %	0,12 %	0,12 %	0,1 %
	(EVSIDUR)	11 %	0,41 %	0,3 %	0,3 %	0,36 %
TCH/AFS	(EVSIDUR@-3dB)	21 %	3,5 %	2,8 %	2,8 %	2,8 %
	(EVRFR)	10 %	0,028 %	0,022 %	0,022 %	0,005 %
TCH/AHS7.95	(EVRFR @ -3dB)	21	0,73 %	0,78 %	0,78 %	0,28 %
	(FER)	27 %	23 %	23 %	23 %	20 %
	Class Ib (RBER)	0,85 %	2,2 %	2,3 %	2,3 %	2,1 %
TCH/AHS7.4	Class II (RBER)	1,7 %	5,1 %	5,1 %	5,1 %	5,1 %
	(FER@+3dB)	14 %	7 %	6,7 %	6,7 %	6,5 %
	Class Ib (RBER@+3dB)	0,49 %	1 %	1 %	1 %	0,98 %
TCH/AHS6.7	Class II (RBER@+3dB)	1 %	3,1 %	3,1 %	3,1 %	3,1 %
	(FER)	26 %	18 %	18 %	18 %	16 %
	Class Ib (RBER)	0,69 %	1,4 %	1,4 %	1,4 %	1,3 %
TCH/AHS5.9	Class II (RBER)	1,9 %	5,4 %	5,5 %	5,5 %	5,4 %
	(FER@+3dB)	13 %	5,2 %	4,9 %	4,9 %	4,8 %
	Class Ib (RBER@+3dB)	0,39 %	0,51 %	0,51 %	0,51 %	0,47 %
TCH/AHS5.15	Class II (RBER@+3dB)	1,2 %	3,3 %	3,3 %	3,3 %	3,3 %
	(FER)	23 %	12 %	12 %	12 %	9,9 %
	Class Ib (RBER)	0,71 %	1,2 %	1,2 %	1,2 %	1 %
TCH/AHS4.75	Class II (RBER)	2,3 %	6 %	6 %	6 %	6 %
	(FER@+3dB)	11 %	2,7 %	2,5 %	2,5 %	2,5 %
	Class Ib (RBER@+3dB)	0,39 %	0,39 %	0,38 %	0,38 %	0,37 %
TCH/AHS5.9	Class II (RBER@+3dB)	1,4 %	3,5 %	3,5 %	3,5 %	3,5 %
	(FER)	21 %	7,8 %	7,7 %	7,7 %	6,4 %
	Class Ib (RBER)	0,55 %	0,59 %	0,6 %	0,6 %	0,48 %
TCH/AHS4.75	Class II (RBER)	2,6 %	6,3 %	6,4 %	6,4 %	6,3 %
	(FER)	17 %	3,8 %	3,8 %	3,8 %	3,1 %
	Class Ib (RBER)	0,8 %	0,65 %	0,66 %	0,66 %	0,53 %
TCH/AHS-INB	Class II (RBER)	3,1 %	6,7 %	6,8 %	6,8 %	6,6 %
	(FER)	15 %	2,2 %	2,1 %	2,1 %	1,8 %
	Class Ib (RBER)	0,6 %	0,25 %	0,25 %	0,25 %	0,19 %
TCH/AHS	Class II (RBER)	3,6 %	6,9 %	7 %	7 %	6,8 %
	(FER)	2,8 %	0,76 %	0,71 %	0,71 %	0,6 %
	(FER@-3dB)	5,9 %	2,2 %	2,2 %	2,2 %	1,8 %
TCH/AHS	(EVSIDUR)	15 %	3,1 %	3,1 %	3,1 %	3,5 %
	(EVSIDUR@-3dB)	28 %	15 %	15 %	15 %	14 %
TCH/AHS	(EVRFR)	11 %	0,55 %	0,53 %	0,53 %	0,52 %
	(EVRFR @ -3dB)	22 %	4,3 %	4,5 %	4,5 %	3,8 %

- NOTE 1: The specification for SDCCH applies also for BCCH, AGCH, PCH, SACCH. The actual performance of SACCH, particularly for the C/I TU3 (no FH) and TU 1.5 (no FH) cases should be better.
- NOTE 2: Definitions:
 FER: Frame erasure rate (frames marked with BFI=1)
 FER@-3dB: Frame erasure rate for an interference ratio 3 dB below the reference interference ratio
 FER@+3dB: Frame erasure rate for an interference ratio 3 dB above the reference interference ratio
 UFR: Unreliable frame rate (frames marked with (BFI or UFI)=1)
 EVSIDR: Erased Valid SID frame rate (frames marked with (SID=0) or (SID=1) or ((BFI or UFI)=1) if a valid SID frame was transmitted)
 EVSIDUR: Erased Valid SID_UPDATE frame rate associated to an adaptive speech traffic channel
 EVSIDUR@-3dB: Erased Valid SID_UPDATE frame rate associated to an adaptive speech traffic channel for an interference ratio 3 dB below the reference interference ratio
 ESIDR: Erased SID frame rate (frames marked with SID=0 if a valid SID frame was transmitted)
 EVRFR: Erased Valid RATSCCH frame rate associated to an adaptive speech traffic channel. This relates to the erasure of the RATSCCH message due to the failure to detect the RATSCCH identifier or due to a CRC failure.
 EVRFR@-3dB: Erased Valid RATSCCH frame rate associated to an adaptive speech traffic channel for an interference ratio 3 dB below the reference interference ratio.
 BER: Bit error rate
 RBER, BFI=0: Residual bit error rate (defined as the ratio of the number of errors detected over the frames defined as "good" to the number of transmitted bits in the "good" frames).
 RBER@-3dB: Residual bit error rate for an interference ratio 3 dB below the reference interference ratio
 RBER@+3dB: Residual bit error rate for an interference ratio 3 dB above the reference interference ratio
 RBER, (BFI or UFI)=0: Residual bit error rate (defined as the ratio of the number of errors detected over the frames defined as "reliable" to the number of transmitted bits in the "reliable" frames).
 RBER, SID=2 and (BFI or UFI)=0: Residual bit error rate of those bits in class I which do not belong to the SID codeword (defined as the ratio of the number of errors detected over the frames that are defined as "valid SID frames" to the number of transmitted bits in these frames, under the condition that a valid SID frame was sent).
 RBER, SID=1 or SID=2: Residual bit error rate of those bits in class I which do not belong to the SID codeword (defined as the ratio of the number of errors detected over the frames that are defined as "valid SID frames" or as "invalid SID frames" to the number of transmitted bits in these frames, under the condition that a valid SID frame was sent).
 TCH/AxS-INB FER: The frame error rate for the in-band channel. Valid for both Mode Indication and Mode Command/Mode Request. When testing all four code words shall be used an equal amount of time and the mode of both in-band channels (Mode Indication and Mode Command/Mode Request) shall be changed to a neighbouring mode not more often than every 22 speech frames (440 ms).
- NOTE 3: $1 \leq \alpha \leq 1.6$. The value of α can be different for each channel condition but must remain the same for FER and class Ib RBER measurements for the same channel condition.
- NOTE 4: FER for CCHs takes into account frames which are signalled as being erroneous (by the FIRE code, parity bits, or other means) or where the stealing flags are wrongly interpreted.
- NOTE 5: Ideal FH case assumes perfect decorrelation between bursts. This case may only be tested if such a decorrelation is ensured in the test. For TU50 (ideal FH), sufficient decorrelation may be achieved with 4 frequencies spaced over 5 MHz. The TU3 (ideal FH) and TU1.5 (ideal FH), sufficient decorrelation cannot easily be achieved. These performance requirements are given for information purposes and need not be tested.
- NOTE 6: For AMR, the complete conformance should not be restricted to the channels identified with (*).

Table 2a: Interference ratio at reference performance for GMSK modulated signals

GSM 900 and GSM 850						
Type of channel		Propagation conditions				
		TU3 (no FH)	TU3 (ideal FH)	TU50 (no FH)	TU50 (ideal FH)	RA250 (no FH)
PDTCH/CS-1	dB	13	9	10	9	9
PDTCH/CS-2	dB	15	13	14	13	13
PDTCH/CS-3	dB	16	15	16	15	16
PDTCH/CS-4	dB	21	23	24	24	*
USF/CS-1	dB	19	10	12	10	10
USF/CS-2 to 4	dB	18	9	10	9	8
PRACH/11 bits ¹⁾	dB	8	8	8	8	10
PRACH/8 bits ¹⁾	dB	8	8	8	8	9
GSM 850, MXM 850 and GSM 900						
Type of channel		Propagation conditions				
		TU3 (no FH)	TU3 (ideal FH)	TU50 (no FH)	TU50 (ideal FH)	RA250 (no FH)
PDTCH/MCS-0 ⁵⁾	dB	10	8.5	9	8.5	9
PDTCH/MCS-1	dB	13	9.5	10.5	9.5	10
PDTCH/MCS-2	dB	15	12	12.5	12	12
PDTCH/MCS-3	dB	16.5	16.5	17	17	19
PDTCH/MCS-4	dB	19	21.5	22	22	*
USF/MCS-1 to 4	dB	18	10	11	9.5	9.5
PRACH/11 bits ^{2), 3)}	dB	8	8	8	8	10
PRACH/8 bits ¹⁾	dB	8	8	8	8	9
DCS 1 800 & PCS 1 900						
Type of channel		Propagation conditions				
		TU1,5 (no FH)	TU1,5 (ideal FH)	TU50 (no FH)	TU50 (ideal FH)	RA130 (no FH)
PDTCH/CS-1	dB	13	9	9	9	9
PDTCH/CS-2	dB	15	13	13	13	13
PDTCH/CS-3	dB	16	15	16	16	16
PDTCH/CS-4	dB	21	23	27	27	*
USF/CS-1	dB	19	10	10	10	10
USF/CS-2 to 4	dB	18	9	9	9	7
PRACH/11 bits ¹⁾	dB	9	9	9	9	10
PRACH/8 bits ¹⁾	dB	8	8	8	8	9
DCS 1800, PCS 1 900 and MXM 1900						
Type of channel		Propagation conditions				
		TU1,5 (no FH)	TU1,5 (ideal FH)	TU50 (no FH)	TU50 (ideal FH)	RA130 (no FH)
PDTCH/MCS-0 ⁵⁾	dB	10	8.5	9	8.5	9
PDTCH/MCS-1	dB	13	9.5	10	9.5	10
PDTCH/MCS-2	dB	15	12	12	12	12
PDTCH/MCS-3	dB	16.5	16.5	17	18	19
PDTCH/MCS-4	dB	19	21.5	23	23	*
USF/MCS-1 to 4	dB	18	10	9.5	9.5	9.5
PRACH/11 bits ^{2), 3)}	dB	9	9	9	9	10
PRACH/8 bits ¹⁾	dB	8	8	8	8	9

Performance is specified at 30% BLER for those cases identified with mark **.

NOTE 1: The specification for PDTCH/CS-1 applies also for PACCH, PBCCH, PAGCH, PPCH, PTCCH/D.

NOTE 2: Ideal FH case assumes perfect decorrelation between bursts. This case may only be tested if such a decorrelation is ensured in the test. For TU50 (ideal FH), sufficient decorrelation may be achieved with 4 frequencies spaced over 5 MHz. The TU3 (ideal FH) and TU1.5 (ideal FH), sufficient decorrelation cannot easily be achieved. These performance requirements are given for information purposes and need not be tested.

NOTE 3: PDTCH/CS-4 and PDTCH/MCS-x cannot meet the reference performance for some propagation conditions (*).

NOTE 4: Identification of the correct Training sequence is required. Cases identified by ¹⁾ include one training sequence and cases identified by ²⁾ include 3 training sequences according to 3GPP TS 45.002. The specification

identified by ³⁾ also applies to CPRACH.

NOTE 5: The specification of MCS-0 only applies in DL RTTI configuration.

Table 2b: Cochannel interference ratio (for normal BTS) at reference performance for 8-PSK modulated signals (convolutional coding)

GSM 900, GSM 850 and MXM 850						
Type of channel		Propagation conditions				
		TU3 (no FH)	TU3 (ideal FH)	TU50 (no FH)	TU50 (ideal FH)	RA250 (no FH)
PDTCH/MCS-5	dB	18	14.5	15.5	14.5	16
PDTCH/MCS-6	dB	20	17	18	17.5	21
PDTCH/MCS-7	dB	23.5	23.5	24	24.5	26.5**
PDTCH/MCS-8	dB	28.5	29	30	30	*
PDTCH/MCS-9	dB	30	32	33	35	*
DCS 1 800. PCS 1900 and MXM 1900						
Type of channel		Propagation conditions				
		TU1,5 (no FH)	TU1,5 (ideal FH)	TU50 (no FH)	TU50 (ideal FH)	RA130 (no FH)
PDTCH/MCS-5	dB	18	14.5	15	15	16
PDTCH/MCS-6	dB	20	17	17.5	18	21
PDTCH/MCS-7	dB	23.5	23.5	26	26.5	27**
PDTCH/MCS-8	dB	28.5	29	25**	24.5**	*
PDTCH/MCS-9	dB	30	32	29**	29**	*

Performance is specified at 30% BLER for those cases identified with mark **.

NOTE 1: Ideal FH case assumes perfect decorrelation between bursts. This case may only be tested if such a decorrelation is ensured in the test. For TU50 (ideal FH), sufficient decorrelation may be achieved with 4 frequencies spaced over 5 MHz. The TU3 (ideal FH) and TU1.5 (ideal FH), sufficient decorrelation cannot easily be achieved. These performance requirements are given for information purposes and need not be tested.

NOTE 2: PDTCH for MCS-x can not meet the reference performance for some propagation conditions (*).

Table 2c: Cochannel interference ratio (for MS) at reference performance for 8-PSK modulated signals (convolutional coding)

GSM 850 and GSM 900						
Type of channel		Propagation conditions				
		TU3 (no FH)	TU3 (ideal FH)	TU50 (no FH)	TU50 (ideal FH)	RA250 (no FH)
PDTCH/MCS-5	dB	19,5	14,5	15,5	14,5	16,5
PDTCH/MCS-6	dB	21,5	17	18	17,5	21
PDTCH/MCS-7	dB	26,5	23,5	25	24,5	*
PDTCH/MCS-8	dB	30,5	23,5**	25,5**	25,5**	*
PDTCH/MCS-9	dB	25,5**	28**	30,5**	30,5**	*
USF/MCS-5 to 9	dB	17	10,5	11,5	9	9
DCS 1 800 and PCS 1900						
Type of channel		Propagation conditions				
		TU1,5 (no FH)	TU1,5 (ideal FH)	TU50 (no FH)	TU50 (ideal FH)	RA130 (no FH)
PDTCH/MCS-5	dB	19,5	14,5	15	15,5	16,5
PDTCH/MCS-6	dB	21,5	17	18	18,5	21
PDTCH/MCS-7	dB	26,5	23,5	27,5	28	*
PDTCH/MCS-8	dB	30,5	23,5**	29,5**	29**	*
PDTCH/MCS-9	dB	25,5**	28**	*	*	*
USF/MCS-5 to 9	dB	17	10,5	10	9	9

Performance is specified at 30% BLER for those cases identified with mark **.

NOTE 1: Ideal FH case assumes perfect decorrelation between bursts. This case may only be tested if such a decorrelation is ensured in the test. For TU50 (ideal FH), sufficient decorrelation may be achieved with 4 frequencies spaced over 5 MHz.

NOTE 2: PDTCH for MCS-x can not meet the reference performance for some propagation conditions (*).

Table 2d: Cochannel interference ratio (for normal BTS) at reference performance for ECSD (GMSK and 8-PSK modulated signals)

GSM 900 and GSM 850						
Type of Channel		Propagation conditions				
		TU3 (no FH)	TU3 (ideal FH)	TU50 (no FH)	TU50 (ideal FH)	RA250 (no FH)
E-FACCH/F	dB	17.5	11.5	12.5	11.5	11.5
E-TCH/F28.8 T	dB	27	15	17.5	15.5	16
E-TCH/F 32 T	dB	25.5	15.5	17	15.5	15.5
E-TCH/F28.8 NT	dB	20	13.5	14.5	13.5	13.5
E-TCH/F43.2 NT	dB	24	18.5	19.5	19	21.5
DCS 1 800 & PCS 1900						
Type of Channel		Propagation conditions				
		TU1,5 (no FH)	TU1,5 (ideal FH)	TU50 (no FH)	TU50 ideal FH)	RA130 (no FH)
E-FACCH/F	dB	17.5	11.5	11.5	11.5	11.5
E-TCH/F28.8 T	dB	27	15.5	16	16	17
E-TCH/F 32 T	dB	25.5	15.5	16	15.5	15.5
E-TCH/F28.8 NT	dB	20	13.5	14	14	14.5
E-TCH/F43.2 NT	dB	24	18.5	19.5	19.5	22
NOTE: Ideal FH case assumes perfect decorrelation between bursts. This case may only be tested if such a decorrelation is ensured in the test. For TU50 (ideal FH), sufficient decorrelation may be achieved with 4 frequencies spaced over 5 MHz. The TU3 (ideal FH) and TU1.5 (ideal FH), sufficient decorrelation cannot easily be achieved. These performance requirements are given for information purposes and need not be tested.						

Table 2e: Cochannel interference ratio (for MS) at reference performance for ECSD (GMSK and 8-PSK modulated signals)

GSM 850 and GSM 900						
Type of Channel		Propagation conditions				
		TU3 (no FH)	TU3 (ideal FH)	TU50 (no FH)	TU50 (ideal FH)	RA250 (no FH)
E-FACCH/F	dB	17.5	11.5	12.5	11.5	11.5
E-TCH/F28.8 T	dB	28	15.5	18	16	16
E-TCH/F 32 T	dB	27.5	16	18	16	17.5
E-TCH/F28.8 NT	dB	20.5	14	15	14	14
E-TCH/F43.2 NT	dB	25	19	20	19.5	22
DCS 1 800 & PCS 1900						
Type of Channel		Propagation conditions				
		TU1,5 (no FH)	TU1,5 (ideal FH)	TU50 (no FH)	TU50 ideal FH)	RA130 (no FH)
E-FACCH/F	dB	17.5	11.5	11.5	11.5	11.5
E-TCH/F28.8 T	dB	28	15.5	16	16	17
E-TCH/F 32 T	dB	27.5	16	16.5	16.5	17.5
E-TCH/F28.8 NT	dB	20	13.5	14	14	14.5
E-TCH/F43.2 NT	dB	25	18.5	19.5	19.5	22
NOTE: Ideal FH case assumes perfect decorrelation between bursts. This case may only be tested if such a decorrelation is ensured in the test. For TU50 (ideal FH), sufficient decorrelation may be achieved with 4 frequencies spaced over 5 MHz. The TU3 (ideal FH) and TU1.5 (ideal FH), sufficient decorrelation cannot easily be achieved. These performance requirements are given for information purposes and need not be tested.						

Table 2f: Adjacent channel interference ratio (for normal BTS) at reference performance for 8-PSK modulated signals (convolutional coding)

GSM 900, GSM 850 and MXM 850						
Type of channel		Propagation conditions				
		TU3 (no FH)	TU3 (ideal FH)	TU50 (no FH)	TU50 (ideal FH)	RA250 (no FH)
PDTCH/MCS-5	dB	2.5	-2	-2	-2	1
PDTCH/MCS-6	dB	4.5	0.5	1	1	6.5
PDTCH/MCS-7	dB	8	8	8.5	8.5	13.5**
PDTCH/MCS-8	dB	10.5	12	9**	9.5**	*
PDTCH/MCS-9	dB	12	14	13.5**	13.5**	*
DCS 1 800, PCS 1900 and MXM 1900						
Type of channel		Propagation conditions				
		TU1,5 (no FH)	TU1,5 (ideal FH)	TU50 (no FH)	TU50 (ideal FH)	RA130 (no FH)
PDTCH/MCS-5	dB	2.5	-2	-2	-1.5	1
PDTCH/MCS-6	dB	4.5	0.5	1.5	1.5	6.5
PDTCH/MCS-7	dB	8	8	10.5	11	13.5**
PDTCH/MCS-8	dB	10.5	12	10**	9.5**	*
PDTCH/MCS-9	dB	12	14	16**	16**	*
NOTE 1: Ideal FH case assumes perfect decorrelation between bursts. This case may only be tested if such a decorrelation is ensured in the test. For TU50 (ideal FH), sufficient decorrelation may be achieved with 4 frequencies spaced over 5 MHz. The TU3 (ideal FH) and TU1.5 (ideal FH), sufficient decorrelation cannot easily be achieved. These performance requirements are given for information purposes and need not be tested.						
NOTE 2: PDTCH for MCS-x can not meet the reference performance for some propagation conditions (*).						

Table 2g: Adjacent channel interference ratio (for MS) at reference performance for 8-PSK modulated signals (convolutional coding)

GSM 850 and GSM 900						
Type of channel		Propagation conditions				
		TU3 (no FH)	TU3 (ideal FH)	TU50 (no FH)	TU50 (ideal FH)	RA250 (no FH)
PDTCH/MCS-5	dB	2.5	-2	-1	-2	1
PDTCH/MCS-6	dB	5.5	0.5	2	1	6.5
PDTCH/MCS-7	dB	10.5	8	10	9	*
PDTCH/MCS-8	dB	15.5	9**	11**	10.5**	*
PDTCH/MCS-9	dB	10**	12.5**	17**	15.5**	*
USF/MCS-5 to 9	dB	-1	-8.5	-8	-9.5	-9
DCS 1 800 and PCS 1900						
Type of channel		Propagation conditions				
		TU1,5 (no FH)	TU1,5 (ideal FH)	TU50 (no FH)	TU50 (ideal FH)	RA130 (no FH)
PDTCH/MCS-5	dB	2.5	-2	-2	-1.5	1
PDTCH/MCS-6	dB	5.5	0.5	1.5	1.5	6.5
PDTCH/MCS-7	dB	10.5	8	12.5	12	*
PDTCH/MCS-8	dB	15.5	9**	16**	15.5**	*
PDTCH/MCS-9	dB	10**	12.5**	*	*	*
USF/MCS-5 to 9	dB	-1	-8.5	-9	-9.5	-9
Performance is specified at 30% BLER for those cases identified with mark **.						
NOTE 1: Ideal FH case assumes perfect decorrelation between bursts. This case may only be tested if such a decorrelation is ensured in the test. For TU50 (ideal FH), sufficient decorrelation may be achieved with 4 frequencies spaced over 5 MHz.						
NOTE 2: PDTCH for MCS-x can not meet the reference performance for some propagation conditions (*).						

Table 2h: Adjacent channel interference (for normal BTS) ratio at reference performance for ECSD (8-PSK modulated signals)

GSM 900 and GSM 850						
Type of Channel		Propagation conditions				
		TU3 (no FH)	TU3 (ideal FH)	TU50 (no FH)	TU50 (ideal FH)	RA250 (no FH)
E-TCH/F28.8 T	dB	10	-1	0.5	-1	2.5
E-TCH/F 32 T	dB	7.5	-4	-2.5	-4	-4
E-TCH/F28.8 NT	dB	3.5	-2.5	-1.5	-2.5	-0.5
E-TCH/F43.2 NT	dB	8	2.5	3.5	2.5	12
DCS 1 800 & PCS 1900						
Type of Channel		Propagation conditions				
		TU1,5 (no FH)	TU1,5 (ideal FH)	TU50 (no FH)	TU50 ideal FH)	RA130 (no FH)
E-TCH/F28.8 T	dB	10	-1	-0.5	-0.5	5
E-TCH/F 32 T	dB	7	-4	-3.5	-3.5	-4
E-TCH/F28.8 NT	dB	3.5	-2.5	-2	-2	0.5
E-TCH/F43.2 NT	dB	8	2.5	4	3.5	14
NOTE: Ideal FH case assumes perfect decorrelation between bursts. This case may only be tested if such a decorrelation is ensured in the test. For TU50 (ideal FH), sufficient decorrelation may be achieved with 4 frequencies spaced over 5 MHz. The TU3 (ideal FH) and TU1.5 (ideal FH), sufficient decorrelation cannot easily be achieved. These performance requirements are given for information purposes and need not be tested.						

Table 2i: Adjacent channel interference (for MS) ratio at reference performance for ECSD (8-PSK modulated signals)

GSM 850 and GSM 900						
Type of Channel		Propagation conditions				
		TU3 (no FH)	TU3 (ideal FH)	TU50 (no FH)	TU50 (ideal FH)	RA250 (no FH)
E-TCH/F28.8 T	dB	12.5	-0.5	1.5	0	4
E-TCH/F 32 T	dB	10	-1.5	0	-1.5	-1.5
E-TCH/F28.8 NT	dB	4.5	-2	-1	-2	1
E-TCH/F43.2 NT	dB	9.5	3.5	4.5	4	12.5
DCS 1 800 & PCS 1900						
Type of Channel		Propagation conditions				
		TU1,5 (no FH)	TU1,5 (ideal FH)	TU50 (no FH)	TU50 ideal FH)	RA130 (no FH)
E-TCH/F28.8 T	dB	12.5	-0.5	0.5	0.5	6.5
E-TCH/F 32 T	dB	10	-1.5	-1	-1	-1.5
E-TCH/F28.8 NT	dB	4.5	-2	-1.5	-1.5	2
E-TCH/F43.2 NT	dB	9.5	3.5	5	5	14
NOTE: Ideal FH case assumes perfect decorrelation between bursts. This case may only be tested if such a decorrelation is ensured in the test. For TU50 (ideal FH), sufficient decorrelation may be achieved with 4 frequencies spaced over 5 MHz. The TU3 (ideal FH) and TU1.5 (ideal FH), sufficient decorrelation cannot easily be achieved. These performance requirements are given for information purposes and need not be tested.						

Table 2j: Reference interference performance for GMSK modulated channels

GSM 850 and GSM 900				
Type of Channel		Propagation conditions		
		TU3 (no FH)	TU50 (no FH)	RA250 (no FH)
TCH/ WFS12.65	(dB)	21,5	14,5	12,5
	Class Ib (RBER)	0,08	0,40	0,63
TCH/ WFS8.85	(dB)	20	11,5	9
	Class Ib (RBER)	0,11	0,42	0,73
TCH/ WFS6.60	(dB)	19	10,5	8
	Class Ib (RBER)	0,09	0,16	0,24

DCS 1 800 & PCS 1 900		
Type of channel		Propagation condition
		TU50 (no FH)
TCH/ WFS12.65	(dB)	13
	Class Ib (RBER)	0,63
TCH/ WFS8.85	(dB)	10
	Class Ib (RBER)	0,64
TCH/ WFS6.60	(dB)	9
	Class Ib (RBER)	0,27

NOTE 1:	<p>Definitions:</p> <p>FER: Frame erasure rate (frames marked with BFI=1)</p> <p>UFR: Unreliable frame rate (frames marked with (BFI or UFI)=1)</p> <p>EVSIDR: Erased Valid SID frame rate (frames marked with (SID=0) or (SID=1) or ((BFI or UFI)=1) if a valid SID frame was transmitted)</p> <p>EVSIDUR: Erased Valid SID_UPDATE frame rate associated to an adaptive speech traffic channel</p> <p>ESIDR: Erased SID frame rate (frames marked with SID=0 if a valid SID frame was transmitted)</p> <p>EVRFR: Erased Valid RATSCCH frame rate associated to an adaptive speech traffic channel This relates to the erasure of the RATSCCH message due to the failure to detect the RATSCCH identifier or due to a CRC failure.</p> <p>BER: Bit error rate</p> <p>RBER, BFI=0: Residual bit error rate (defined as the ratio of the number of errors detected over the frames defined as "good" to the number of transmitted bits in the "good" frames).</p> <p>RBER, (BFI or UFI)=0: Residual bit error rate (defined as the ratio of the number of errors detected over the frames defined as "reliable" to the number of transmitted bits in the "reliable" frames).</p> <p>RBER, SID=2 and (BFI or UFI)=0: Residual bit error rate of those bits in class I which do not belong to the SID codeword (defined as the ratio of the number of errors detected over the frames that are defined as "valid SID frames" to the number of transmitted bits in these frames, under the condition that a valid SID frame was sent).</p> <p>RBER, SID=1 or SID=2: Residual bit error rate of those bits in class I which do not belong to the SID codeword (defined as the ratio of the number of errors detected over the frames that are defined as "valid SID frames" or as "invalid SID frames" to the number of transmitted bits in these frames, under the condition that a valid SID frame was sent).</p> <p>TCH/WxS-INB FER: The frame error rate for the in-band channel. Valid for both Mode Indication and Mode Command/Mode Request. When testing all four code words shall be used an equal amount of time and the mode of both in-band channels (Mode Indication and Mode Command/Mode Request) shall be changed to a neighbouring mode not more often than every 22 speech frames (440 ms).</p>
NOTE 2:	<p>The requirements for the DCS 1800 & PCS 1900 TU1.5 (no FH) propagation condition are the same as for the GSM 850 & GSM 900 TU3 (no FH) propagation condition, the requirements for the GSM 850 & GSM 900 TU3 (ideal FH), DCS 1800 & PCS 1900 TU1.5 (ideal FH), GSM 850 & GSM 900 TU50 (ideal FH) and DCS 1800 & PCS 1900 TU50 (ideal FH) propagation conditions are the same as for the DCS 1800 & PCS 1900 TU50 (no FH) propagation condition, and the requirements for the DCS 1800 & PCS 1900 RA130 (no FH) propagation condition are the same as for the GSM 850 & GSM 900 RA250 (no FH) propagation condition.</p>
NOTE 3:	<p>Ideal FH performance is already tested for the TCH/FS channel, therefore these requirements are given for information purposes and need not be tested.</p>
NOTE 4:	<p>As a minimum the test of performance shall include all propagation conditions for maximum implemented codec rate and the remaining implemented codec rates for one propagation condition only, e.g. TU50 (no FH).</p>
NOTE 5:	<p>The performance requirements for inband signalling, SID_UPDATE and RATSCCH are the same as those given for TCH/AFS in Table 2. It is sufficient to test inband signalling, SID_UPDATE and RATSCCH requirements for only one of the channel types TCH/AFS and TCH/WFS.</p>

Table 2k: Reference co-channel interference performance for 8-PSK modulated signals

GSM 850 and GSM 900					
Type of channel	Propagation conditions				
	TU3 (no FH)	TU3 (ideal FH)	TU50 (no FH)	TU50 (ideal FH)	RA250 (no FH)
O-FACCH/F (dB)	15,5	8	10	8	9
O-FACCH/H (dB)	15,5	9	10	9	9,5
O-TCH/AHS12.2 (dB)	22,5	15,5	16,5	15,5	17
Class 1b (RBER)	0,17	0,33	0,30	0,32	0,26
O-TCH/AHS10.2 (dB)	21,5	15	15,5	14,5	15,5
Class 1b (RBER)	0,09	0,15	0,15	0,16	0,20
O-TCH/AHS7.95 (dB)	20,5	14	14,5	13,5	14,5
Class 1b (RBER)	0,06	0,07	0,06	0,07	0,10
O-TCH/AHS7.4 (dB)	20	13	14	12,5	13,5
Class 1b (RBER)	0,08	0,13	0,12	0,13	0,16
O-TCH/AHS6.7 (dB)	19,5	12,5	13,5	12	13
Class 1b (RBER)	0,09	0,13	0,12	0,14	0,20
O-TCH/AHS5.9 (dB)	19	12	13	12	12,5
Class 1b (RBER)	0,11	0,18	0,16	0,18	0,17
O-TCH/AHS5.15 (dB)	18,5	11,5	12,5	11	12
Class 1b (RBER)	0,06	0,08	0,08	0,09	0,09
O-TCH/AHS4.75 (dB)	18	11	12	10,5	11,5
Class 1b (RBER)	0,08	0,10	0,09	0,10	0,13
O-TCH/AHS-INB (FER)	16,5	10,5	10,5	10,5	12,5
O-TCH/AHS (EVSDUR)	16	10	10,5	9,5	10,5
O-TCH/AHS (EVRFR)	16	10	10,5	9,5	11
O-TCH/WFS23.85 (dBm)	22,5	13,5	16	13,5	13,5
Class 1b (RBER)	0,10	0,24	0,15	0,23	0,28
O-TCH/WFS15.85 (dBm)	20	11	13,5	11	10,5
Class 1b (RBER)	0,26	0,55	0,35	0,60	0,60
O-TCH/WFS12.65 (dBm)	18,5	9,5	11,5	9,5	9,5
Class 1b (RBER)	0,18	0,40	0,31	0,45	0,40
O-TCH/WFS8.85 (dBm)	17	8	10,5	7,5	7,5
Class 1b (RBER)	0,16	0,33	0,22	0,40	0,42
O-TCH/WFS6.60 (dBm)	16	7	9,5	7	6,5
Class 1b (RBER)	0,10	0,15	0,14	0,18	0,23
O-TCH/WFS-INB (dBm)	14,5	6	7	6	6
O-TCH/WFS (EVSDUR)	17,5	9,5	11,5	9,5	9,5
O-TCH/WFS (EVRFR)	16,5	7,5	10	7,5	7,5
O-TCH/WHS12.65 (dBm)	22,5	15,5	17	15,5	17
Class 1b (RBER)	0,16	0,37	0,27	0,36	0,32
O-TCH/ WHS8.85 (dBm)	21	14	15	14	15
Class 1b (RBER)	0,07	0,11	0,11	0,11	0,11
O-TCH/ WHS6.60 (dBm)	19,5	12	13,5	12	13
Class 1b (RBER)	0,09	0,13	0,12	0,13	0,14

DCS 1 800 & PCS 1 900		
Type of channel	Propagation conditions	
	TU50 (no FH)	
O-FACCH/F (dB)		9
O-FACCH/H (dB)		9,5
O-TCH/AHS12.2 (dB)		16,5
Class lb (RBER)		0,30
O-TCH/AHS10.2 (dB)		15,5
Class lb (RBER)		0,13
O-TCH/AHS7.95 (dB)		14,5
Class lb (RBER)		0,07
O-TCH/AHS7.4 (dB)		14
Class lb (RBER)		0,12
O-TCH/AHS6.7 (dB)		13
Class lb (RBER)		0,12
O-TCH/AHS5.9 (dB)		12,5
Class lb (RBER)		0,15
O-TCH/AHS5.15 (dB)		12
Class lb (RBER)		0,08
O-TCH/AHS4.75 (dB)		11,5
Class lb (RBER)		0,10
O-TCH/AHS-INB (FER)		11
O-TCH/AHS (EVSIDUR)		10,5
O-TCH/AHS (EVRFR)		10,5
O-TCH/WFS23.85 (dBm)		14,5
Class lb (RBER)		0,20
O-TCH/WFS15.85 (dBm)		12
Class lb (RBER)		0,44
O-TCH/WFS12.65 (dBm)		10,5
Class lb (RBER)		0,32
O-TCH/WFS8.85 (dBm)		9
Class lb (RBER)		0,28
O-TCH/WFS6.60 (dBm)		8
Class lb (RBER)		0,16
O-TCH/WFS-INB (dBm)		6,5
O-TCH/WFS (EVSIDUR)		11
O-TCH/WFS (EVRFR)		9
O-TCH/WHS12.65 (dBm)		16,5
Class lb (RBER)		0,30
O-TCH/ WHS8.85 (dBm)		14,5
Class lb (RBER)		0,11
O-TCH/ WHS6.60 (dBm)		13
Class lb (RBER)		0,12

- NOTE 1: Definitions:
FER: Frame erasure rate (frames marked with BFI=1)
EVSIDUR: Erased Valid SID_UPDATE frame rate associated to an adaptive speech traffic channel
EVRFR: Erased Valid RATSCCH frame rate associated to an adaptive speech traffic channel. This relates to the erasure of the RATSCCH message due to the failure to detect the RATSCCH identifier or due to a CRC failure.
BER: Bit error rate.
RBER: Residual bit error rate.
O-TCH/AxS-INB and O-TCH/WxS-INB FER: The frame error rate for the in-band channel. Valid for both Mode Indication and Mode Command/Mode Request. When testing all four code words shall be used an equal amount of time and the mode of both in-band channels (Mode Indication and Mode Command/Mode Request) shall be changed to a neighbouring mode not more often than every 22 speech frames (440 ms).
- NOTE 2: FER for CCHs takes into account frames which are signalled as being erroneous (by the FIRE code, parity bits, or other means) or where the stealing flags are wrongly interpreted.
- NOTE 3: Ideal FH case assumes perfect decorrelation between bursts. This case may only be tested if such a decorrelation is ensured in the test. For TU50 (ideal FH), sufficient decorrelation may be achieved with 4 frequencies spaced over 5 MHz.
- NOTE 4: The requirements for the DCS 1800 & PCS 1900 TU1.5 (no FH) propagation condition are the same as for the GSM 850 & GSM 900 TU3 (no FH) propagation condition, the requirements for the DCS 1800 & PCS 1900 TU1.5 (ideal FH) and DCS 1800 & PCS 1900 TU50 (ideal FH) propagation conditions are the same as for the DCS 1800 & PCS 1900 TU50 (no FH) propagation condition, and the requirements for the DCS 1800 & PCS 1900 RA130 (no FH) propagation condition are the same as for the GSM 850 & GSM 900 RA250 (no FH) propagation condition.
- NOTE 5: As a minimum the test of performance shall include all propagation conditions for maximum implemented codec rate and the remaining implemented codec rates for one propagation condition only, e.g. TU50 (no FH).
- NOTE 6: For O-TCH/WHS, the performance requirements for inband signalling, SID_UPDATE and RATSCCH are the same as those of O-TCH/AHS. It is sufficient to test inband signalling, SID_UPDATE and RATSCCH requirements for only one of the channel types O-TCH/AHS and O-TCH/WHS.

Table 2I: Reference adjacent channel interference performance for 8-PSK modulated signals

GSM 850 and GSM 900						
Type of channel	Propagation conditions					
	TU3 (no FH)	TU3 (ideal FH)	TU50 (no FH)	TU50 (ideal FH)	RA250 (no FH)	
O-FACCH/F (dB)	0	-7,5	-7,5	-8	-8,5	
O-FACCH/H (dB)	0,5	-6,5	-5,5	-6,5	-6	
O-TCH/AHS12.2 (dB)	5	-1,5	-1	-2	-0,5	
Class lb (RBER)	0,15	0,30	0,26	0,28	0,33	
O-TCH/AHS10.2 (dB)	4,5	-2,5	-2	-3	-2	
Class lb (RBER)	0,11	0,15	0,14	0,14	0,17	
O-TCH/AHS7.95 (dB)	3	-3,5	-3	-4	-3,5	
Class lb (RBER)	0,07	0,08	0,08	0,07	0,07	
O-TCH/AHS7.4 (dB)	2,5	-4,5	-4	-5	-4,5	
Class lb (RBER)	0,11	0,15	0,15	0,15	0,17	
O-TCH/AHS6.7 (dB)	2	-5,5	-4,5	-6	-5,5	
Class lb (RBER)	0,08	0,16	0,15	0,16	0,13	
O-TCH/AHS5.9 (dB)	1,5	-6	-5,5	-6,5	-6,5	
Class lb (RBER)	0,08	0,22	0,19	0,22	0,17	
O-TCH/AHS5.15 (dB)	1	-7	-6	-7	-7	
Class lb (RBER)	0,05	0,11	0,10	0,08	0,10	
O-TCH/AHS4.75 (dB)	0,5	-7,5	-7	-7,5	-7,5	
Class lb (RBER)	0,06	0,13	0,13	0,11	0,12	
O-TCH/AHS-INB (FER)	-1	-7	-7	-7	-6,5	
O-TCH/AHS (EVSIDUR)	-1,5	-8	-8	-8	-7,5	
O-TCH/AHS (EVRFR)	-1	-8,5	-8	-8,5	-7,5	
O-TCH/WFS23.85 (dBm)	5	-4	-2	-4	-4	
Class lb (RBER)	0,09	0,23	0,17	0,21	0,26	
O-TCH/WFS15.85 (dBm)	2	-7	-5	-7	-7	
Class lb (RBER)	0,30	0,54	0,45	0,50	0,60	
O-TCH/WFS12.65 (dBm)	0,5	-9	-7	-9	-9	
Class lb (RBER)	0,11	0,50	0,35	0,46	0,46	
O-TCH/WFS8.85 (dBm)	-0,5	-10,5	-9	-11	-10,5	
Class lb (RBER)	0,13	0,50	0,35	0,31	0,29	
O-TCH/WFS6.60 (dBm)	-1,5	-12,	-10	-12	-11,5	
Class lb (RBER)	0,09	0,17	0,15	0,17	0,16	
O-TCH/WFS-INB (dBm)	-4	-13	-11,5	-13	-13	
O-TCH/WFS (EVSIDUR)	-0,5	-8,5	-7	-8,5	-8	
O-TCH/WFS (EVRFR)	-1	-11	-9,5	-11	-10,5	
O-TCH/WHS12.65 (dBm)	5	-2	-1	-2	0	
Class lb (RBER)	0,17	0,36	0,30	0,33	0,36	
O-TCH/ WHS8.85 (dBm)	3	-4	-3	-3,5	-3	
Class lb (RBER)	0,09	0,12	0,11	0,12	0,14	
O-TCH/ WHS6.60 (dBm)	2	-6	-5	-6	-5,5	
Class lb (RBER)	0,07	0,16	0,15	0,17	0,13	

(continued)

Table 2I (concluded): Reference adjacent channel interference performance for 8-PSK modulated signals

DCS 1 800 & PCS 1 900		
Type of channel		Propagation conditions
		TU50 (no FH)
O-FACCH/F	(dB)	-6,5
O-FACCH/H	(dB)	-5,5
O-TCH/AHS12.2	(dB)	-1
	Class Ib (RBER)	0,30
O-TCH/AHS10.2	(dB)	-2
	Class Ib (RBER)	0,14
O-TCH/AHS7.95	(dB)	-3
	Class Ib (RBER)	0,08
O-TCH/AHS7.4	(dB)	-4
	Class Ib (RBER)	0,17
O-TCH/AHS6.7	(dB)	-5
	Class Ib (RBER)	0,15
O-TCH/AHS5.9	(dB)	-5,5
	Class Ib (RBER)	0,20
O-TCH/AHS5.15	(dB)	-6,5
	Class Ib (RBER)	0,11
O-TCH/AHS4.75	(dB)	-7
	Class Ib (RBER)	0,14
O-TCH/AHS-INB	(FER)	-6,5
O-TCH/AHS	(EVSIDUR)	-7,5
O-TCH/AHS	(EVRFR)	-8
O-TCH/WFS23.85	(dBm)	-2,5
	Class Ib (RBER)	0,18
O-TCH/WFS15.85	(dBm)	-5,5
	Class Ib (RBER)	0,50
O-TCH/WFS12.65	(dBm)	-7,5
	Class Ib (RBER)	0,36
O-TCH/WFS8.85	(dBm)	-10
	Class Ib (RBER)	0,42
O-TCH/WFS6.60	(dBm)	-11,5
	Class Ib (RBER)	0,20
O-TCH/WFS-INB	(dBm)	-11
O-TCH/WFS	(EVSIDUR)	-8
O-TCH/WFS	(EVRFR)	-10,5
O-TCH/WHS12.65	(dBm)	-1
	Class Ib (RBER)	0,32
O-TCH/ WHS8.85	(dBm)	-3
	Class Ib (RBER)	0,12
O-TCH/ WHS6.60	(dBm)	-5
	Class Ib (RBER)	0,16

<p>NOTE 1: Definitions: FER: Frame erasure rate (frames marked with BFI=1) EVSIDUR: Erased Valid SID_UPDATE frame rate associated to an adaptive speech traffic channel EVRFR: Erased Valid RATSCCH frame rate associated to an adaptive speech traffic channel. This relates to the erasure of the RATSCCH message due to the failure to detect the RATSCCH identifier or due to a CRC failure. BER: Bit error rate. RBER: Residual bit error rate. O-TCH/AxS-INB and O-TCH/WxS-INB FER: The frame error rate for the in-band channel. Valid for both Mode Indication and Mode Command/Mode Request. When testing all four code words shall be used an equal amount of time and the mode of both in-band channels (Mode Indication and Mode Command/Mode Request) shall be changed to a neighbouring mode not more often than every 22 speech frames (440 ms).</p> <p>NOTE 2: FER for CCHs takes into account frames which are signalled as being erroneous (by the FIRE code, parity bits, or other means) or where the stealing flags are wrongly interpreted.</p> <p>NOTE 3: Ideal FH case assumes perfect decorrelation between bursts. This case may only be tested if such a decorrelation is ensured in the test. For TU50 (ideal FH), sufficient decorrelation may be achieved with 4 frequencies spaced over 5 MHz.</p> <p>NOTE 4: The requirements for DCS 1800, PCS 1900 and MXM 1900 on TU50 (ideal FH) propagation conditions are the same as for TU50 (no FH). The requirements for the DCS 1800 & PCS 1900 TU1.5 (no FH) propagation condition are the same as for the GSM 850 & GSM 900 TU3 (no FH) propagation condition, the requirements for the DCS 1800 & PCS 1900 TU1.5 (ideal FH) propagation conditions are the same as for the GSM 850 & GSM 900 TU3 (ideal FH), and the requirements for the DCS 1800 & PCS 1900 RA130 (no FH) propagation condition are the same as for the GSM 850 & GSM 900 RA250 (no FH) propagation condition.</p> <p>NOTE 5: As a minimum the test of performance shall include all propagation conditions for maximum implemented codec rate and the remaining implemented codec rates for one propagation condition only, e.g. TU50 (no FH).</p> <p>NOTE 6: For O-TCH/WHS, the performance requirements for inband signalling, SID_UPDATE and RATSCCH are the same as those of O-TCH/AHS. It is sufficient to test inband signalling, SID_UPDATE and RATSCCH requirements for only one of the channel types O-TCH/AHS and O-TCH/WHS.</p>

Table 2m: Co-channel interference ratio at reference performance for FLO

GSM 900 and GSM 850						
FLO Configuration		Propagation conditions				
		TU3 (no FH)	TU3 (ideal FH)	TU50 (no FH)	TU50 (ideal FH)	RA250 (no FH)
Reference TFC 1	(dB)	15,0	9,0	10,0	9,0	8,5
Reference TFC 2	(dB)	18,0	11,5	12,0	11,5	11,5
Reference TFC 3	(dB)	18,5	9,5	11,0	9,5	9,5
Reference TFC 4	(dB)	22,0	14,5	14,5	14,5	14,0
Reference TFC 5	(dB)	22,0	12,5	14,5	14,0	11,5
Reference TFC 6	(dB)	19,5	15,5	16,5	15,5	15,0
Reference TFC 7	(dB)	24,5	23,0	23,5	23,0	-
DCS 1 800 & PCS 1900						
FLO Configuration		Propagation conditions				
		TU1,5 (no FH)	TU1,5 (ideal FH)	TU50 (no FH)	TU50 ideal FH)	RA130 (no FH)
Reference TFC 1	(dB)	(2)	(2)	9,0	(2)	(2)
Reference TFC 2	(dB)	(2)	(2)	12,0	(2)	(2)
Reference TFC 3	(dB)	(2)	(2)	9,5	(2)	(2)
Reference TFC 4	(dB)	(2)	(2)	14,5	(2)	(2)
Reference TFC 5	(dB)	(2)	(2)	13,0	(2)	(2)
Reference TFC 6	(dB)	(2)	(2)	15,5	(2)	(2)
Reference TFC 7	(dB)	(2)	(2)	25,0	(2)	(2)
NOTE 1: Ideal FH case assumes perfect decorrelation between bursts. This case may only be tested if such a decorrelation is ensured in the test. For TU50 (ideal FH), sufficient decorrelation may be achieved with 4 frequencies spaced over 5 MHz. The TU3 (ideal FH) and TU1.5 (ideal FH), sufficient decorrelation cannot easily be achieved. These performance requirements are given for information purposes and need not be tested.						
NOTE 2: The requirements for the DCS 1800 & PCS 1900 TU1.5 (no FH) propagation condition are the same as for the GSM 850 & GSM 900 TU3 (no FH) propagation condition, the requirements for the DCS 1800 & PCS 1900 TU1.5 (ideal FH), and DCS 1800 & PCS 1900 TU50 (ideal FH) propagation conditions are the same as for the DCS 1800 & PCS 1900 TU50 (no FH) propagation condition, and the requirements for the DCS 1800 & PCS 1900 RA130 (no FH) propagation condition are the same as for the GSM 850 & GSM 900 RA250 (no FH) propagation condition.						

Table 2n: Adjacent channel interference ratio at reference performance for FLO

GSM 900 and GSM 850						
FLO Configuration		Propagation conditions				
		TU3 (no FH)	TU3 (ideal FH)	TU50 (no FH)	TU50 (ideal FH)	RA250 (no FH)
Reference TFC 1	(dB)	(3)	(3)	(3)	(3)	(3)
Reference TFC 2	(dB)	(3)	(3)	(3)	(3)	(3)
Reference TFC 3	(dB)	(3)	(3)	(3)	(3)	(3)
Reference TFC 4	(dB)	5,0	-2,5	-2,5	-2,5	-3,0
Reference TFC 5	(dB)	5,5	-4,5	-3,0	-4,5	-5,0
Reference TFC 6	(dB)	3,0	-1,5	-0,5	-1,5	1,0
Reference TFC 7	(dB)	7,0	6,0	6,5	6,5	-
DCS 1 800 & PCS 1900						
FLO Configuration		Propagation conditions				
		TU1,5 (no FH)	TU1,5 (ideal FH)	TU50 (no FH)	TU50 ideal FH)	RA130 (no FH)
Reference TFC 1	(dB)	(3)	(3)	(3)	(3)	(3)
Reference TFC 2	(dB)	(3)	(3)	(3)	(3)	(3)
Reference TFC 3	(dB)	(3)	(3)	(3)	(3)	(3)
Reference TFC 4	(dB)	(2)	(2)	-2,0	(2)	(2)
Reference TFC 5	(dB)	(2)	(2)	-4,0	(2)	(2)
Reference TFC 6	(dB)	(2)	(2)	-1,0	(2)	(2)
Reference TFC 7	(dB)	(2)	(2)	8,0	(2)	(2)
NOTE 1: Ideal FH case assumes perfect decorrelation between bursts. This case may only be tested if such a decorrelation is ensured in the test. For TU50 (ideal FH), sufficient decorrelation may be achieved with 4 frequencies spaced over 5 MHz. The TU3 (ideal FH) and TU1.5 (ideal FH), sufficient decorrelation cannot easily be achieved. These performance requirements are given for information purposes and need not be tested.						
NOTE 2: The requirements for the DCS 1800 & PCS 1900 TU1.5 (no FH) propagation condition are the same as for the GSM 850 & GSM 900 TU3 (no FH) propagation condition, the requirements for the DCS 1800 & PCS 1900 TU1.5 (ideal FH), and DCS 1800 & PCS 1900 TU50 (ideal FH) propagation conditions are the same as for the DCS 1800 & PCS 1900 TU50 (no FH) propagation condition, and the requirements for the DCS 1800 & PCS 1900 RA130 (no FH) propagation condition are the same as for the GSM 850 & GSM 900 RA250 (no FH) propagation condition.						
NOTE 3: The adjacent channel interference ratio for Reference TFCs 1,2 and 3 shall be 18 dB less than the cochannel interference ratio (see Table 2m).						

Table 2o: C/I1 ratio at reference performance for DARP

GSM 900 and GSM 850						
Propagation condition		TU50 no FH				
Type of channel		DARP Test Scenario				
		DTS-1 ^(note 1)	DTS-2	DTS-3	DTS-4	DTS-5
FACCH/F	(dB)	3	[8	9	-	-
SDCCH	(dB)	4	9,5	10	-	-
TCH/FS	(dB)	4,5	9,5	10	6,5	9,5
	Class Ib	0,10	0,10	0,10	0,10	0,10
	Class II	4,60	4,40	4,30	5,02	4,60
TCH/AFS12.2	(dB)	5	10	10	6,5	10
	Class Ib	0,60	0,60	0,50	0,80	0,70
TCH/AFS10.2	(dB)	3,5	8,5	9	-	-
	Class Ib	0,20	0,15	0,15	-	-
TCH/AFS7.95	(dB)	1,5	6,5	7,5	-	-
	Class Ib	0,35	0,28	0,28	-	-
TCH/AFS7.4	(dB)	1,5	6,5	7,5	-	-
	Class Ib	0,20	0,15	0,15	-	-
TCH/AFS6.7	(dB)	0	5,5	7	-	-
	Class Ib	0,50	0,39	0,37	-	-
TCH/AFS5.9	(dB)	0	5,5	6,5	1	5,5
	Class Ib	0,20	0,20	0,15	0,16	0,20
TCH/AFS5.15	(dB)	-1	5	5,5	-	-
	Class Ib	0,21	0,20	0,25	-	-
TCH/AFS4.75	(dB)	-1,5	4,5	5	-	-
	Class Ib	0,15	0,15	0,15	-	-
TCH/AHS7.95	(dB)	9	14	14,5	-	-
	Class Ib	0,35	0,30	0,35	-	-
	Class II	1,80	1,60	1,43	-	-
TCH/AHS7.4	(dB)	8,5	12,5	13,5	-	-
	Class Ib	0,25	0,20	0,20	-	-
	Class II	2,20	1,90	1,80	-	-
TCH/AHS6.7	(dB)	7	11,5	12	-	-
	Class Ib	0,25	0,30	0,25	-	-
	Class II	2,90	2,80	2,50	-	-
TCH/AHS5.9	(dB)	6	10,5	11,5	-	-
	Class Ib	0,15	0,15	0,15	-	-
	Class II	3,70	3,50	3,50	-	-
TCH/AHS5.15	(dB)	4,5	9	10	-	-
	Class Ib	0,25	0,30	0,30	-	-
	Class II	4,90	4,50	4,80	-	-
TCH/AHS4.75	(dB)	3	7,5	8,5	-	-
	Class Ib	0,20	0,25	0,20	-	-
	Class II	6,50	5,80	5,50	-	-
PDTCH CS-1	(dB)	3	8	8,5	-	-
PDTCH CS-2	(dB)	6	10,5	11	-	-
PDTCH CS-3	(dB)	8,5	13	13,5	-	-
PDTCH CS-4	(dB)	19,5	22	22,5	-	-
PDTCH MCS-1	(dB)	3,5	9,5	10,5	-	-
PDTCH MCS-2	(dB)	5,5	11	12	-	-
PDTCH MCS-3	(dB)	11	15	15,5	-	-
PDTCH MCS-4	(dB)	18	20	21	-	-

(Continued)

Table 2o (continued): C/I1 ratio at reference performance for DARP

DCS 1 800 & PCS 1900						
Propagation condition		TU50 no FH				
Type of channel		DARP Test Scenario				
		DTS-1 ^(note 1)	DTS-2	DTS-3	DTS-4	DTS-5
FACCH/F	(dB)	3	7,5	8	-	-
SDCCH	(dB)	4	8,5	9,5	-	-
TCH/FS	(dB)	3,5	9	9	6	[9
	Class Ib	0,10	0,10	0,10	0,10	0,10
	Class II	5,30	5,70	5,40	6,09	5,80
TCH/AFS12.2	(dB)	4	9	10	6	9
	Class Ib	0,87	0,89	0,80	0,95	1,10
TCH/AFS10.2	(dB)	3	7,5	8,5	-	-
	Class Ib	0,20	0,20	0,20	-	-
TCH/AFS7.95	(dB)	0,5	5,5	6,5	-	-
	Class Ib	0,36	0,43	0,40	-	-
TCH/AFS7.4	(dB)	0,5	5,5	6,5	-	-
	Class Ib	0,20	0,20	0,20	-	-
TCH/AFS6.7	(dB)	-0,5	4,5	5,5	-	-
	Class Ib	0,70	0,60	0,56	-	-
TCH/AFS5.9	(dB)	-1	4,5	5	0	4
	Class Ib	0,20	0,30	0,16	0,21	0,22
TCH/AFS5.15	(dB)	-1,5	3,5	4,5	-	-
	Class Ib	0,25	0,30	0,25	-	-
TCH/AFS4.75	(dB)	-2	3	4	-	-
	Class Ib	0,15	0,20	0,20	-	-
TCH/AHS7.95	(dB)	10	14	15	-	-
	Class Ib	0,35	0,40	0,30	-	-
	Class II	1,70	1,80	1,50	-	-
TCH/AHS7.4	(dB)	9	13	14	-	-
	Class Ib	0,20	0,20	0,20	-	-
	Class II	2,10	1,90	1,90	-	-
TCH/AHS6.7	(dB)	7,5	11,5	12,5	-	-
	Class Ib	0,25	0,25	0,25	-	-
	Class II	3,20	2,80	2,50	-	-
TCH/AHS5.9	(dB)	6	10,5	11,5	-	-
	Class Ib	0,15	0,20	0,20	-	-
	Class II	3,80	3,40	3,30	-	-
TCH/AHS5.15	(dB)	5	9	10	-	-
	Class Ib	0,31	0,30	0,30	-	-
	Class II	5,00	4,70	4,40	-	-
TCH/AHS4.75	(dB)	3,5	8	9	-	-
	Class Ib	0,20	0,25	0,20	-	-
	Class II	6,70	5,90	5,46	-	-
PDTCH CS-1	(dB)	2,5	7	8	-	-
PDTCH CS-2	(dB)	6	10,5	11	-	-
PDTCH CS-3	(dB)	9	12,5	13	-	-
PDTCH CS-4	(dB)	22	23,5	24	-	-
PDTCH MCS-1	(dB)	3,5	9	10	-	-
PDTCH MCS-2	(dB)	6,5	11	11,5	-	-
PDTCH MCS-3	(dB)	11,5	15	15,5	-	-
PDTCH MCS-4	(dB)	19,5	22	22,5	-	-

NOTE 1: DARP Test Scenario 1 (DTS-1) is similar to testing of co-channel interference for non-DARP receivers with essentially at least as stringent requirements under TU50noFH propagation conditions. Thus the non-DARP test under this propagation condition need not be tested for MS indicating support for Downlink Advanced Receiver Performance – phase I (see 3GPP TS 24.008).

Table 2p: Co-channel interference ratio at reference performance for Repeated Downlink FACCH and Repeated SACCH

GSM 900 and GSM 850						
	(dB)	Propagation conditions				RA250 (no FH)
		TU3 (no FH)	TU3 (ideal FH)	TU50 (no FH)	TU50 (ideal FH)	
FACCH/F		11,5	4,5	5,5	4,5	4,5
FACCH/H		[tbd]	[tbd]	[tbd]	[tbd]	[tbd]
SACCH		5,0	4,5	4,5	4,5	4,5
DCS 1 800 & PCS 1900						
	(dB)	Propagation conditions				RA130 (no FH)
		TU1,5 (no FH)	TU1,5 (ideal FH)	TU50 (no FH)	TU50 ideal FH)	
FACCH/F		(2)	(2)	4,5	(2)	(2)
FACCH/H		(2)	(2)	[tbd]	(2)	(2)
SACCH		(2)	(2)	4,5	(2)	(2)
NOTE 1: Ideal FH case assumes perfect decorrelation between bursts. This case may only be tested if such a decorrelation is ensured in the test. For TU50 (ideal FH), sufficient decorrelation may be achieved with 4 frequencies spaced over 5 MHz. The TU3 (ideal FH) and TU1.5 (ideal FH), sufficient decorrelation cannot easily be achieved. These performance requirements are given for information purposes and need not be tested.						
NOTE 2: The requirements for the DCS 1800 & PCS 1900 TU1.5 (no FH) propagation condition are the same as for the GSM 850 & GSM 900 TU3 (no FH) propagation condition, the requirements for the DCS 1800 & PCS 1900 TU1.5 (ideal FH), and DCS 1800 & PCS 1900 TU50 (ideal FH) propagation conditions are the same as for the DCS 1800 & PCS 1900 TU50 (no FH) propagation condition, and the requirements for the DCS 1800 & PCS 1900 RA130 (no FH) propagation condition are the same as for the GSM 850 & GSM 900 RA250 (no FH) propagation condition.						

Table 2q : C/I1 ratio at reference performance for Downlink Advanced Receiver Performance – phase II

GSM 900 and GSM 850				
Propagation conditions				
TU50 (noFH)				
Correlation=0; AGI=0 dB				
		DTS-1/DTS-1b ^{Note1}	DTS-2	DTS-5
TCH/FS	FER (dB)	-12,0	1,0	1,0
	Rber1b	0,06%	0,10%	0,07%
	Rber2	5,37%	4,90%	5,01%
TCH/AFS12.2	FER (dB)	-11,0	2,5	2,5
	Rber1b	0,69%	0,64%	0,67%
TCH/AFS7.4	FER (dB)	-13,5	0,0	0,0
	Rber1b	0,21%	0,15%	0,15%
TCH/AFS5.9	FER (dB)	-15,0	-1,5	-2,0
	Rber1b	0,17%	0,16%	0,23%
TCH/AHS7.4	FER (dB)	-7,5	4,5	4,5
	Rber1b	0,40%	0,50%	0,53%
	Rber2	1,88%	2,25%	2,49%
TCH/AHS5.9	FER (dB)	-9,5	3,0	3,0
	Rber1b	0,51%	0,64%	0,59%
	Rber2	3,27%	3,85%	4,05%
PDTCH CS-1	BLER (dB)	-12,5	0,5	0,5
PDTCH CS-2	BLER (dB)	-9,5	3,0	3,5
PDTCH CS-3	BLER (dB)	-8,0	5,0	5,5
PDTCH CS-4	BLER (dB)	0,0	12,0	13,0
PDTCH MCS-1	BLER (dB)	-11,5	1,0	1,5
PDTCH MCS-2	BLER (dB)	-10,0	2,5	2,5
PDTCH MCS-3	BLER (dB)	-6,5	6,0	6,0
PDTCH MCS-4	BLER (dB)	-1,0	11,0	12,5
PDTCH MCS-5	BLER (dB)	-6,5	7,0	8,0
PDTCH MCS-6	BLER (dB)	-4,0	9,0	10,5
PDTCH MCS-7	BLER (dB)	1,5	13,5	15,0
PDTCH MCS-8	BLER (dB)	1,5**	20,0	20,5
PDTCH MCS-9	BLER (dB)	6,0**	23,5	26,5
PDTCH DAS-5	BLER (dB)	[tbd]	[tbd]	[tbd]
PDTCH DAS-6	BLER (dB)	[tbd]	[tbd]	[tbd]
PDTCH DAS-7	BLER (dB)	[tbd]	[tbd]	[tbd]
PDTCH DAS-8	BLER (dB)	[tbd]	[tbd]	[tbd]
PDTCH DAS-9	BLER (dB)	[tbd]	[tbd]	[tbd]
PDTCH DAS-10	BLER (dB)	[tbd]	[tbd]	[tbd]
PDTCH DAS-11	BLER (dB)	[tbd]	[tbd]	[tbd]
PDTCH DAS-12	BLER (dB)	[tbd]	[tbd]	[tbd]
PDTCH DBS-5	BLER (dB)	[tbd]	[tbd]	[tbd]
PDTCH DBS-6	BLER (dB)	[tbd]	[tbd]	[tbd]
PDTCH DBS-7	BLER (dB)	[tbd]	[tbd]	[tbd]
PDTCH DBS-8	BLER (dB)	[tbd]	[tbd]	[tbd]
PDTCH DBS-9	BLER (dB)	[tbd]	[tbd]	[tbd]
PDTCH DBS-10	BLER (dB)	[tbd]	[tbd]	[tbd]
PDTCH DBS-11	BLER (dB)	[tbd]	[tbd]	[tbd]
PDTCH DBS-12	BLER (dB)	[tbd]	[tbd]	[tbd]

NOTE: Performance is specified at 30% BLER for those cases identified with mark "****"

NOTE: Performance is not specified for those cases identified with mark "-"

NOTE 1: DARP Test Scenario 1 (DTS-1) is similar to testing of co-channel interference for non-DARP receivers with essentially at least as stringent requirements under TU50noFH propagation conditions. DTS-1b utilizes an 8-PSK

modulated interferer and is to be applied for MCS5-MCS9.

Table 2q continued: C/I1 ratio at reference performance for Downlink Advanced Receiver Performance – phase II

DCS 1800 and PCS 1900				
Propagation conditions				
TU50 (noFH)				
Correlation=0; AGI=0 dB				
		DTS-1/DTS-1b ^{Note1}	DTS-2	DTS-5
TCH/FS	FER (dB)	-11,5	0,5	0,5
	Rber1b	0,08%	0,08%	0,09%
	Rber2	5,86%	5,91%	6,01%
TCH/AFS12.2	FER (dB)	-10,5	1,5	1,5
	Rber1b	0,84%	0,94%	0,94%
TCH/AFS7.4	FER (dB)	-13,5	-1,0	-1,0
	Rber1b	0,18%	0,18%	0,19%
TCH/AFS5.9	FER (dB)	-14,5	-2,0	-2,0
	Rber1b	0,20%	0,18%	0,21%
TCH/AHS7.4	FER (dB)	-7,0	4,5	5,0
	Rber1b	0,57%	0,52%	0,56%
	Rber2	2,11%	2,27%	2,34%
TCH/AHS5.9	FER (dB)	-9,0	3,0	3,0
	Rber1b	0,62%	0,70%	0,64%
	Rber2	3,56%	3,75%	3,91%
PDTCH CS-1	BLER (dB)	-12,0	0,0	0,0
PDTCH CS-2	BLER (dB)	-9,0	3,0	3,0
PDTCH CS-3	BLER (dB)	-7,0	4,5	5,0
PDTCH CS-4	BLER (dB)	4,5	12,5	13,5
PDTCH MCS-1	BLER (dB)	-10,5	1,0	1,0
PDTCH MCS-2	BLER (dB)	-8,5	2,5	2,5
PDTCH MCS-3	BLER (dB)	-4,5	6,0	6,0
PDTCH MCS-4	BLER (dB)	2,0	11,5	13,0
PDTCH MCS-5	BLER (dB)	-6,0	6,5	7,5
PDTCH MCS-6	BLER (dB)	-3,5	8,5	9,5
PDTCH MCS-7	BLER (dB)	3,0	14,0	15,0
PDTCH MCS-8	BLER (dB)	5,0**	20,5	22,0
PDTCH MCS-9	BLER (dB)	12,0**	25,0	25,5
PDTCH DAS-5	BLER (dB)	[tbd]	[tbd]	[tbd]
PDTCH DAS-6	BLER (dB)	[tbd]	[tbd]	[tbd]
PDTCH DAS-7	BLER (dB)	[tbd]	[tbd]	[tbd]
PDTCH DAS-8	BLER (dB)	[tbd]	[tbd]	[tbd]
PDTCH DAS-9	BLER (dB)	[tbd]	[tbd]	[tbd]
PDTCH DAS-10	BLER (dB)	[tbd]	[tbd]	[tbd]
PDTCH DAS-11	BLER (dB)	[tbd]	[tbd]	[tbd]
PDTCH DAS-12	BLER (dB)	[tbd]	[tbd]	[tbd]
PDTCH DBS-5	BLER (dB)	[tbd]	[tbd]	[tbd]
PDTCH DBS-6	BLER (dB)	[tbd]	[tbd]	[tbd]
PDTCH DBS-7	BLER (dB)	[tbd]	[tbd]	[tbd]
PDTCH DBS-8	BLER (dB)	[tbd]	[tbd]	[tbd]
PDTCH DBS-9	BLER (dB)	[tbd]	[tbd]	[tbd]
PDTCH DBS-10	BLER (dB)	[tbd]	[tbd]	[tbd]
PDTCH DBS-11	BLER (dB)	[tbd]	[tbd]	[tbd]
PDTCH DBS-12	BLER (dB)	[tbd]	[tbd]	[tbd]

NOTE: Performance is specified at 30% BLER for those cases identified with mark "***"

NOTE: Performance is not specified for those cases identified with mark "-"

NOTE 1: DARP Test Scenario 1 (DTS-1) is similar to testing of co-channel interference for non-DARP receivers with essentially at least as stringent requirements under TU50noFH propagation conditions. DTS-1b utilizes an 8-PSK modulated interferer and is to be applied for MCS5-MCS9.

Table 2r: Cochannel interference ratio (for normal BTS) at reference performance for 16-QAM modulated signals (Normal symbol rate and BTTI) (EGPRS2-A UL)

GSM 900, GSM 850 and MXM 850						
Type of channel		Propagation conditions				
		TU3 (no FH)	TU3 (ideal FH)	TU50 (no FH)	TU50 (ideal FH)	RA250 (no FH)
PDTCH/UAS-7	dB	27	(2)	23,5	22,5	22
PDTCH/UAS-8	dB	28	(2)	25	24,5	25,5
PDTCH/UAS-9	dB	28,5	(2)	27	26,5	33
PDTCH/UAS-10	dB	29,5	(2)	29,5	29,5	34,5**
PDTCH/UAS-11	dB	30,5	(2)	33,0	33,0	-
DCS 1 800. PCS 1900 and MXM 1900						
Type of channel		Propagation conditions				
		TU1,5 (no FH)	TU1,5 (ideal FH)	TU50 (no FH)	TU50 (ideal FH)	RA130 (no FH)
PDTCH/UAS-7	dB	(2)	(2)	23	(2)	(2)
PDTCH/UAS-8	dB	(2)	(2)	25	(2)	(2)
PDTCH/UAS-9	dB	(2)	(2)	26	(2)	(2)
PDTCH/UAS-10	dB	(2)	(2)	26,5**	(2)	(2)
PDTCH/UAS-11	dB	(2)	(2)	29,5**	(2)	(2)
Performance is specified at 30% BLER for those cases identified with mark "**"						
Performance is not specified for those cases identified with mark "-"						
NOTE 1: Ideal FH case assumes perfect decorrelation between bursts. This case may only be tested if such a decorrelation is ensured in the test. For TU50 (ideal FH), sufficient decorrelation may be achieved with 4 frequencies spaced over 5 MHz. The TU3 (ideal FH) and TU1.5 (ideal FH), sufficient decorrelation cannot easily be achieved. These performance requirements are given for information purposes and need not be tested.						
NOTE 2: The requirements for the DCS 1800 & PCS 1900 TU1.5 (no FH) propagation condition are the same as for the GSM 850 & GSM 900 TU3 (no FH) propagation condition, the requirements for the GSM 850 & GSM 900 TU3 (ideal FH), DCS 1800 & PCS 1900 TU1.5 (ideal FH) and DCS 1800 & PCS 1900 TU50 (ideal FH) propagation conditions are the same as for the DCS 1800 & PCS 1900 TU50 (no FH) propagation condition, and the requirements for the DCS 1800 & PCS 1900 RA130 (no FH) propagation condition are the same as for the GSM 850 & GSM 900 RA250 (no FH) propagation condition.						

Table 2s: Cochannel interference ratio (for MS) at reference performance for 8-PSK, 16-QAM and 32-QAM modulated signals (Normal symbol rate, BTTI and turbo-coding) (EGPRS2-A DL)

GSM 850 and GSM 900						
Type of channel		Propagation conditions				
		TU3 (no FH)	TU3 (ideal FH)	TU50 (no FH)	TU50 (ideal FH)	RA250 (no FH)
PDTCH/DAS-5	dB	16,5	(2)	15	15	12,5
PDTCH/DAS-6	dB	18	(2)	16	15,5	14,5
PDTCH/DAS-7	dB	19,5	(2)	17	17	16,5
PDTCH/DAS-8	dB	22,5	(2)	20	19,5	19,5
PDTCH/DAS-9	dB	24,5	(2)	23	23	24,5
PDTCH/DAS-10	dB	28	(2)	26	25,5	24,5**
PDTCH/DAS-11	dB	30,5	(2)	31,5	31	-
PDTCH/DAS-12	dB	34,5	(2)	33**	32,5**	-
USF/DAS-5 to 7	dB	(3)	(3)	(3)	(3)	(3)
USF/DAS-8 to 9	dB	10,0	(2)	6,0	4,5	4,0
USF/DAS-10 to 12	dB	10,0	(2)	7,0	4,5	4,0
DCS 1 800 and PCS 1900						
Type of channel		Propagation conditions				
		TU1,5 (no FH)	TU1,5 (ideal FH)	TU50 (no FH)	TU50 (ideal FH)	RA130 (no FH)
PDTCH/DAS-5	dB	(2)	(2)	15	(2)	(2)
PDTCH/DAS-6	dB	(2)	(2)	16	(2)	(2)
PDTCH/DAS-7	dB	(2)	(2)	17,5	(2)	(2)
PDTCH/DAS-8	dB	(2)	(2)	20	(2)	(2)
PDTCH/DAS-9	dB	(2)	(2)	24	(2)	(2)
PDTCH/DAS-10	dB	(2)	(2)	27	(2)	(2)
PDTCH/DAS-11	dB	(2)	(2)	32**	(2)	(2)
PDTCH/DAS-12	dB	(2)	(2)	-	(2)	(2)
USF/DAS-5 to 7	dB	(3)	(3)	(3)	(3)	(3)
USF/DAS-8 to 9	dB	(2)	(2)	4,5	(2)	(2)
USF/DAS-10 to 12	dB	(2)	(2)	5,5	(2)	(2)
Performance is specified at 30% BLER for those cases identified with mark "**"						
Performance is not specified for those cases identified with mark "-"						
NOTE 1: Ideal FH case assumes perfect decorrelation between bursts. This case may only be tested if such a decorrelation is ensured in the test. For TU50 (ideal FH), sufficient decorrelation may be achieved with 4 frequencies spaced over 5 MHz.						
NOTE 2: The requirements for the DCS 1800 & PCS 1900 TU1.5 (no FH) propagation condition are the same as for the GSM 850 & GSM 900 TU3 (no FH) propagation condition, the requirements for the GSM 850 & GSM 900 TU3 (ideal FH), DCS 1800 & PCS 1900 TU1.5 (ideal FH) and DCS 1800 & PCS 1900 TU50 (ideal FH) propagation conditions are the same as for the DCS 1800 & PCS 1900 TU50 (no FH) propagation condition, and the requirements for the DCS 1800 & PCS 1900 RA130 (no FH) propagation condition are the same as for the GSM 850 & GSM 900 RA250 (no FH) propagation condition.						
NOTE 3: The requirements for USF/DAS-5 to 7 are the same as for USF/MCS-5 to 9.						

Table 2t: Cochannel interference ratio (for normal BTS) at reference performance for QPSK, 16-QAM and 32-QAM modulated signals (Higher symbol rate and BTTI) (EGPRS2-B UL)

GSM 900, GSM 850 and MXM 850						
Type of channel		Propagation conditions				
		TU3 (no FH)	TU3 (ideal FH)	TU50 (no FH)	TU50 (ideal FH)	RA250 (no FH)
PDTCH/UBS-5	dB	-4,5 / [tbd]	(2)	-4,5 / [tbd]	-6,0 / [tbd]	-1,5 / [tbd]
PDTCH/UBS-6	dB	-2,0 / [tbd]	(2)	-3,0 / [tbd]	-3,5 / [tbd]	1,5 / [tbd]
PDTCH/UBS-7	dB	2,5 / [tbd]	(2)	1,5 / [tbd]	1,0 / [tbd]	5,5 / [tbd]
PDTCH/UBS-8	dB	4,5 / [tbd]	(2)	4,0 / [tbd]	3,5 / [tbd]	9,5 / [tbd]
PDTCH/UBS-9	dB	5,5 / [tbd]	(2)	5,5 / [tbd]	5,0 / [tbd]	13,0 / [tbd]
PDTCH/UBS-10	dB	11,0 / [tbd]	(2)	12,5 / [tbd]	12,0 / [tbd]	26,0 / [tbd]
PDTCH/UBS-11	dB	13,5 / [tbd]	(2)	16,5 / [tbd]	17,0 / [tbd]	35,0 / [tbd]
PDTCH/UBS-12	dB	15,0 / [tbd]	(2)	19,5 / [tbd]	19,5 / [tbd]	28,0** / [tbd]
DCS 1 800, PCS 1900 and MXM 1900						
Type of channel		Propagation conditions				
		TU1,5 (no FH)	TU1,5 (ideal FH)	TU50 (no FH)	TU50 (ideal FH)	RA130 (no FH)
PDTCH/UBS-5	dB	(2)	(2)	-4,5 / [tbd]	(2)	(2)
PDTCH/UBS-6	dB	(2)	(2)	-2,5 / [tbd]	(2)	(2)
PDTCH/UBS-7	dB	(2)	(2)	2,5 / [tbd]	(2)	(2)
PDTCH/UBS-8	dB	(2)	(2)	5,0 / [tbd]	(2)	(2)
PDTCH/UBS-9	dB	(2)	(2)	6,5 / [tbd]	(2)	(2)
PDTCH/UBS-10	dB	(2)	(2)	14,5 / [tbd]	(2)	(2)
PDTCH/UBS-11	dB	(2)	(2)	22,5 / [tbd]	(2)	(2)
PDTCH/UBS-12	dB	(2)	(2)	28,5 / [tbd]	(2)	(2)
<p>NOTE 1: Ideal FH case assumes perfect decorrelation between bursts. This case may only be tested if such a decorrelation is ensured in the test. For TU50 (ideal FH), sufficient decorrelation may be achieved with 4 frequencies spaced over 5 MHz. The TU3 (ideal FH) and TU1.5 (ideal FH), sufficient decorrelation cannot easily be achieved. These performance requirements are given for information purposes and need not be tested.</p> <p>NOTE 2: The requirements for the DCS 1800 & PCS 1900 TU1.5 (no FH) propagation condition are the same as for the GSM 850 & GSM 900 TU3 (no FH) propagation condition, the requirements for the GSM 850 & GSM 900 TU3 (ideal FH), DCS 1800 & PCS 1900 TU1.5 (ideal FH) and DCS 1800 & PCS 1900 TU50 (ideal FH) propagation conditions are the same as for the DCS 1800 & PCS 1900 TU50 (no FH) propagation condition, and the requirements for the DCS 1800 & PCS 1900 RA130 (no FH) propagation condition are the same as for the GSM 850 & GSM 900 RA250 (no FH) propagation condition.</p> <p>NOTE 3: RX diversity requirements are given by the left numbers. Requirements without RX diversity are given by the right numbers.</p>						

Table 2u: Cochannel interference ratio (for MS) at reference performance for QPSK, 16-QAM and 32-QAM modulated signals (Higher symbol rate, BTTI and turbo coding) (EGPRS2-B DL)

GSM 850 and GSM 900						
Type of channel		Propagation conditions				
		TU3 (no FH)	TU3 (ideal FH)	TU50 (no FH)	TU50 (ideal FH)	RA250 (no FH)
PDTCH/DBS-5	dB	17,0	(2)	15,0	12,0	12,0
PDTCH/DBS-6	dB	19,0	(2)	17,5	17,5	15,0
PDTCH/DBS-7	dB	22,5	(2)	20,0	19,5	19,0
PDTCH/DBS-8	dB	25,5	(2)	23,0	23,0	24,0
PDTCH/DBS-9	dB	27,0	(2)	26,0	25,5	27,0
PDTCH/DBS-10	dB	31,0	(2)	32,0	31,5	-
PDTCH/DBS-11	dB	34,0	(2)	31,0**	28,0**	-
PDTCH/DBS-12	dB	27,0**	(2)	34,5**	32,0**	-
USF/DBS-5 to 6	dB	[14,5]	(2)	[9,0]	[8,5]	[8,5]
USF/DBS-7 to 9	dB	[11,0]	(2)	[6,0]	[5,5]	[5,0]
USF/DBS-10 to 12	dB	[12,5]	(2)	[7,0]	[6,0]	[6,0]
DCS 1 800 and PCS 1900						
Type of channel		Propagation conditions				
		TU1,5 (no FH)	TU1,5 (ideal FH)	TU50 (no FH)	TU50 (ideal FH)	RA130 (no FH)
PDTCH/DBS-5	dB	(2)	(2)	12,0	(2)	(2)
PDTCH/DBS-6	dB	(2)	(2)	15,5	(2)	(2)
PDTCH/DBS-7	dB	(2)	(2)	19,0	(2)	(2)
PDTCH/DBS-8	dB	(2)	(2)	23,0	(2)	(2)
PDTCH/DBS-9	dB	(2)	(2)	22,0**	(2)	(2)
PDTCH/DBS-10	dB	(2)	(2)	30,0**	(2)	(2)
PDTCH/DBS-11	dB	(2)	(2)	-	(2)	(2)
PDTCH/DBS-12	dB	(2)	(2)	-	(2)	(2)
USF/DBS-5 to 6	dB	(2)	(2)	[8,5]	(2)	(2)
USF/DBS-7 to 9	dB	(2)	(2)	[5,5]	(2)	(2)
USF/DBS-10 to 12	dB	(2)	(2)	[6,5]	(2)	(2)
Performance is specified at 30% BLER for those cases identified with mark "**"						
Performance is not specified for those cases identified with mark "-"						
NOTE 1: Ideal FH case assumes perfect decorrelation between bursts. This case may only be tested if such a decorrelation is ensured in the test. For TU50 (ideal FH), sufficient decorrelation may be achieved with 4 frequencies spaced over 5 MHz.						
NOTE 2: The requirements for the DCS 1800 & PCS 1900 TU1.5 (no FH) propagation condition are the same as for the GSM 850 & GSM 900 TU3 (no FH) propagation condition, the requirements for the GSM 850 & GSM 900 TU3 (ideal FH), DCS 1800 & PCS 1900 TU1.5 (ideal FH) and DCS 1800 & PCS 1900 TU50 (ideal FH) propagation conditions are the same as for the DCS 1800 & PCS 1900 TU50 (no FH) propagation condition, and the requirements for the DCS 1800 & PCS 1900 RA130 (no FH) propagation condition are the same as for the GSM 850 & GSM 900 RA250 (no FH) propagation condition.						

Table 2v: Adjacent channel interference ratio (for normal BTS) at reference performance for 16-QAM modulated signals (Normal symbol rate and BTTI) (EGPRS2-A UL)

GSM 900, GSM 850 and MXM 850						
Type of channel		Propagation conditions				
		TU3 (no FH)	TU3 (ideal FH)	TU50 (no FH)	TU50 (ideal FH)	RA250 (no FH)
PDTCH/UAS-7	dB	13,0	(2)	9,5	8,0	10,5
PDTCH/UAS-8	dB	14,5	(2)	11,0	10,0	15,0
PDTCH/UAS-9	dB	15,5	(2)	13,5	12,5	22,5
PDTCH/UAS-10	dB	17,5	(2)	17,0	17,0	25,0**
PDTCH/UAS-11	dB	19,0	(2)	23,5	24,0	-
DCS 1 800, PCS 1900 and MXM 1900						
Type of channel		Propagation conditions				
		TU1,5 (no FH)	TU1,5 (ideal FH)	TU50 (no FH)	TU50 (ideal FH)	RA130 (no FH)
PDTCH/UAS-7	dB	(2)	(2)	9,5	(2)	(2)
PDTCH/UAS-8	dB	(2)	(2)	12,0	(2)	(2)
PDTCH/UAS-9	dB	(2)	(2)	15,5	(2)	(2)
PDTCH/UAS-10	dB	(2)	(2)	24,5	(2)	(2)
PDTCH/UAS-11	dB	(2)	(2)	20,5**	(2)	(2)
Performance is specified at 30% BLER for those cases identified with mark "**"						
Performance is not specified for those cases identified with mark "-"						
NOTE 1: Ideal FH case assumes perfect decorrelation between bursts. This case may only be tested if such a decorrelation is ensured in the test. For TU50 (ideal FH), sufficient decorrelation may be achieved with 4 frequencies spaced over 5 MHz. The TU3 (ideal FH) and TU1.5 (ideal FH), sufficient decorrelation cannot easily be achieved. These performance requirements are given for information purposes and need not be tested.						
NOTE 2: The requirements for the DCS 1800 & PCS 1900 TU1.5 (no FH) propagation condition are the same as for the GSM 850 & GSM 900 TU3 (no FH) propagation condition, the requirements for the GSM 850 & GSM 900 TU3 (ideal FH), DCS 1800 & PCS 1900 TU1.5 (ideal FH) and DCS 1800 & PCS 1900 TU50 (ideal FH) propagation conditions are the same as for the DCS 1800 & PCS 1900 TU50 (no FH) propagation condition, and the requirements for the DCS 1800 & PCS 1900 RA130 (no FH) propagation condition are the same as for the GSM 850 & GSM 900 RA250 (no FH) propagation condition.						

Table 2w: Adjacent channel interference ratio (for MS) at reference performance for 8-PSK, 16-QAM and 32-QAM modulated signals (Normal symbol rate and Turbo coding) (EGPRS2-A DL)

GSM 850 and GSM 900						
Type of channel		Propagation conditions				
		TU3 (no FH)	TU3 (ideal FH)	TU50 (no FH)	TU50 (ideal FH)	RA250 (no FH)
PDTCH/DAS-5	dB	3	(2)	-2,0	-3,0	-3
PDTCH/DAS-6	dB	3,5	(2)	-0,5	-1,5	-1
PDTCH/DAS-7	dB	4,5	(2)	1,5	0,5	2
PDTCH/DAS-8	dB	7,5	(2)	4,5	4	5,5
PDTCH/DAS-9	dB	9,0	(2)	7,5	7	14,5
PDTCH/DAS-10	dB	12,5	(2)	12	12	14,0**
PDTCH/DAS-11	dB	15,5	(2)	19	19,5	-
PDTCH/DAS-12	dB	17,5	(2)	19,5**	17,5**	-
USF/DAS-5 to 7	dB	(3)	(3)	(3)	(3)	(3)
USF/DAS-8 to 9	dB	-6,0	(2)	-14,0	-15,5	-16,0
USF/DAS-10 to 12	dB	-5,5	(2)	-13,0	-14,5	-14,0
DCS 1 800 and PCS 1900						
Type of channel		Propagation conditions				
		TU1,5 (no FH)	TU1,5 (ideal FH)	TU50 (no FH)	TU50 (ideal FH)	RA130 (no FH)
PDTCH/DAS-5	dB	(2)	(2)	-2,5	(2)	(2)
PDTCH/DAS-6	dB	(2)	(2)	-0,5	(2)	(2)
PDTCH/DAS-7	dB	(2)	(2)	1,5	(2)	(2)
PDTCH/DAS-8	dB	(2)	(2)	5,0	(2)	(2)
PDTCH/DAS-9	dB	(2)	(2)	9,0	(2)	(2)
PDTCH/DAS-10	dB	(2)	(2)	16,0	(2)	(2)
PDTCH/DAS-11	dB	(2)	(2)	22,0**	(2)	(2)
PDTCH/DAS-12	dB	(2)	(2)	-	(2)	(2)
USF/DAS-5 to 7	dB	(3)	(3)	(3)	(3)	(3)
USF/DAS-8 to 9	dB	(2)	(2)	-14,0	(2)	(2)
USF/DAS-10 to 12	dB	(2)	(2)	-13,5	(2)	(2)
Performance is specified at 30% BLER for those cases identified with mark "**"						
Performance is not specified for those cases identified with mark "-"						
NOTE 1: Ideal FH case assumes perfect decorrelation between bursts. This case may only be tested if such a decorrelation is ensured in the test. For TU50 (ideal FH), sufficient decorrelation may be achieved with 4 frequencies spaced over 5 MHz.						
NOTE 2: The requirements for the DCS 1800 & PCS 1900 TU1.5 (no FH) propagation condition are the same as for the GSM 850 & GSM 900 TU3 (no FH) propagation condition, the requirements for the GSM 850 & GSM 900 TU3 (ideal FH), DCS 1800 & PCS 1900 TU1.5 (ideal FH) and DCS 1800 & PCS 1900 TU50 (ideal FH) propagation conditions are the same as for the DCS 1800 & PCS 1900 TU50 (no FH) propagation condition, and the requirements for the DCS 1800 & PCS 1900 RA130 (no FH) propagation condition are the same as for the GSM 850 & GSM 900 RA250 (no FH) propagation condition.						
NOTE 3: The requirements for USF/DAS-5 to 7 are the same as for USF/MCS-5 to 9.						

Table 2x: Adjacent channel interference ratio (for normal BTS) at reference performance for QPSK, 16-QAM and 32-QAM modulated signals (Higher symbol rate, BTTI and no PAN) using narrow pulse shaping filter (EGPRS2-B UL)

GSM 900, GSM 850 and MXM 850						
Type of channel	Propagation conditions					
	TU3 (no FH)	TU3 (ideal FH)	TU50 (no FH)	TU50 (ideal FH)	RA250 (no FH)	
PDTCH/UBS-5	dB	-14,5 / [tbd]	(2)	-14,0 / [tbd]	-14,0 / [tbd]	-2,5 / [tbd]
PDTCH/UBS-6	dB	-12,0 / [tbd]	(2)	-11,0 / [tbd]	-11,5 / [tbd]	1,5 / [tbd]
PDTCH/UBS-7	dB	-1,5 / [tbd]	(2)	-2,5 / [tbd]	-3,0 / [tbd]	7,0 / [tbd]
PDTCH/UBS-8	dB	1,0 / [tbd]	(2)	0,5 / [tbd]	0,5 / [tbd]	11,0 / [tbd]
PDTCH/UBS-9	dB	2,5 / [tbd]	(2)	2,0 / [tbd]	2,0 / [tbd]	12,5 / [tbd]
PDTCH/UBS-10	dB	7,0 / [tbd]	(2)	9,0 / [tbd]	9,0 / [tbd]	18,0 / [tbd]
PDTCH/UBS-11	dB	8,5 / [tbd]	(2)	13,0 / [tbd]	13,5 / [tbd]	18,5** / [tbd]
PDTCH/UBS-12	dB	9,0 / [tbd]	(2)	14,5 / [tbd]	15,0 / [tbd]	22,5** / [tbd]
DCS 1 800, PCS 1900 and MXM 1900						
Type of channel	Propagation conditions					
	TU1,5 (no FH)	TU1,5 (ideal FH)	TU50 (no FH)	TU50 (ideal FH)	RA130 (no FH)	
PDTCH/UBS-5	dB	(2)	(2)	-10,0 / [tbd]	(2)	(2)
PDTCH/UBS-6	dB	(2)	(2)	-6,5 / [tbd]	(2)	(2)
PDTCH/UBS-7	dB	(2)	(2)	2,0 / [tbd]	(2)	(2)
PDTCH/UBS-8	dB	(2)	(2)	5,0 / [tbd]	(2)	(2)
PDTCH/UBS-9	dB	(2)	(2)	7,0 / [tbd]	(2)	(2)
PDTCH/UBS-10	dB	(2)	(2)	14,0 / [tbd]	(2)	(2)
PDTCH/UBS-11	dB	(2)	(2)	12,5** / [tbd]	(2)	(2)
PDTCH/UBS-12	dB	(2)	(2)	14,0** / [tbd]	(2)	(2)
NOTE 1: Ideal FH case assumes perfect decorrelation between bursts. This case may only be tested if such a decorrelation is ensured in the test. For TU50 (ideal FH), sufficient decorrelation may be achieved with 4 frequencies spaced over 5 MHz. The TU3 (ideal FH) and TU1.5 (ideal FH), sufficient decorrelation cannot easily be achieved. These performance requirements are given for information purposes and need not be tested.						
NOTE 2: The requirements for the DCS 1800 & PCS 1900 TU1.5 (no FH) propagation condition are the same as for the GSM 850 & GSM 900 TU3 (no FH) propagation condition, the requirements for the GSM 850 & GSM 900 TU3 (ideal FH), DCS 1800 & PCS 1900 TU1.5 (ideal FH) and DCS 1800 & PCS 1900 TU50 (ideal FH) propagation conditions are the same as for the DCS 1800 & PCS 1900 TU50 (no FH) propagation condition, and the requirements for the DCS 1800 & PCS 1900 RA130 (no FH) propagation condition are the same as for the GSM 850 & GSM 900 RA250 (no FH) propagation condition.						
NOTE 3: RX diversity requirements are given by the left numbers. Requirements without RX diversity are given by the right numbers.						

Table 2y: Adjacent channel interference ratio (for MS) at reference performance for QPSK, 16-QAM and 32-QAM modulated signals (Higher symbol rate, BTTI, turbo coding and no PAN) using narrow pulse shaping filter (EGPRS2-B DL)

GSM 850 and GSM 900						
Type of channel	Propagation conditions					
	TU3 (no FH)	TU3 (ideal FH)	TU50 (no FH)	TU50 (ideal FH)	RA250 (no FH)	
PDTCH/DBS-5	dB	[-4,0]	(2)	[-7,0]	[-7,5]	[-8,0]
PDTCH/DBS-6	dB	[-2,0]	(2)	[-4,0]	[-4,5]	[-4,0]
PDTCH/DBS-7	dB	[5,0]	(2)	[1,5]	[0,5]	[2,0]
PDTCH/DBS-8	dB	[8,0]	(2)	[5,5]	[5,0]	[10,0]
PDTCH/DBS-9	dB	[10,0]	(2)	[8,5]	[8,0]	[20,5]
PDTCH/DBS-10	dB	[18,5]	(2)	[17,0]	[17,5]	[-]
PDTCH/DBS-11	dB	[22,5]	(2)	[29,5]	[30,0]	[-]
PDTCH/DBS-12	dB	[27,5]	(2)	[23**]	[24**]	[-]
USF/DBS-5 to 6	dB	[-3,0]	(2)	[-8,0]	[-9,0]	[-9,5]
USF/DBS-7 to 9	dB	[-5,0]	(2)	[-11,5]	[-12,5]	[-13,0]

USF/DBS-10 to 12	dB	[-4,5]	(2)	[-10,5]	[-11,0]	[-11,5]
DCS 1 800 and PCS 1900						
Type of channel	Propagation conditions					
		TU1,5 (no FH)	TU1,5 (ideal FH)	TU50 (no FH)	TU50 (ideal FH)	RA130 (no FH)
PDTCH/DBS-5	dB	(2)	(2)	[-7,5]	(2)	(2)
PDTCH/DBS-6	dB	(2)	(2)	[-4,0]	(2)	(2)
PDTCH/DBS-7	dB	(2)	(2)	[1,5]	(2)	(2)
PDTCH/DBS-8	dB	(2)	(2)	[6,0]	(2)	(2)
PDTCH/DBS-9	dB	(2)	(2)	[9,5]	(2)	(2)
PDTCH/DBS-10	dB	(2)	(2)	[22,0]	(2)	(2)
PDTCH/DBS-11	dB	(2)	(2)	[24,5**]	(2)	(2)
PDTCH/DBS-12	dB	(2)	(2)	[-]	(2)	(2)
USF/DBS-5 to 6	dB	(2)	(2)	[-8,5]	(2)	(2)
USF/DBS-7 to 9	dB	(2)	(2)	[-12,0]	(2)	(2)
USF/DBS-10 to 12	dB	(2)	(2)	[-11,5]	(2)	(2)
Performance is specified at 30% BLER for those cases identified with mark **.						
Performance is not specified for those cases identified with mark "-"						
NOTE 1: Ideal FH case assumes perfect decorrelation between bursts. This case may only be tested if such a decorrelation is ensured in the test. For TU50 (ideal FH), sufficient decorrelation may be achieved with 4 frequencies spaced over 5 MHz.						
NOTE 2: The requirements for the DCS 1800 & PCS 1900 TU1.5 (no FH) propagation condition are the same as for the GSM 850 & GSM 900 TU3 (no FH) propagation condition, the requirements for the GSM 850 & GSM 900 TU3 (ideal FH), DCS 1800 & PCS 1900 TU1.5 (ideal FH) and DCS 1800 & PCS 1900 TU50 (ideal FH) propagation conditions are the same as for DCS 1800 & PCS 1900 TU50 (no FH) propagation condition, and the requirements for the DCS 1800 & PCS 1900 RA130 (no FH) propagation condition are the same as for the GSM 850 & GSM 900 RA250 (no FH) propagation condition.						

Table 2z: Adjacent channel interference ratio (for normal BTS) at reference performance for QPSK, 16-QAM and 32-QAM modulated signals (Higher symbol rate, BTTI and no PAN) using wide pulse shaping filter (EGPRS2-B UL)

GSM 900, GSM 850 and MXM 850						
Type of channel		Propagation conditions				
		TU3 (no FH)	TU3 (ideal FH)	TU50 (no FH)	TU50 (ideal FH)	RA250 (no FH)
PDTCH/UBS-5	dB	-17,5 / [tbd]	(2)	-16,5 / [tbd]	-17,0 / [tbd]	-9,0 / [tbd]
PDTCH/UBS-6	dB	-15,0 / [tbd]	(2)	-14,0 / [tbd]	-14,5 / [tbd]	-5,5 / [tbd]
PDTCH/UBS-7	dB	-11,5 / [tbd]	(2)	-9,5 / [tbd]	-9,5 / [tbd]	-2,5 / [tbd]
PDTCH/UBS-8	dB	-8,0 / [tbd]	(2)	-6,0 / [tbd]	-6,0 / [tbd]	1,5 / [tbd]
PDTCH/UBS-9	dB	-6,0 / [tbd]	(2)	-3,5 / [tbd]	-4,0 / [tbd]	4,0 / [tbd]
PDTCH/UBS-10	dB	0,0 / [tbd]	(2)	1,0 / [tbd]	1,0 / [tbd]	12,5 / [tbd]
PDTCH/UBS-11	dB	5,5 / [tbd]	(2)	9,0 / [tbd]	9,0 / [tbd]	25,0 / [tbd]
PDTCH/UBS-12	dB	8,0 / [tbd]	(2)	13,5 / [tbd]	12,5 / [tbd]	16,5** / [tbd]
DCS 1 800, PCS 1900 and MXM 1900						
Type of channel		Propagation conditions				
		TU1,5 (no FH)	TU1,5 (ideal FH)	TU50 (no FH)	TU50 (ideal FH)	RA130 (no FH)
PDTCH/UBS-5	dB	(2)	(2)	-13,0 / [tbd]	(2)	(2)
PDTCH/UBS-6	dB	(2)	(2)	-10,0 / [tbd]	(2)	(2)
PDTCH/UBS-7	dB	(2)	(2)	-5,5 / [tbd]	(2)	(2)
PDTCH/UBS-8	dB	(2)	(2)	-2,0 / [tbd]	(2)	(2)
PDTCH/UBS-9	dB	(2)	(2)	1,5 / [tbd]	(2)	(2)
PDTCH/UBS-10	dB	(2)	(2)	5,0 / [tbd]	(2)	(2)
PDTCH/UBS-11	dB	(2)	(2)	14,5 / [tbd]	(2)	(2)
PDTCH/UBS-12	dB	(2)	(2)	20,0 / [tbd]	(2)	(2)
<p>NOTE 1: Ideal FH case assumes perfect decorrelation between bursts. This case may only be tested if such a decorrelation is ensured in the test. For TU50 (ideal FH), sufficient decorrelation may be achieved with 4 frequencies spaced over 5 MHz. The TU3 (ideal FH) and TU1.5 (ideal FH), sufficient decorrelation cannot easily be achieved. These performance requirements are given for information purposes and need not be tested.</p> <p>NOTE 2: The requirements for the DCS 1800 & PCS 1900 TU1.5 (no FH) propagation condition are the same as for the GSM 850 & GSM 900 TU3 (no FH) propagation condition, the requirements for the GSM 850 & GSM 900 TU3 (ideal FH), DCS 1800 & PCS 1900 TU1.5 (ideal FH) and DCS 1800 & PCS 1900 TU50 (ideal FH) propagation conditions are the same as for the DCS 1800 & PCS 1900 TU50 (no FH) propagation condition, and the requirements for the DCS 1800 & PCS 1900 RA130 (no FH) propagation condition are the same as for the GSM 850 & GSM 900 RA250 (no FH) propagation condition.</p> <p>NOTE 3: RX diversity requirements are given by the left numbers. Requirements without RX diversity are given by the right numbers.</p>						

Table 2aa: C/I1 ratio at reference performance for VAMOS IMS for voice channels in VAMOS mode

Propagation conditions		TU50 no FH					
VAMOS Test Scenario (see AnnexQ)		VDTS-1					
		GSM 900 and GSM 850			DCS 1800 & PCS 1900		
SCPIR_DL		+4 dB	0 dB	-4 dB	+4 dB	0 dB	-4 dB
TCH/HS	FER (dB)	11,5	12,5	15,5	11,5	12,5	15,5
	RBER1b	0,1 %	0,24 %	0,08 %	0,1 %	0,23 %	0,21 %
	RBER2	3,9 %	4,7 %	4,12 %	4 %	4,65 %	4,62 %
TCH/EFS	FER (dB)	12	13,5	16,5	11	13	15,5
	RBER1b	0,04 %	0,06 %	0,03 %	0,06 %	0,06 %	0,07 %
	RBER2	3,62 %	3,77 %	3,55 %	4,61 %	4,62 %	4,77 %
TCH/AFS12.2	FER (dB)	12	13,5	16,5	11,5	13	15,5
	RBER1b	0,49 %	0,51 %	0,53 %	0,69 %	0,65 %	0,7 %
TCH/AFS4.75	FER (dB)	6,5	8	10,5	5	6,5	9
	RBER1b	0,12 %	0,1 %	0,1 %	0,14 %	0,17 %	0,13 %
TCH/AHS7.4	FER (dB)	15	17	19,5	15,5	17,5	20,5
	RBER1b	0,15 %	0,15 %	0,16 %	0,15 %	0,14 %	0,15 %
	RBER2	1,6 %	1,61 %	1,75 %	1,64 %	1,6 %	1,58 %
TCH/AHS4.75	FER (dB)	10,5	12	14,5	10,5	12	15
	RBER1b	0,14 %	0,1 %	0,12 %	0,13 %	0,12 %	0,11 %
	RBER2	5,22 %	4,5 %	5,18 %	5,44 %	5,17 %	5,17 %
TCH/WFS12.65	FER (dB)	12	13,5	16,5	11,5	13	15,5
	RBER1b	0,44 %	0,45 %	0,39 %	0,48 %	0,54 %	0,47 %
TCH/WFS6.60	FER (dB)	8,5	10	12,5	7	8,5	11
	RBER1b	0,11 %	0,14 %	0,22 %	0,21 %	0,21 %	0,31 %
FACCH/F	FER	9,5	11,5	14,5	8,5	10,5	13,5
FACCH/H	FER	9	11	14	9	11	13,5
SACCH	FER	9,5	11,5	15	9,5	11,5	15
Repeated FACCH/F	FER	-	7	-	-	6,5	-
Repeated SACCH	FER	-	5	-	-	5	-

Propagation conditions		TU50 no FH					
VAMOS Test Scenario (see AnnexQ)		VDTS-2					
		GSM 900 and GSM 850			DCS 1800 & PCS 1900		
SCPIR_DL		+4 dB	0 dB	-4 dB	+4 dB	0 dB	-4 dB
TCH/HS	FER (dB)	12,5	14,5	17,5	12,5	15	18
	RBER1b	0,22 %	0,25 %	0,22 %	0,29 %	0,1 %	0,22 %
	RBER2	4,86 %	4,9 %	4,74 %	5,4 %	3,6 %	4,73 %
TCH/EFS	FER (dB)	14	15,5	19	13	14,5	17,5
	RBER1b	0,03 %	0,03 %	0,04 %	0,07 %	0,06 %	0,08 %
	RBER2	3,47 %	3,59 %	3,35 %	4,74 %	5,02 %	5,12 %
TCH/AFS4.75	FER (dB)	8,5	10	13	7,5	9	11,5
	RBER1b	0,12 %	0,12 %	0,12 %	0,14 %	0,14 %	0,14 %
TCH/AHS7.4	FER (dB)	17	19	21,5	17,5	19,5	22,5
	RBER1b	0,13 %	0,13 %	0,16 %	0,14 %	0,14 %	0,16 %
	RBER2	1,58 %	1,6 %	1,82 %	1,65 %	1,66 %	1,69 %
TCH/WFS12.65	FER (dB)	14,5	16,5	19	13,5	15,5	18
	RBER1b	0,34 %	0,31 %	0,31 %	0,44 %	0,45 %	0,59 %

Propagation conditions		TU50 no FH					
VAMOS Test Scenario (see AnnexQ)		VDTS-3					
		GSM 900 and GSM 850			DCS 1800 & PCS 1900		
SCPIR_DL		+4 dB	0 dB	-4 dB	+4 dB	0 dB	-4 dB
TCH/HS	FER (dB)	9,5	11,5	16	10	12	16
	RBER1b	0,24 %	0,24 %	0,07 %	0,24 %	0,28 %	0,08 %
	RBER2	5,15 %	5,01 %	3,99 %	5 %	4,99 %	4,07 %
TCH/EFS	FER (dB)	11,5	13	16	10	12	15
	RBER1b	0,03 %	0,03 %	0,03 %	0,04 %	0,03 %	0,03 %
	RBER2	3,95 %	3,62 %	3,67 %	4,89 %	4,92 %	4,95 %
TCH/AFS4.75	FER (dB)	5	6,5	9	3	5	7,5
	RBER1b	0,1 %	0,11 %	0,15 %	0,15 %	0,15 %	0,2 %
TCH/AHS7.4	FER (dB)	13,5	16	19,5	14	16,5	20
	RBER1b	0,13 %	0,14 %	0,14 %	0,15 %	0,16 %	0,16 %
	RBER2	1,74 %	1,75 %	1,78 %	1,74 %	1,81 %	1,84 %
TCH/WFS12.65	FER (dB)	11	13,5	16,5	10	12,5	15,5
	RBER1b	0,42 %	0,4 %	0,38 %	0,62 %	0,59 %	0,3 %

Propagation conditions		TU50 no FH					
VAMOS Test Scenario (see AnnexQ)		VDTS-4					
		GSM 900 and GSM 850			DCS 1800 & PCS 1900		
SCPIR_DL		+4 dB	0 dB	-4 dB	+4 dB	0 dB	-4 dB
TCH/HS	FER (dB)	-11	-6,5	-0,5	-10,5	-6	1
	RBER1b	0,26 %	0,25 %	0,25 %	0,24 %	0,25 %	0,23 %
	RBER2	4,55 %	4,74 %	4,79 %	4,64 %	4,86 %	4,72 %
TCH/EFS	FER (dB)	-8,5	-4,5	2	-9,5	-5,5	1
	RBER1b	0,05 %	0,03 %	0,03 %	0,05 %	0,03 %	0,04 %
	RBER2	3,58 %	3,89 %	3,8 %	4,29 %	4,8 %	4,82 %
TCH/AFS 4.75	FER (dB)	-16,5	-13,5	-8	-18	-15	-9
	RBER1b	0,1 %	0,13 %	0,13 %	0,15 %	0,15 %	0,17 %
TCH/AHS 7.4	FER (dB)	-2,5	2,5	7	-2	3,5	9
	RBER1b	0,13 %	0,13 %	0,14 %	0,19 %	0,16 %	0,2 %
	RBER2	1,66 %	1,59 %	1,59 %	1,75 %	1,68 %	2 %
TCH/WFS 12.65	FER (dB)	-8	-3,5	2	-9	-5	1,5
	RBER1b	0,37 %	0,32 %	0,47 %	0,55 %	0,48 %	0,63 %

Table 2ab: C/I1 ratio at reference performance for VAMOS II MS for voice channels in VAMOS mode

GSM 900 and GSM 850						
VAMOS Test Scenario (see AnnexQ)		VDTS-1				
Propagation condition		TU50 noFH				
SCPIR_DL		+4 dB	0 dB	-4 dB	-8 dB	-10 dB
TCH/HS	FER (dB)	10	11,5	13,5	17,5	19
	Rber1b	0,09 %	0,2 %	0,21 %	0,2 %	0,22 %
	Rber2	4,24 %	5,29 %	5,59 %	5,42 %	5,7 %
TCH/EFS	FER (dB)	11,5	13	15,5	19	21
	Rber1b	0,05 %	0,04 %	0,06 %	0,04 %	0,06 %
	Rber2	3,73 %	3,6 %	3,77 %	3,66 %	4,06 %
TCH/AFS12.2	FER (dB)	11,5	13	15,5	19	21
	Rber1b	0,45 %	0,45 %	0,47 %	0,4 %	0,47 %
TCH/AFS4.75	FER (dB)	5,5	7	9	13	15
	Rber1b	0,14 %	0,13 %	0,14 %	0,11 %	0,12 %
TCH/AHS7.4	FER (dB)	14	16	18,5	22	24
	Rber1b	0,16 %	0,12 %	0,13 %	0,17 %	0,17 %
	Rber2	1,67 %	1,56 %	1,61 %	1,92 %	2,01 %
TCH/AHS4.75	FER (dB)	9,5	11	13,5	17	18,5
	Rber1b	0,15 %	0,13 %	0,15 %	0,15 %	0,19 %
	Rber2	5,42 %	5,52 %	5,87 %	5,85 %	6,34 %
TCH/WFS12.65	FER (dB)	11,5	13	15,5	19	21
	Rber1b	0,34 %	0,36 %	0,38 %	0,36 %	0,36 %
TCH/WFS6.60	FER (dB)	7,5	9	11,5	15,5	17
	Rber1b	0,2 %	0,2 %	0,13 %	0,13 %	0,15 %
FACCH/F	FER	9,5	11,5	13,5	17	18,5
FACCH/H	FER	9	11	13,5	16,5	18,5
SACCH	FER	9,5	11,5	14	17	19
Repeated FACCH/F	FER	-	7	-	-	-
Repeated SACCH	FER	-	5	-	-	-

GSM 900 and GSM 850						
VAMOS Test Scenario (see AnnexQ)		VDTS-2				
Propagation condition		TU50 noFH				
SCPIR_DL		+4 dB	0 dB	-4 dB	-8 dB	-10 dB
TCH/HS	FER (dB)	11,5	13	15,5	19	21
	Rber1b	0,18 %	0,18 %	0,2 %	0,21 %	0,12 %
	Rber2	5,03 %	4,97 %	5,2 %	5,21 %	5 %
TCH/EFS	FER (dB)	13	15	17	20	22
	Rber1b	0,03 %	0,03 %	0,04 %	0,05 %	0,04 %
	Rber2	3,58 %	3,45 %	3,8 %	4,25 %	4,17 %
TCH/AFS4.75	FER (dB)	7	8,5	11	14,5	16
	Rber1b	0,11 %	0,16 %	0,14 %	0,11 %	0,09 %
TCH/AHS7.4	FER (dB)	15,5	17,5	19	23,5	25
	Rber1b	0,15 %	0,15 %	0,1 %	0,12 %	0,12 %
	Rber2	1,84 %	1,82 %	1,89 %	2,03 %	2,15 %
TCH/WFS12.65	FER (dB)	13	15	17	20	22
	Rber1b	0,39 %	0,34 %	0,36 %	0,4 %	0,4 %

GSM 900 and GSM 850						
VAMOS Test Scenario (see AnnexQ)		VDTS-3				
Propagation condition		TU50 noFH				
SCPIR_DL		+4 dB	0 dB	-4 dB	-8 dB	-10 dB
TCH/HS	FER (dB)	9,5	11	13,5	17,5	19
	Rber1b	0,05 %	0,21 %	0,23 %	0,26 %	0,24 %
	Rber2	4,81 %	4,96 %	5 %	5,5 %	5,5 %
TCH/EFS	FER (dB)	10	12	15	18,5	20,5
	Rber1b	0,05 %	0,05 %	0,07 %	0,07 %	0,06 %
	Rber2	4,23 %	3,85 %	3,75 %	3,69 %	3,76 %
TCH/AFS4.75	FER (dB)	4,5	6	8,5	11,5	13,5
	Rber1b	0,18 %	0,21 %	0,18 %	0,18 %	0,21 %
TCH/AHS7.4	FER (dB)	13	15	18	21,5	23,5
	Rber1b	0,2 %	0,21 %	0,23 %	0,26 %	0,24 %
	Rber2	2,11 %	2 %	2 %	2,2 %	2,5 %
TCH/WFS12.65	FER (dB)	10	13	15	19	21
	Rber1b	0,4 %	0,38 %	0,43 %	0,42 %	0,42 %

GSM 900 and GSM 850						
VAMOS Test Scenario (see AnnexQ)		VDTS-4				
Propagation condition		TU50 noFH				
SCPIR_DL		+4 dB	0 dB	-4 dB	-8 dBb	-10 dB
TCH/HS	FER (dB)	-11,5	-8	-3,5	-3,5	-0,5
	Rber1b	0,24 %	0,24 %	0,22 %	0,14 %	0,17 %
	Rber2	5,09 %	5,12 %	5,05 %	5,9 %	6,51 %
TCH/EFS	FER (dB)	-8,5	-5	-0,5	-2,5	1
	Rber1b	0,05 %	0,06 %	0,05 %	0,04 %	0,03 %
	Rber2	3,58 %	3,75 %	3,74 %	4,99 %	3,19 %
TCH/AFS4.75	FER (dB)	-18,5	-15	-12	-10,5	-8,5
	Rber1b	0,22 %	0,14 %	0,13 %	0,18 %	0,17 %
TCH/AHS7.4	FER (dB)	-9,5	-2	0	2,5	7
	Rber1b	0,2 %	0,16 %	0,11 %	0,27 %	0,12 %
	Rber2	2,16 %	1,67 %	1,18 %	2,97 %	1,74 %
TCH/WFS12.65	FER (dB)	-8	-3,5	0	-3	0,5
	Rber1b	0,37 %	0,32 %	0,39 %	0,73 %	0,46 %

DCS 1800 & PCS 1900						
VAMOS Test Scenario (see AnnexQ)		VDTS-1				
Propagation condition		TU50 noFH				
SCPIR_DL		+4 dB	0 dB	-4 dB	-8 dB	-10 dB
TCH/HS	FER (dB)	10	11,5	14	18	19,5
	Rber1b	0,17 %	0,19 %	0,2 %	0,2 %	0,21 %
	Rber2	5,24 %	5,46 %	5,8 %	5,71 %	5,96 %
TCH/EFS	FER (dB)	10	11,5	14,5	18	20
	Rber1b	0,05 %	0,04 %	0,06 %	0,04 %	0,04 %
	Rber2	5,02 %	5,35 %	5,32 %	5,33 %	5,58 %
TCH/AFS12.2	FER (dB)	10,5	12	14,5	18	20
	Rber1b	0,76 %	0,74 %	0,74 %	0,8 %	0,85 %
TCH/AFS4.75	FER (dB)	3,5	5,5	7,5	11,5	13,5
	Rber1b	0,11 %	0,12 %	0,17 %	0,12 %	0,13 %
TCH/AHS7.4	FER (dB)	14,5	16	18,5	23	24,5
	Rber1b	0,16 %	0,14 %	0,12 %	0,15 %	0,16 %
	Rber2	1,69 %	1,77 %	1,79 %	1,92 %	2,28 %
TCH/AHS4.75	FER (dB)	9,5	11	13,5	17,5	19,5
	Rber1b	0,12 %	0,13 %	0,11 %	0,13 %	0,12 %
	Rber2	5,78 %	5,85 %	6 %	6,09 %	6,41 %
TCH/WFS12.65	FER (dB)	10,5	12	15	18,5	20
	Rber1b	0,49 %	0,53 %	0,52 %	0,64 %	0,6 %
TCH/WFS6.60	FER (dB)	6	7,5	10	14	16
	Rber1b	0,27 %	0,28 %	0,21 %	0,15 %	0,17 %
FACCH/F	FER	8,5	10,5	13	16	18
FACCH/H	FER	9	11	13,5	17	19
SACCH	FER	9,5	11,5	14	17,5	19,5
Repeated FACCH/F	FER	-	6,5	-	-	-
Repeated SACCH	FER	-	5	-	-	-

DCS 1800 & PCS 1900						
VAMOS Test Scenario (see AnnexQ)		VDTS-2				
Propagation condition		TU50 noFH				
SCPIR_DL		+4 dB	0 dB	-4 dB	-8 dB	-10 dB
TCH/HS	FER (dB)	11,5	13	15,5	19	21
	Rber1b	0,19 %	0,2 %	0,2 %	0,25 %	0,26 %
	Rber2	5,52 %	5,61 %	5,73 %	5,92 %	6,31 %
TCH/EFS	FER (dB)	12	13,5	16	19,5	21,5
	Rber1b	0,03 %	0,07 %	0,06 %	0,05 %	0,05 %
	Rber2	4,57 %	4,89 %	5,16 %	5,38 %	5,62 %
TCH/AFS4.75	FER (dB)	6	7,5	9,5	13	15
	Rber1b	0,15 %	0,15 %	0,15 %	0,19 %	0,13 %
TCH/AHS7.4	FER (dB)	16	17,5	20	24	26,5
	Rber1b	0,12 %	0,13 %	0,14 %	0,16 %	0,15 %
	Rber2	1,85 %	1,96 %	2,01 %	2,25 %	2,36 %
TCH/WFS12.65	FER (dB)	12	13,5	16	20	22
	Rber1b	0,46 %	0,57 %	0,54 %	0,43 %	0,52 %

DCS 1800 & PCS 1900						
VAMOS Test Scenario (see AnnexQ)		VDTS-3				
Propagation condition		TU50 noFH				
SCPIR_DL		+4 dB	0 dB	-4 dB	-8 dB	-10 dB
TCH/HS	FER (dB)	9,5	11,5	14	18	20
	Rber1b	0,2 %	0,21 %	0,21 %	0,19 %	0,2 %
	Rber2	4,88 %	4,55 %	5 %	5,5 %	5,5 %
TCH/EFS	FER (dB)	9	10,5	14	18	19,5
	Rber1b	0,04 %	0,06 %	0,05 %	0,07 %	0,05 %
	Rber2	5,27 %	5,4 %	4,33 %	4,77 %	4,85 %
TCH/AFS4.75	FER (dB)	2,5	4,5	7	10,5	12,5
	Rber1b	0,18 %	0,11 %	0,15 %	0,16 %	0,16 %
TCH/AHS7.4	FER (dB)	13,5	16	18,5	22,5	24,5
	Rber1b	0,23 %	0,22 %	0,23 %	0,22 %	0,21 %
	Rber2	2 %	2 %	2 %	2,2 %	2,5 %
TCH/WFS12.65	FER (dB)	9	11,5	14	18	20
	Rber1b	0,63 %	0,51 %	0,5 %	0,44 %	0,48 %

DCS 1800 & PCS 1900						
VAMOS Test Scenario (see AnnexQ)		VDTS-4				
Propagation condition		TU50 noFH				
SCPIR_DL		+4 dB	0 dB	-4 dB	-8 dB	-10 dB
TCH/HS	FER (dB)	-11	-7,5	-2,5	-1	1,5
	Rber1b	0,23 %	0,24 %	0,22 %	0,14 %	0,15 %
	Rber2	5,11 %	5,2 %	5,2 %	4,19 %	5,11 %
TCH/EFS	FER (dB)	-9,5	-6	-1	-2	2
	Rber1b	0,05 %	0,06 %	0,06 %	0,03 %	0,04 %
	Rber2	4,29 %	4,55 %	4,61 %	3,98 %	4,09 %
TCH/AFS4.75	FER (dB)	-19,5	-16,5	-13,5	-11,5	-9,5
	Rber1b	0,21 %	0,16 %	0,21 %	0,22 %	0,22 %
TCH/AHS7.4	FER (dB)	-9,5	-1	0	4,5	9,5
	Rber1b	0,2 %	0,18 %	0,23 %	0,17 %	0,25 %
	Rber2	2,18 %	1,76 %	2,5 %	1,9 %	2,95 %
TCH/WFS12.65	FER (dB)	-9	-5	-0,5	-2,5	1
	Rber1b	0,55 %	0,48 %	0,57 %	0,52 %	0,54 %

Table 2ac: C/I1 ratio at reference performance (for BTS) for voice channels in VAMOS mode

GSM 900 and GSM 850									
VAMOS Test Scenario (see Annex Q)		VUTS-1		VUTS-2		VUTS-3		VUTS-4	
Propagation condition		TU50 noFH		TU50 noFH		TU50 noFH		TU50 noFH	
SCPIR_UL		0 dB	-10 dB	0 dB	-10 dB	0 dB	-10 dB	0 dB	-10 dB
TCH/HS	FER (dB)	11	11.5	-6.5	-8	11.5	11	7	6
	Rber1b	0.20%	0.10%	0.16%	0.13%	0.24%	0.19%	0.23%	0.15%
	Rber2	4.52%	4.50%	3.54%	3.90%	4.51%	4.95%	3.74%	5.00%
TCH/EFS	FER (dB)	13.5	12.5	-3.5	-7	14	13	10	7
	Rber1b	0.04%	0.04%	0.04%	0.04%	0.04%	0.04%	0.04%	0.05%
	Rber2	2.75%	3.30%	3.10%	3.40%	3.30%	3.50%	2.70%	3.70%
TCH/AFS 12.2	FER (dB)	13	12	-4.5	-7.5	13.5	12.5	9.5	6.5
	Rber1b	0.46%	0.53%	0.45%	0.63%	0.53%	0.58%	0.31%	0.42%
TCH/AFS 4.75	FER (dB)	7	-	-12.5	-	6	-	3.5	-
	Rber1b	0.12%	-	0.10%	-	0.21%	-	0.13%	-
TCH/AHS 7.4	FER (dB)	15	14.5	-1	-3	16.5	15	12	10.5
	Rber1b	0.17%	0.18%	0.14%	0.22%	0.18%	0.22%	0.13%	0.15%
	Rber2	1.40%	2.01%	1.20%	1.60%	1.79%	2.16%	1.05%	1.84%
TCH/AHS 4.75	FER (dB)	10.5	-	-7.5	-	10.5	-	7.5	-
	Rber1b	0.15%	-	0.18%	-	0.36%	-	0.15%	-
	Rber2	6.00%	-	4.50%	-	5.10%	-	5.20%	-
TCH/WFS 12.65	FER (dB)	13	12	-4	-6.5	14	12.5	9.5	7
	Rber1b	0.32%	0.42%	0.30%	0.35%	0.33%	0.37%	0.27%	0.32%
TCH/WFS 6.60	FER (dB)	9	-	-11	-	8.5	-	4.5	-
	Rber1b	0.15%	-	0.15%	-	0.22%	-	0.15%	-
FACCH/F	FER	10	-	-8.5	-	11	-	6.5	-
FACCH/H	FER	10.5	-	-8.5	-	10.5	-	6	-
SACCH	FER	10	-	-7.5	-	11	-	6.5	-
Repeated SACCH	FER	6	-	-14.5	-	5	-	2.5	-

DCS 1800 & PCS 1900									
VAMOS Test Scenario (see Annex Q)		VUTS-1		VUTS-2		VUTS-3		VUTS-4	
Propagation condition		TU50 noFH		TU50 noFH		TU50 noFH		TU50 noFH	
SCPIR_UL		0 dB	-10 dB	0 dB	-10 dB	0 dB	-10 dB	0 dB	-10 dB
TCH/HS	FER (dB)	11	12	-5.5	-6.5	11.5	12	7.5	7
	Rber1b	0.21%	0.17%	0.18%	0.15%	0.23%	0.18%	0.23%	0.17%
	Rber2	4.64%	4.46%	3.50%	4.01%	4.60%	4.90%	3.86%	4.24%
TCH/EFS	FER (dB)	13.5	13.5	-3.5	-5	14.5	14	10.5	9
	Rber1b	0.04%	0.04%	0.04%	0.04%	0.04%	0.04%	0.04%	0.04%
	Rber2	2.90%	3.87%	3.85%	3.41%	3.10%	3.45%	2.30%	3.27%
TCH/AFS 12.2	FER (dB)	13	13.5	-4.5	-6	14	14	10	8
	Rber1b	0.40%	0.70%	0.52%	0.67%	0.50%	0.70%	0.39%	0.66%
TCH/AFS 4.75	FER (dB)	6	-	-14	-	5.5	-	1	-
	Rber1b	0.14%	-	0.13%	-	0.26%	-	0.15%	-
TCH/AHS 7.4	FER (dB)	15.5	17	-1	0.5	17	17.5	12.5	14
	Rber1b	0.18%	0.29%	0.18%	0.23%	0.18%	0.27%	0.16%	0.18%
	Rber2	1.30%	2.00%	1.54%	1.75%	1.35%	2.02%	1.15%	2.00%
TCH/AHS 4.75	FER (dB)	11.5	-	-7.5	-	10	-	8.5	-
	Rber1b	0.25%	-	0.21%	-	0.37%	-	0.25%	-
	Rber2	6.39%	-	4.40%	-	5.40%	-	6.01%	-

TCH/WFS 12.65	FER (dB)	13.5	13.5	-4	-5	14	14	10.5	9
	Rber1b	0.39%	0.52%	0.32%	0.50%	0.40%	0.54%	0.42%	0.39%
TCH/WFS 6.60	FER (dB)	8.5	-	-11	-	8.5	-	4	-
	Rber1b	0.20%	-	0.15%	-	0.27%	-	0.15%	-
FACCH/F	FER	10	-	-8.5	-	10.5	-	6.5	-
FACCH/H	FER	10.5	-	-8	-	10.5	-	6.5	-
SACCH	FER	12	-	-7	-	10.5	-	8.5	-
Repeated SACCH	FER	6	-	-15	-	5	-	2.5	-

Table 2ad: Cochannel interference ratio (for MS) at reference performance for TIGHTER

GSM 850 and GSM 900						
Type of Channel		Propagation conditions				
		TU3 (no FH)	TU3 (ideal FH)	TU50 (no FH)	TU50 (ideal FH)	RA250 (no FH)
FACCH/H	dB	1,5	-2,5	-2,5	-2,5	1
FACCH/F	dB	2	-3	-2,5	-3	-0,5
SDCCH	dB	2	-2	-1	-2	1,5
TCH/FS	dB	7	0	0	-1	3
	RBER1b (%)	0,05	0,07	0,06	0,08	0,07
	RBER2 (%)	0,6	4,66	4,56	5,67	6,5
TCH/EFS	dB	7	0	1	-0,5	3,5
	RBER1b (%)	0,19	0,09	0,18	0,09	0,03
	RBER2 (%)	0,62	4,86	5,07	4,92	6,01
TCH/HS	dB	7	0,5	1	0	4,5
	RBER1b (%)	0,17	0,23	0,24	0,23	0,17
	RBER2 (%)	0,95	4,45	4,16	4,6	5,19
TCH/AFS12.2	dB	5	-1,5	-2,5	-1,5	2,5
	RBER1b (%)	0,14	0,92	⁽⁶⁾	0,87	1,28
TCH/AFS10.2	dB	4	-3	⁽⁶⁾	-3	1
	RBER1b (%)	0,07	0,18	⁽⁶⁾	0,15	0,24
TCH/AFS7.95	dB	2,5	-5	⁽⁶⁾	-4,5	-2
	RBER1b (%)	0,11	0,35	⁽⁶⁾	0,34	0,46
TCH/AFS7.4	dB	2,5	-5	⁽⁶⁾	-4,5	-2,5
	RBER1b (%)	0,08	0,16	⁽⁶⁾	0,13	0,26
TCH/AFS6.7	dB	2	-5,5	⁽⁶⁾	-5,5	-3,5
	RBER1b (%)	0,16	0,48	⁽⁶⁾	0,49	0,74
TCH/AFS5.9	dB	2	-6	⁽⁶⁾	-6	-4
	RBER1b (%)	0,05	0,15	⁽⁶⁾	0,14	0,21
TCH/AFS5.15	dB	1,5	-6,5	⁽⁶⁾	-6,5	-5
	RBER1b (%)	0,11	0,2	⁽⁶⁾	0,21	0,29
TCH/AFS4.75	dB	1	-7	⁽⁶⁾	-7	-5,5
	RBER1b (%)	0,06	0,12	⁽⁶⁾	0,13	0,15
TCH/AHS7.95	dB	7	2,5	⁽⁶⁾	3	16
	RBER1b (%)	0,12	0,38	⁽⁶⁾	0,28	0,44
	RBER2 (%)	0,39	1,85	⁽⁶⁾	1,8	1,77
TCH/AHS7.4	dB	6,5	2	⁽⁶⁾	2	13,5
	RBER1b (%)	0,08	0,21	⁽⁶⁾	0,21	0,17
	RBER2 (%)	0,45	2,26	⁽⁶⁾	2,31	2,35
TCH/AHS6.7	dB	5,5	1	⁽⁶⁾	1	9,5
	RBER1b (%)	0,09	0,19	⁽⁶⁾	0,19	0,24
	RBER2 (%)	0,7	2,8	⁽⁶⁾	2,7	3,5
TCH/AHS5.9	dB	5	0	⁽⁶⁾	0	7
	RBER1b (%)	0,07	0,11	⁽⁶⁾	0,15	0,16
	RBER2 (%)	0,73	3,6	⁽⁶⁾	3,4	3,93
TCH/AHS5.15	dB	4,5	-1	⁽⁶⁾	-1,5	4
	RBER1b (%)	0,06	0,18	⁽⁶⁾	0,26	0,28
	RBER2 (%)	0,9	4,4	⁽⁶⁾	5,23	5,54
TCH/AHS4.75	dB	3,5	-2	⁽⁶⁾	-2	3
	RBER1b (%)	0,08	0,1	⁽⁶⁾	0,15	0,13
	RBER2 (%)	1,21	5,4	⁽⁶⁾	5,6	6,38
TCH/WFS12.65	dB	14,5	⁽²⁾	8,5	⁽²⁾	12,5
	RBER1b (%)	0,08	⁽²⁾	0,40	⁽²⁾	0,63
TCH/ WFS8.85	dB	13	⁽²⁾	5,5	⁽²⁾	9
	RBER1b (%)	0,11	⁽²⁾	0,42	⁽²⁾	0,73
TCH/ WFS6.60	dB	12	⁽²⁾	4,5	⁽²⁾	8
	RBER1b (%)	0,09	⁽²⁾	0,16	⁽²⁾	0,24

PDTCH/CS-1	dB	9	5,5	6,5	5,5	6,5
PDTCH/CS-2	dB	11	9,5	10,5	9,5	10,5
PDTCH/CS-3	dB	12	11,5	12,5	11,5	13,5
PDTCH/CS-4	dB	17	19,5	20,5	20,5	-
PDTCH/MCS-1	dB	9	5,5	6,5	5,5	8
PDTCH/MCS-2	dB	11	8	8,5	8	10
PDTCH/MCS-3	dB	12,5	12,5	13	13	17
PDTCH/MCS-4	dB	15	17,5	18	18	-
PDTCH/MCS-5	dB	15,5	10,5	12	11	13,5
PDTCH/MCS-6	dB	17,5	13	14,5	14	18
PDTCH/MCS-7	dB	22,5	19,5	21,5	21	-
PDTCH/MCS-8	dB	26,5	19,5**	22**	22**	-
PDTCH/MCS-9	dB	21,5**	24**	27**	27**	-
PDTCH/DAS-5	dB	[14,5]	⁽²⁾	[12]	[11,5]	[12,5] ⁽⁷⁾
PDTCH/DAS-6	dB	[16]	⁽²⁾	[13]	[12]	[14,5] ⁽⁷⁾
PDTCH/DAS-7	dB	[17,5]	⁽²⁾	[14]	[13,5]	[16,5] ⁽⁷⁾
PDTCH/DAS-8	dB	[19,5]	⁽²⁾	[16]	[15,5]	[17,5]
PDTCH/DAS-9	dB	[21,5]	⁽²⁾	[19]	[19]	[22,5]
PDTCH/DAS-10	dB	[25]	⁽²⁾	[22]	[22]	[22,5**]
PDTCH/DAS-11	dB	[27,5]	⁽²⁾	[27,5]	[27,5]	-
PDTCH/DAS-12	dB	[31,5]	⁽²⁾	[29**]	[29**]	-
PDTCH/DBS-5	dB	[14]	⁽²⁾	[11,5]	[10]	[12] ⁽⁷⁾
PDTCH/DBS-6	dB	[16]	⁽²⁾	[14]	[15,5]	[15] ⁽⁷⁾
PDTCH/DBS-7	dB	[19]	⁽²⁾	[15]	[15]	[16]
PDTCH/DBS-8	dB	[22]	⁽²⁾	[18]	[18,5]	[21]
PDTCH/DBS-9	dB	[23,5]	⁽²⁾	[21]	[21]	[24]
PDTCH/DBS-10	dB	[31] ⁽⁷⁾	⁽²⁾	[26]	[28,5]	-
PDTCH/DBS-11	dB	[34] ⁽⁷⁾	⁽²⁾	[25**]	[25**]	-
PDTCH/DBS-12	dB	[27**] ⁽⁷⁾	⁽²⁾	[28,5**]	[29**]	-
(continued)						

Table 2ad (continued): Cochannel interference ratio (for MS) at reference performance for TIGHTER

Type of Channel		DCS 1 800 and PCS 1900				
		Propagation conditions				
		TU1,5 (no FH)	TU1,5 (ideal FH)	TU50 (no FH)	TU50 (ideal FH)	RA130 (no FH)
FACCH/H	dB	1,5	-2,5	-2	-2	1
FACCH/F	dB	2	-3	-2,5	-2,5	-0,5
SDCCH	dB	2	-2	-1,5	-1,5	1,5
TCH/FS	dB	7	0	0	0	3
	RBER1b (%)	0,05	0,07	0,06	0,07	0,06
	RBER2 (%)	0,6	4,66	3,8	4,34	6,49
TCH/EFS	dB	7	0	0	0,5	3
	RBER1b (%)	0,19	0,09	0,08	0,09	0,03
	RBER2 (%)	0,62	4,86	4,02	4,54	6,21
TCH/HS	dB	7	0,5	1	1	5
	RBER1b (%)	0,17	0,23	0,24	0,24	0,16
	RBER2 (%)	0,95	4,45	4,08	4,35	5,13
TCH/AFS12.2	dB	5	-1,5	⁽⁶⁾	-1,5	2,5
	RBER1b (%)	0,14	0,92	⁽⁶⁾	0,88	1,28
TCH/AFS10.2	dB	4	-3	⁽⁶⁾	-3	1
	RBER1b (%)	0,07	0,15	⁽⁶⁾	0,26	0,26
TCH/AFS7.95	dB	3	-5	⁽⁶⁾	-4,5	-2
	RBER1b (%)	0,1	0,35	⁽⁶⁾	0,34	0,46
TCH/AFS7.4	dB	2,5	-5	⁽⁶⁾	-4,5	-2,5
	RBER1b (%)	0,07	0,16	⁽⁶⁾	0,14	0,24
TCH/AFS6.7	dB	2	-5,5	⁽⁶⁾	-5,5	-3,5
	RBER1b (%)	0,15	0,48	⁽⁶⁾	0,51	0,75
TCH/AFS5.9	dB	2	-6	⁽⁶⁾	-6	-4
	RBER1b (%)	0,07	0,15	⁽⁶⁾	0,14	0,2
TCH/AFS5.15	dB	1,5	-6,5	⁽⁶⁾	-6,5	-5
	RBER1b (%)	0,1	0,2	⁽⁶⁾	0,2	0,28
TCH/AFS4.75	dB	1	-7	⁽⁶⁾	-7	-5,5
	RBER1b (%)	0,06	0,12	⁽⁶⁾	0,14	0,15
TCH/AHS7.95	dB	7	2,5	⁽⁶⁾	3	16,5
	RBER1b (%)	0,12	0,38	⁽⁶⁾	0,41	0,42
	RBER2 (%)	0,39	1,85	⁽⁶⁾	1,96	1,74
TCH/AHS7.4	dB	6,5	2	⁽⁶⁾	2,5	14,5
	RBER1b (%)	0,08	0,2	⁽⁶⁾	0,2	0,16
	RBER2 (%)	0,5	2,26	⁽⁶⁾	2,34	2,27
TCH/AHS6.7	dB	5,5	1	⁽⁶⁾	1	9,5
	RBER1b (%)	0,1	0,19	⁽⁶⁾	0,29	0,23
	RBER2 (%)	0,8	2,58	⁽⁶⁾	3,4	3,53
TCH/AHS5.9	dB	5	0	⁽⁶⁾	0	7
	RBER1b (%)	0,07	0,11	⁽⁶⁾	0,14	0,15
	RBER2 (%)	0,8	3,25	⁽⁶⁾	3,92	3,9
TCH/AHS5.15	dB	4,5	-1	⁽⁶⁾	-1	4
	RBER1b (%)	0,06	0,18	⁽⁶⁾	0,26	0,27
	RBER2 (%)	1,0	4,29	⁽⁶⁾	5,28	5,61
TCH/AHS4.75	dB	3,5	-2	⁽⁶⁾	-2	3
	RBER1b (%)	0,08	0,1	⁽⁶⁾	0,16	0,13
	RBER2 (%)	1,3	5,5	⁽⁶⁾	6,31	6,4
TCH/WFS12.65	dB	⁽²⁾	⁽²⁾	7	⁽²⁾	⁽²⁾
	RBER1b (%)	⁽²⁾	⁽²⁾	0,63	⁽²⁾	⁽²⁾
TCH/ WFS8.85	dB	⁽²⁾	⁽²⁾	4	⁽²⁾	⁽²⁾
	RBER1b (%)	⁽²⁾	⁽²⁾	0,64	⁽²⁾	⁽²⁾
TCH/ WFS6.60	dB	⁽²⁾	⁽²⁾	3	⁽²⁾	⁽²⁾
	RBER1b (%)	⁽²⁾	⁽²⁾	0,27	⁽²⁾	⁽²⁾

PDTCH/CS-1	dB	9	5,5	5,5	5,5	6,5
PDTCH/CS-2	dB	11	9,5	9,5	9,5	10,5
PDTCH/CS-3	dB	12	11,5	12,5	12,5	13,5
PDTCH/CS-4	dB	17	19,5	23,5	23,5	-
PDTCH/MCS-1	dB	10	6,5	7,5	6	8
PDTCH/MCS-2	dB	12	9	9,5	8,5	10
PDTCH/MCS-3	dB	13,5	13,5	14	13,5	17
PDTCH/MCS-4	dB	16	18,5	19	18,5	-
PDTCH/MCS-5	dB	16	11	11,5	11,5	13,5
PDTCH/MCS-6	dB	18	13,5	14,5	14,5	18
PDTCH/MCS-7	dB	23	20	24	24	-
PDTCH/MCS-8	dB	27	20**	26**	25**	-
PDTCH/MCS-9	dB	22**	24,5**	-	-	-
PDTCH/DAS-5	dB	(2)	(2)	[11,5]	(2)	(2)
PDTCH/DAS-6	dB	(2)	(2)	[12,5]	(2)	(2)
PDTCH/DAS-7	dB	(2)	(2)	[14]	(2)	(2)
PDTCH/DAS-8	dB	(2)	(2)	[16]	(2)	(2)
PDTCH/DAS-9	dB	(2)	(2)	[20]	(2)	(2)
PDTCH/DAS-10	dB	(2)	(2)	[22,5]	(2)	(2)
PDTCH/DAS-11	dB	(2)	(2)	[27,5**]	(2)	(2)
PDTCH/DAS-12	dB	(2)	(2)	-	(2)	(2)
PDTCH/DBS-5	dB	(2)	(2)	[12] ⁽⁷⁾	(2)	(2)
PDTCH/DBS-6	dB	(2)	(2)	[15,5] ⁽⁷⁾	(2)	(2)
PDTCH/DBS-7	dB	(2)	(2)	[15,5]	(2)	(2)
PDTCH/DBS-8	dB	(2)	(2)	[19,5]	(2)	(2)
PDTCH/DBS-9	dB	(2)	(2)	[18,5**]	(2)	(2)
PDTCH/DBS-10	dB	(2)	(2)	[23**]	(2)	(2)
PDTCH/DBS-11	dB	(2)	(2)	-	(2)	(2)
PDTCH/DBS-12	dB	(2)	(2)	-	(2)	(2)

Performance is specified at 30% BLER for those cases identified with mark "**"

NOTE 1: The specification for SDCCH applies also for BCCH, AGCH, PCH, SACCH. The actual performance of SACCH, particularly for the C/I TU3 (no FH) and TU 1.5 (no FH) cases should be better.

NOTE 2: The requirements for the DCS 1800 & PCS 1900 TU1.5 (no FH) propagation condition are the same as for the GSM 850 & GSM 900 TU3 (no FH) propagation condition, the requirements for the GSM 850 & GSM 900 TU3 (ideal FH), DCS 1800 & PCS 1900 TU1.5 (ideal FH) and DCS 1800 & PCS 1900 TU50 (ideal FH) propagation conditions are the same as for the DCS 1800 & PCS 1900 TU50 (no FH) propagation condition, and the requirements for the DCS 1800 & PCS 1900 RA130 (no FH) propagation condition are the same as for the GSM 850 & GSM 900 RA250 (no FH) propagation condition.

NOTE 3: Ideal FH case assumes perfect decorrelation between bursts. This case may only be tested if such a decorrelation is ensured in the test. For TU50 (ideal FH), sufficient decorrelation may be achieved with 4 frequencies spaced over 5 MHz.

NOTE 4: FER for CCHs takes into account frames which are signalled as being erroneous (by the FIRE code, parity bits, or other means) or where the stealing flags are wrongly interpreted.

NOTE 5: PDTCH/CS-4, PDTCH/MCS-x, PDTCH/DAS-x and PDTCH/DBS-x cannot meet the reference performance for some propagation conditions (-).

NOTE 6: The TU50 no FH TIGHTER requirement for these TCH are specified as a fixed tightening of the reference interference performance listed in Table 2 by 10 dB for GSM 850 & 900 and by 9,5 dB for DCS 1800 and PCS 1900.

NOTE 7: The requirement is identical to the EGPRS2-A or EGPRS2-B requirement in Table 2s or Table 2u, respectively.

Table 2ae: C/I1 ratio at reference performance for TIGHTER

		GSM 900 and GSM 850				
Propagation condition		TU50 no FH				
Type of channel		DARP Test Scenario				
		DTS-1	DTS-2	DTS-3	DTS-4	DTS-5
FACCH/F	dB	-5,5	5,5	7	-	-
SDCCH	dB	-4,5	7	8	-	-
TCH/FS	dB	-4	7,5	8	-2	7
	RBER1b (%)	0,1	0,1	0,1	0,1	0,1
	RBER2 (%)	4,6	4,4	4,3	5,02	4,6
TCH/AFS12.2	dB	-2,5	8	8	-2,5	7,5
	RBER1b (%)	0,6	0,6	0,5	0,8	0,7
TCH/AFS10.2	dB	-4	6,5	7	-	-
	RBER1b (%)	0,2	0,15	0,15	-	-
TCH/AFS7.95	dB	-6	4,5	5,5	-	-
	RBER1b (%)	0,35	0,28	0,28	-	-
TCH/AFS7.4	dB	-6	4,5	5,5	-	-
	RBER1b (%)	0,2	0,15	0,15	-	-
TCH/AFS6.7	dB	-7,5	3,5	5	-	-
	RBER1b (%)	0,5	0,39	0,37	-	-
TCH/AFS5.9	dB	-7,5	3,5	4,5	-8	3
	RBER1b (%)	0,2	0,2	0,15	0,16	0,2
TCH/AFS5.15	dB	-8,5	3	3,5	-	-
	RBER1b (%)	0,21	0,2	0,25	-	-
TCH/AFS4.75	dB	-9	2,5	3	-	-
	RBER1b (%)	0,15	0,15	0,15	-	-
TCH/AHS7.95	dB	1,5	12	12,5	-	-
	RBER1b (%)	0,35	0,3	0,35	-	-
	RBER2 (%)	1,8	1,6	1,43	-	-
TCH/AHS7.4	dB	1	10,5	11,5	-	-
	RBER1b (%)	0,25	0,2	0,2	-	-
	RBER2 (%)	2,2	1,9	1,8	-	-
TCH/AHS6.7	dB	-0,5	9,5	10	-	-
	RBER1b (%)	0,25	0,3	0,25	-	-
	RBER2 (%)	2,9	2,8	2,5	-	-
TCH/AHS5.9	dB	-1,5	8,5	9,5	-	-
	RBER1b (%)	0,15	0,15	0,15	-	-
	RBER2 (%)	3,7	3,5	3,5	-	-
TCH/AHS5.15	dB	-3	7	8	-	-
	RBER1b (%)	0,25	0,3	0,3	-	-
	RBER2 (%)	4,9	4,5	4,8	-	-
TCH/AHS4.75	dB	-4,5	5,5	6,5	-	-
	RBER1b (%)	0,2	0,25	0,2	-	-
	RBER2 (%)	6,5	5,8	5,5	-	-
PDTCH CS-1	dB	-7	6	6,5	-	-
PDTCH CS-2	dB	-4	8,5	9	-	-
PDTCH CS-3	dB	-1,5	11	11,5	-	-
PDTCH CS-4	dB	9,5	20	20,5	-	-
PDTCH MCS-1	dB	-6	7,5	8,5	-	-
PDTCH MCS-2	dB	-4	9	10	-	-
PDTCH MCS-3	dB	1,5	13	13,5	-	-
PDTCH MCS-4	dB	8,5	18	19	-	-

(Continued)

Table 2ae (continued): C/I1 ratio at reference performance for TIGHTER

		DCS 1 800 & PCS 1900				
Propagation condition		TU50 no FH				
Type of channel		DARP Test Scenario				
		DTS-1	DTS-2	DTS-3	DTS-4	DTS-5
FACCH/F	dB	-5,5	5	6	-	-
SDCCH	dB	-4,5	6	7,5	-	-
TCH/FS	dB	-4	7	7	-2,5	7
	RBER1b (%)	0,1	0,1	0,1	0,1	0,1
	RBER2 (%)	5,3	5,7	5,4	6,09	5,8
TCH/AFS12.2	dB	-3,5	7	8	-2,5	7
	RBER1b (%)	0,87	0,89	0,8	0,95	1,1
TCH/AFS10.2	dB	-4,5	5,5	6,5	-	-
	RBER1b (%)	0,2	0,2	0,2	-	-
TCH/AFS7.95	dB	-7	3,5	4,5	-	-
	RBER1b (%)	0,36	0,43	0,4	-	-
TCH/AFS7.4	dB	-7	3,5	4,5	-	-
	RBER1b (%)	0,2	0,2	0,2	-	-
TCH/AFS6.7	dB	-8	2,5	3,5	-	-
	RBER1b (%)	0,7	0,6	0,56	-	-
TCH/AFS5.9	dB	-8,5	2,5	3	-8,5	2
	RBER1b (%)	0,2	0,3	0,16	0,21	0,22
TCH/AFS5.15	dB	-9	1,5	2,5	-	-
	RBER1b (%)	0,25	0,3	0,25	-	-
TCH/AFS4.75	dB	-9,5	1	2	-	-
	RBER1b (%)	0,15	0,2	0,2	-	-
TCH/AHS7.95	dB	2,5	12	13	-	-
	RBER1b (%)	0,35	0,4	0,3	-	-
	RBER2 (%)	1,7	1,8	1,5	-	-
TCH/AHS7.4	dB	1,5	11	12	-	-
	RBER1b (%)	0,2	0,2	0,2	-	-
	RBER2 (%)	2,1	1,9	1,9	-	-
TCH/AHS6.7	dB	0	9,5	10,5	-	-
	RBER1b (%)	0,25	0,25	0,25	-	-
	RBER2 (%)	3,2	2,8	2,5	-	-
TCH/AHS5.9	dB	-1,5	8,5	9,5	-	-
	RBER1b (%)	0,15	0,2	0,2	-	-
	RBER2 (%)	3,8	3,4	3,3	-	-
TCH/AHS5.15	dB	-2,5	7	8	-	-
	RBER1b (%)	0,31	0,3	0,3	-	-
	RBER2 (%)	5	4,7	4,4	-	-
TCH/AHS4.75	dB	-4	6	7	-	-
	RBER1b (%)	0,2	0,25	0,2	-	-
	RBER2 (%)	6,7	5,9	5,46	-	-
PDTCH CS-1	dB	-6,5	5	6	-	-
PDTCH CS-2	dB	-3	8,5	9	-	-
PDTCH CS-3	dB	0	10,5	11	-	-
PDTCH CS-4	dB	13	21,5	22	-	-
PDTCH MCS-1	dB	-5,5	7	8	-	-
PDTCH MCS-2	dB	-3,5	9	9,5	-	-
PDTCH MCS-3	dB	2	13	13,5	-	-
PDTCH MCS-4	dB	9	20	20,5	-	-

Table 2af: Adjacent channel interference ratio (for MS) at reference performance for TIGHTER

GSM 850 and GSM 900						
Type of Channel		Propagation conditions				
		TU3 (no FH)	TU3 (ideal FH)	TU50 (no FH)	TU50 (ideal FH)	RA250 (no FH)
FACCH/H	dB	-16	-21	-21	-21	-21
FACCH/F	dB	-15,5	-21,5	-20,5	-21,5	-21,5
SDCCH	dB	-15,5	-20	-19,5	-20	-20
TCH/FS	dB	-11,5	-19,5	-18,5	-19,5	-19,5
	RBER1b (%)	0,06	0,08	0,07	0,08	0,07
	RBER2 (%)	0,6	5,55	4,12	5,55	6,34
TCH/EFS	dB	-11	-19,5	-18	-19	-19
	RBER1b (%)	0,02	0,04	0,03	0,03	0,04
	RBER2 (%)	0,5	5,2	3,88	4,77	5,73
TCH/HS	dB	-12,5	-19	-19	-19	-18,5
	RBER1b (%)	0,14	0,18	0,19	0,16	0,19
	RBER2 (%)	1,01	5,19	5,04	5,08	5,48
TCH/AFS12.2	dB	-11,5	-19,5	⁽⁶⁾	-19,5	-19,5
	RBER1b (%)	0,12	1,02	⁽⁶⁾	1,01	1,15
TCH/AFS10.2	dB	-12,5	-21	⁽⁶⁾	-21	-21
	RBER1b (%)	0,07	0,25	⁽⁶⁾	0,25	0,26
TCH/AFS7.95	dB	-14	-23	⁽⁶⁾	-23	-23
	RBER1b (%)	0,11	0,44	⁽⁶⁾	0,44	0,43
TCH/AFS7.4	dB	-14	-23	⁽⁶⁾	-23	-23
	RBER1b (%)	0,07	0,23	⁽⁶⁾	0,23	0,24
TCH/AFS6.7	dB	-15	-24	⁽⁶⁾	-24	-24
	RBER1b (%)	0,14	0,63	⁽⁶⁾	0,64	0,68
TCH/AFS5.9	dB	-15	-24,5	⁽⁶⁾	-24,5	-24,5
	RBER1b (%)	0,07	0,2	⁽⁶⁾	0,2	0,21
TCH/AFS5.15	dB	-15,5	-25	⁽⁶⁾	-25	-25
	RBER1b (%)	0,09	0,29	⁽⁶⁾	0,28	0,3
TCH/AFS4.75	dB	-16	-25,5	⁽⁶⁾	-25,5	-25,5
	RBER1b (%)	0,07	0,17	⁽⁶⁾	0,16	0,17
TCH/AHS7.95	dB	-9,5	-15	⁽⁶⁾	-14,5	-10
	RBER1b (%)	0,11	0,42	⁽⁶⁾	0,41	0,43
	RBER2 (%)	0,36	1,97	⁽⁶⁾	1,92	1,99
TCH/AHS7.4	dB	-10	-15,5	⁽⁶⁾	-15,5	-12
	RBER1b (%)	0,08	0,22	⁽⁶⁾	0,21	0,2
	RBER2 (%)	0,43	2,29	⁽⁶⁾	2,28	2,54
TCH/AHS6.7	dB	-11	-17	⁽⁶⁾	-17	-15,5
	RBER1b (%)	0,09	0,28	⁽⁶⁾	0,29	0,29
	RBER2 (%)	0,57	3,26	⁽⁶⁾	3,3	3,71
TCH/AHS5.9	dB	-11,5	-18	⁽⁶⁾	-18	-16,5
	RBER1b (%)	0,07	0,17	⁽⁶⁾	0,16	0,17
	RBER2 (%)	0,66	4,02	⁽⁶⁾	4,02	4,21
TCH/AHS5.15	dB	-12,5	-19	⁽⁶⁾	-19	-18,5
	RBER1b (%)	0,12	0,31	⁽⁶⁾	0,3	0,32
	RBER2 (%)	0,91	5,3	⁽⁶⁾	5,34	5,77
TCH/AHS4.75	dB	-13	-20	⁽⁶⁾	-20	-19,5
	RBER1b (%)	0,09	0,16	⁽⁶⁾	0,16	0,16
	RBER2 (%)	1,11	6,26	⁽⁶⁾	6,32	6,69
TCH/WFS12.65	dB	-10,5	⁽²⁾	-17,5	⁽²⁾	-19
	RBER1b (%)	0,08	⁽²⁾	0,40	⁽²⁾	0,63
TCH/ WFS8.85	dB	-12	⁽²⁾	-20,5	⁽²⁾	-22,5
	RBER1b (%)	0,11	⁽²⁾	0,42	⁽²⁾	0,73
TCH/ WFS6.60	dB	-13	⁽²⁾	-21,5	⁽²⁾	-23,5

	RBER1b (%)	0,09	(2)	0,16	(2)	0,24
PDTCH/CS-1	dB	-15	-19	-18	-19	-18
PDTCH/CS-2	dB	-13	-15	-14	-15	-14
PDTCH/CS-3	dB	-12	-13	-12	-13	-11
PDTCH/CS-4	dB	-7	-5	-4	-4	-
PDTCH/MCS-1	dB	[-14	-17,5	-16,5	-18	-17
PDTCH/MCS-2	dB	-12	-14,5	-14,5	-15,5	-15
PDTCH/MCS-3	dB	-10,5	-1,5	-10	-10,5	-8
PDTCH/MCS-4	dB	-8	3,5	-5	-5,5	-
PDTCH/MCS-5	dB	-9	-13,5	-12,5	-13,5	-13,5
PDTCH/MCS-6	dB	-7	-11	-10,5	-11,5	-10
PDTCH/MCS-7	dB	-2,5	-5	-4	-4	-
PDTCH/MCS-8	dB	5	-3**	-2,5**	-2,5**	-
PDTCH/MCS-9	dB	0,5**	-1**	3**	3**	-
PDTCH/DAS-5	dB	[-8,5]	(2)	[-12]	[-13]	[-12]
PDTCH/DAS-6	dB	[-8]	(2)	[-10,5]	[-11,5]	[-10]
PDTCH/DAS-7	dB	[-7]	(2)	[-8,5]	[-9,5]	[-7]
PDTCH/DAS-8	dB	[-2]	(2)	[-5,5]	[-5,5]	[-2]
PDTCH/DAS-9	dB	[-0,5]	(2)	[-2,5]	[-2,5]	[7]
PDTCH/DAS-10	dB	[10,5]	(2)	[7]	[9]	[8,5**]
PDTCH/DAS-11	dB	[13,5]	(2)	[14]	[16,5]	-
PDTCH/DAS-12	dB	[15,5]	(2)	[14,5**]	[14,5**]	-
PDTCH/DBS-5	dB	[-4] ⁽⁷⁾	(2)	[-7] ⁽⁷⁾	[-7,5] ⁽⁷⁾	[-8] ⁽⁷⁾
PDTCH/DBS-6	dB	[-2] ⁽⁷⁾	(2)	[-4] ⁽⁷⁾	[-4,5] ⁽⁷⁾	[-4] ⁽⁷⁾
PDTCH/DBS-7	dB	[5] ⁽⁷⁾	(2)	[1,5] ⁽⁷⁾	[0,5] ⁽⁷⁾	[2] ⁽⁷⁾
PDTCH/DBS-8	dB	[8] ⁽⁷⁾	(2)	[5,5] ⁽⁷⁾	[5] ⁽⁷⁾	[10] ⁽⁷⁾
PDTCH/DBS-9	dB	[10] ⁽⁷⁾	(2)	[8,5] ⁽⁷⁾	[8] ⁽⁷⁾	[20,5] ⁽⁷⁾
PDTCH/DBS-10	dB	[18,5] ⁽⁷⁾	(2)	[17] ⁽⁷⁾	[17,5] ⁽⁷⁾	-
PDTCH/DBS-11	dB	[22,5] ⁽⁷⁾	(2)	[29,5] ⁽⁷⁾	[30] ⁽⁷⁾	-
PDTCH/DBS-12	dB	[27,5] ⁽⁷⁾	(2)	[23**] ⁽⁷⁾	[24**] ⁽⁷⁾	-
(continued)						

Table 2af (continued): Adjacent channel interference ratio (for MS) at reference performance for TIGHTER

DCS 1 800 and PCS 1900						
Type of channel		Propagation conditions				
		TU1,5 (no FH)	TU1,5 (ideal FH)	TU50 (no FH)	TU50 (ideal FH)	RA130 (no FH)
FACCH/H	dB	-15,5	-21	-20,5	-20,5	-20,5
FACCH/F	dB	-15,5	-21,5	-21	-21,5	-21,5
SDCCH	dB	-15,5	-20	-20	-20	-20
TCH/FS	dB	-11,5	-19,5	-19,5	-19,5	-19,5
	RBER1b (%)	0,06	0,08	0,07	0,09	0,08
	RBER2 (%)	0,59	5,59	5,87	5,54	6,34
TCH/EFS	dB	-11	-19,5	-19	-19,5	-19
	RBER1b (%)	0,02	0,04	0,03	0,04	0,04
	RBER2 (%)	0,5	5,19	4,93	5,22	5,76
TCH/HS	dB	-12,5	-19	-18,5	-19	-18,5
	RBER1b (%)	0,13	0,19	0,18	0,18	0,17
	RBER2 (%)	0,97	5,17	5,11	5,18	5,62
TCH/AFS12.2	dB	-11,5	-19,5	⁽⁶⁾	-19,5	-19,5
	RBER1b (%)	0,12	1,01	⁽⁶⁾	1,02	1,14
TCH/AFS10.2	dB	-12,5	-21	⁽⁶⁾	-21	-20,5
	RBER1b (%)	0,07	0,24	⁽⁶⁾	0,25	0,26
TCH/AFS7.95	dB	-14	-23	⁽⁶⁾	-23	-23
	RBER1b (%)	0,11	0,43	⁽⁶⁾	0,43	0,44
TCH/AFS7.4	dB	-14	-23	⁽⁶⁾	-23	-23
	RBER1b (%)	0,07	0,23	⁽⁶⁾	0,23	0,25
TCH/AFS6.7	dB	-15	-24	⁽⁶⁾	-24	-24
	RBER1b (%)	0,14	0,62	⁽⁶⁾	0,66	0,69
TCH/AFS5.9	dB	-15	-24,5	⁽⁶⁾	-24,5	-24,5
	RBER1b (%)	0,08	0,2	⁽⁶⁾	0,2	0,21
TCH/AFS5.15	dB	-15,5	-25	⁽⁶⁾	-25	-25
	RBER1b (%)	0,09	0,29	⁽⁶⁾	0,3	0,3
TCH/AFS4.75	dB	-16	-25,5	⁽⁶⁾	-25,5	-25,5
	RBER1b (%)	0,07	0,17	⁽⁶⁾	0,17	0,17
TCH/AHS7.95	dB	-9,5	-15	⁽⁶⁾	-14,5	-10,5
	RBER1b (%)	0,1	0,43	⁽⁶⁾	0,42	0,47
	RBER2 (%)	0,35	1,99	⁽⁶⁾	1,98	2,06
TCH/AHS7.4	dB	-10	-15,5	⁽⁶⁾	-15,5	-12,5
	RBER1b (%)	0,08	0,21	⁽⁶⁾	0,21	0,21
	RBER2 (%)	0,4	2,29	⁽⁶⁾	2,32	2,58
TCH/AHS6.7	dB	-11	-17	⁽⁶⁾	-17	-15
	RBER1b (%)	0,09	0,28	⁽⁶⁾	0,3	0,28
	RBER2 (%)	0,57	3,29	⁽⁶⁾	3,36	3,73
TCH/AHS5.9	dB	-11,5	-18	⁽⁶⁾	-18	-17
	RBER1b (%)	0,07	0,17	⁽⁶⁾	0,16	0,17
	RBER2 (%)	0,66	4,01	⁽⁶⁾	3,98	4,24
TCH/AHS5.15	dB	-12,5	-19,5	⁽⁶⁾	-19	-18,5
	RBER1b (%)	0,12	0,32	⁽⁶⁾	0,32	0,32
	RBER2 (%)	0,92	5,35	⁽⁶⁾	5,36	5,82
TCH/AHS4.75	dB	-13	-20	⁽⁶⁾	-20	-19,5
	RBER1b (%)	0,09	0,16	⁽⁶⁾	0,16	0,17
	RBER2 (%)	1,1	6,29	⁽⁶⁾	6,38	6,78
TCH/WFS12.65	dB	⁽²⁾	⁽²⁾	-19	⁽²⁾	⁽²⁾
	RBER1b (%)	⁽²⁾	⁽²⁾	0,63	⁽²⁾	⁽²⁾
TCH/ WFS8.85	dB	⁽²⁾	⁽²⁾	-22	⁽²⁾	⁽²⁾
	RBER1b (%)	⁽²⁾	⁽²⁾	0,64	⁽²⁾	⁽²⁾
TCH/ WFS6.60	dB	⁽²⁾	⁽²⁾	-23	⁽²⁾	⁽²⁾

	RBER1b (%)	(2)	(2)	0,27	(2)	(2)
PDTCH/CS-1	dB	-15	-19	-19	-19	-18
PDTCH/CS-2	dB	-13	-15	-15	-15	-14
PDTCH/CS-3	dB	-12	-13	-12	-12	-11
PDTCH/CS-4	dB	-7	-5	-1	-1	-
PDTCH/MCS-1	dB	-14	-17,5	-17	-18	-16
PDTCH/MCS-2	dB	-12	-15	-15	-15,5	-14
PDTCH/MCS-3	dB	-10,5	-10,5	-10	-9,5	-7
PDTCH/MCS-4	dB	-8	-5,5	-4	-4,5	-
PDTCH/MCS-5	dB	-9	-13,5	-13	-13	-13,5
PDTCH/MCS-6	dB	-7	-11	-11	-11	-10
PDTCH/MCS-7	dB	-2,5	-5	-2,5	-2,5	-
PDTCH/MCS-8	dB	5	-3**	0**	0**	-
PDTCH/MCS-9	dB	0**	1,5**	-	-	-
PDTCH/DAS-5	dB	(2)	(2)	[-12,5]	(2)	(2)
PDTCH/DAS-6	dB	(2)	(2)	[-10,5]	(2)	(2)
PDTCH/DAS-7	dB	(2)	(2)	[-8,5]	(2)	(2)
PDTCH/DAS-8	dB	(2)	(2)	[-4]	(2)	(2)
PDTCH/DAS-9	dB	(2)	(2)	[0]	(2)	(2)
PDTCH/DAS-10	dB	(2)	(2)	[8]	(2)	(2)
PDTCH/DAS-11	dB	(2)	(2)	[14**]	(2)	(2)
PDTCH/DAS-12	dB	(2)	(2)	-	(2)	(2)
PDTCH/DBS-5	dB	(2)	(2)	[-7,5] ⁽⁷⁾	(2)	(2)
PDTCH/DBS-6	dB	(2)	(2)	[-4] ⁽⁷⁾	(2)	(2)
PDTCH/DBS-7	dB	(2)	(2)	[1,5] ⁽⁷⁾	(2)	(2)
PDTCH/DBS-8	dB	(2)	(2)	[6] ⁽⁷⁾	(2)	(2)
PDTCH/DBS-9	dB	(2)	(2)	[9,5] ⁽⁷⁾	(2)	(2)
PDTCH/DBS-10	dB	(2)	(2)	[22] ⁽⁷⁾	(2)	(2)
PDTCH/DBS-11	dB	(2)	(2)	[24,5**] ⁽⁷⁾	(2)	(2)
PDTCH/DBS-12	dB	(2)	(2)	-	(2)	(2)

Performance is specified at 30% BLER for those cases identified with mark "**"

NOTE 1: The specification for SDCCH applies also for BCCH, AGCH, PCH, SACCH. The actual performance of SACCH, particularly for the C/I TU3 (no FH) and TU 1.5 (no FH) cases should be better.

NOTE 2: The requirements for the DCS 1800 & PCS 1900 TU1.5 (no FH) propagation condition are the same as for the GSM 850 & GSM 900 TU3 (no FH) propagation condition, the requirements for the GSM 850 & GSM 900 TU3 (ideal FH), DCS 1800 & PCS 1900 TU1.5 (ideal FH) and DCS 1800 & PCS 1900 TU50 (ideal FH) propagation conditions are the same as for the DCS 1800 & PCS 1900 TU50 (no FH) propagation condition, and the requirements for the DCS 1800 & PCS 1900 RA130 (no FH) propagation condition are the same as for the GSM 850 & GSM 900 RA250 (no FH) propagation condition.

NOTE 3: Ideal FH case assumes perfect decorrelation between bursts. This case may only be tested if such a decorrelation is ensured in the test. For TU50 (ideal FH), sufficient decorrelation may be achieved with 4 frequencies spaced over 5 MHz.

NOTE 4: FER for CCHs takes into account frames which are signalled as being erroneous (by the FIRE code, parity bits, or other means) or where the stealing flags are wrongly interpreted.

NOTE 5: PDTCH/CS-4, PDTCH/MCS-x, PDTCH/DAS-x and PDTCH/DBS-x cannot meet the reference performance for some propagation conditions (-).

NOTE 6: The TU50 no FH TIGHTER requirement for these TCH are specified as a fixed tightening of the reference interference performance listed in Table 2 by 10 dB for GSM 850 & 900 and by 9,5 dB for DCS 1800 and PCS 1900 (see section 6.3.1).

NOTE 7: The requirement is identical to the EGPRS2-B requirement in Table 2y.

Annex A (informative): Spectrum characteristics (spectrum due to the modulation)

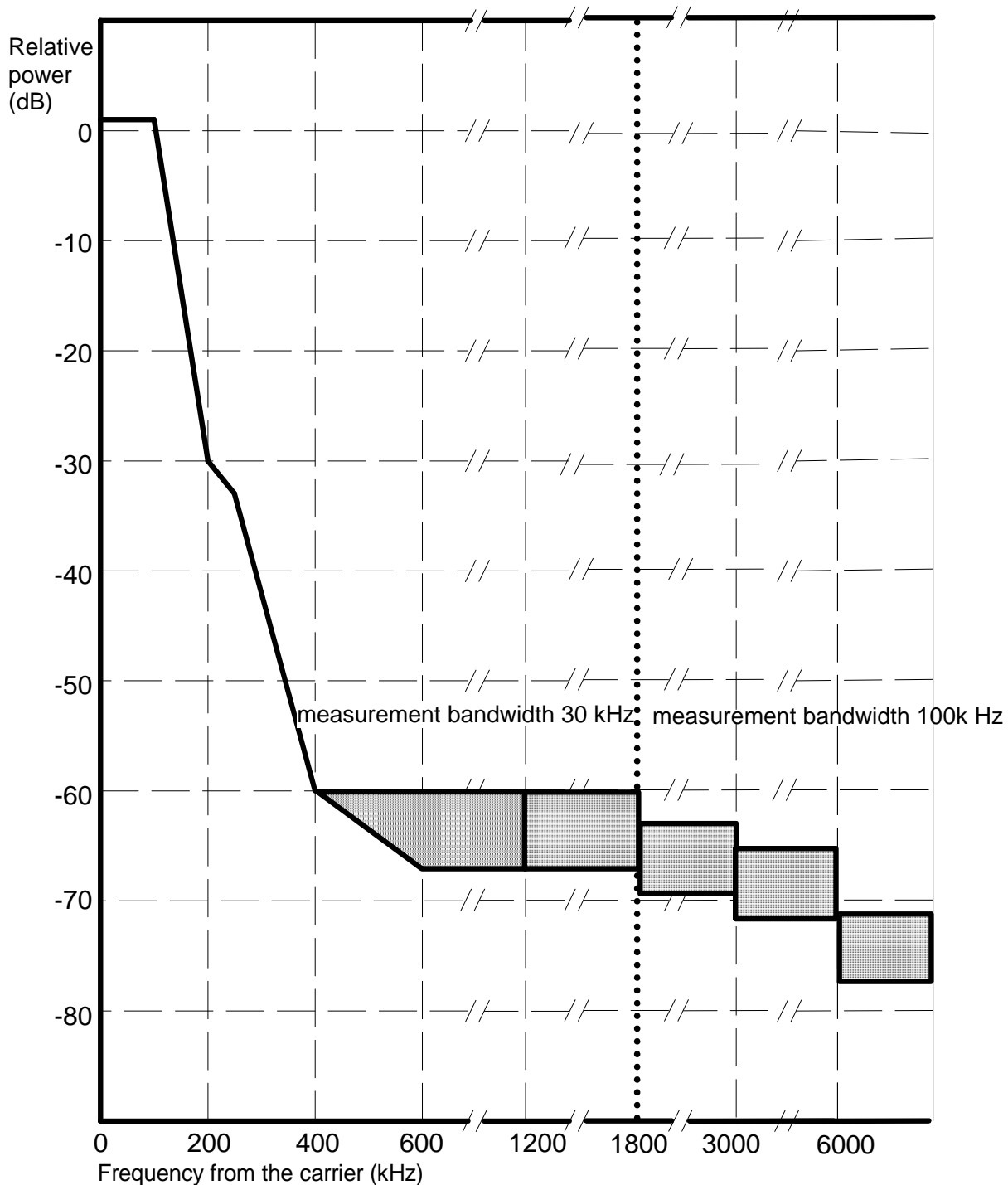

Figure A.1a: GSM 400, GSM 900, GSM 850 and GSM 700 MS spectrum due to GMSK modulation

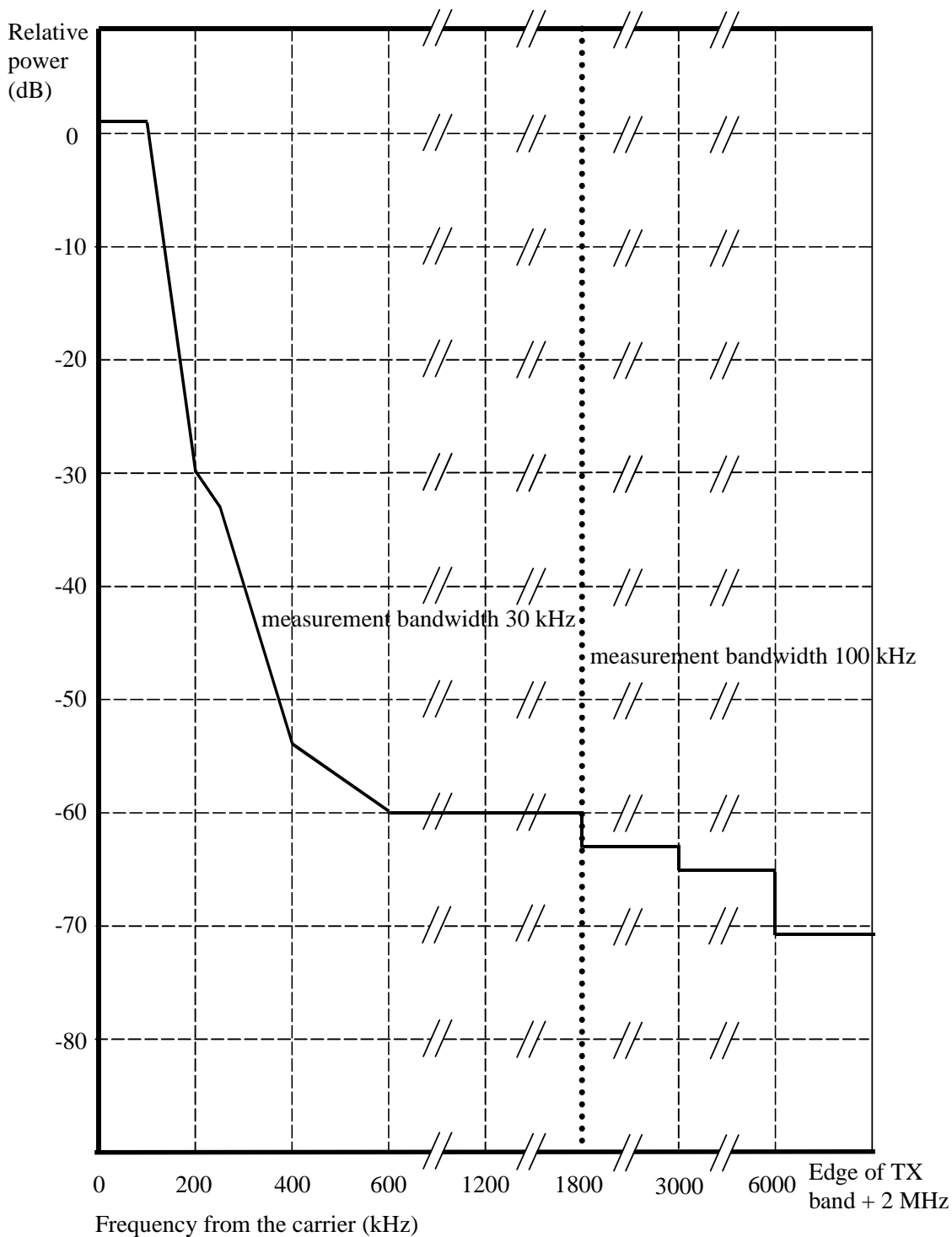

Figure A.1b: GSM 400, GSM 900, GSM 850 and GSM 700 MS spectrum due to 8-PSK and 16-QAM modulation with normal symbol rate and QPSK, 16-QAM and 32-QAM modulation with higher symbol rate using narrow BW pulse shaping filter

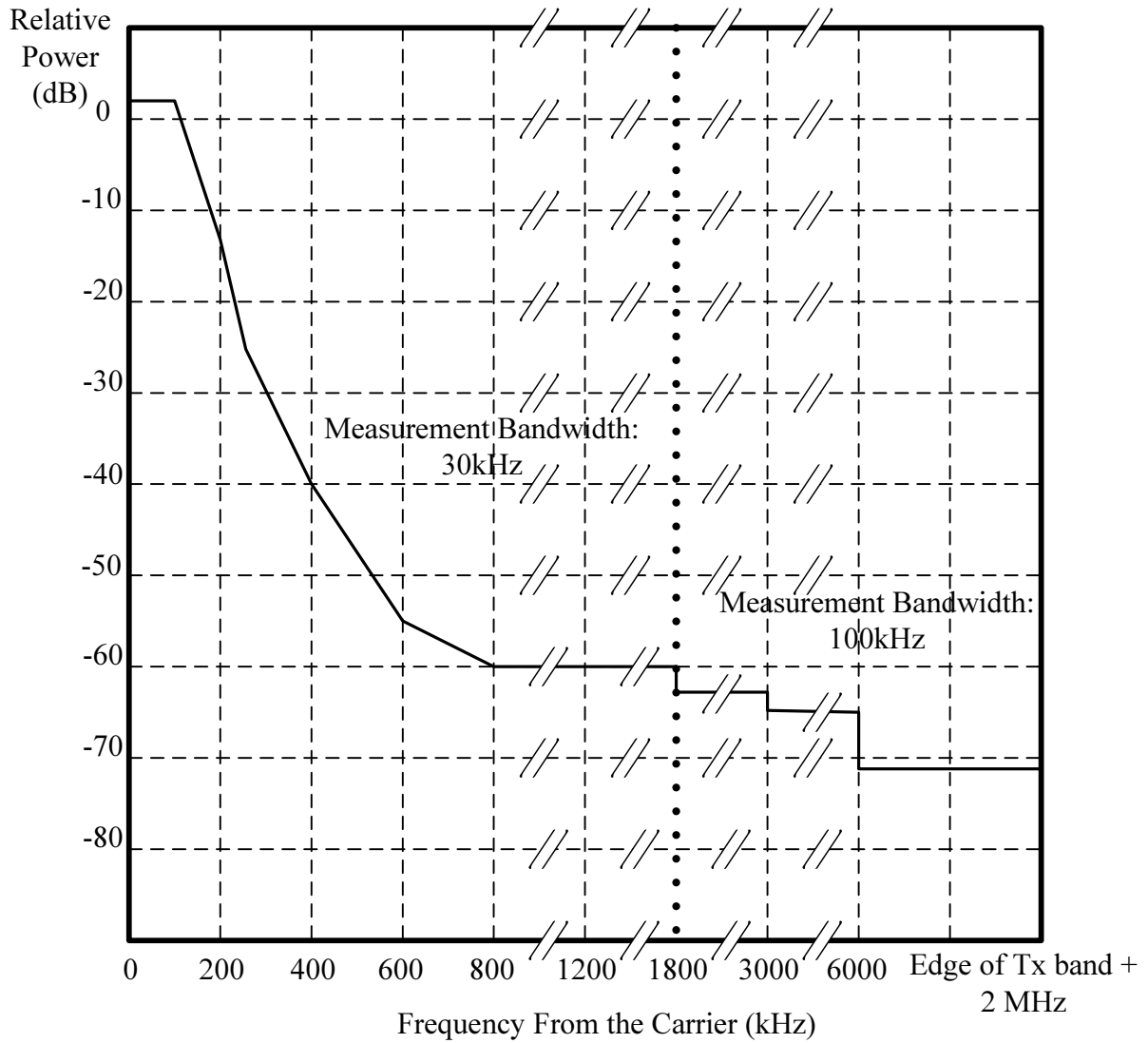

Figure A.1c: GSM 400, GSM 900, GSM 850 and GSM 700 MS spectrum due to QPSK, 16- QAM and 32- QAM modulation with higher symbol rate using wide pulse shaping filter

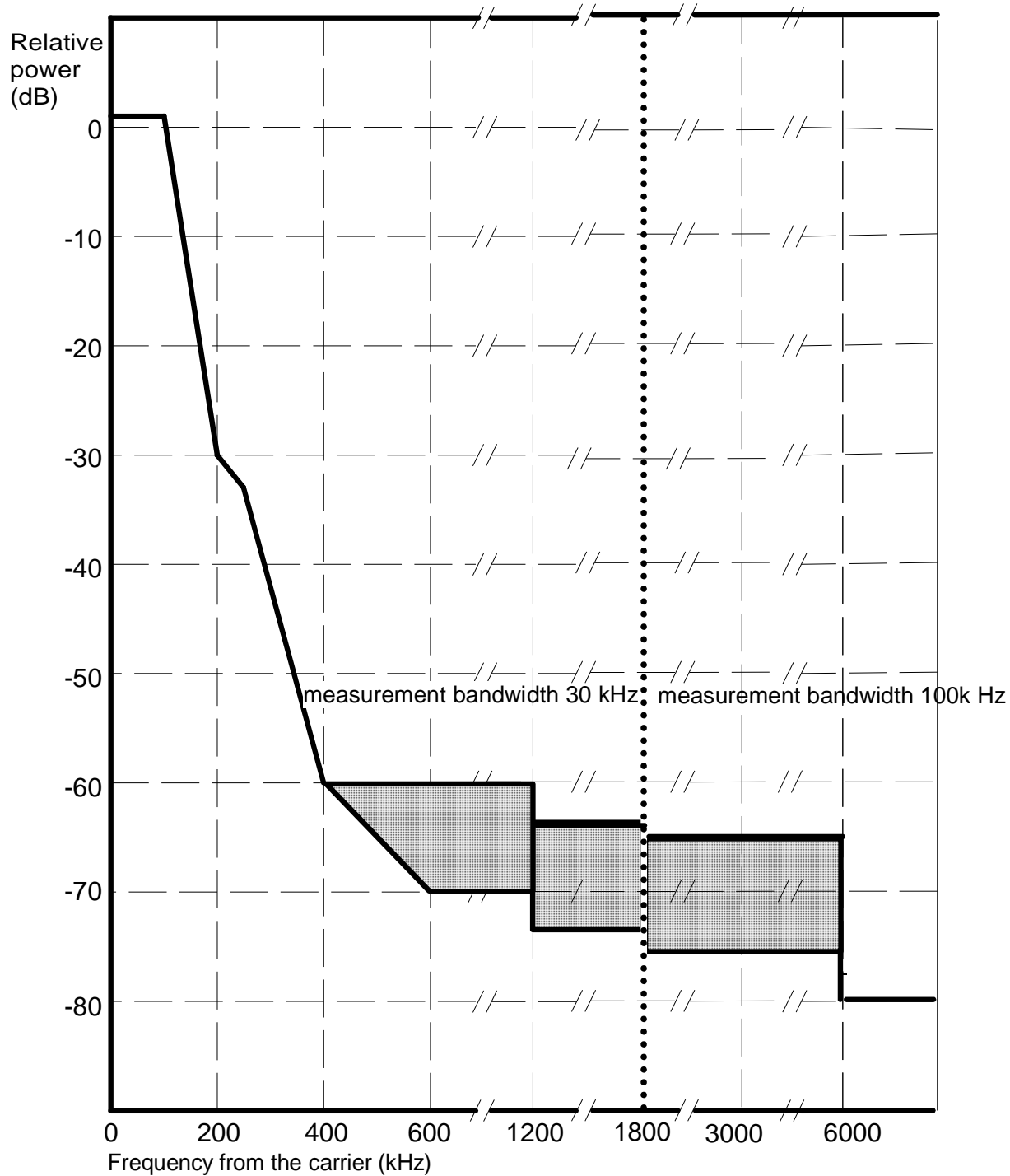

Figure A.2a: GSM 400, GSM 900, GSM 850, MXM 850, GSM 700, DCS 1800, PCS 1900 and MXM 1900 BTS spectrum due to GMSK modulation

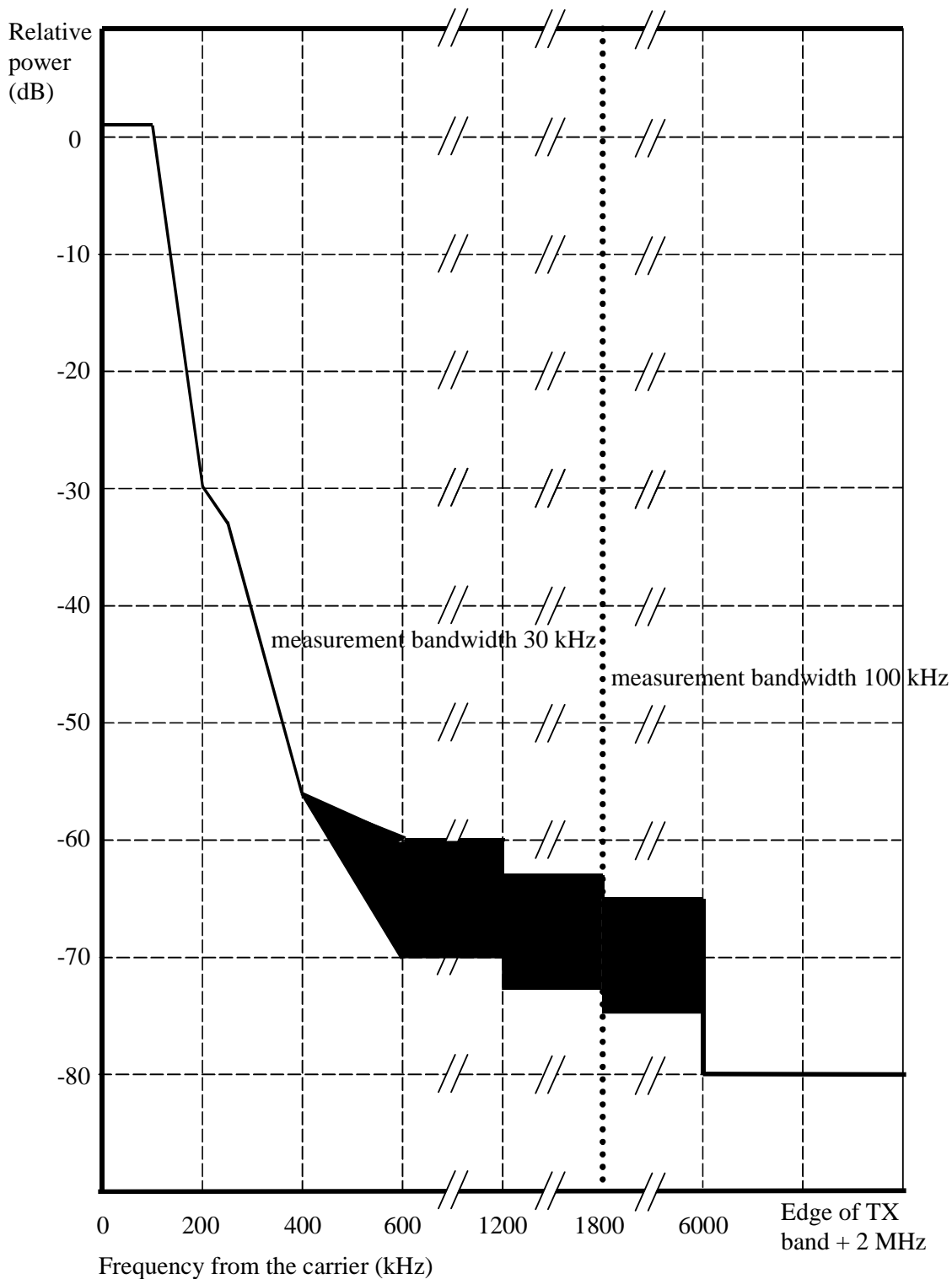

Figure A.2b: GSM 400, GSM 900, GSM 850, MXM 850, GSM 700, DCS 1800, PCS 1900 and MXM 1900 BTS spectrum due to 8-PSK, AQPSK, 16-QAM and 32-QAM modulation with normal symbol rate and QPSK, 16-QAM and 32-QAM modulation with higher symbol rate using narrow BW pulse shaping filter

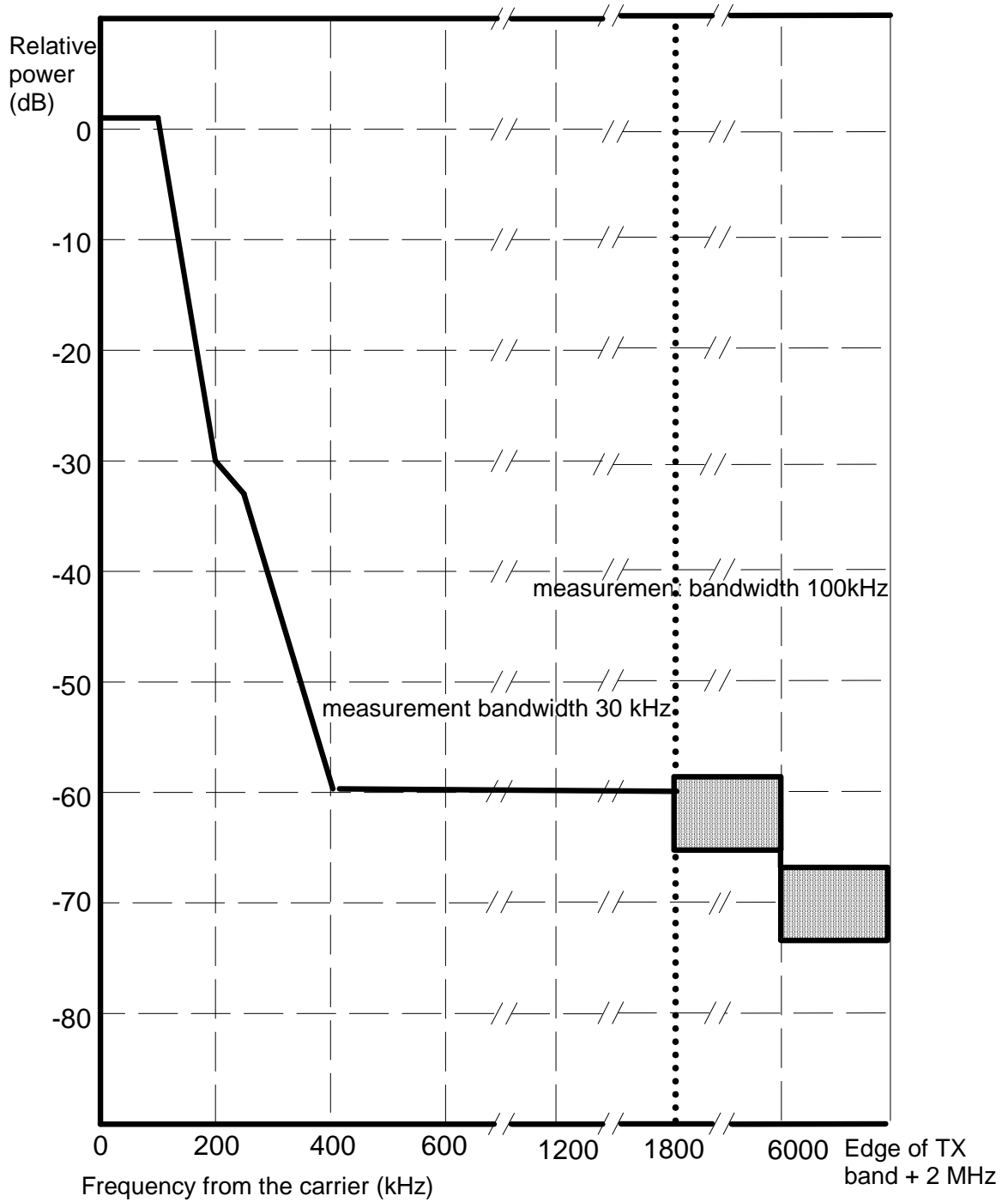

Figure A.3a: DCS 1 800 and PCS 1900 MS spectrum due to GMSK modulation

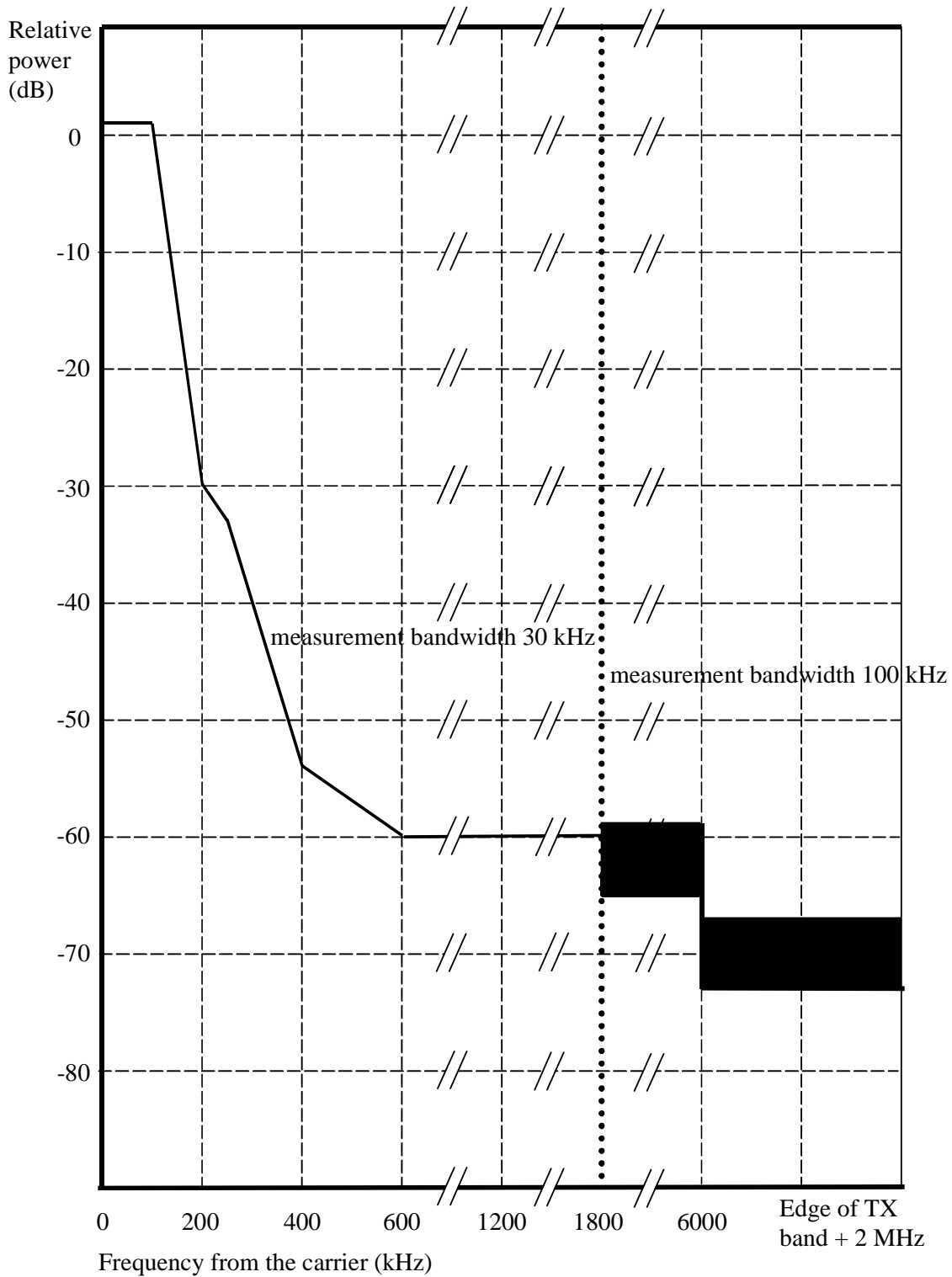

Figure A.3b: DCS 1 800 and PCS 1900 MS spectrum due to 8-PSK and 16-QAM modulation with normal symbol rate and QPSK, 16-QAM and 32-QAM with higher symbol rate modulation using narrow BW pulse shaping filter

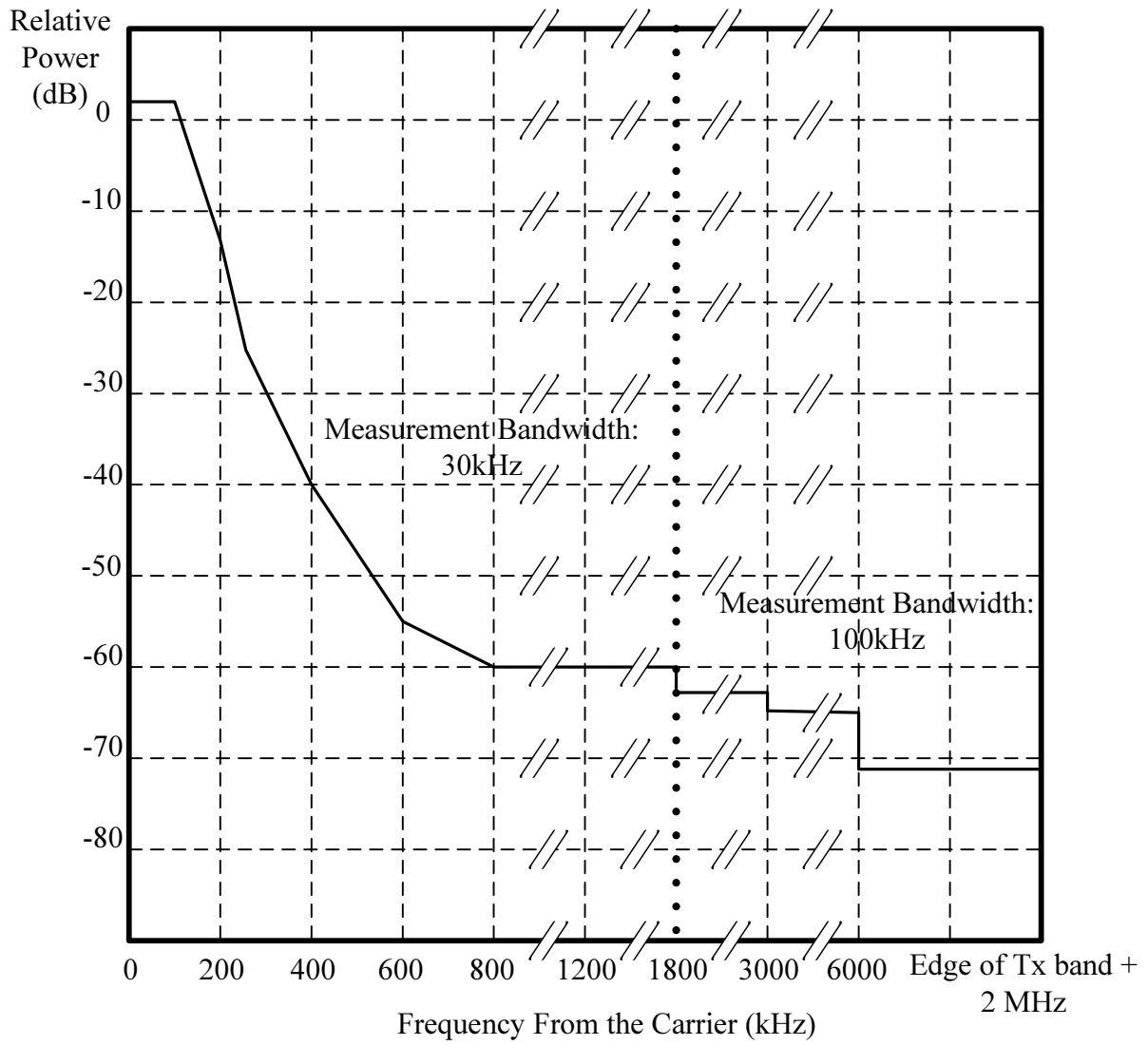

Figure A.3c: DCS 1 800 and PCS 1900 MS spectrum due to QPSK, 16-QAM and 32-QAM modulation with higher symbol rate using using wide pulse shaping filter

Annex B (normative): Transmitted power level versus time

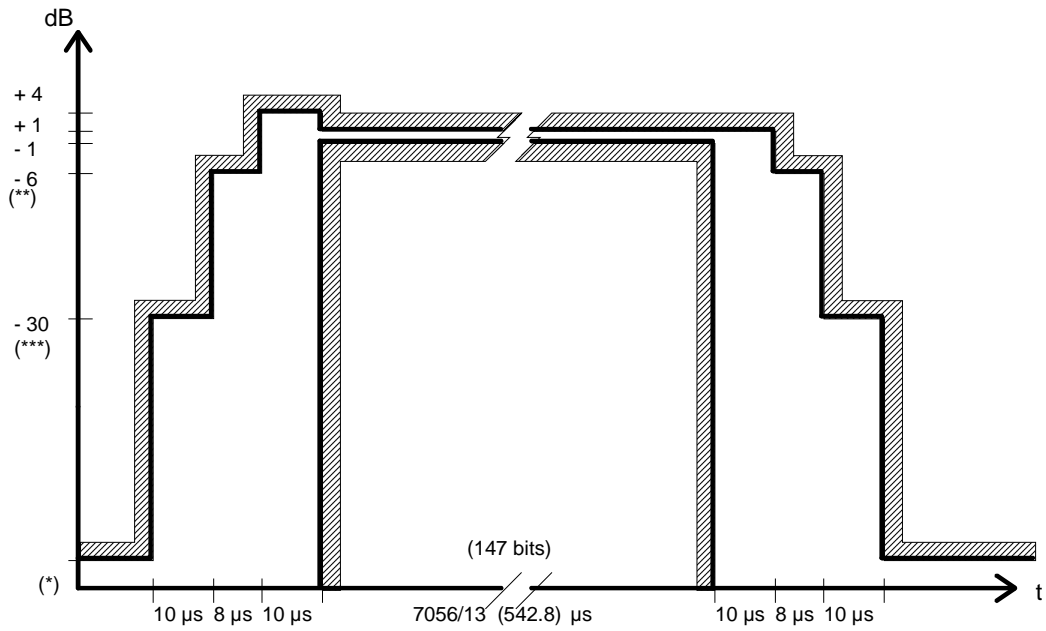

Figure B.1: Time mask for normal duration bursts (NB, FB, dB and SB) at GSM modulation

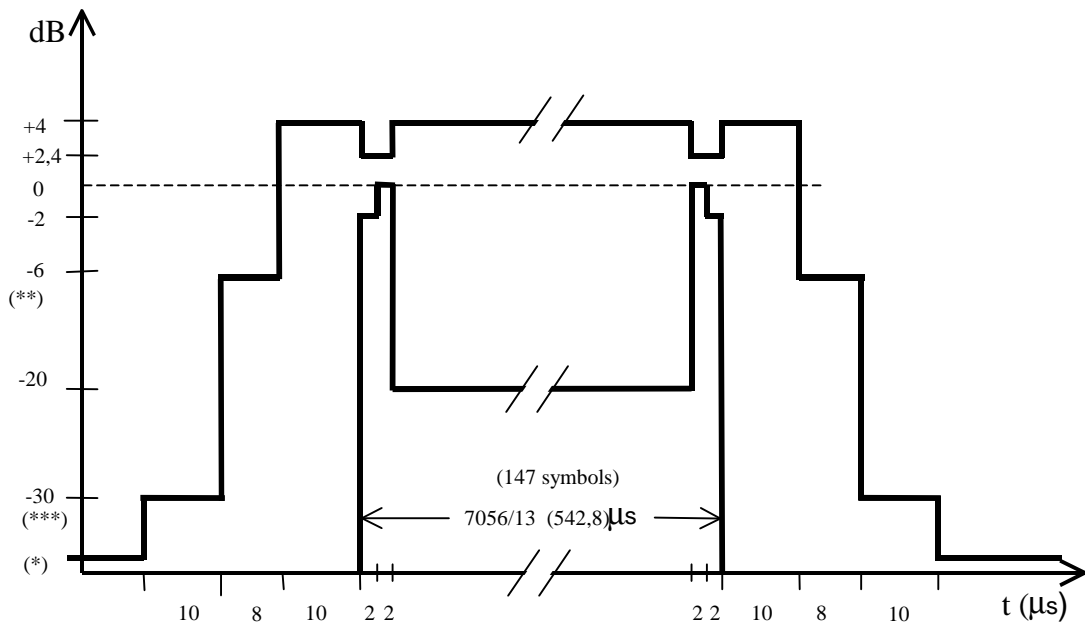

Figure B.2: Time mask for normal duration bursts (NB) at 8-PSK modulation

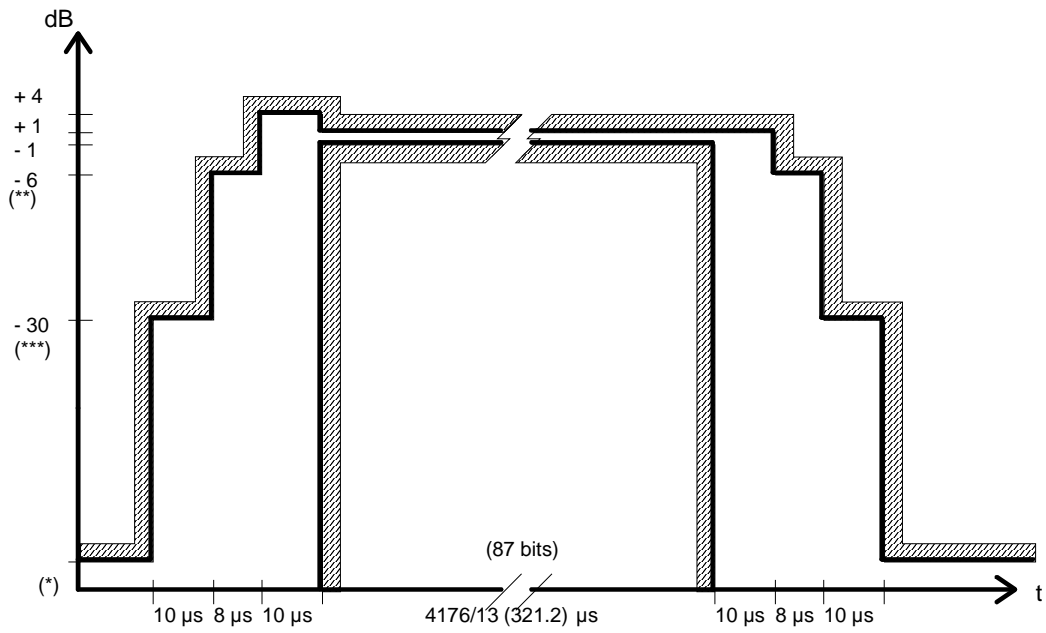
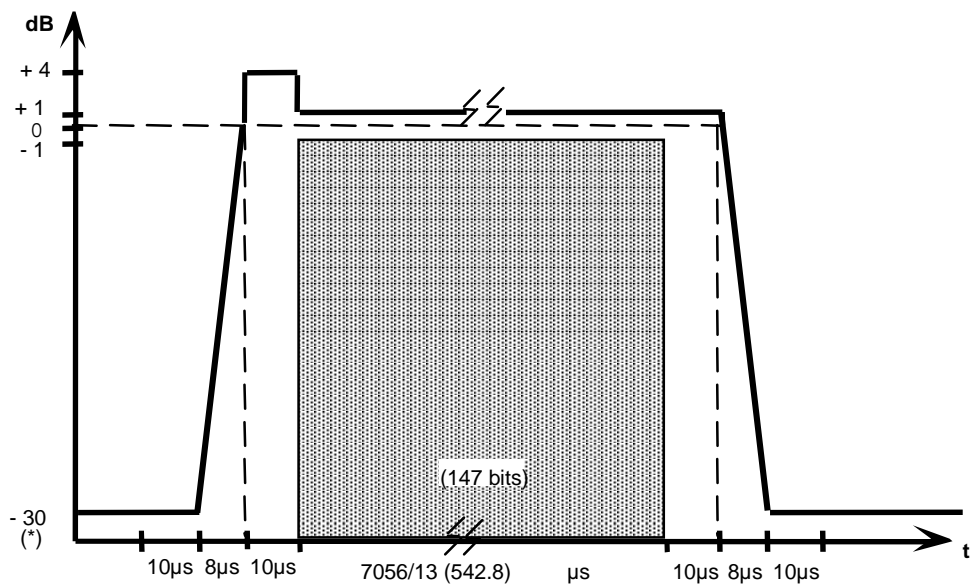

Figure B.3: Time mask for access bursts (AB)



Dashed Lines indicate reference points only

Figure B.4: PCS 1900 and MXM 1900 BTS Transmitter Time Mask at GMSK modulation

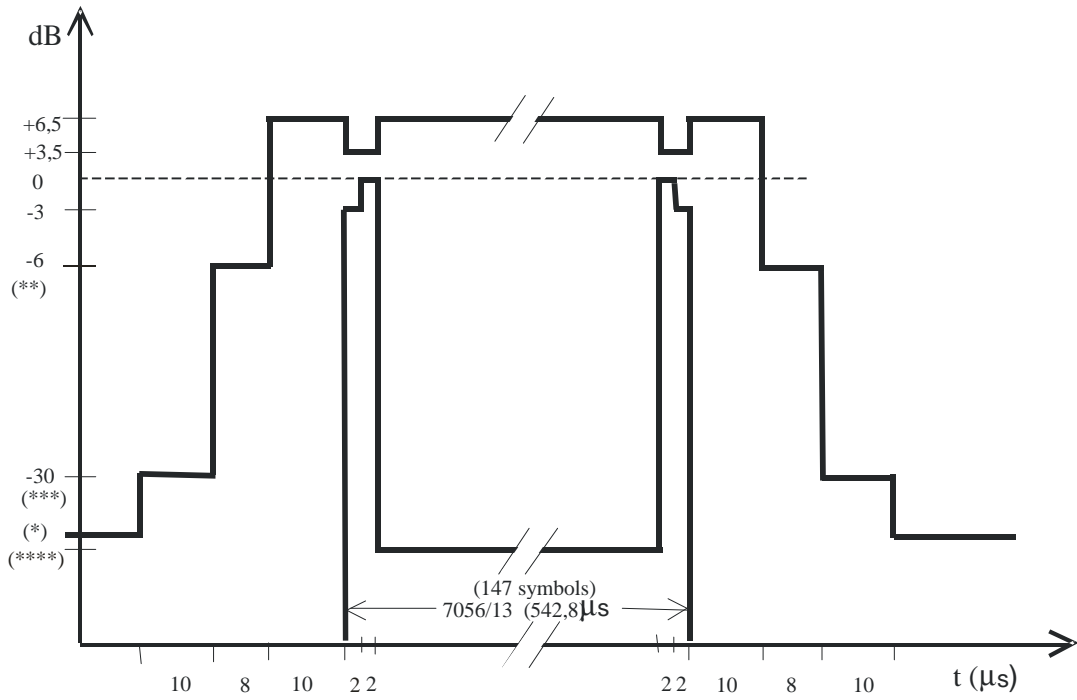

Figure B.5: Time mask for normal duration bursts (NB) at 16-QAM and 32-QAM modulation at normal symbol rate

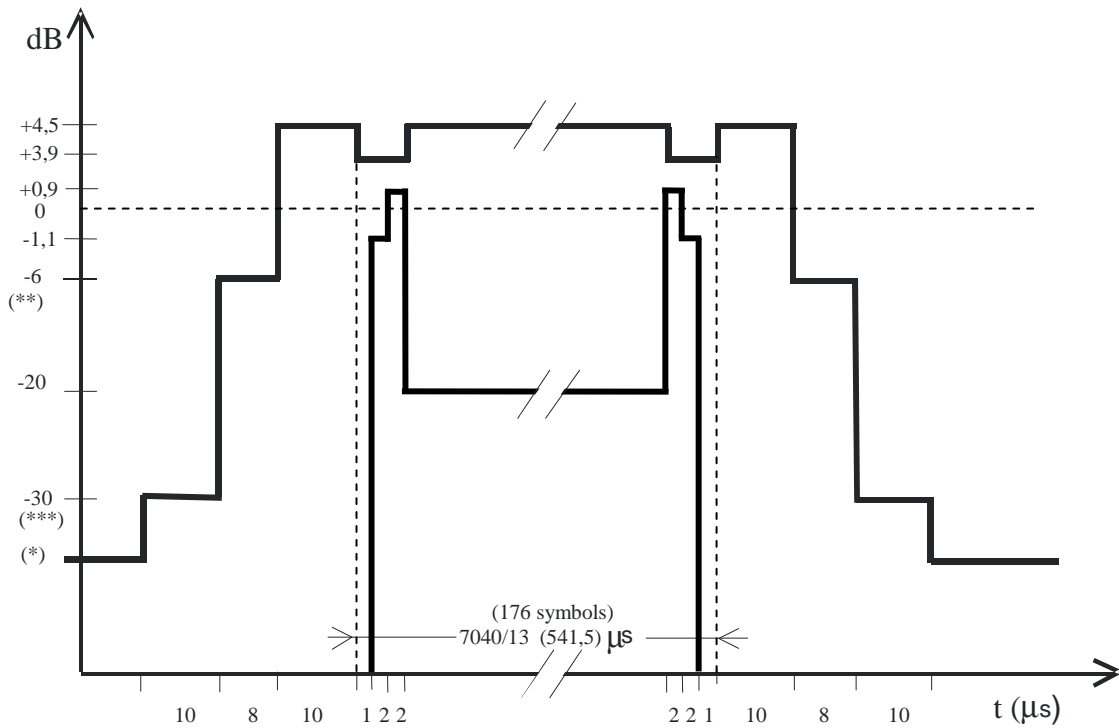
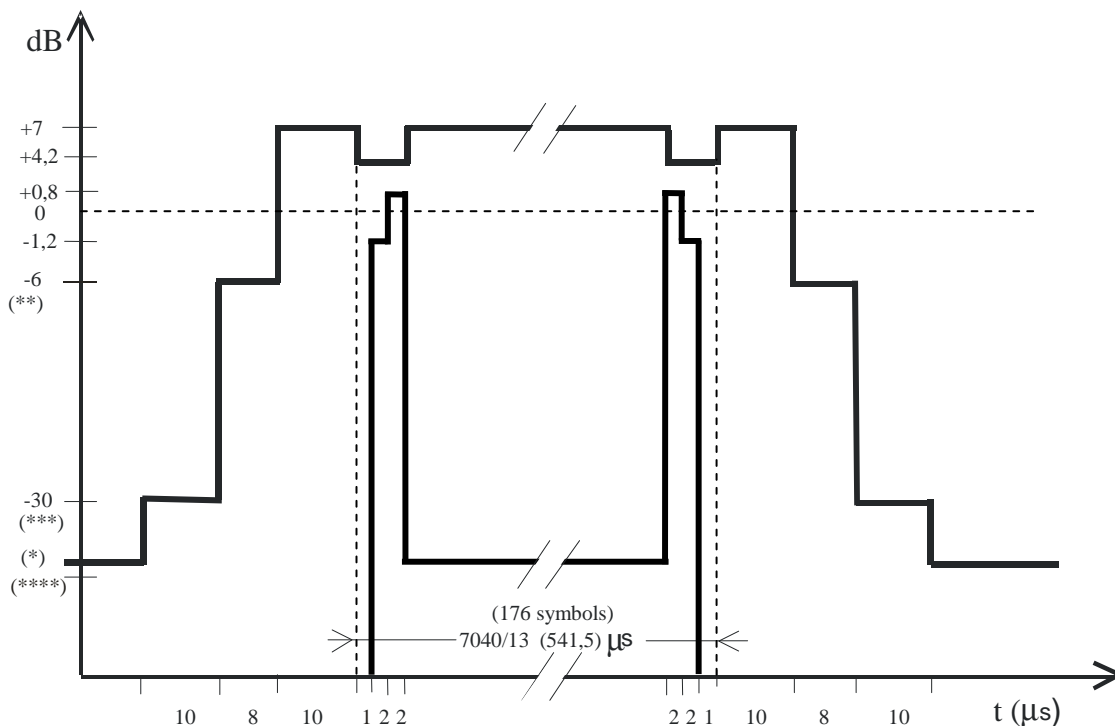

Figure B.6: Time mask for higher symbol rate bursts (HB) at QPSK modulation with narrow pulse shaping filter



B.7: Time mask for higher symbol rate bursts (HB) at 16-QAM and 32-QAM modulation with narrow pulse shaping filter

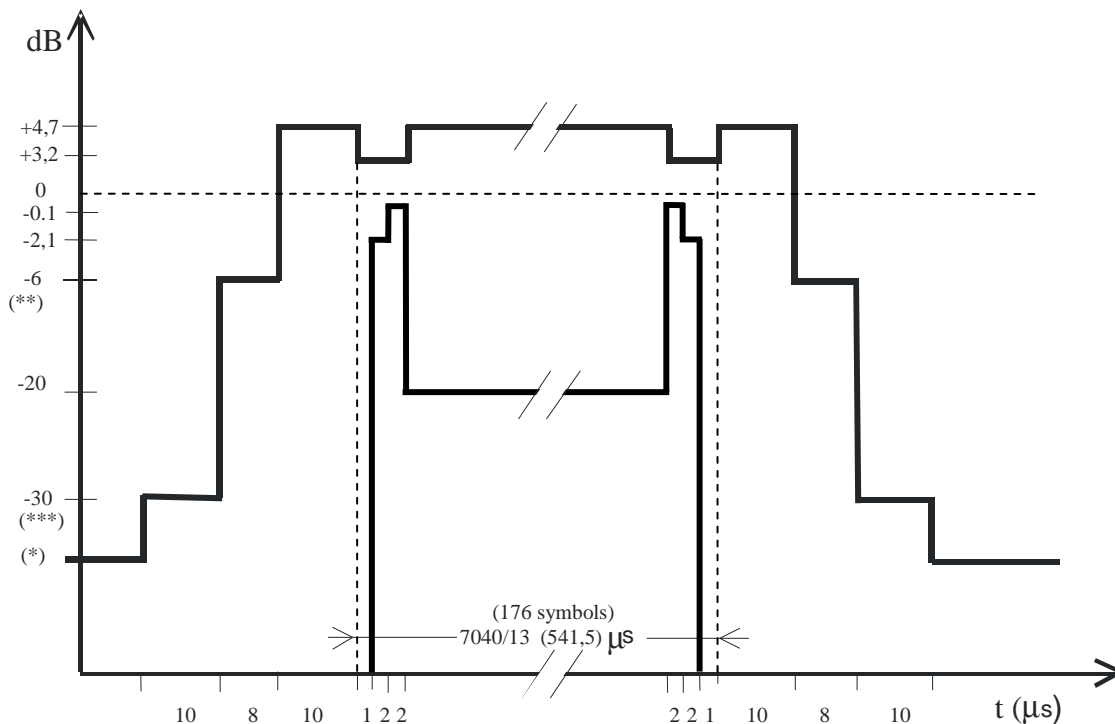

Figure B.8: Time mask for higher symbol rate bursts (HB) at QPSK modulation with wide pulse shaping filter

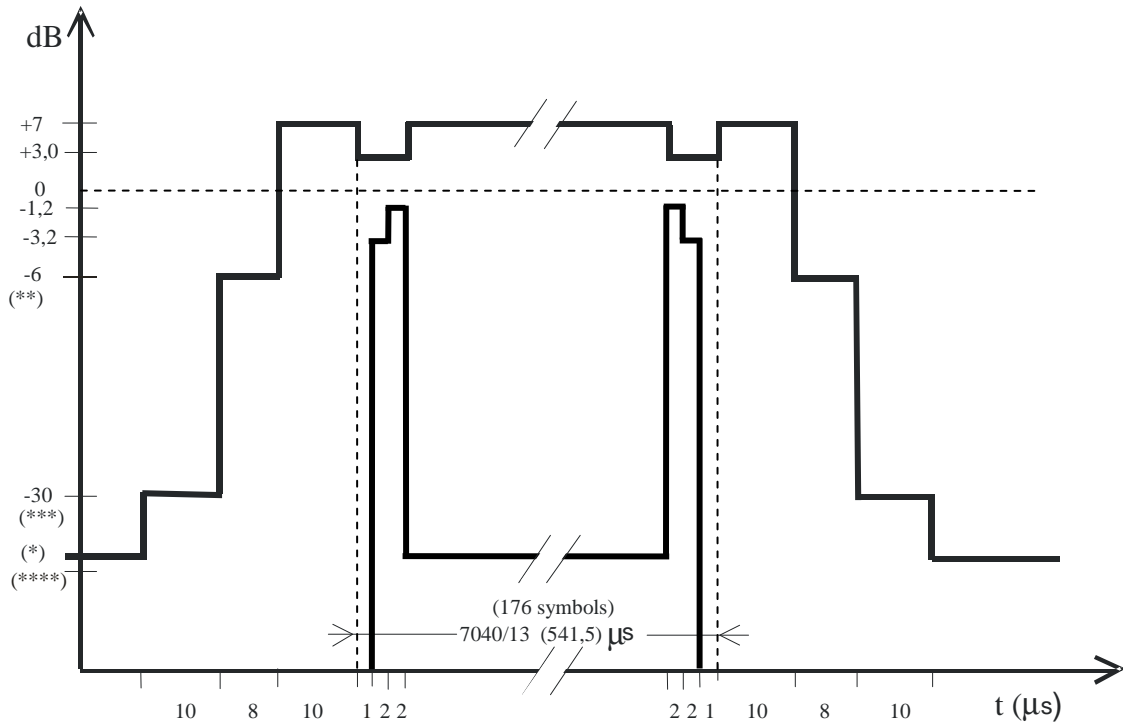

Figure B.9: Time mask for higher symbol rate bursts (HB) at 16-QAM and 32-QAM modulation with wide pulse shaping filter

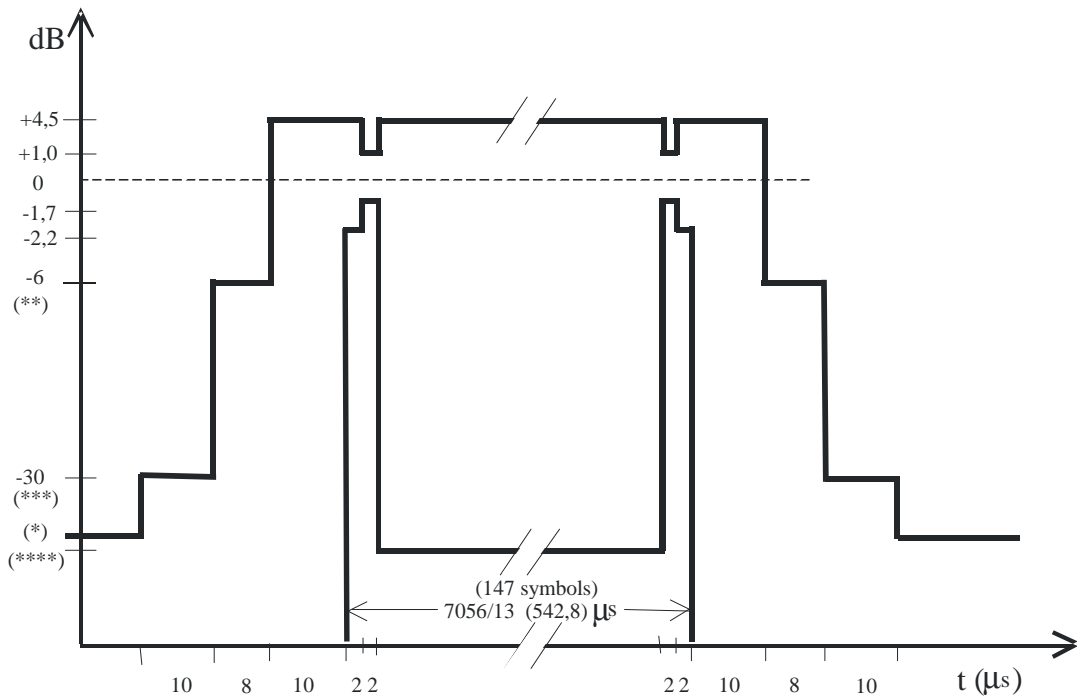

Figure B.10: Time mask for AQPSK modulation (Note: the above time mask is applicable to all values of α (see 3GPP TS 45.004) supported by the BTS)

- (*) For GSM 400, GSM 850, GSM 700 and GSM 900 MS : see 4.5.2.
 For DCS 1 800 and PCS 1900 MS : -48 dBc or -48 dBm, whichever is the higher.
 For all BTS : no requirement below -30 dBc (see 4.5.1).
- (**) For GSM 400, GSM 900, GSM 700 and GSM 850 MS : -4 dBc for power control level 16;
 -2 dBc for power control level 17;
 -1 dBc for power control levels 18 and 19-31.
 For DCS 1 800 MS : -4 dBc for power control level 11,
 -2 dBc for power control level 12,
 -1 dBc for power control levels 13, 14 and 15-28.
 For PCS 1900 MS : -4 dBc for power control level 11,
 -2 dBc for power control level 12,
 -1 dBc for power control levels 13, 14 and 15.
- (***) For GSM 400, GSM 900, GSM 700 and GSM 850 MS : -30 dBc or -17 dBm, whichever is the higher.
- For DCS 1 800 and PCS 1900 MS : -30 dBc or -20 dBm, whichever is the higher.
- (****) For all BTS and all MS : Lower limit within the useful part of burst is seen as undefined for 16-QAM and 32-QAM.

Annex C (normative): Propagation conditions

C.1 Simple wideband propagation model

Radio propagation in the mobile radio environment is described by highly dispersive multipath caused by reflection and scattering. The paths between base station and MS may be considered to consist of large reflectors and/or scatterers some distance to the MS, giving rise to a number of waves that arrive in the vicinity of the MS with random amplitudes and delays.

Close to the MS these paths are further randomized by local reflections or diffractions. Since the MS will be moving, the angle of arrival must also be taken into account, since it affects the doppler shift associated with a wave arriving from a particular direction. Echos of identical delays arise from reflectors located on an ellipse.

The multipath phenomenon may be described in the following way in terms of the time delays and the doppler shifts associated with each delay:

$$z(t) = \iint_{R^2} y(t - T)S(T, f)\exp(2i\pi fT)dfdT$$

where the terms on the right-hand side represent the delayed signals, their amplitudes and doppler spectra.

It has been shown that the criterion for wide sense stationarity is satisfied for distances of about 10 metres. Based on the wide sense stationary uncorrelated scattering (WSSUS) model, the average delay profiles and the doppler spectra are necessary to simulate the radio channel.

In order to allow practical simulation, the different propagation models will be presented here in the following terms:

- 1) a discrete number of taps, each determined by their time delay and their average power;
- 2) the Rayleigh distributed amplitude of each tap, varying according to a doppler spectrum $S(f)$.

C.2 Doppler spectrum types

In this clause, we define the two types of doppler spectra which will be used for the modelling of the channel. Throughout this clause the following abbreviations will be used:

- $f_d = v/\lambda$, represents the maximum doppler shift, with v (in ms^{-1}) representing the vehicle speed, and λ (in m) the wavelength.

The following types are defined:

- a) CLASS is the classical doppler power spectrum and will be used in all but one case;

$$\text{(CLASS)} \quad S(f) = 1/(\pi f_d (1-(f/f_d)^2)^{0.5}) \quad \text{for } f \in]-f_d, f_d[;$$

- b) RICE is the sum of a classical doppler spectrum and one direct path, such that the total multipath contribution is equal to that of the direct path. This power spectrum is used for the shortest path of the RA model;

$$\text{(RICE)} \quad S(f) = A_0/(\pi f_d (1-(f/f_d)^2)^{0.5}) + A_1 \delta(f - 0,7 f_d) \quad \text{for } f \in]-f_d, f_d[.$$

$A_0 = 0,17$ and $A_1 = 0,83$ for the six tap RA model, $A_0 = 0,13$ and $A_1 = 0,87$ for the four tap RA model.

C.3 Propagation models

In this clause the propagation models that are mentioned in the main body of 3GPP TS 45.005 are defined. As a general principle those models are referred to as NAME_x, where NAME is the name of the particular model, which is defined thereunder, and x is the vehicle speed (in km/h) which impacts on the definition of f_d (see clause C.2) and hence on the doppler spectra.

Those models are usually defined by 12 tap settings; however, according to the simulators available it may not be possible to simulate the complete model. Therefore a reduced configuration of 6 taps is also defined in those cases. This reduced configuration may be used in particular for the multipath simulation on an interfering signal. Whenever possible the full configuration should be used. For each model two equivalent alternative tap settings, indicated respectively by (1) and (2) in the appropriate columns, are given.

C.3.1 Typical case for rural area (R_{Ax}): (6 tap setting)

Tap number	Relative time (μs)		Average relative power (dB)		doppler spectrum
	(1)	(2)	(1)	(2)	
1	0,0	0,0	0,0	0,0	RICE
2	0,1	0,2	-4,0	-2,0	CLASS
3	0,2	0,4	-8,0	-10,0	CLASS
4	0,3	0,6	-12,0	-20,0	CLASS
5	0,4	-	-16,0	-	CLASS
6	0,5	-	-20,0	-	CLASS

C.3.2 Typical case for hilly terrain (H_{Tx}): (12 tap setting)

Tap number	Relative time (μs)		Average relative power (dB)		doppler spectrum
	(1)	(2)	(1)	(2)	
1	0,0	0,0	-10,0	-10,0	CLASS
2	0,1	0,2	-8,0	-8,0	CLASS
3	0,3	0,4	-6,0	-6,0	CLASS
4	0,5	0,6	-4,0	-4,0	CLASS
5	0,7	0,8	0,0	0,0	CLASS
6	1,0	2,0	0,0	0,0	CLASS
7	1,3	2,4	-4,0	-4,0	CLASS
8	15,0	15,0	-8,0	-8,0	CLASS
9	15,2	15,2	-9,0	-9,0	CLASS
10	15,7	15,8	-10,0	-10,0	CLASS
11	17,2	17,2	-12,0	-12,0	CLASS
12	20,0	20,0	-14,0	-14,0	CLASS

The reduced setting (6 taps) is defined thereunder.

Tap number	Relative time (μs)		Average relative power (dB)		doppler spectrum
	(1)	(2)	(1)	(2)	
1	0,0	0,0	0,0	0,0	CLASS
2	0,1	0,2	-1,5	-2,0	CLASS
3	0,3	0,4	-4,5	-4,0	CLASS
4	0,5	0,6	-7,5	-7,0	CLASS
5	15,0	15,0	-8,0	-6,0	CLASS
6	17,2	17,2	-17,7	-12,0	CLASS

C.3.3 Typical case for urban area (TUx): (12 tap setting)

Tap number	Relative time (μs)		Average relative power (dB)		doppler spectrum
	(1)	(2)	(1)	(2)	
1	0,0	0,0	-4,0	-4,0	CLASS
2	0,1	0,2	-3,0	-3,0	CLASS
3	0,3	0,4	0,0	0,0	CLASS
4	0,5	0,6	-2,6	-2,0	CLASS
5	0,8	0,8	-3,0	-3,0	CLASS
6	1,1	1,2	-5,0	-5,0	CLASS
7	1,3	1,4	-7,0	-7,0	CLASS
8	1,7	1,8	-5,0	-5,0	CLASS
9	2,3	2,4	-6,5	-6,0	CLASS
10	3,1	3,0	-8,6	-9,0	CLASS
11	3,2	3,2	-11,0	-11,0	CLASS
12	5,0	5,0	-10,0	-10,0	CLASS

The reduced TUx setting (6 taps) is defined thereunder.

Tap number	Relative time (μs)		Average relative power (dB)		doppler spectrum
	(1)	(2)	(1)	(2)	
1	0,0	0,0	-3,0	-3,0	CLASS
2	0,2	0,2	0,0	0,0	CLASS
3	0,5	0,6	-2,0	-2,0	CLASS
4	1,6	1,6	-6,0	-6,0	CLASS
5	2,3	2,4	-8,0	-8,0	CLASS
6	5,0	5,0	-10,0	-10,0	CLASS

C.3.4 Profile for equalization test (EQx): (6 tap setting)

Tap number	Relative time (μs)	Average relative power (dB)	doppler spectrum
1	0,0	0,0	CLASS
2	3,2	0,0	CLASS
3	6,4	0,0	CLASS
4	9,6	0,0	CLASS
5	12,8	0,0	CLASS
6	16,0	0,0	CLASS

C.3.5 Typical case for very small cells (Tlx): (2 tap setting)

Tap number	Relative time (μs)	Average relative power (dB)	Doppler spectrum
1	0.0	0.0	CLASS
2	0.4	0.0	CLASS

Annex D (normative): Environmental conditions

D.1 General

This normative annex specifies the environmental requirements for MS and BSS equipment, Within these limits the requirements of the GSM specifications shall be fulfilled.

D.2 Environmental requirements for the MSs

The requirements in this clause apply to all types of MSs.

D.2.1 Temperature (GSM 400, GSM 900 and DCS 1 800)

The MS shall fulfil all the requirements in the full temperature range of:

+15°C - +35°C for normal conditions (with relative humidity of 25 % to 75 %);

-10°C - +55°C for DCS 1 800 MS and small MS units extreme conditions
(see IEC publications 68-2-1 and 68-2-2);

-20°C - +55°C for other units extreme conditions (see IEC publications 68-2-1 and 68-2-2).

Outside this temperature range the MS, if powered on, shall not make ineffective use of the radio frequency spectrum. In no case shall the MS exceed the transmitted levels as defined in 3GPP TS 45.005 for extreme operation.

D.2.1.1 Environmental Conditions (PCS 1 900, GSM 850 and GSM 700)

Normal environmental conditions are defined as any combination of the following:

Temperature Range	+15°C to +35°C
Relative Humidity	35% to 75%
Air Pressure	86 kPa to 106 kPa

Extreme operating temperature ranges depend on the specific manufacturer and application, but typical ranges are as follows:

MS Temperature Range: -10°C to +55°C

D.2.2 Voltage

The MS shall fulfil all the requirements in the full voltage range, i.e. the voltage range between the extreme voltages.

The manufacturer shall declare the lower and higher extreme voltages and the approximate shut-down voltage. For the equipment that can be operated from one or more of the power sources listed below, the lower extreme voltage shall not be higher, and the higher extreme voltage shall not be lower than that specified below.

Power source	Lower extreme voltage	Higher extreme voltage	Normal cond. voltage
AC mains	0,9 * nominal	1,1 * nominal	nominal
Regulated lead acid battery	0,9 * nominal	1,3 * nominal	1,1 * nominal
Non regulated batteries:			
Leclanché	0,85 * nominal	nominal	nominal
lithium	0,95 * nominal	1,1 * nominal	1,1 * nominal
mercury/nickel cadmium	0,9 * nominal	nominal	nominal

Outside this voltage range the MS, if powered on, shall not make ineffective use of the radio frequency spectrum. In no case shall the MS exceed the transmitted levels as defined in 3GPP TS 45.005 for extreme operation. In particular, the MS shall inhibit all RF transmissions when the power supply voltage is below the manufacturer declared shut-down voltage.

D.2.3 Vibration (GSM 400, GSM 900 and DCS 1 800)

The MS shall fulfil all the requirements when vibrated at the following frequency/amplitudes:

Frequency ASD (Acceleration Spectral Density) random vibration

5 Hz to 20 Hz 0,96 m²/s³

20 Hz to 500 Hz 0,96 m²/s³ at 20 Hz, thereafter -3 dB/Octave

(see IEC publication 68-2-36)

Outside the specified frequency range the MS, if powered on, shall not make ineffective use of the radio frequency spectrum. In no case shall the MS exceed the transmitted levels as defined in 3GPP TS 45.005 for extreme operation.

D.2.3.1 Vibration (PCS 1 900, GSM 850 and GSM 700)

10 – 100 Hz: 3 m²/s³ (0.0132 g²/Hz)

100 – 500 Hz: -3dB/Octave

D.3 Environmental requirements for the BSS equipment

This clause applies to both GSM 400, GSM 900 and DCS 1 800 BSS equipment.

The BSS equipment shall fulfil all the requirements in the full range of environmental conditions for the relevant environmental class from the relevant ETSs listed below:

ETS 300 019-1-3: Equipment Engineering (EE); Environmental conditions and environmental tests for telecommunications equipment, Part 1-3: Classification of environmental conditions, Stationary use at weather protected locations.

ETS 300 019-1-4: Equipment Engineering (EE); Environmental conditions and environmental tests for telecommunications equipment, Part 1-4: Classification of environmental conditions, Stationary use at non-weather protected locations.

The operator can specify the range of environmental conditions according to his needs.

Outside the specified range for any of the environmental conditions, the BTS shall not make ineffective use of the radio frequency spectrum. In no case shall the BTS exceed the transmitted levels as defined in 3GPP TS 45.005 for extreme operation.

D.3.1 Environmental requirements for the BSS equipment

The following clause applies to the GSM 700, GSM 850, PCS 1 900, MXM 850, MXM 1900 BSS.

Normal environmental conditions are defined as any combination of the following:

Temperature Range	+15°C to +35°C
Relative Humidity	35% to 75%
Air Pressure	86 kPa to 106 kPa

Extreme operating temperature ranges depend on the specific manufacturer and application, but typical ranges are as follows:

BSS Indoor Temperature Range:	-5°C to +50°C
BSS Outdoor Temperature Range:	-40°C to +50°C

Annex E (normative): Repeater characteristics

E.1 Introduction

A repeater receives amplifies and transmits simultaneously both the radiated RF carrier in the downlink direction (from the base station to the mobile area) and in the uplink direction (from the mobile to the base station).

This annex details the minimum radio frequency performance of repeaters operating in frequency bands defined in clause 2 of this document. The environmental conditions for repeaters are specified in annex D.3, of 3GPP TS 45.005. The precise measurement methods for repeaters are specified in 3GPP TS 51.026 [35]. Further application dependant requirements on repeaters need to be considered by operators before they are deployed. These network planning aspects of repeaters are covered in 3GPP TR 43.030.

The following requirements apply to the uplink and downlink directions.

In clauses 2 and 3 the maximum output power per carrier is the value declared by the manufacturer.

BTS and MS transmit bands are as defined in clause 2 of 3GPP TS 45.005.

E.2 Spurious emissions

At maximum repeater gain, with or without a continuous static sine wave input signal in the operating band of the repeater, at a level which produces the manufacturers maximum rated power output, the following requirements shall be met.

The average power of any single spurious measured in a 3 kHz bandwidth shall be no greater than:

- 250 nW (-36 dBm) in the relevant MS and BTS transmit frequency bands for a repeater operating in transmit frequency bands below 1 GHz at offsets of > 100 kHz from the carrier.
- 1 μ W (-30 dBm) in the relevant MS and BTS transmit frequency bands for a repeater operating in transmit frequency bands above 1 GHz at offsets of > 100 kHz from the carrier.

Outside of the relevant transmit bands the power measured in the bandwidths according to table E.2-1, shall be no greater than:

- 250 nW (-36 dBm) in the frequency band 9 kHz to 1 GHz;
- 1 μ W (-30 dBm) in the frequency band 1 GHz to 12,75 GHz.

Table E.2-1 Measurement bandwidth for spurious emissions

Band	Frequency offset	Measurement bandwidth
100 kHz - 50 MHz	-	10 kHz
50 MHz - 500 MHz outside the relevant BTS transmit band or MS transmit band	(offset from edge of the relevant transmit band)-	
	> 0 MHz	10 kHz
	≥ 2 MHz	30 kHz
	≥ 5 MHz	100 kHz
above 500 MHz outside the relevant BTS Transmit band or MS transmit band	(offset from edge of the relevant above band)	
	> 0 MHz	10 kHz
	≥ 2 MHz	30 kHz
	≥ 5 MHz	100 kHz
	≥ 10 MHz	300 kHz
	≥ 20 MHz	1 MHz
	≥ 30 MHz	3 MHz

The requirement applies to all ports of the repeater.

NOTE: For radiated spurious emissions, the specifications currently only apply to the frequency band 30 MHz to 4 GHz. The specification and method of measurement outside this band are under consideration.

E.3 Intermodulation products

At maximum repeater gain, with two continuous static sine wave input signals in the operating band of the repeater, at equal levels which produce the maximum rated power output per carrier, the average power of any intermodulation products measured in a 3 kHz bandwidth shall be no greater than:

- 250 nW (-36 dBm) in the frequency band 9 kHz to 1 GHz;
- 1 μW (-30 dBm) in the frequency band 1 GHz to 12,75 GHz.

When the two input signals are simultaneously increased by 10 dB each, the requirements shall still be met.

The requirement applies to all ports of the repeater.

E.4 Out of band gain

The following requirements apply at all frequencies from 9 kHz to 12.75 GHz excluding the relevant transmit bands.

The net out of band gain in both directions through the repeater shall be less than +50 dB at 400 kHz, +40 dB at 600 kHz, +35 dB at 1 MHz and +25 dB at 5 MHz offset and greater from the edges of the BTS and MS transmit bands.

In special circumstances additional filtering may be required out of band and reference should be made to 3GPP TR 43.030.

E.5 Frequency error and modulation accuracy

E.5.1 Frequency error

This clause applies only to repeater systems using frequency shift.

The average frequency deviation of the output signal with respect to the input signal of the repeater system shall not be more than 0,1 ppm. The specified value applies to a complete repeater system signal path. Consequently a single repeater unit is limited to an average frequency deviation of not more than 0.05 ppm with respect to its wanted output frequency.

E.5.2 Modulation accuracy at GMSK modulation

This clause applies only to repeater systems using frequency shift.

For a complete repeater system operating at the nominal output power as specified by the manufacturer shall the increase in phase error of a GSM input signal, which meets the phase error requirements of subclause 4.6, not exceed the values in subclause 4.6 by 2 degrees RMS and by 8 degrees peak. For a single repeater unit operating at the nominal output power as specified by the manufacturer shall the increase in phase error of a GSM input signal, which meets the phase error requirements of subclause 4.6, not exceed the values in subclause 4.6 by 1.1 degrees RMS and by 4.5 degrees peak.

E.5.3 Modulation accuracy at 8-PSK, 16-QAM, 32-QAM, QPSK and AQPSK modulation

This clause applies only to repeater systems supporting 8-PSK, 16-QAM, 32-QAM, QPSK and/or AQPSK.

For a repeater as defined in the first column of the table E.5-1 below and operating at the nominal output power as specified by the manufacturer, the RMS EVM of the output RF signal for an ideal GSM 8-PSK, 16-QAM, 32-QAM, QPSK and AQPSK input signal (if supported) according to subclause 4.6, shall not exceed the requirement as defined in the table below.

Table E.5-1 EVM requirements for higher order modulations

		Normal symbol rate				Higher symbol rate		
		AQPSK ⁽¹⁾	8-PSK	16-QAM	32-QAM	QPSK	16-QAM	32-QAM
For a single repeater with no shift in frequency from input to output	under normal conditions	4,0%	3,0 %	4,0 %	4,0 %	8,0 %	5,0 %	4,0 %
For a single repeater with no shift in frequency from input to output	under extreme conditions	5,0%	3,0 %	5,0 %	5,0 %	8,0 %	5,0 %	5,0 %
For a complete repeater system using frequency shift	under normal conditions	6,0%	11 %	5,0 %	5,0 %	11 %	5,0 %	6,0 %
For a complete repeater system using frequency shift	under extreme conditions	7,0%	11 %	7,0 %	7,0 %	11 %	5,0 %	7,0 %

E 1: Only for downlink, regardless of SCPIR_DL value falling in the range defined in 3GPP TS 45.004 Clause 6.2.

NOTE: Repeaters with higher RMS EVM value may be used in systems utilizing 8-PSK, 16-QAM, 32-QAM, QPSK and AQPSK, if all other repeater requirements in this Annex are fulfilled. However, the system performance will be degraded.

In addition the origin offset suppression according to Annex G shall not exceed -35 dBc.

Annex F (normative): Antenna Feeder Loss Compensator Characteristics (GSM 400, GSM 900 and DCS 1800)

F.1 Introduction

An Antenna Feeder Loss Compensator (AFLC) is physically connected between the MS and the antenna in a vehicle mounted installation. It amplifies the signal received in the downlink direction and the signal transmitted in the uplink direction, with a gain nominally equal to the loss of the feeder cable. Unless otherwise stated, the requirements defined in this specification apply to the full range of environmental conditions specified for the AFLC (see annex D2 of 3GPP TS 45.005).

This specification details the minimum radio frequency performance of GSM AFLC devices. The environmental conditions for the AFLC are specified in annex D.2 of 3GPP TS 45.005. It also includes informative guidelines on the use and design of the AFLC.

The following requirements apply to AFLC devices intended for use in the GSM 400, GSM 900 and DCS 1 800 frequency bands. For GSM 900, the requirements apply to an AFLC intended for use with a GSM 400 and GSM 900 class 4 MS. For DCS 1 800, the requirements apply to an AFLC intended for use with a DCS 1 800 class 1 MS. For compatibility reasons, a GSM 900 AFLC is required to support the Extended GSM band.

The requirements apply to the AFLC, including all associated feeder and connecting cables. A 50 ohm measurement impedance is assumed.

When referred to in this specification:

- the maximum rated output power for a GSM 400 and GSM 900 AFLC is +33 dBm and for a DCS 1 800 AFLC is +30 dBm;
- a GSM input signal, is a GMSK signal modulated with random data, which meets the performance requirements of 3GPP TS 45.005, for an MS of equivalent output power. The power level specified for the GSM input signal, is the power averaged over the useful part of the burst.

F.2 Transmitting path

Unless otherwise stated, the requirements in this clause apply at all frequencies in the transmit band 450,4 MHz to 457,6 MHz for a GSM 450 AFLC, at all frequencies in the transmit band 478,8 MHz to 486 MHz for a GSM 480 AFLC, at all frequencies in the transmit band 880 MHz to 915 MHz for a GSM 900 AFLC, and at all frequencies in the transmit band 1 710 MHz to 1 785 MHz, for a DCS 1 800 AFLC. For a multi band AFLC, which supports more than one, the requirements apply in any transmit bands implemented.

F.2.1 Maximum output power

With a GSM input signal at a level of X dBm, the maximum output power shall be less than a level of Y dBm. The values of X and Y for GSM 400, GSM 900 and DCS 1 800 are given in table F.2-1.

Table F.2-1: Input and output levels for testing maximum output power

	GSM 400 and GSM 900	DCS 1 800
X	+39 dBm	+36 dBm
Y	+35 dBm	+32 dBm

F.2.2 Gain

With a GSM input signal, at a level which produces the maximum rated output power, the AFLC gain shall be 0 dB with a tolerance of ± 1 dB, over the relevant transmit band.

For a GSM 400 and GSM 900 AFLC, with the input level reduced in 14 steps of 2 dB, the net path gain over the relevant transmit band shall be 0 dB, with a tolerance of ± 1 dB, for the first 10 reduced input levels and ± 2 dB for the 4 lowest input levels.

For a DCS 1 800 AFLC, with the input level reduced in 15 steps of 2 dB, the net path gain over the relevant transmit band shall be 0 dB, with a tolerance of ± 1 dB, for the first 13 reduced input levels and ± 2 dB for the 2 lowest input levels.

In frequency bands which are not supported, the gain shall be no greater than the maximum value in the relevant transmit band.

F.2.3 Burst transmission characteristics

With a GSM input signal, the shape of the GSM AFLC output signal related to this input signal shall meet the tolerances of tables F.2-2a and F.2-3. With a DCS input signal, the shape of the DCS AFLC shall meet the tolerances of tables F.2-2b and F.2-3.

NOTE: The tolerances on the output signal correspond to the time mask of 3GPP TS 45.005, with the input signal in the middle of the tolerance field.

Table F.2-2a: Timing tolerances between input and output signals for a GSM AFLC

Input signal level	Input signal time	Output signal level	Tolerances - output signal time
-59 dBc (or -54 dBm whichever is greater)	t59	-59 dBc	t59 \pm 14 μ s
-30 dBc	t30	-30 dBc	t30 \pm 9 μ s
-6 dBc	t6	-6 dBc	t6 \pm 5 μ s

Table F.2-2b: Timing tolerances between input and output signals for a DCS AFLC

Input signal level	Input signal time	Output signal level	Tolerances - output signal time
-48 dBc (or -48 dBm whichever is greater)	t48	-48 dBc	t48 \pm 14 μ s
-30 dBc	t30	-30 dBc	t30 \pm 9 μ s
-6 dBc	t6	-6 dBc	t6 \pm 5 μ s

The input signal time is the time at which the input level crosses the corresponding signal level. The above requirements apply to both the rising and falling edge of the burst.

Table F.2-3: Signal level tolerances for both GSM and DCS AFLC

Range	Tolerances - output signal level
t6.....t6 \pm 5 μ s (rising edge)	-6.....+4 dB
t6.....t6 \pm 5 μ s (falling edge)	-6.....+1 dB
147 useful bits	\pm 1 dB

All input signal levels are relative to the average power level over the 147 useful bits of the input signal. All output signal levels are relative to the average power level over the 147 useful bits of the output signal.

F.2.4 Phase error

The increase in phase error of a GSM input signal, which meets the phase error requirements of 3GPP TS 45.005, shall be no greater than 2 degrees RMS and 8 degrees peak.

F.2.5 Frequency error

The increase in frequency error of a GSM input signal, which meets the frequency accuracy requirements of 3GPP TS 45.010, shall be no greater than 0,05 ppm.

F.2.6 Group delay

The absolute value of the group delay (signal propagation delay) shall not exceed 500 ns.

F.2.7 Spurious emissions

With a GSM input signal corresponding to an MS transmitting at +39 dBm for a GSM 900 AFLC, and at +36 dBm for a DCS 1 800 AFLC, the peak power of any single spurious emission measured in a bandwidth according to table F.2-4, shall be no greater than -36 dBm in the relevant transmit band.

Table F.2-4: Transmit band spurious emissions measurement conditions

Band	Frequency	Measurement bandwidth
relevant transmit band and < 2 MHz offset from band edge	offset from test signal freq.	
	≥ 1,8 MHz	30 kHz
	≥ 6,0 MHz	100 kHz

Outside of this transmit band, the power measured in the bandwidths according to table F.2-5 below, shall be no greater than:

- 250 nW (-36 dBm) in the frequency band 9 kHz - 1 GHz;
- 1 μW (-30 dBm) in the frequency band 1 - 12,75 GHz

Table F.2-5: Out of band spurious emissions measurement conditions

Band	Frequency offset	Measurement Bandwidth
100 kHz - 50 MHz	-	10 kHz
50 MHz -500 MHz	-	100 kHz
above 500 MHz but excluding the transmit band	(offset from edge of the transmit band)	
	≥ 2 MHz	30 kHz
	≥ 5 MHz	100 kHz
	≥ 10 MHz	300 kHz
	≥ 20 MHz	1 MHz
	≥ 30 MHz	3 MHz

In the band 935 - 960 MHz, the power measured in any 100 kHz band shall be no more than -79 dBm, in the band 925 - 935, 460.4 – 467.6 MHz and 488.8 – 496 MHz, shall be no more than -67 dBm and in the band 1 805 - 1 880 MHz, shall be no more than -71 dBm.

With no input signal and the MS input port terminated and unterminated, the peak power of any single spurious emission measured in a 100 kHz bandwidth shall be no greater than:

- 2 nW (-57 dBm) in the frequency bands 9 kHz - 880 MHz, 915 - 1 000 MHz;
- 1,25 nW (-59 dBm) in the frequency band 880 - 915 MHz;
- 5 nW (-53 dBm) in the frequency band 1 710 - 1 785 MHz;
- 20 nW (-47 dBm) in the frequency bands 1 000 - 1 710 MHz, 1 785 - 12 750 MHz.

F.2.8 VSWR

The VSWR shall be less than 1.7:1 at the RF port of the device which is intended to be connected to the MS. The VSWR shall be less than 2:1 at the RF port of the device which is intended to be connected to the antenna.

F.2.9 Stability

The AFLC shall be unconditionally stable.

F.3 Receiving path

Unless otherwise stated, the requirements in this clause apply at all frequencies in the receive band 460.4 – 467.6 MHz for a GSM 450 AFLC, at all frequencies in the receive band 488.8 - 496 MHz for a GSM 480 AFLC, at all frequencies in the receive band 925 - 960 MHz for a GSM 900 AFLC, and at all frequencies in the receive band 1 805 - 1 880 MHz, for a DCS 1 800 AFLC. For a multi band AFLC, which supports more than one of the GSM and DCS bands, the requirements apply in all of the receive bands supported.

F.3.1 Gain

With a GSM input signal at any level in the range -102 dBm to -20 dBm for a GSM 400 and GSM 900 AFLC and -100 dBm to -20 dBm for a DCS 1 800 AFLC, the gain shall be 0 dB with a tolerance of ± 1 dB.

For test purposes, it is sufficient to use a CW signal to test this requirement.

F.3.2 Noise figure

The noise figure shall be less than 7 dB for a GSM 400 and GSM 900 AFLC and less than 7 dB for a DCS 1 800 AFLC.

F.3.3 Group delay

The absolute value of the group delay (signal propagation delay) shall not exceed 500 ns.

F.3.4 Intermodulation performance

The output third order intercept point shall be greater than -10 dBm.

F.3.5 VSWR

The VSWR shall be less than 1.7:1 at the RF port of the device which is intended to be connected to the MS. The VSWR shall be less than 2:1 at the RF port of the device which is intended to be connected to the antenna.

F.3.6 Stability

The AFLC shall be unconditionally stable.

F.4 Guidelines (informative)

The specifications of the AFLC, have been developed to ensure that a generic AFLC causes minimal degradation of the parametric performance of the MS, to which it is connected.

The following should be clearly marked on the AFLC:

- The intended band(s) of operation.
- The power class of the MS, to which it designed to be connected.

When installed correctly the AFLC can provide enhancement of the MS to BTS link in vehicular installations. However, it is not guaranteed that an AFLC, which meets the requirements of this specification, will provide a performance improvement for all of the different GSM MS implementations and installations.

Some MS implementations significantly exceed the performance requirements of 3GPP TS 45.005, e.g. with respect to reference sensitivity performance. A purely passive feeder of low loss cable, may provide the best performance for some implementations. The benefits of installing an AFLC in a vehicular application, can only be assessed on a case by case basis.

When used, the AFLC should only be installed in the type approved configuration, with the minimum amount of additional cabling.

When designing an AFLC to be used with a GSM MS, the best downlink performance will be obtained if the low noise amplifier is situated as closely as possible to the output of the antenna.

Annex G (normative): Calculation of Error Vector Magnitude

The Error Vector Magnitude (EVM) is computed at the symbol times in the useful part of the burst (excluding tail symbols).

Let $Y(t)$ be the complex signal produced by observing the real transmitter at instant t . $R(t)$ is defined to be an ideal transmitted signal. The symbol timing phase of $Y(t)$ is aligned with the ideal signal. The transmitter is modelled as:

$$Y(t) = C1\{R(t) + D(t) + C0\}W^t$$

where

$W = e^{\alpha + j\omega}$ accounts for both a frequency offset of " ω " radians per second phase rotation and an amplitude change of " α " nepers per second,

$C0$ is a constant origin offset representing carrier feedthrough,

$C1$ is a complex constant representing the arbitrary phase and output power of the transmitter and

$D(t)$ is the residual complex error on signal $R(t)$.

$Y(t)$ is compensated in amplitude, frequency and phase by multiplying by the complex factor

$$W^{-t}/C1$$

After compensation, $Y(t)$ is passed through the specified measurement filter to produce the signal

$$Z(k) = S(k) + E(k) + C0$$

where

$S(k)$ is the ideal transmitter signal observed through the measurement filter.

$k = \text{floor}(t/T_s)$, where T_s corresponds to the symbol time.

($T_s = 48/13 \mu\text{sec}$ or $1/270.833\text{kHz}$ for normal symbol rate, and $T_s = 40/13 \mu\text{sec}$ for higher symbol rate)

The error vector $\mathbf{E}(k)$

$$\mathbf{E}(k) = Z(k) - C0 - S(k)$$

is measured and calculated for each instant k .

The sum square vector error for each component is calculated over one burst. The relative RMS vector error is defined as:

$$\text{RMS EVM} = \sqrt{\frac{\sum_{k \in K} |\mathbf{E}(k)|^2}{\sum_{k \in K} |S(k)|^2}} \quad \text{and shall not exceed the specified value.}$$

The symbol vector error magnitude (EVM) at symbol k is defined as

$$\text{EVM}(k) = \frac{\sqrt{|\mathbf{E}(k)|^2}}{\sqrt{\frac{\sum_{k \in K} |S(k)|^2}{N}}},$$

where N is the number of elements in the set K . $\text{EVM}(k)$ is the vector error length relative the root average energy of the useful part of the burst.

C_0 , C_1 and W shall be chosen to minimise RMS EVM per burst and are then used to compute the individual vector errors $E(k)$ on each symbol. The symbol timing phase of the samples used to compute the vector error should also be chosen to give the lowest value for the RMS EVM.

Origin offset suppression (in dB) is defined as

$$\text{OOS (dB)} = -10 \log_{10} \left(\frac{|C_0|^2}{\frac{1}{N} \sum_{k \in K} |S(k)|^2} \right)$$

The minimum value of origin offset suppression is specified separately.

In the above equation, the errors shall be measured after a measurement receive filter at baseband. The specification is based on using the specified, windowed, raised-cosine, filter with roll-off 0.25 and single side-band bandwidth of 90 kHz for normal symbol rate and for higher symbol-rate using narrow pulse-shaping filter, and the specified, windowed, raised-cosine, filter with roll-off 0.25 and single side-band bandwidth of 108 kHz for higher symbol rate using wide pulse-shaping filter as the measurement receive filter (see 4.6.2). Sufficient over-sampling is assumed (at least 4 times).

Annex H (normative): Requirements on Location Measurement Unit

Location Services utilizes Location Measurement Units (LMU) to support its positioning mechanisms. An LMU is additional measurement hardware in the GSM network. Time Of Arrival (TOA) positioning mechanism requires LMUs to make accurate measurement of the TOA of the access bursts emitted by the MS. Enhanced Observed Time Difference positioning mechanism requires LMUs in unsynchronized networks to measure the time difference of BTS signals received.

Section H.1 and its subsections specify LMU requirements to support the Time Of Arrival positioning mechanism.

Section H.2 and its subsections specify LMU requirements to support the Enhanced Observed Time Difference positioning mechanism.

An LMU may contain a control mobile station to communicate with the network. In that case, the requirements for a normal mobile station shall apply to this control mobile station.

H.1 TOA LMU Requirements

A TOA Location Measurement Unit (LMU) is a unit for making accurate Time-of-Arrival (TOA) measurements. Specifically, the LMU shall be capable of measuring the Time-of-Arrival of access bursts that are transmitted from a mobile station on request. The measurement results are used by the system for determining the location of the mobile station as described in 3GPP TS 43.059. This section defines the requirements for the receiver of an LMU deployed in the GSM system. Requirements are defined for the Time-of-Arrival measurement accuracy of the LMU.

In addition, an LMU shall be capable of performing Radio Interface Timing (RIT) measurements, comprising Absolute Time Differences (ATD), as described in 3GPP TS 43.059.

H.1.1 Void

H.1.2 LMU characteristics

In this clause, the requirements are given in terms of power levels at the antenna connector of an LMU. Equipment with an integral antenna may be taken into account in a similar manner as described in Chapter 5 of 3GPP TS 45.005.

H.1.2.1 Blocking characteristics

This subclause defines receiver blocking requirements. The reference sensitivity performance as specified in Table H.1-2 shall be met when the following signals are simultaneously input to the LMU.

- A carrier signal as described in H.1.3.1 at frequency f_0 , 9 dB above the reference sensitivity level as specified in Table H.1-1.
- A continuous static sine wave signal as described in Section 5.1 of 3GPP TS 45.005. The requirements for normal "BTS" shall be used, however the signal strength shall be 6 dB higher than the requirements for "normal BTS".

The exceptions listed in Section 5.1 of 3GPP TS 45.005 apply also for the LMU requirements.

H.1.2.2 AM suppression characteristics

This subclause defines AM suppression requirements. The reference sensitivity performance as specified in Table H.1-2 shall be met when the following signals are simultaneously input to the LMU.

- A carrier signal as described in H.1.3.1 at frequency f_0 , 9 dB above the reference sensitivity level as specified in Table H.1-1.

- A single frequency signal as described in Section 5.2 of 3GPP TS 45.005. The requirements for "normal BTS" shall be used, however the signal strength shall be 6 dB higher than the requirements for "normal BTS".

H.1.2.3 Intermodulation characteristics

This subclause defines intermodulation requirements. The reference sensitivity performance as specified in Table H.1-2 shall be met when the following signals are simultaneously input to the LMU.

- A carrier signal as described in H.1.3.1 at frequency f_0 , 9 dB above the reference sensitivity level as specified in Table H.1-1.
- A continuous static sine wave signal and any 148-bit subsequence of the 511-bits pseudo-random sequence in CCITT O.153. The signal strength shall be 6 dB higher than as described in Section 5.3 of 3GPP TS 45.005.

H.1.2.4 Spurious emissions

The requirements for a BTS receiver as specified in section 5.4 of 3GPP TS 45.005 shall apply also to the receiver of an LMU.

H.1.3 Time-of-Arrival Measurement Performance

This clause specifies the required Time-of-Arrival (TOA) measurement accuracy of the LMU with and without interference and different channel conditions. The requirements are given in terms of Time-of-Arrival measurement error (in microseconds) as a function of the carrier and interference input power levels at the antenna connector of the receiver. Equipment with an integral antenna may be taken into account in a similar manner as described in Chapter 5 of 3GPP TS 45.005.

The power level, under multipath fading conditions, is the mean power of the sum of the individual paths.

H.1.3.1 Sensitivity Performance

With the following configuration and propagation conditions, the LMU shall meet the requirements for 90% RMS TOA error (RMS_{90}) defined in Table H.1-2.

- A carrier signal of GMSK modulated random access bursts is fed into the LMU. The duration of the carrier signal is 320 ms. The access bursts occur once every TDMA frame in a 26-frame multiframe, except in frame number 12 and 25.

NOTE: Since it is an implementation option in the MS whether or not a MS transmits access bursts during SACCH frames (i.e. frame number 12 or 25 in a 26-frame multiframe), this test carrier signal specifies the worst case under which the requirements shall be met.

- The access bursts consist of a fixed training sequence according to 3GPP TS 45.002 and a data part. The data part of the access burst is random but constant over one 320 ms measurement trial. The data part of the access burst is made known to the LMU before a measurement starts.
- The power up and power down ramping for the bursts is in accordance with Annex B of 3GPP TS 45.005.
- The measurement accuracy of the LMU is defined as the root-mean-square (RMS) value of the most accurate 90% of TOA measurements. As an example, if $\{x_1..x_N\}$ is a set of the absolute square Time-of-Arrival measurement errors for N trials, sorted in ascending order, the RMS of 90% is defined as

$$\text{RMS}_{90} = \sqrt{\text{sum}(x_1..x_M)/M} \text{ where } M \text{ is the largest integer such that } M < 0.9 N.$$

For the test, $N > 500$ trials is recommended.

- Measurements shall be performed at two signal strength levels for each of two different propagation conditions. The signal strength level requirement in Table H.1-2 is expressed relative to the reference sensitivity level defined in Table H.1-1.

- For each signal strength, the two channel conditions are:
 - 1) Static
 - 2) Rayleigh (the signal fades with a Rayleigh amplitude distribution and perfect decorrelation between the bursts).

Note: Perfect decorrelation between bursts may be attained using a 100 km/hr mobile velocity for the Rayleigh faded channel.

- The LMU is informed of the true Time-of-Arrival value - with an uncertainty of 20 bit periods (approx. 70µs) - prior to the measurement. This defines a search window of +/-10 bit periods during which the true Time-of-Arrival will occur (per 3GPP TS 44.071 Annex B, paragraph 3.5). The true Time-of-Arrival value shall be uniformly distributed within the search window for each measurement trial. The TOA measurement error is then defined as the difference between this true Time-of-Arrival value minus the measured TOA value at the LMU.

Table H.1-1: Reference Sensitivity Level

Signal strength at antenna connector	
GSM 400, GSM 700, GSM 850, GSM 900, DCS 1800, PCS 1900	-123 dBm

**Table H.1-2: Sensitivity performance
(RMS₉₀ of Time-of-Arrival error in microseconds)**

Carrier signal strength relative to reference sensitivity level	Static	Rayleigh
0 dB	0.37	0.37
20 dB	0.18	0.18

H.1.3.2 Interference Performance

In this subclause, requirements are given in terms of the TOA measurement accuracy (in microseconds) for a specified carrier to interference ratio (*C/I*) at the antenna connector of the receiver. The input carrier signal shall be as defined in subclause H.1.3.1 and shall be set to a level 40 dB above the reference sensitivity level defined in Table H.1-1. The *C/I* requirements shall be met for an interference signal which is co-channel, adjacent channel (200 kHz offset), and alternate channel (400 kHz offset) to the desired signal as specified in table H.1-3.

The interference signal properties and propagation conditions are defined below.

- One interfering signal is present which consists of a sequence of GMSK modulated normal bursts. The training sequence is chosen randomly from the 8 possible normal burst TSC"s defined in 3GPP TS 45.002, but kept fixed during one 320 ms measurement trial.
- The time offset between the carrier and the interferer signal is uniformly distributed random between 0 and 156.25 bit periods, but fixed during one 320 ms measurement trial. The length of the carrier burst (access burst) is 88 bit periods, the length of one burst period is 156.25 bit periods, and the length of the interferer training sequence is 26 bit periods. The probability that the interference training sequence overlaps with some part of the carrier burst is therefore $(88+26)/156.25 = 73\%$.
- Each interference condition shall meet the *C/I* requirements in Table H.1-3 for the following channel conditions:
 - 1) Static
 - 2) Rayleigh (the signal and interference fade independently with a Rayleigh amplitude distribution that has perfect decorrelation between bursts).

NOTE 1: Perfect decorrelation between bursts may be attained using a 100 km/hr mobile velocity for the Rayleigh faded channel.

- A search window of 20 bit periods shall be used as defined in section H.1.3.1.

NOTE 2: In the case of frequency hopping, the interference and carrier signal shall have the same frequency hopping sequence.

**Table H.1-3: Interference performance
(RMS₉₀ of Time-of-Arrival error in microseconds)**

Interference type	90% RMS TOA Error		Carrier to Interference Level (dB)
	Static	Rayleigh	
Co-channel	0,37	0,37	-9 dB
	0,18	0,18	5 dB
Adjacent channel (200 kHz)	0,37	0,37	-20 dB
	0,18	0,18	-10 dB
Adjacent channel (400 kHz)	0,37	0,37	-50 dB
	0,18	0,18	-40 dB

H.1.3.3 Multipath Performance

This subclause defines TOA estimation accuracy under multipath conditions. The test setup is per H.1.3.1 (sensitivity performance) with the following changes:

- Each burst propagates through the TU multipath channel specified in Annex C of 3GPP TS 45.005. The true Time-of-Arrival value is the time of the first tap (tap number 1).
- Ideal FH is assumed, i.e. perfect decorrelation between bursts.

NOTE: Perfect decorrelation between bursts may be approximated by using frequency hopping or a 100 km/hr mobile velocity with the TU channel model.

The performance requirements are specified in table H.1-4.

**Table H.1-4: Multipath performance
(RMS₉₀ of Time-of-Arrival error in microseconds)**

Carrier signal strength relative to reference (Table H.1-1)	TU3/100 (12 tap setting)
0 dB	0,5
20 dB	0,4

H.1.4 Radio Interface Timing Measurement Performance

A Location Measurement Unit shall be capable of performing Radio Interface Timing (RIT) measurements as described in 3GPP TS 43.059 to support one or more positioning methods. RIT measurements comprise measurements of the synchronization difference between two base transceiver stations. An LMU shall therefore be capable of monitoring multiple base transceiver stations. The measurements of BTS synchronization differences can either be performed relative to a reference BTS (i.e. RTD measurement) or relative to some absolute time scale (i.e. ATD measurement).

The RIT measurement shall be made with an accuracy of ± 2 bit periods.

H.2 E-OTD LMU Requirements

An E-OTD Location Measurement Unit (LMU) is a unit that makes accurate observed time difference measurements of signals from BTSs. Specifically, the LMU shall be capable of measuring the Time-of-Arrival of bursts transmitted from a BTS on a periodic and predictable basis. The measurement results are used by the system for determining location of a MS. This clause defines the requirements to be put on the receiver of an LMU deployed in the GSM System. Requirements are defined for the E-OTD measurement accuracy of the LMU.

H.2.1 LMU Characteristics

In this clause, the requirements are given in terms of power levels at the antenna connector of the E-OTD LMU. Equipment with an integral antenna may be taken into account in a similar manner as described in Chapter 5 of 3GPP TS 45.005.

H.2.1.1 Blocking characteristics

This subclause defines E-OTD LMU receiver blocking requirements. The reference sensitivity performance as specified in table H.2-2 shall be met when the following signals are simultaneously input to the LMU.

- A neighbour BCCH carrier as described in H.2.2.1 at frequency f_o , 11 dB above the reference sensitivity level as specified in Table H.2-1.
- A continuous static sine wave signal as described in Section 5.1 of 3GPP TS 45.005. For GSM 400 and GSM 900, the requirements for "other MS" shall be used. For GSM 700, GSM 850, DCS 1800 and PCS 1900, the requirements for "MS" shall be used.

The exceptions listed in Section 5.1 of 3GPP TS 45.005 apply also for the E-OTD LMU requirements.

H.2.1.2 AM suppression characteristics

This subclause defines AM suppression requirements. The reference sensitivity performance as specified in Table H.2-2 shall be met when the following signals are simultaneously input to the LMU.

- A neighbour BCCH carrier as described in subclause H.2.2.1 at frequency f_o , 11 dB above the reference sensitivity level as specified in table H.2-1.
- A single frequency signal as described in subclause 5.2 of 3GPP TS 45.005. The requirements for "MS" shall be used.

H.2.1.3 Intermodulation characteristics

This subclause defines intermodulation requirements. The reference sensitivity performance as specified in Table H.2-2 shall be met when the following signals are simultaneously input to the LMU.

- A neighbour BCCH carrier as described in subclause H.2.2.1 at frequency f_o , 11 dB above the reference sensitivity level as specified in table H.2-1.
- A continuous static sine wave signal and any 148-bit subsequence of the 511-bits pseudo-random sequence in CCITT Recommendation O.153, as described in subclause 5.3 of 3GPP TS 45.005.

H.2.2 Sensitivity and Interference Performance

This clause specifies the required E-OTD measurement accuracy of the LMU with and without interference. The requirements are given in terms of E-OTD measurement error (in microseconds), as function of the carrier and interference input power levels, at the antenna connector of the receiver. Equipment with an integral antenna may be taken into account in a similar manner as described in clause 5 of 3GPP TS 45.005.

The power level, under multipath fading condition, is the mean power of the sum of the individual paths.

H.2.2.1 Sensitivity Performance

With the following configuration and propagation conditions, the LMU shall meet the requirements of 90% RMS E-OTD error defined in table H.2-2.

- The E-OTD LMU receives a reference BCCH carrier with a power level of 28 dB above the reference sensitivity level defined in table H.2-1.
- The E-OTD measurements (relative to the reference BCCH carrier) are done on a neighbour BCCH carrier at power levels relative to the reference sensitivity level defined in Table H.2-1. The measurement power levels are given in Table H.2-2.
- The network requests an E-OTD measurement by commanding the LMU to report the E-OTD measurement with shortest possible reporting period (see 3GPP TS 44.071 Annex A).

- The measurement performance shall also be achieved with the reference BCCH and the neighbour BCCH carriers having 8-PSK, QPSK, 16-QAM or 32-QAM modulated bursts. 8-PSK, QPSK, 16-QAM and 32-QAM modulation and the 8-PSK, QPSK, 16-QAM and 32-QAM normal bursts are defined in 3GPP TS 45.004 clause 3 and 3GPP TS 45.002 subclause 5.2.3, respectively.
- The measurement accuracy of the LMU is defined as the root-mean-square (RMS) value of 90% of the measurements that result in the least E-OTD error. As an example, if $\{x_1..x_N\}$ is a set of the absolute square E-OTD measurement errors for N trials, sorted in ascending order, the RMS of 90% is defined as:

$$\text{RMS}_{90} = \text{sqrt}(\text{sum}(x_1..x_M)/M)$$

where M is the largest integer such that $M < 0,9 N$. For the test, $N > 250$ trials is recommended. The channels shall be static, i.e. at a constant signal level throughout the measurements.

Table H.2-1: Reference Sensitivity Level

Signal strength at antenna connector	
GSM 400, GSM850, GSM 900, DCS 1800, PCS 1900	-110 dBm

**Table H.2-2: Sensitivity performance
(RMS₉₀ of E-OTD error in microseconds)**

Minimum neighbour carrier signal strength relatively to E-OTD LMU reference sensitivity level (Table H.2-1)	Static channel
0 dB	0.3 μs
20 dB	0.1 μs

H.2.2.2 Interference Performance

This clause defines E-OTD measurement accuracy (in microseconds) for specified carrier-to-interference ratios of the neighbor BCCH carrier. The reference BCCH carrier is as defined in subclause H.2.2.1. The neighbour BCCH carrier shall be as defined in H.2.2.1 and shall be set to a level 28 dB above the reference sensitivity level defined in table H.2-1. The C/I requirements shall be met for an interference signal which is co-channel, adjacent channel (200 kHz offset), and alternate channel (400 kHz offset) to the desired neighbour BCCH carrier as shown in table H.2-3.

- The interference signal consists of a random, continuous GMSK modulated signal.

**Table H.2-3: Interference performance
(RMS₉₀ of E-OTD error in microseconds)**

Interference type	Static channel	Minimum carrier to Interference Level (dB)
Co-channel	0.3 μs	0 dB
	0.1 μs	10 dB
Adjacent channel (200 kHz)	0.5 μs	-18 dB
	0.2 μs	-8 dB
Adjacent channel (400 kHz)	0.1 μs	-41dB

H.2.2.3 Multipath Performance

This clause defines E-OTD measurement accuracy under multipath conditions. The test setup is as under subclause H.2.2.1 (sensitivity performance) with the following changes:

- Each burst of the neighbour BCCH carrier propagates through the TU multipath channel specified in annex C of 3GPP TS 45.005. The reference carrier remains static.

The performance requirements are specified in table H.2-4.

**Table H.2-4: Multipath performance
(RMS₉₀ of E-OTD error in microseconds)**

Minimum neighbour carrier signal strength relative to reference sensitivity (Table H.2-1)	TU3 (12 tap setting)
0 dB	1,5 μ s

Annex I (normative): E-OTD Mobile Station Requirements

I.1 Introduction

To measure Enhanced Observed Timing Difference (E-OTD) location the MS must make accurate Observed-Time-Difference measurements (OTD - the time interval that is observed by a MS between the reception of signals (bursts) from two BTSs). Specifically, the E-OTD MS shall be capable of measuring the reception of bursts transmitted from a BTS on a periodic and predictable basis. The measurement results are used by the system or the E-OTD capable MS for determining location of the MS. This clause defines E-OTD measurement accuracy requirements of an E-OTD capable MS deployed in the GSM System. Requirements for dedicated mode E-OTD measurements are specified below. An E-OTD MS, supporting the MS based E-OTD method, shall be capable of doing idle mode E-OTD measurements with the same accuracy as in dedicated mode, but this needs not to be tested.

I.2 Sensitivity and Interference Performance

This clause specifies the required E-OTD measurement accuracy for an E-OTD capable MS with and without interference. The requirements are given in terms of E-OTD measurement error (in microseconds), as function of the carrier and interference input power levels, at the antenna connector of the receiver. Equipment with an integral antenna may be taken into account in a similar manner as described in Chapter 5 of 3GPP TS 45.005.

The power level, under multipath fading condition, is the mean power of the sum of the individual paths.

I.2.1 Sensitivity Performance

With the following configuration and propagation conditions, the E-OTD capable MS shall meet the requirements of 90% RMS E-OTD error defined in Table I.2-1.

- The E-OTD capable MS is in dedicated mode receiving a carrier signal at a power level of at least 20 dB above the reference sensitivity level defined in subclause 6.2.
- The E-OTD measurements are done on a neighbour BCCH carrier at power levels relative to the reference sensitivity level defined in subclause 6.2. The measurement power levels are given in Table I.2-1. The E-OTD measurements are referenced to a reference BCCH carrier at a power level at least 20 dB above the reference sensitivity level defined in subclause 6.2. The reference BCCH carrier and the neighbour BCCH carrier shall be in the same frequency band. The BA list contains the reference BCCH carrier and the neighbour BCCH carrier.
- The network requests an E-OTD measurement by commanding the E-OTD capable MS to report the E-OTD measurement with a response time equal to 2 seconds. The E-OTD capable MS does not need to perform E-OTD measurements prior to receiving the command.
- The measurement performance shall also be achieved with the reference BCCH and the neighbour BCCH carriers having 8-PSK modulated bursts. 8-PSK modulation and the 8-PSK normal bursts are defined in 3GPP TS 45.004 clause 3 and 3GPP TS 45.002 subclause 5.2.3, respectively.
- The measurement accuracy of the E-OTD capable MS is defined as the root-mean-square (RMS) value of 90% of the measurements that result in the least E-OTD error. As an example, if $\{x_1..x_N\}$ is a set of the absolute square E-OTD measurement errors for N trials, sorted in ascending order, the RMS of 90% is defined as

$$\text{RMS}_{90} = \text{sqrt}(\text{sum}(x_1..x_M)/M)$$

where M is the largest integer such that $M < 0.9 N$. For the test, $N > 250$ trials is recommended.

The channels shall be static, i.e. at a constant signal level throughout the measurements.

**Table I.2-1: Sensitivity performance
(RMS₉₀ of E-OTD error in microseconds)**

Minimum neighbour carrier signal strength relative to reference sensitivity level	Static channel
-8 dB	0.3 μs
12 dB	0.1 μs

1.2.2 Interference Performance

In this clause, requirements are given in terms of the E-OTD measurement accuracy (in microseconds) for specified carrier-to-interference ratios of the neighbour BCCH carrier. The carrier the MS uses for communication and the reference BCCH carrier shall be as defined in section I.2.1. The input neighbour BCCH carrier signal shall be as defined in I.2.1 and shall be set to a level at least 20 dB above the reference sensitivity signal level defined in subclause 6.2. The C/I requirements shall be met for an interference signal which is co-channel, adjacent channel (200 kHz offset), and alternate channel (400 kHz offset) to the desired neighbour BCCH carrier as shown in Table I.2-2 below.

- The interference signal consists of a random, continuous GMSK modulated signal.

**Table I.2-2: Interference performance
(RMS₉₀ of E-OTD error in microseconds)**

Interference type	Static Channel	Minimum carrier to Interference Level (dB)
Co-channel	0.3 μs	0 dB
	0.1 μs	10 dB
Adjacent channel (200 kHz)	0.5 μs	-18 dB
	0.2 μs	-8 dB
Adjacent channel (400 kHz)	0.1 μs	-41 dB

1.2.3 Multipath Performance

This clause defines E-OTD measurement accuracy under multipath conditions. The test setup is as under I.2.1 (sensitivity performance) with the following changes:

- Each burst of the neighbour BCCH carrier propagates through the TU multipath channel specified in Annex C of 3GPP TS 45.005. The reference carrier remains static.

The performance requirements are specified in Table I.2-3.

**Table I.2-3: Multipath performance
(RMS₉₀ of E-OTD error in microseconds)**

Minimum neighbour carrier signal strength relative to reference sensitivity	TU3 (12 tap setting)
-8 dB	1.5 μs

Annex J (informative): Guidance on the Usage of Dynamic ARFCN Mapping

J.1 Introduction

Dynamic mapping of ARFCN numbers may be used in order to extend the capability to support more frequencies than with a fixed allocation scheme which is limited to 1024 frequencies. Typically dynamic mapping would be used for ARFCN numbers that have no fixed allocation as described in section 2 but dynamic allocation of other ARFCN numbers is also possible.

Mapping of ARFCN numbers to frequencies may be indicated in System Information type 14, type 15 or Packet System Information Type 8. This mapping may be limited to the actual frequency allocation used by the serving PLMN or additionally to frequencies of other PLMNs in case of co-operation between different PLMNs allowing e.g. handover between those PLMNs.

J.2 Dynamic allocation of GSM 400, GSM 800, GSM 900, DCS 1800 and PCS 1900 ARFCNs

If a PLMN is not using some of frequencies of GSM 400, GSM 800, GSM 900, DCS 1800 or PCS 1900 bands, the corresponding ARFCN numbers may be used for dynamic ARFCN mapping. However, in this case mobiles of previous releases, not supporting dynamic ARFCN mapping but supporting the frequency band concerned, monitor different frequencies than actually intended. In this case the operator must take care that NCC_PERMITTED (See 3GPP TS 44.018) is set in a way that those mobiles ignore unintentional measurements, based on NCC not permitted. Note that in this case a mobile station not supporting dynamic mapping, performs the same number of RXLEV measurements per measurement report per carrier on the BA as the mobile station that supports dynamic mapping. However, some loss of performance may occur when the mobile station is searching synchronisation for carriers on the list of strongest cells.

J.3 Controlling changes in dynamic mapping

Dynamic mapping may need to be changed in a live network e.g. when the operator is taking new frequency allocations into use or if the existing frequency allocation is changed. Since the mobile stations decode the information about dynamic mapping periodically only in idle mode, valid mapping must be broadcast well before the new mapping is taken into use.

An example case of a change in dynamic mapping is described by the following steps:

- Assume that the network is initially broadcasting dynamic mapping for 4 different frequency blocks, referred as DM1, DM2, DM3 and DM4.
- Assume that DM1 is covering the frequency range from x to $x + 5$ MHz and the frequency band allocated for the operator is changed to the range from $x - 5$ MHz to $x + 2$ MHz (extension and change of frequency allocation at the same time).
- The operator should then start to broadcast a new dynamic mapping DM1, DM2, DM3, DM4 and DM5 where the old frequency allocation is mapped by DM1 and the new allocation is mapped by DM5. *The requirement is that the ARFCN numbers used for DM1 and DM5 are non-overlapping.*
- Once the operator has used this new system information sufficiently long, the change in the frequency allocation can be carried out. Note that this change needs to be done like any similar change with fixed mapping scheme, the change should occur simultaneously for all active resources in a given cell, including likely changes in neighbour cell SI messages.
- At any time after the actual change in the frequency allocation, the operator may start broadcasting dynamic mapping excluding DM1, i.e. including only DM5, DM2, DM3 and DM4.

Transmission of duplicated mapping information (DM1 & DM5 in the above example) should last as long as the longest supported continuous call at the time the change in mapping takes place. This allows all mobiles decode the new mapping information in idle mode. Alternatively the network may provide the new mapping information in dedicated mode through SACCH with System Information type 14 message. This option allows infinite calls and reduces the time required for broadcasting of duplicated mapping information.

Annex K (normative): Reference TFCs for FLO

In all reference TFCs, the TFCI shall be random.

For each reference TFC, the size of the uncoded in-band signalling bits shall be set equal to the size of the uncoded TFCI for that TFC.

Reference TFC 1: "Signalling (9.2 kbit/s) on GMSK FR channel"

	TrCH 1
TB size	184
CRC	18
RMA	256
Channel mode	FR
Modulation	GMSK
Interleaving	40 ms
TFCI	5 bits

Reference TFC 2: "Low bit-rate codec (5 kbit/s) on GMSK HR channel"

	TrCH 1	TrCH 2
TB size	50	50
CRC	6	0
RMA	256	226
Channel mode	HR	
Modulation	GMSK	
Interleaving	40 ms	
TFCI	2 bits	

Reference TFC 3: "Medium bit-rate codec (10 kbit/s) on GMSK FR channel"

	TrCH 1	TrCH 2
TB size	100	100
CRC	6	0
RMA	256	226
Channel mode	FR	
Modulation	GMSK	
Interleaving	40 ms	
TFCI	3 bits	

Reference TFC 4: "Medium bit-rate codec (10 kbit/s) on 8PSK HR channel"

	TrCH 1	TrCH 2
TB size	100	100
CRC	6	0
RMA	256	226
Channel mode	HR	
Modulation	8PSK	
Interleaving	40 ms	
TFCI	4 bits	

Reference TFC 5: "High bit-rate codec (20 kbit/s) on 8PSK FR channel"

	TrCH 1	TrCH 2
TB size	200	200
CRC	6	0
RMA	256	226
Channel mode	FR	
Modulation	8PSK	
Interleaving	40 ms	
TFCI	5 bits	

Reference TFC 6: "Multiple transport blocks (30 kbit/s) on 8PSK FR channel"

	TrCH 1	TrCH 2	TrCH 3	TrCH 4
TB size	150	150	150	150
CRC	12	12	12	12
RMA	256	256	256	256
Channel mode	FR			
Modulation	8PSK			
Interleaving	20 ms			
TFCI	5 bits			

Reference TFC 7: "High bit-rate data (50 kbit/s) on 8PSK FR channel"

	TrCH 1
TB size	1000
CRC	18
RMA	256
Channel mode	FR
Modulation	8PSK
Interleaving	20 ms
TFCI	1 bit

Annex L (normative): Reference Test Scenarios for DARP

In all reference DARP Test Scenarios (DTS), the wanted signal shall always use Training Sequence (TSC) 0.

In each reference Test Scenario, the co-channel and adjacent channel interferers are GMSK modulated. The power of these interferers is measured before any receiver filtering and during the active part of the desired burst (see 3GPP TS 45.004). The use of Training sequence for the interferers varies between the Test Scenarios as defined below. When no TSC is indicated the midamble is filled with random data bits. Random TSC means that TSC is randomly selected on a burst-by-burst basis from {TSC1,...,TSC7}.

In some test scenarios an AWGN source is added to the interferers. The AWGN power is measured over a bandwidth of 270,833 kHz.

All power levels are relative to the signal level of the strongest co-channel interferer.

Power ramping according to the requirements in 3GPP TS 45.005 shall be applied to all delayed interferers. The other interferers shall be random, continuous GMSK-modulated signals.

NOTE: The non-delayed interferer is the same signal for which reference interference performance requirements normally apply (see clause 6.3).

In adjacent timeslots of the delayed interferers no power shall be applied.

The level of the strongest co-channel interferer (Co-channel 1) shall be -80 dBm.

The delay is measured from the same bit position in the wanted signal burst and the interferer burst, where the position in the wanted signal is the reference position.

Reference Test Scenario for synchronous single co-channel interferer

Reference Test Scenario	Interfering Signal	Interferer relative power level	TSC	Interferer Delay range
DTS-1	Co-channel 1	0 dB	none	no delay

Reference Test Scenarios for synchronous multiple interferers

Reference Test Scenario	Interfering Signal	Interferer relative power level	TSC	Interferer Delay range
DTS-2	Co-channel 1	0 dB	none	no delay
	Co-channel 2	-10 dB	none	no delay
	Adjacent 1	3 dB	none	no delay
	AWGN	-17 dB	-	-
DTS-3	Co-channel 1	0 dB	random	-1 to +4 symbols ^{*)}
	Co-channel 2	-10 dB	none	no delay
	Adjacent 1	3 dB	none	no delay
	AWGN	-17 dB	-	-

^{*)} The delay shall be an integer number of symbols, arbitrarily chosen within the given interval and fixed throughout each test case.

Reference Test Scenario for asynchronous single co-channel interferer

Reference Test Scenario	Interfering Signal	Interferer relative power level	TSC	Interferer Delay
DTS-4	Co-channel 1	0 dB ^{*)}	none	74 symbols

^{*)} The power of the delayed interferer burst, averaged over the active part of the wanted signal burst. The power of the delayed interferer burst, averaged over the active part of the delayed interferer burst is 3 dB higher.

Reference Test Scenario for asynchronous multiple interferers

Reference Test Scenario	Interfering Signal	Interferer relative power level	TSC	Interferer Delay
DTS-5	Co-channel 1	0 dB ^{*)}	none	74 symbols
	Co-channel 2	-10 dB	none	no delay
	Adjacent 1	3 dB	none	no delay
	AWGN	-17 dB	-	-

^{*)} The power of the delayed interferer burst, averaged over the active part of the wanted signal burst. The power of the delayed interferer burst, averaged over the active part of the delayed interferer burst is 3 dB higher.

Annex M (normative): Minimum Performance Requirements for Assisted Global Positioning System (A-GPS)

This Annex defines the minimum performance requirements for A-GPS for MSs that support A-GPS. It includes the minimum performance requirements for both MS based and MS assisted A-GPS terminals.

M.1 General

M.1.1 Abbreviations

A-GPS	Assisted - Global Positioning System
C/A	Coarse/Acquisition
ECEF	Earth Centred, Earth Fixed
GPS	Global Positioning System
HDOP	Horizontal Dilution Of Precision
LOS	Line Of Sight
TOW	Time Of Week
TTFP	Time To First Fix
WLS	Weighted Least Squares

M.1.2 Measurement parameters

M.1.2.1 MS based A-GPS measurement parameters

In case of MS-based A-GPS, the measurement parameters are contained in the RRLP LOCATION INFORMATION IE. The measurement parameter in case of MS-based A-GPS is the horizontal position estimate reported by the MS and expressed in latitude/longitude.

M.1.2.2 MS assisted A-GPS measurement parameters

In case of MS-assisted A-GPS, the measurement parameters are contained in the RRLP GPS MEASUREMENT INFORMATION IE. The measurement parameters in case of MS-assisted A-GPS are the MS GPS Code Phase measurements. The MS GPS Code Phase measurements are converted into a horizontal position estimate using the procedure detailed in clause M.7.

M.1.3 Response time

Max Response Time is defined as the time starting from the moment that the MS has received the final RRLP MEASURE POSITION REQUEST sent before the MS sends the MEASURE POSITION RESPONSE containing the Location Information or the GPS Measurement Information, and ending when the MS starts sending the MEASURE POSITION RESPONSE containing the Location Information or the GPS Measurement Information on the Air interface. The response times specified for all test cases are Time-to-First-Fix (TTFP), i.e. the MS shall not re-use any information on GPS time, location or other aiding data that was previously acquired or calculated and stored internally in the MS. A dedicated test message 'RESET MS POSITIONING STORED INFORMATION' has been defined in TS 44.014 for the purpose of deleting this information and is detailed in subclause M.3.1.10.

M.1.4 Time assistance

Time assistance is the provision of GPS time to the MS from the network via RRLP messages. Currently two different GPS time assistance methods can be provided by the network.

- a) Coarse time assistance is always provided by the network and provides current GPS time to the MS. The time provided is within ± 2 seconds of GPS system time. This allows the GPS time to be known within one GPS navigation data sub-frame. It is signalled to the MS by means of the GPS Week and GPS TOW fields in the Reference Time assistance data IE.
- b) Fine time assistance is optionally provided by the network and adds the provision to the MS of the relationship between the GPS system time and the current GSM time. The accuracy of this relationship is $\pm 10 \mu\text{s}$ of the actual relationship. This addresses the case when the network can provide an improved GPS time accuracy. It is signalled to the MS by means of the FNm, TN and BN fields in the Reference Time assistance data IE.

The time of applicability of time assistance is the beginning of the Frame of the message containing the GPS Reference time.

M.1.4.1 Use of fine time assistance

The use of fine time assistance to improve the GPS performance of the MS is optional for the MS, even when fine time assistance is signalled by the network. Thus, there are a set minimum performance requirements defined for all MSs and additional minimum performance requirements that are valid for fine time assistance capable MSs only. These requirements are specified in subclause M.2.1.2.

M.1.4.2 2D position error

The 2D position error is defined by the horizontal difference in meters between the ellipsoid point reported or calculated from the MS MEASURE POSITION RESPONSE and the actual position of the MS in the test case considered.

M.2 A-GPS minimum performance requirements

The A-GPS minimum performance requirements are defined by assuming that all relevant and valid assistance data is received by the MS in order to perform GPS measurements and/or position calculation. This clause does not include nor consider delays occurring in the various signalling interfaces of the network.

In the following subclauses the minimum performance requirements are based on availability of the assistance data information and messages defined in clauses M.5 and M.6.

M.2.1 Sensitivity

A sensitivity requirement is essential for verifying the performance of A-GPS receiver in weak satellite signal conditions. In order to test the most stringent signal levels for the satellites the sensitivity test case is performed in AWGN channel. This test case verifies the performance of the first position estimate, when the MS is provided with only coarse time assistance and when it is additionally supplied with fine time assistance.

M.2.1.1 Coarse time assistance

In this test case 8 satellites are generated for the terminal. AWGN channel model is used.

Table M.2-1: Test parameters

Parameters	Unit	Value
Number of generated satellites	-	8
HDOP Range	-	1.1 to 1.6
Propagation conditions	-	AWGN
GPS Coarse time assistance error range	seconds	± 2
GPS Signal for one satellites	dBm	-142
GPS Signal for remaining satellites	dBm	-147

M.2.1.1.1 Minimum Requirements (Coarse time assistance)

The position estimates shall meet the accuracy and response time specified in table M.2-2.

Table M.2-2: Minimum requirements (coarse time assistance)

Success rate	2-D position error	Max response time
95 %	100 m	20 s

M.2.1.2 Fine time assistance

This requirement is only valid for fine time assistance capable MSs. In this requirement 8 satellites are generated for the terminal. AWGN channel model is used.

Table M.2-3: Test parameters for fine time assistance capable terminals

Parameters	Unit	Value
Number of generated satellites	-	8
HDOP Range	-	1.1 to 1.6
Propagation conditions	-	AWGN
GPS Coarse time assistance error range	seconds	± 2
GPS Fine time assistance error range	μs	± 10
GPS Signal for all satellites	dBm	-147

M.2.1.2.1 Minimum Requirements (Fine time assistance)

The position estimates shall meet the accuracy and response time requirements in table M.2-4.

Table M.2-4: Minimum requirements for fine time assistance capable terminals

Success rate	2-D position error	Max response time
95 %	100 m	20 s

M.2.2 Nominal Accuracy

Nominal accuracy requirement verifies the accuracy of A-GPS position estimate in ideal conditions. The primary aim of the test is to ensure good accuracy for a position estimate when satellite signal conditions allow it. This test case verifies the performance of the first position estimate.

In this requirement 8 satellites are generated for the terminal. AWGN channel model is used.

Table M.2-5: Test parameters

Parameters	Unit	Value
Number of generated satellites	-	8
HDOP Range	-	1.1 to 1.6
Propagation conditions	-	AWGN
GPS Coarse time assistance error range	seconds	± 2
GPS Signal for all satellites	dBm	-130

M.2.2.1 Minimum requirements (nominal accuracy)

The position estimates shall meet the accuracy and response time requirements in table M.2-6.

Table M.2-6: Minimum requirements

Success rate	2-D position error	Max response time
95 %	30 m	20 s

M.2.3 Dynamic Range

The aim of a dynamic range requirement is to ensure that a GPS receiver performs well when visible satellites have rather different signal levels. Strong satellites are likely to degrade the acquisition of weaker satellites due to their cross-correlation products. Hence, it is important in this test case to keep use AWGN in order to avoid loosening the requirements due to additional margin because of fading channels. This test case verifies the performance of the first position estimate.

In this requirement 6 satellites are generated for the terminal. AWGN channel model is used.

Table M.2-7: Test parameters

Parameters	Unit	Value
Number of generated satellites	-	6
HDOP Range	-	1.4 to 2.1
GPS Coarse time assistance error range	seconds	± 2
Propagation conditions	-	AWGN
GPS Signal for 1 st satellite	dBm	-129
GPS Signal for 2 nd satellite	dBm	-135
GPS Signal for 3 rd satellite	dBm	-141
GPS Signal for 4 th satellite	dBm	-147
GPS Signal for 5 th satellite	dBm	-147
GPS Signal for 6 th satellite	dBm	-147

M.2.3.1 Minimum requirements (dynamic range)

The position estimates shall meet the accuracy and response time requirements in table M.2-8.

Table M.2-8: Minimum requirements

Success rate	2-D position error	Max response time
95 %	100 m	20 s

M.2.4 Multi-Path scenario

The purpose of the test case is to verify the receiver's tolerance to multipath while keeping the test setup simple. This test case verifies the performance of the first position estimate.

In this requirement 5 satellites are generated for the terminal. Two of the satellites have one tap channel representing Line-Of-Sight (LOS) signal. The three other satellites have two-tap channel, where the first tap represents LOS signal and the second reflected and attenuated signal as specified in Case G1 in subclause M.4.2.

Table M.2-9: Test parameters

Parameters	Unit	Value
Number of generated satellites (Satellites 1, 2 unaffected by multi-path) (Satellites 3, 4, 5 affected by multi-path)	-	5
GPS Coarse time assistance error range	seconds	±2
HDOP Range	-	1.8 to 2.5
Satellite 1, 2 signal	dBm	-130
Satellite 3, 4, 5 signal	dBm	LOS signal of -130 dBm, multi-path signal of -136 dBm

M.2.4.1 Minimum Requirements (multi-path scenario)

The position estimates shall meet the accuracy and response time requirements in table M.2-10.

Table M.2-10: Minimum requirements

Success rate	2-D position error	Max response time
95 %	100 m	20 s

M.2.5 Moving scenario and periodic location

This test case only applies to MSs supporting Rel-7 or later Supplementary Services.

The purpose of the test case is to verify the receiver's capability to produce GPS measurements or location fixes on a regular basis, and to follow when it is located in a vehicle that slows down, turns or accelerates. A good tracking performance is essential for a certain location services. A moving scenario with periodic location is well suited for verifying the tracking capabilities of an A-GPS receiver in changing MS speed and direction. In the requirement the MS moves on a rectangular trajectory, which imitates urban streets. AWGN channel model is used. This test is not performed as a Time to First Fix (TTFF) test.

In this requirement 5 satellites are generated for the terminal. The MS is requested to use periodic location reporting with a reporting interval of 2 seconds.

The MS moves on a rectangular trajectory of 940 m by 1 440 m with rounded corner defined in figure M.2-1. The initial reference is first defined followed by acceleration to final speed of 100 km/h in 250 m. The MS then maintains the speed for 400 m. This is followed by deceleration to final speed of 25 km/h in 250 m. The MS then turn 90 degrees with turning radius of 20 m at 25 km/h. This is followed by acceleration to final speed of 100 km/h in 250 m. The sequence is repeated to complete the rectangle.

Table M.2-11: Trajectory Parameters

Parameter	Distance (m)	Speed (km/h)
$l_{11}, l_{15}, l_{21}, l_{25}$	20	25
$l_{12}, l_{14}, l_{22}, l_{24}$	250	25 to 100 and 100 to 25
l_{13}	400	100
l_{23}	900	100

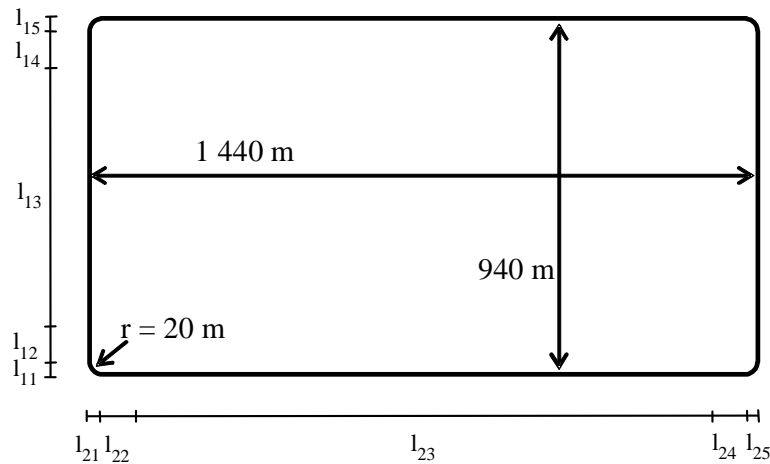

Figure M.2-1: Rectangular trajectory of the moving scenario and periodic location test case

Table M.2-12: Test Parameters

Parameters	Unit	Value
Number of generated satellites	-	5
HDOP Range	-	1.8 to 2.5
Propagation condition	-	AWGN
GPS signal for all satellites	dBm	-130

M.2.5.1 Minimum Requirements (moving scenario and periodic location)

The position estimates shall meet the accuracy requirement of table M.2-13 with the periodic location reporting interval defined in table M.2-13 after the first reported position estimates.

NOTE: In the actual testing the MS may report error messages until it has been able to acquire GPS measured results or a position estimate. The test equipment shall only consider the first measurement report different from an error message as the first position estimate in the requirement in table M.2-13.

Table M.2-13: Minimum requirements

Success Rate	2-D position error	Periodic location reporting interval
95 %	100 m	2 s

M.3 Test conditions

M.3.1 General

This clause specifies the additional parameters that are needed for the test cases specified in clause M.2 and applies to all tests unless otherwise stated.

M.3.1.1 Parameter values

Additionally, amongst all the listed parameters (see clause M.6), the following values for some important parameters are to be used in the MEASURE POSITION REQUEST message.

Table M.3-1: Parameter values

Information element	Value (except nominal accuracy test)	Value (nominal accuracy test)
Required Response Time	20s	20s
Accuracy	51.2 m	16 m

For the Moving scenario and periodic location test the following values for some important parameters are to be used in the REGISTER message.

Table M.3-2: Parameter values for Moving scenario and periodic location test

Information element	Value
Reporting Amount	To cover the required test time
Reporting Interval	2s

M.3.1.2 Time assistance

For every Test Instance in each test case, the IE GPS TOW shall have a random offset, relative to GPS system time, within the error range of Coarse Time Assistance defined in the test case. This offset value shall have a uniform random distribution.

In addition, for every Fine Time Assistance Test Instance the IE BN shall have a random offset, relative to the true value of the relationship between the two time references, within the error range of Fine Time Assistance defined in the test case. This offset value shall have a uniform random distribution.

M.3.1.3 GPS Reference Time

For every Test Instance in each test case, the GPS reference time shall be advanced so that, at the time the fix is made, it is at least 2 minutes later than the previous fix.

M.3.1.4 Reference and MS locations

There is no limitation on the selection of the reference location, consistent with achieving the required HDOP for the Test Case. For each test instance the reference location shall change sufficiently such that the MS shall have to use the new assistance data. The uncertainty of the semi-major axis is 3 km. The uncertainty of the semi-minor axis is 3 km. The orientation of major axis is 0 degrees. The uncertainty of the altitude information is 500 m. The confidence factor is 68 %.

For every Test Instance in each test case, the MS location shall be randomly selected to be within 3 km of the Reference Location. The Altitude of the MS shall be randomly selected between 0 m to 500 m above WGS-84 reference ellipsoid. These values shall have uniform random distributions.

M.3.1.5 Satellite constellation and assistance data

The satellite constellation shall consist of 24 satellites. Almanac assistance data shall be available for all these 24 satellites. At least 9 of the satellites shall be visible to the MS (that is above 5 degrees elevation with respect to the MS). Other assistance data shall be available for 9 of these visible satellites. In each test, signals are generated for only a sub-set of these satellites for which other assistance data is available. The number of satellites in this sub-set is specified in the test. The satellites in this sub-set shall all be above 15 degrees elevation with respect to the MS. The HDOP for the test shall be calculated using this sub-set of satellites. The selection of satellites for this sub-set shall be random and consistent with achieving the required HDOP for the test.

M.3.1.6 Atmospheric delays

Typical Ionospheric and Tropospheric delays shall be simulated and the corresponding values inserted into the Ionospheric Model IEs.

M.3.1.7 GSM Frequency and frequency error

In all test cases the GSM frequency used shall be the mid range for the GSM operating band. The GSM frequency with respect to the GPS carrier frequency shall be offset by +0.025 PPM.

M.3.1.8 Information elements

The information elements that are available to the MS in all the test cases are listed in clause M.6.

M.3.1.9 GPS signals

The GPS signal is defined at the A-GPS antenna connector of the MS. For MS with integral antenna only, a reference antenna with a gain of 0 dBi is assumed.

M.3.1.10 RESET MS POSITIONING STORED INFORMATION Message

In order to ensure each Test Instance in each test is performed under Time to First Fix (TTFF) conditions, a dedicated test signal (*RESET MS POSITIONING STORED INFORMATION*) defined in TS 44.014 shall be used.

When the MS receives the '*RESET MS POSITIONING STORED INFORMATION*' signal, with the IE *MS POSITIONING TECHNOLOGY* set to *AGPS* it shall:

- discard any internally stored GPS reference time, reference location, and any other aiding data obtained or derived during the previous test instance (e.g. expected ranges and Doppler);
- accept or request a new set of reference time or reference location or other required information, as in a TTFF condition;
- calculate the position or perform GPS measurements using the 'new' reference time or reference location or other information.

M.4 Propagation Conditions

M.4.1 Static propagation conditions

The propagation for the static performance measurement is an Additive White Gaussian Noise (AWGN) environment. No fading and multi-paths exist for this propagation model.

M.4.2 Multi-path Case G1

Doppler frequency difference between direct and reflected signal paths is applied to the carrier and code frequencies. The Carrier and Code Doppler frequencies of LOS and multi-path for GPS L1 signal are defined in table M.4-1.

Table M.4-1: Case G1

Initial relative Delay [GPS chip]	Carrier Doppler frequency of tap [Hz]	Code Doppler frequency of tap [Hz]	Relative mean Power [dB]
0	F_d	F_d / N	0
0.5	$F_d - 0.1$	$(F_d - 0.1) / N$	-6

NOTE: Discrete Doppler frequency is used for each tap.

$N = f_{\text{GPSL1}} / f_{\text{chip}}$, where f_{GPSL1} is the nominal carrier frequency of the GPS L1 signal (1575.42 MHz) and f_{chip} is the GPS L1 C/A code chip rate (1.023 Mchips/s).

The initial carrier phase difference between taps shall be randomly selected between $[0, 2\pi]$. The initial value shall have uniform random distribution.

M.5 Measurement sequence chart

M.5.1 General

The measurement Sequence Charts that are required in all the proposed test cases, are defined in this clause.

M.5.2 MS Based A-GPS Measurement Sequence Chart

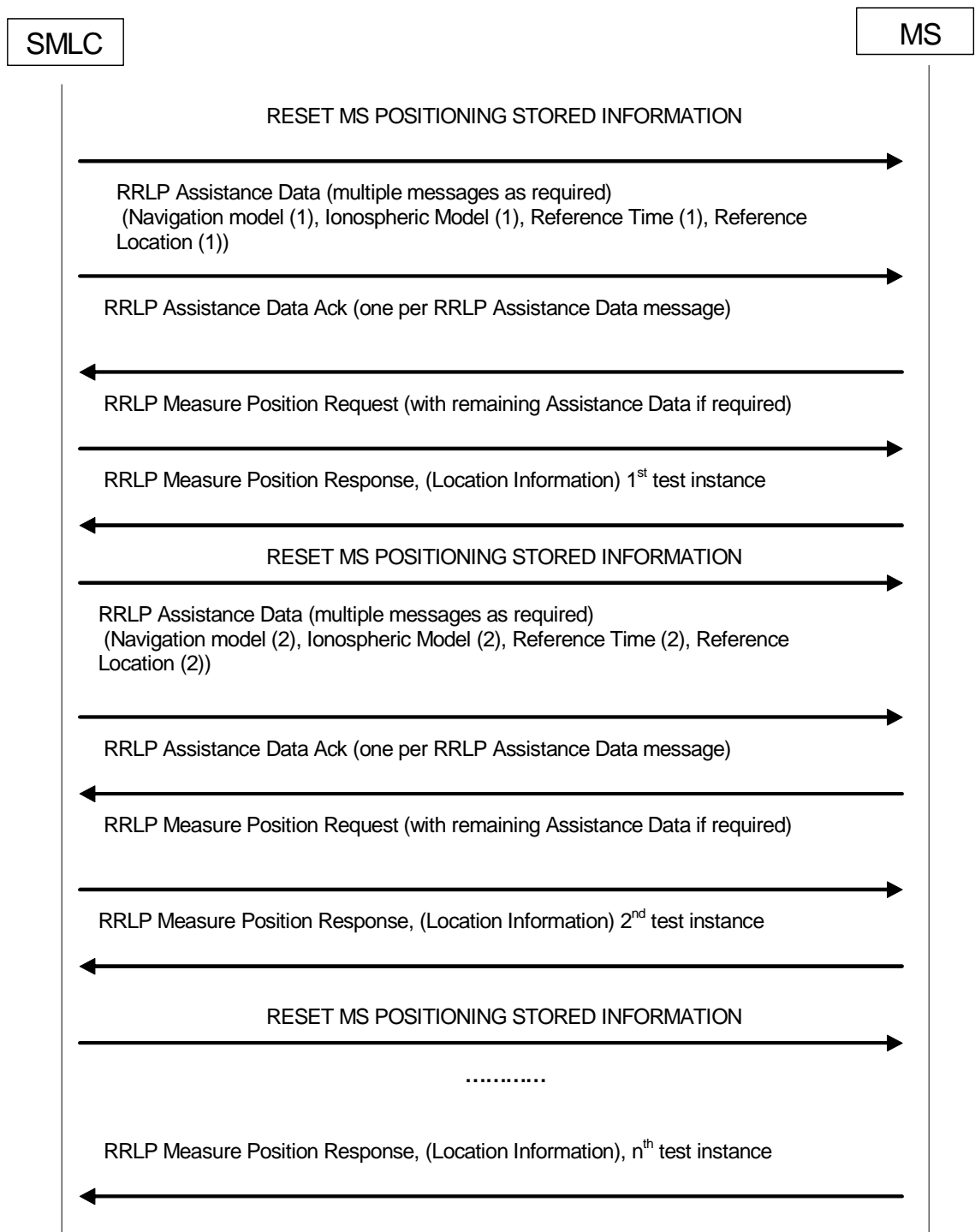

Figure M.5-1: MS-Based A-GPS Message Sequence

M.5.3 MS Assisted A-GPS Measurement Sequence Chart

The assistance data requested by the MS and provided by the SMLC in this sequence of messages shall be selected from among those information elements described as available in clause M.6.

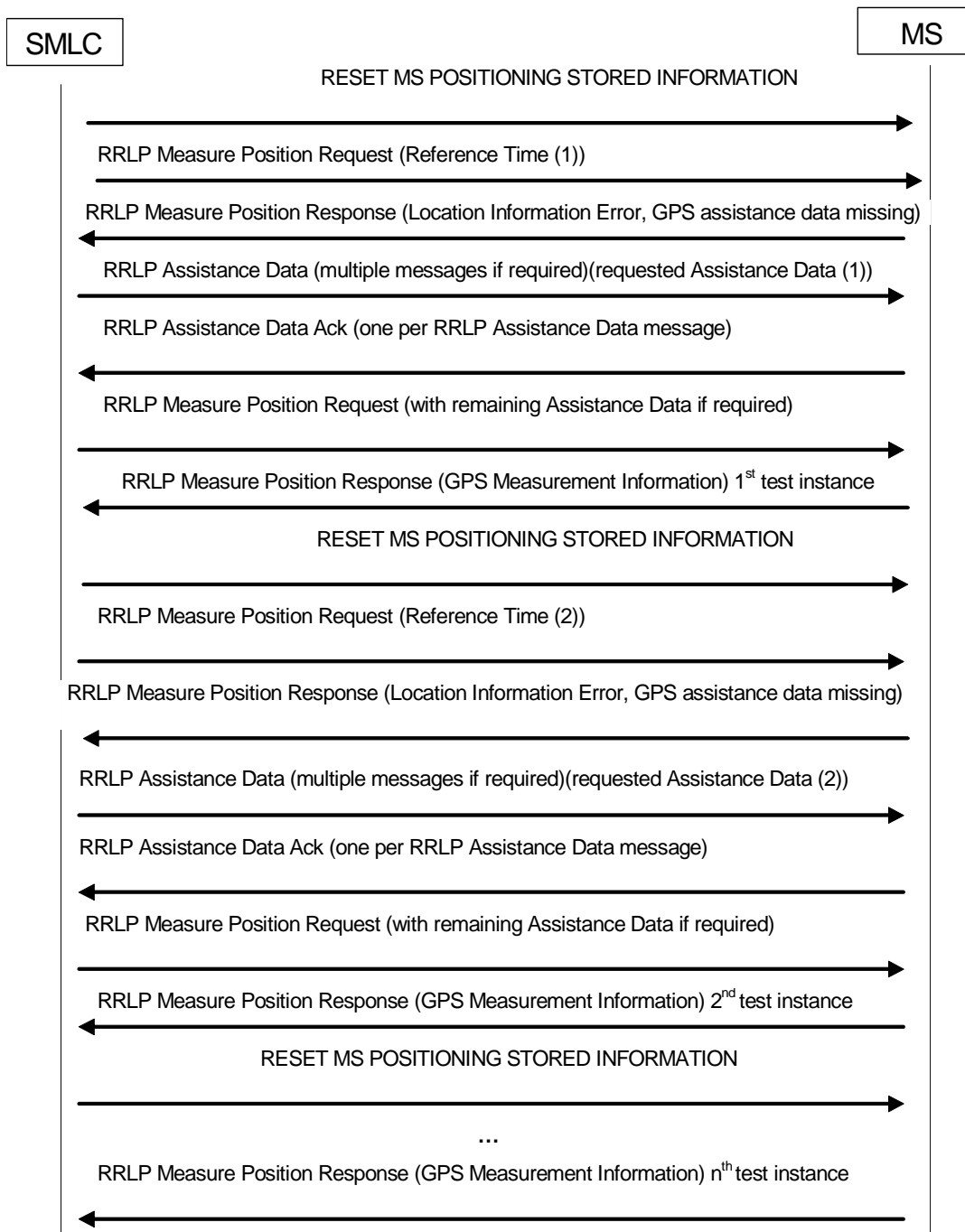

Figure M.5-2: MS-Assisted A-GPS Message Sequence

M.6 Assistance data required for testing

M.6.1 Introduction

This clause defines the assistance data IEs available in all test cases. The assistance data shall be given for satellites as defined in subclause M.3.1.5.

The information elements are given with reference to 3GPP TS 44.031, where the details are defined.

Subclause M.6.2 lists the assistance data IEs required for testing of MS-based mode, and subclause M.6.3 lists the assistance data available for testing of MS-assisted mode.

M.6.2 Information elements required for MS-based

The following GPS assistance data IEs shall be present for each test:

- a) **Reference Time IE.** This information element is defined in subclause A.4.2.4 of 3GPP TS 44.031.

Table M.6-1: Reference Time IE

Name of the IE	Fields of the IE	All tests except Sensitivity Fine Time Assistance	Sensitivity Fine Time Assistance test
Reference Time			
	GPS Week	Yes	Yes
	GPS TOW	Yes	Yes
	BCCH Carrier		Yes
	BSIC		Yes
	FNm		Yes
	TN		Yes
	BN		Yes
	GPS TOW Assist	Yes	Yes
	SatID	Yes	Yes
	TLM Message	Yes	Yes
	Anti-Spoof	Yes	Yes
	Alert	Yes	Yes
	TLM Reserved	Yes	Yes

- b) **Reference Location IE.** This information element is defined in subclause A.4.2.4 of 3GPP TS 44.031.

Table M.6-2: Reference Location IE

Name of the IE	Fields of the IE	All tests except Sensitivity Fine Time Assistance	Sensitivity Fine Time Assistance test
Reference Location	Ellipsoid point with Altitude and uncertainty ellipsoid	Yes	Yes

- c) **Navigation Model IE.** This information element is defined in subclause A.4.2.4 of 3GPP TS 44.031. The Navigation model will be chosen for the reference time and reference position.

Table M.6-3: Navigation Model IE

Name of the IE	Fields of the IE	All tests except Sensitivity Fine Time Assistance	Sensitivity Fine Time Assistance test
Navigation Model		Yes	Yes

- d) **Ionospheric Model IE.** This information element is defined in subclause A.4.2.4 of 3GPP TS 44.031.

Table M.6-4: Ionospheric Model IE

Name of the IE	Fields of the IE	All tests except Sensitivity Fine Time Assistance	Sensitivity Fine Time Assistance test
Ionospheric Model		Yes	Yes

M.6.3 Information elements available for MS-assisted

The following GPS assistance data IEs shall be available for each test:

- a) **Reference Time IE.** This information element is defined in subclause A.4.2.4 of 3GPP TS 44.031.

Table M.6-5: Reference Time IE

Name of the IE	Fields of the IE	All tests except Sensitivity Fine Time Assistance	Sensitivity Fine Time Assistance test
Reference Time			
	GPS Week	Yes	Yes
	GPS TOW	Yes	Yes
	BCCH Carrier		Yes
	BSIC		Yes
	FNm		Yes
	TN		Yes
	BN		Yes
	GPS TOW Assist	Yes	Yes
	SatID	Yes	Yes
	TLM Message	Yes	Yes
	Anti-Spoof	Yes	Yes
	Alert	Yes	Yes
	TLM Reserved	Yes	Yes

- b) **Reference Location IE.** This information element is defined in subclause A.4.2.4 of 3GPP TS 44.031.

Table M.6-6: Reference Location IE

Name of the IE	Fields of the IE	All tests except Sensitivity Fine Time Assistance	Sensitivity Fine Time Assistance test
Reference Location	Ellipsoid point with Altitude and uncertainty ellipsoid	Yes	Yes

- c) **Almanac IE** This information element is defined in subclause A.4.2.4 of 3GPP TS 44.031. The Almanac shall be chosen for the reference time.

Table M.6-7: Almanac IE

Name of the IE	Fields of the IE	All tests except Sensitivity Fine Time Assistance	Sensitivity Fine Time Assistance test
Almanac			
	Almanac Reference Week	Yes	Yes
	Satellite information	Yes	Yes

- d) **Navigation Model IE**. This information element is defined in subclause A.4.2.4 of 3GPP TS 44.031. The Navigation model will be chosen for the reference time and reference position.

Table M.6-8: Navigation Model IE

Name of the IE	Fields of the IE	All tests except Sensitivity Fine Time Assistance	Sensitivity Fine Time Assistance test
Navigation Model		Yes	Yes

- e) **Acquisition Assistance IE**. This information element is defined in subclause A.4.2.4 of 3GPP TS 44.031.

Table M.6-9: Acquisition Assistance IE

Name of the IE	Fields of the IE	All tests except Sensitivity Fine Time Assistance	Sensitivity Fine Time Assistance test
Acquisition Assistance			
	GPS TOW	Yes	Yes
	BCCH Carrier		Yes
	BSIC		Yes
	Frame #		Yes
	Timeslots #		Yes
	Bit #		Yes
	Satellite information	Yes	Yes
	SVID/PRNID	Yes	Yes
	Doppler (0 th order term)	Yes	Yes
	Doppler (1 st order term)	Yes	Yes
	Doppler Uncertainty	Yes	Yes
	Code Phase	Yes	Yes
	Integer Code Phase	Yes	Yes
	GPS Bit number	Yes	Yes
	Code Phase Search Window	Yes	Yes
	Azimuth	Yes	Yes
	Elevation	Yes	Yes

M.7 Converting MS-assisted measurement reports into position estimates

M.7.1 Introduction

To convert the MS measurement reports in case of MS-assisted mode of A-GPS into position errors, a transformation between the "measurement domain" (code-phases, etc.) into the "state" domain (position estimate) is necessary. Such a transformation procedure is outlined in the following clauses. The details can be found in [ICD-GPS 200], [P. Axelrad, R.G. Brown] and [S.K. Gupta].

M.7.2 MS measurement reports

In case of MS-assisted A-GPS, the measurement parameters are contained in the RRLP GPS MEASUREMENT INFORMATION ELEMENT (subclause A.3.2.5 in 3GPP TS 44.031). The measurement parameters required for calculating the MS position are:

- 1) Reference Time: The MS has two choices for the Reference Time:
 - a) "Reference Frame";
 - b) "GPS TOW ".
- 2) Measurement Parameters: 1 to <maxSat>:
 - a) "Satellite ID (SV PRN)";
 - b) "Whole GPS chips";
 - c) "Fractional GPS Chips";
 - d) "Pseudorange RMS Error".

Additional information required at the system simulator:

- 1) "Reference Location" (subclause A.4.2.4 in 3GPP TS 44.031):
Used for initial approximate receiver coordinates.
- 2) "Navigation Model" (subclause A.4.2.4 in 3GPP TS 44.031):
Contains the GPS ephemeris and clock correction parameters as specified in [ICD-GPS 200]; used for calculating the satellite positions and clock corrections.
- 3) "Ionospheric Model" (subclause A.4.2.4 in 3GPP TS 44.031):
Contains the ionospheric parameters which allow the single frequency user to utilize the ionospheric model as specified in [ICD-GPS 200] for computation of the ionospheric delay.

M.7.3 Weighted Least Squares (WLS) position solution

The WLS position solution problem is concerned with the task of solving for four unknowns; x_u , y_u , z_u the receiver coordinates in a suitable frame of reference (usually ECEF) and b_u the receiver clock bias. It typically requires the following steps:

Step 1: Formation of pseudo-ranges

The observation of code phase reported by the MS for each satellite SV_i is related to the pseudo-range/c modulo 1 ms (the length of the C/A code period). For the formation of pseudo-ranges, the integer number of milliseconds to be added to each code-phase measurement has to be determined first. Since 1 ms corresponds to a travelled distance of 300 km, the number of integer ms can be found with the help of reference location and satellite ephemeris. The distance between the reference location and each satellite SV_i is calculated and the integer number of milli-seconds to be added to the MS code phase measurements is obtained.

Step 2: Formation of weighting matrix

The MS reported "Pseudorange RMS Error" values are used to calculate the weighting matrix for the WLS algorithm described in [P. Axelrad, R.G. Brown]. According to 3GPP TS 44.031, the encoding for this field is a 6 bit value that consists of a 3 bit mantissa, X_i and a 3 bit exponent, Y_i for each SV_i :

$$w_i = RMSError = 0.5 \times \left(1 + \frac{X_i}{8} \right) \times 2^{Y_i}$$

The weighting Matrix \mathbf{W} is defined as a diagonal matrix containing the estimated variances calculated from the "Pseudorange RMS Error" values:

$$\mathbf{W} = \text{diag}\left\{1/w_1^2, 1/w_2^2, \dots, 1/w_n^2\right\}$$

Step 3: WLS position solution

The WLS position solution is described in [P. Axelrad, R.G. Brown] and usually requires the following steps:

- 1) Computation of satellite locations at time of transmission using the ephemeris parameters and user algorithms defined in [ICD-GPS 200] section 20.3.3.4.3.
- 2) Computation of clock correction parameters using the parameters and algorithms as defined in [ICD-GPS 200] section 20.3.3.3.3.1.
- 3) Computation of atmospheric delay corrections using the parameters and algorithms defined in [ICD-GPS 200] section 20.3.3.5.2.5 for the ionospheric delay, and using the Gupta model defined in [S.K. Gupta] p. 121 equation (2) for the tropospheric delay.
- 4) The WLS position solution starts with an initial estimate of the user state (position and clock offset). The Reference Location is used as initial position estimate. The following steps are required:
 - a) Calculate geometric range (corrected for Earth rotation) between initial location estimate and each satellite included in the MS measurement report.

- b) Predict pseudo-ranges for each measurement including clock and atmospheric biases as calculated in 1) to 3) above and defined in [ICD-GPS 200] and [P. Axelrad, R.G. Brown].
- c) Calculate difference between predicted and measured pseudo-ranges $\Delta\rho$
- d) Calculate the "Geometry Matrix" \mathbf{G} as defined in [P. Axelrad, R.G. Brown]:

$$\mathbf{G} \equiv \begin{bmatrix} -\hat{\mathbf{1}}_1^T & 1 \\ -\hat{\mathbf{1}}_2^T & 1 \\ \vdots & \vdots \\ -\hat{\mathbf{1}}_n^T & 1 \end{bmatrix} \text{ with } \hat{\mathbf{1}}_i \equiv \frac{\mathbf{r}_{si} - \hat{\mathbf{r}}_u}{|\mathbf{r}_{si} - \hat{\mathbf{r}}_u|} \text{ where } \mathbf{r}_{si} \text{ is the Satellite position vector for } SV_i \text{ (calculated in 1)}$$

above), and $\hat{\mathbf{r}}_u$ is the estimate of the user location.

- e) Calculate the WLS solution according to [P. Axelrad, R.G. Brown]:

$$\Delta\hat{\mathbf{x}} = (\mathbf{G}^T \mathbf{W} \mathbf{G})^{-1} \mathbf{G}^T \mathbf{W} \Delta\rho$$

- f) Adding the $\Delta\hat{\mathbf{x}}$ to the initial state estimate gives an improved estimate of the state vector:

$$\hat{\mathbf{x}} \rightarrow \hat{\mathbf{x}} + \Delta\hat{\mathbf{x}}.$$

- 5) This new state vector $\hat{\mathbf{x}}$ can be used as new initial estimate and the procedure is repeated until the change in $\hat{\mathbf{x}}$ is sufficiently small.

Step 4: Transformation from Cartesian coordinate system to Geodetic coordinate system

The state vector $\hat{\mathbf{x}}$ calculated in Step 3 contains the MS position in ECEF Cartesian coordinates together with the MS receiver clock bias. Only the user position is of further interest. It is usually desirable to convert from ECEF coordinates x_u, y_u, z_u to geodetic latitude φ , longitude λ and altitude h on the WGS84 reference ellipsoid.

Step 5: Calculation of "2-D Position Errors"

The latitude φ / longitude λ obtained after Step 4 is used to calculate the 2-D position error.

Annex N (normative): Reference Test Scenarios for DARP Phase II (MSRD)

N.1 Interferer configurations

In all reference DARP Test Scenarios (DTS), the wanted signal shall always use Training Sequence (TSC) 0.

In each reference Test Scenario, the co-channel and adjacent channel interferers are GMSK modulated, except for DTS-1b where the cochannel interferer is 8-PSK modulated. The power of the interferers is measured before any receiver filtering and during the active part of the desired burst (see 3GPP TS 45.004). No Training Sequence Code (TSC) is used, and thus the midamble is filled with random data bits.

In some test scenarios an AWGN source is added to the interferers. The AWGN power is measured over a bandwidth of 270,833 kHz.

All power levels are relative to the signal level of the strongest co-channel interferer.

Power ramping according to the requirements in 3GPP TS 45.005 shall be applied to all delayed interferers. The other interferers shall be random, continuous GMSK-modulated signals.

NOTE: The non-delayed interferer is the same signal for which reference interference performance requirements normally apply (see clause 6.3).

In adjacent timeslots of the delayed interferers no power shall be applied.

The level of the strongest co-channel interferer (Co-channel 1) shall be -70 dBm.

The delay is measured from the same bit position in the wanted signal burst and the interferer burst, where the position in the wanted signal is the reference position.

Table N.1-1 Reference Test Scenario for synchronous single co-channel interferer

Reference Test Scenario	Interfering Signal	Interferer relative power level	TSC	Interferer Delay range
DTS-1	Co-channel 1	0 dB	none	no delay
DTS-1b	Co-channel 1 8PSK	0 dB	none	no delay

Table N.1-2 Reference Test Scenarios for synchronous multiple interferers

Reference Test Scenario	Interfering Signal	Interferer relative power level	TSC	Interferer Delay range
DTS-2	Co-channel 1	0 dB	none	no delay
	Co-channel 2	-10 dB	none	no delay
	Adjacent 1	3 dB	none	no delay
	AWGN	-17 dB	-	-

Table N.1-3 Reference Test Scenario for asynchronous multiple interferers

Reference Test Scenario	Interfering Signal	Interferer relative power level	TSC	Interferer Delay
DTS-5	Co-channel 1	0 dB *)	none	74 symbols
	Co-channel 2	-10 dB	none	no delay
	Adjacent 1	3 dB	none	no delay
	AWGN	-17 dB	-	-

*) The power of the delayed interferer burst, averaged over the active part of the wanted signal burst. The power of the delayed interferer burst, averaged over the active part of the delayed interferer burst is 3 dB higher.

N.2 Correlation and antenna gain imbalance

Since a DARP phase II MS utilizes receiver diversity by means of two antennas, a set of diversity specific parameters have been defined. The sets consist of different values of antenna correlation and antenna gain imbalance.

Table N.2-1 DARP phase II diversity parameters

Parameter set	Antenna correlation, ρ	Antenna gain imbalance, G
Set 1	0	0 dB
Set 2	0.7	-6 dB

The correlation is defined as the magnitude of the complex correlation of the signals received at the two antenna connectors of the MS. A correlation value of 0 means the signals are uncorrelated. The antenna gain imbalance parameter reflects the difference in received signal level at the two antenna connectors. Thus, a value of -6 dB means that the signal on one antenna is attenuated by 6 dB compared to the signal on the other connector. The channel model setup when applying these parameters is illustrated below, where the parameter, G , models the antenna gain imbalance and ρ is the antenna correlation.

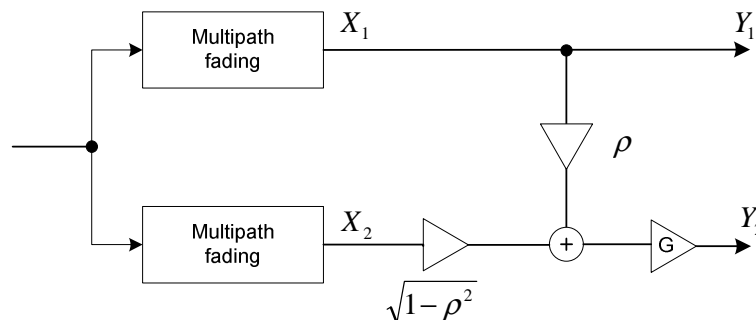

Figure N.2.1: Single input - dual output channel model for MS Receiver Diversity – DARP ph II

The model consists of a single input signal, which is passed through two fading channels. The multipath fading is independent Rayleigh fading processes but the channel profile, e.g. TU50 is the same for each branch. The correlation between the two branches is generated using the weighting factor, ρ , which as mentioned is the magnitude of the complex correlation. Antenna gain imbalance is applied by attenuating Y_1 or Y_2 by 6 dB as indicated by the G block on figure N.2.1.

The multi interferer scenarios (DTS-2 and DTS-5) are generated by expanding the single input-dual output model as shown below. The model uses instances of the single input dual output channel model to instantiate the interfering signals. For sensitivity tests the single input – dual output channel model of figure N.2.1 is sufficient.

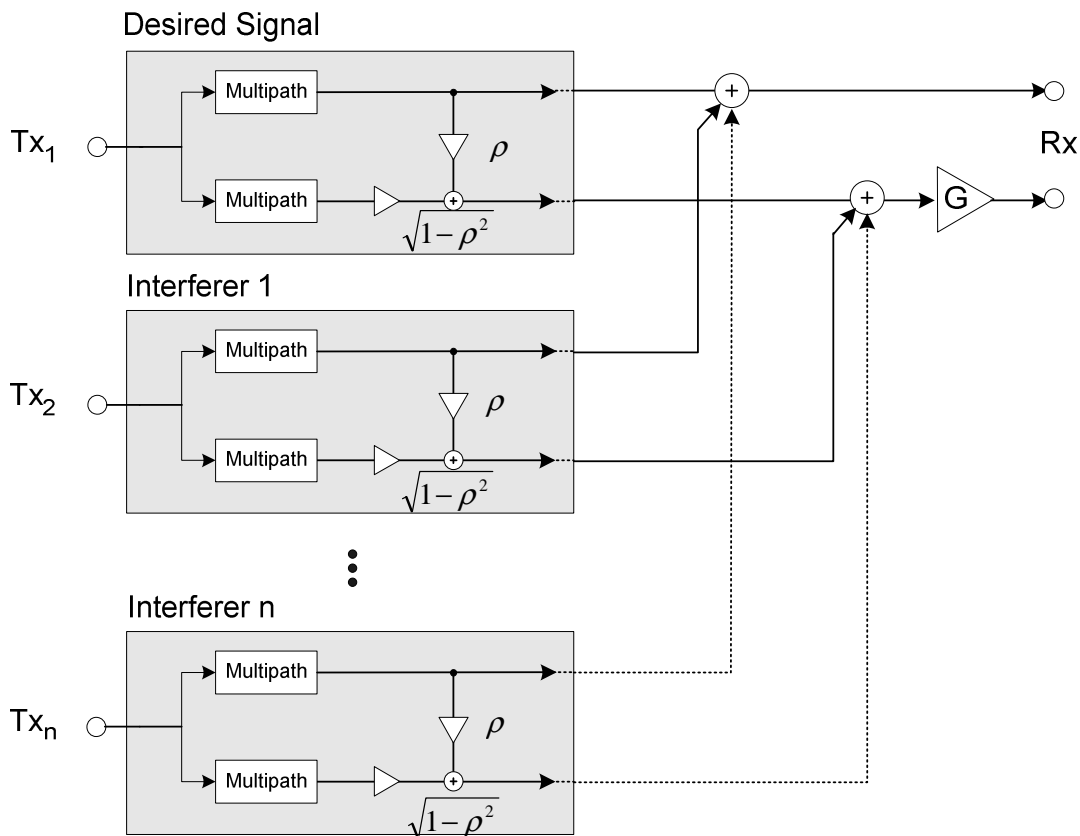

Figure N.2.2: Multi interferer model for MS Receiver Diversity – DARP ph II. The amplifier *G* represents the antenna gain imbalance parameter.

N.3 Testing MSRD terminal conformance to legacy requirements

When testing the conformance of a dual antenna terminal against the single antenna requirements the following procedures shall be applied.

- For an MS that always applies MSRD, conformance to legacy requirements shall be tested by applying uncorrelated signals to the antenna connectors. This corresponds to setting $\rho = 0$ and $G = 0$ in the model shown in figure N.2.1 and thus reduces the model to the one shown in figure N.3.1.
- For an MS capable of switching between single and dual antenna reception conformance shall be tested by terminating one of the antenna connectors, as shown in figure N.3.2.

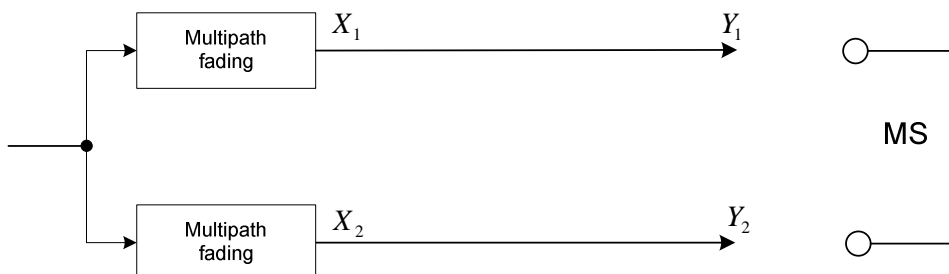

Figure N.3.1: Test setup when testing conformance to legacy requirements for MS having MSRD always enabled.

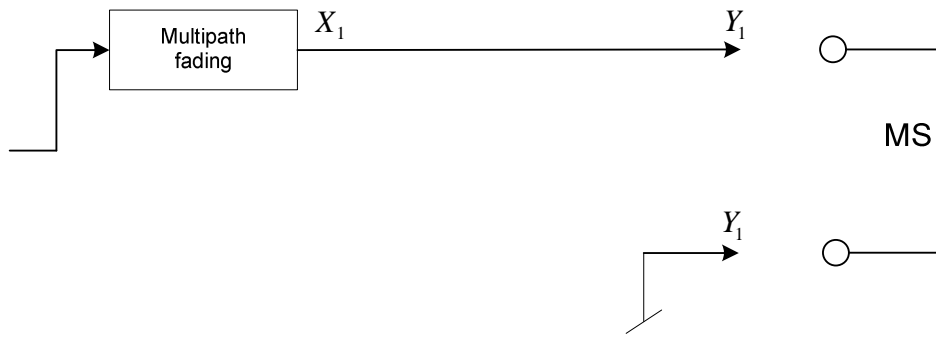

Figure N.3.2: Test setup when testing conformance to legacy requirements for MS capable of switching between single and dual antenna reception.

Annex O (normative): Minimum Performance Requirements for Assisted Galileo and Additional Navigation Satellite Systems (A-GANSS)

This Annex defines the minimum performance requirements for A-GANSS for MSs that support A-GANSS. It includes the minimum performance requirements for both MS based and MS assisted A-GANSS terminals. The minimum performance requirements also include combinations of A-GPS and A-GANSS.

O.1 General

O.1.1 Abbreviations

A-GANSS	Assisted - Galileo and Additional Navigation Satellite Systems
A-GNSS	Assisted - Global Navigation Satellite Systems
A-GPS	Assisted - Global Positioning System
AWGN	Additive White Gaussian Noise
C/A	Coarse/Acquisition
ECEF	Earth Centred, Earth Fixed
GPS	Global Positioning System
HDOP	Horizontal Dilution Of Precision
LOS	Line Of Sight
TOD	Time Of Day
TOW	Time Of Week
TTFF	Time To First Fix
WLS	Weighted Least Squares

O.1.2 Measurement parameters

O.1.2.1 MS based A-GANSS measurement parameters

In case of MS-based A-GANSS, the measurement parameters are contained in the RRLP GANSS LOCATION INFORMATION IE. The measurement parameter in case of MS-based A-GANSS is the horizontal position estimate reported by the MS and expressed in latitude/longitude.

O.1.2.2 MS assisted A-GANSS measurement parameters

In case of MS-assisted A-GANSS, the measurement parameters are contained in the RRLP GANSS MEASUREMENT INFORMATION IE. The measurement parameters in case of MS-assisted A-GANSS are the Code Phase Measurements. The MS GANSS Measurement parameters (reported in the GANSS MEASUREMENT INFORMATION IE) that may be combined with MS GPS Code Phase measurements are converted into a horizontal position estimate using the procedure detailed in clause O.7.

O.1.3 Response time

Max Response Time is defined as the time starting from the moment that the MS has received the final RRLP MEASURE POSITION REQUEST sent before the MS sends the MEASURE POSITION RESPONSE containing the Location Information or the GPS and GANSS Measurement Information, and ending when the MS starts sending the MEASURE POSITION RESPONSE containing the Location Information or the GPS and GANSS Measurement Information on the Air interface. The response times specified for all test cases are Time-to-First-Fix (TTFF) unless otherwise specified, i.e. the MS shall not re-use any information on GANSS time, location or other aiding data that was previously acquired or calculated and stored internally in the MS. A dedicated test message 'RESET MS POSITIONING STORED INFORMATION' has been defined in TS 44.014 for the purpose of deleting this information and is detailed in subclause O.3.1.10.

O.1.4 Time assistance

Time assistance is the provision of GANSS reference time to the MS from the network via RRLP messages. Currently two different GANSS time assistance methods can be provided by the network.

- a) Coarse time assistance is always provided by the network and provides current GANSS time to the MS. The time provided is within ± 2 seconds of GANSS system time. It is signalled to the MS by means of the GANSS Day and GANSS TOD fields in the GANSS Reference Time assistance data IE.
- b) Fine time assistance is optionally provided by the network and adds the provision to the MS of the relationship between the selected GANSS system time and the current GSM time. The accuracy of this relationship is $\pm 10 \mu\text{s}$ of the actual relationship. This addresses the case when the network can provide an improved GANSS time accuracy. It is signalled to the MS by means of the FNm, TN and BN fields in the GANSS Reference Time assistance data IE.

The specific GANSS system time is identified through the GANSS Time Id field of the GANSS Reference Time IE. In case where several GANSS are used in the tests, only one GANSS Time Id is used to determine the Time of Day. For all the constellations, the GANSS Time Model assistance and UTC Model assistance shall be available at the system simulator, as specified in subclause O.6.

The time of applicability of time assistance is the beginning of the Frame of the message containing the GANSS reference time.

O.1.4.1 Use of fine time assistance

The use of fine time assistance to improve the GANSS performance of the MS is optional for the MS, even when fine time assistance is signalled by the network. Thus, there are a set minimum performance requirements defined for all MSs and additional minimum performance requirements that are valid for fine time assistance capable MSs only. These requirements are specified in subclause O.2.1.2.

O.1.5 Error definitions

The 2D position error is defined by the horizontal difference in meters between the ellipsoid point reported or calculated from the MS MEASURE POSITION RESPONSE and the actual position of the MS in the test case considered.

O.1.6 Mobile stations supporting multiple constellations

Minimum performance requirements are defined for each global GANSS constellation (Galileo, Modernized GPS, and GLONASS). Mobile stations supporting multiple global constellations shall meet the minimum performance requirements for a combined scenario where each MS supported constellation is simulated.

NOTE: For test cases where signals from 'GPS' and 'Modernized GPS' are included, 'GPS' and 'Modernized GPS' are considered as a single constellation, unless otherwise specified.

O.1.7 Mobile stations supporting multiple signals

For mobile stations supporting multiple signals, different minimum performance requirements may be associated with different signals. The satellite simulator shall generate all signals supported by the MS. Signals not supported by the MS do not need to be simulated. The relative power levels of each signal type for each GNSS are defined in Table O.1-1. The individual test scenarios in clause O.2 define the reference signal power level for each satellite. The power level of each simulated satellite signal type shall be set to the reference signal power level defined in each test scenario in clause O.2 plus the relative power level defined in Table O.1-1.

Table O.1-1: Relative signal power levels for each signal type for each GNSS

	Galileo		GPS/Modernized GPS		GLONASS		QZSS		SBAS	
	Signal	Power	Signal	Power	Signal	Power	Signal	Power	Signal	Power
Signal power levels relative to reference power levels	E1	0 dB	L1 C/A	0 dB	G1	0 dB	L1 C/A	0 dB	L1	0 dB
	E6	+2 dB	L1C	+1.5 dB	G2	-6 dB	L1C	+1.5 dB		
	E5	+2 dB	L2C	-1.5 dB			L2C	-1.5 dB		
			L5	+3.6 dB			L5	+3.6 dB		

NOTE 1: For test cases which involve 'Modernized GPS', the satellite simulator shall also generate the GPS L1 C/A signal if the MS supports 'GPS' in addition to 'Modernized GPS'.

NOTE 2 : The signal power levels in the Test Parameter Tables represent the total signal power of the satellite per channel not e.g. pilot and data channels separately.

O.2 A-GANSS minimum performance requirements

The A-GANSS minimum performance requirements are defined by assuming that all relevant and valid assistance data is received by the MS in order to perform GPS and GANSS measurements and/or position calculation. This clause does not include nor consider delays occurring in the various signalling interfaces of the network.

In the following subclauses the minimum performance requirements are based on availability of the assistance data information and messages defined in clauses O.5 and O.6.

O.2.1 Sensitivity

A sensitivity requirement is essential for verifying the performance of A-GANSS receiver in weak satellite signal conditions. In order to test the most stringent signal levels for the satellites the sensitivity test case is performed in AWGN channel. This test case verifies the performance of the first position estimate, when the MS is provided with only coarse time assistance and when it is additionally supplied with fine time assistance.

O.2.1.1 Coarse time assistance

In this requirement 6 satellites are generated for the terminal. AWGN channel model is used.

Table O.2-1: Test parameters

System	Parameters	Unit	Value
	Number of generated satellites per system	-	See Table O.2-2
	Total number of generated satellites	-	6
	HDOP range		1.4 to 2.1
	Propagation conditions	-	AWGN
	GANSS coarse time assistance error range	seconds	±2
Galileo	Reference high signal power level	dBm	-142
	Reference low signal power level	dBm	-147
GPS ⁽¹⁾	Reference high signal power level	dBm	-142
	Reference low signal power level	dBm	-147
GLONASS	Reference high signal power level	dBm	-142
	Reference low signal power level	dBm	-147
NOTE 1: 'GPS' here means GPS L1 C/A, Modernized GPS, or both, dependent on MS capabilities.			

Table O.2-2: Power level and satellite allocation

		Satellite allocation for each constellation		
		GNSS-1 ⁽¹⁾	GNSS-2	GNSS-3
Single constellation	High signal level	1	-	-
	Low signal level	5	-	-
Dual constellation	High signal level	1	-	-
	Low signal level	2	3	-
Triple constellation	High signal level	1	-	-
	Low signal level	1	2	2
Note 1: For GPS capable receivers, GNSS-1, i.e. the system having the satellite with high signal level, shall be GPS.				

O.2.1.1.1 Minimum Requirements (Coarse time assistance)

The position estimates shall meet the accuracy and response time specified in table O.2-3.

Table O.2-3: Minimum requirements (coarse time assistance)

System	Success rate	2-D position error	Max response time
All	95 %	100 m	20 s

O.2.1.2 Fine time assistance

This requirement is only valid for fine time assistance capable MSs. In this requirement 6 satellites are generated for the terminal. AWGN channel model is used.

Table O.2-4: Test parameters

System	Parameters	Unit	Value
	Number of generated satellites per system	-	See Table O.2-5
	Total number of generated satellites	-	6
	HDOP range		1.4 to 2.1
	Propagation conditions	-	AWGN
	GNSS coarse time assistance error range	seconds	±2
	GNSS fine time assistance error range	µs	±10
Galileo	Reference signal power level	dBm	-147
GPS ⁽¹⁾	Reference signal power level	dBm	-147
GLONASS	Reference signal power level	dBm	-147
NOTE 1: 'GPS' here means GPS L1 C/A, Modernized GPS, or both, dependent on MS capabilities.			

Table O.2-5: Satellite allocation

	Satellite allocation for each constellation		
	GNSS-1	GNSS-2	GNSS-3
Single constellation	6	-	-
Dual constellation	3	3	-
Triple constellation	2	2	2

O.2.1.2.1 Minimum Requirements (Fine time assistance)

The position estimates shall meet the accuracy and response time specified in table O.2-6.

Table O.2-6: Minimum requirements for fine time assistance capable terminals

System	Success rate	2-D position error	Max response time
All	95 %	100 m	20 s

O.2.2 Nominal Accuracy

Nominal accuracy requirement verifies the accuracy of A-GANSS position estimate in ideal conditions. The primary aim of the test is to ensure good accuracy for a position estimate when satellite signal conditions allow it. This test case verifies the performance of the first position estimate.

In this requirement 6 satellites are generated for the terminal. If SBAS is to be tested one additional satellite shall be generated. AWGN channel model is used. The number of simulated satellites for each constellation is as defined in Table O.2-8.

Table O.2-7: Test parameters

System	Parameters	Unit	Value
	Number of generated satellites per system	-	See Table O.2-8
	Total number of generated satellites	-	6 or 7 ⁽²⁾
	HDOP Range	-	1.4 to 2.1
	Propagation conditions	-	AWGN
	GANSS coarse time assistance error range	seconds	±2
GPS ⁽¹⁾	Reference signal power level for all satellites	dBm	-128.5
Galileo	Reference signal power level for all satellites	dBm	-127
GLONASS	Reference signal power level for all satellites	dBm	-131
QZSS	Reference signal power level for all satellites	dBm	-128.5
SBAS	Reference signal power level for all satellites	dBm	-131
NOTE 1: 'GPS' here means GPS L1 C/A, Modernized GPS, or both, dependent on MS capabilities.			
NOTE 2: 7 satellites apply only for SBAS case.			

If QZSS is supported, one of the GPS satellites will be replaced by a QZSS satellite with respective signal support.

If SBAS is supported, the SBAS satellite with the highest elevation will be added to the scenario.

Table O.2-8: Satellite allocation

	Satellite allocation for each constellation			
	GNSS 1 ⁽¹⁾	GNSS 2 ⁽¹⁾	GNSS 3 ⁽¹⁾	SBAS
Single constellation	6	--	--	1
Dual constellation	3	3	--	1
Triple constellation	2	2	2	1
NOTE1: GNSS refers to global systems i.e., GPS, Galileo, GLONASS				

O.2.2.1 Minimum requirements (nominal accuracy)

The position estimates shall meet the 2-D accuracy and response time requirements in table O.2-9.

Table O.2-9: Minimum requirements

System	Success rate	2-D position error	Max response time
All	95 %	15 m	20 s

O.2.3 Dynamic Range

The aim of a dynamic range requirement is to ensure that a GNSS receiver performs well when visible satellites have rather different signal levels. Strong satellites are likely to degrade the acquisition of weaker satellites due to their cross-correlation products. Hence, it is important in this test case to use AWGN in order to avoid loosening the requirements due to additional margin because of fading channels. This test case verifies the performance of the first position estimate.

In this requirement 6 satellites are generated for the terminal. Two different reference power levels, denoted as 'high' and 'low' are used for each GNSS. The allocation of high and low power level satellites depends on the number of supported GNSSs and it is defined in Table O.2-11. AWGN channel model is used.

Table O.2-10: Test parameters

System	Parameters	Unit	Value
	Number of generated satellites per system	-	See Table O.2-11
	Total number of generated satellites	-	6
	HDOP Range	-	1.4 to 2.1
	Propagation conditions	-	AWGN
	GNSS coarse time assistance error range	seconds	±2
Galileo	Reference high signal power level	dBm	-127,5
	Reference low signal power level	dBm	-147
GPS ⁽¹⁾	Reference high signal power level	dBm	-129
	Reference low signal power level	dBm	-147
GLONASS	Reference high signal power level	dBm	-131.5
	Reference low signal power level	dBm	-147
NOTE 1: 'GPS' here means GPS L1 C/A, Modernized GPS, or both, dependent on MS capabilities.			

Table O.2-11: Power level and satellite allocation

		Satellite allocation for each constellation		
		GNSS 1 ⁽¹⁾	GNSS 2 ⁽¹⁾	GNSS 3 ⁽¹⁾
Single constellation	High signal level	2	--	--
	Low signal level	4	--	--
Dual constellation	High signal level	1	1	--
	Low signal level	2	2	--
Triple constellation	High signal level	1	1	1
	Low signal level	1	1	1
NOTE1: GNSS refers to global systems i.e., GPS, Galileo, GLONASS				

O.2.3.1 Minimum requirements (dynamic range)

The position estimates shall meet the accuracy and response time requirements in table O.2-12.

Table O.2-12: Minimum requirements

System	Success rate	2-D position error	Max response time
All	95 %	100 m	20 s

O.2.4 Multi-Path scenario

The purpose of the test is to verify the receiver's tolerance to multipath while keeping the test setup simple. This test verifies the performance of the first position estimate.

In this test 6 satellites are generated for the terminal. Some of the satellites have a one tap channel representing the Line-Of-Sight (LOS) signal. The other satellites have a two-tap channel, where the first tap represents the LOS signal and the second represents a reflected and attenuated signal as specified in subclause O.4.2. The number of satellites generated for each GNSS as well as the channel model used depends on the number of systems supported by the MS

and is defined in Table O.2-14. The channel model as specified in subclause O.4.2 further depends on the generated signal.

Table O.2-13: Test parameters

System	Parameters	Unit	Value
	Number of generated satellites per system	-	See Table O.2-14
	Total number of generated satellites	-	6
	HDOP range		1.4 to 2.1
	Propagation conditions	-	AWGN
	GANSS coarse time assistance error range	seconds	±2
Galileo	Reference signal power level	dBm	-127
GPS ⁽¹⁾	Reference signal power level	dBm	-128.5
GLONASS	Reference signal power level	dBm	-131
NOTE 1: 'GPS' here means GPS L1 C/A, Modernized GPS, or both, dependent on MS capabilities.			

Table O.2-14: Channel model allocation

		Channel model allocation for each constellation		
		GNSS-1	GNSS-2	GNSS-3
Single constellation	One-tap channel	2	--	--
	Two-tap channel	4	--	--
Dual constellation	One-tap channel	1	1	--
	Two-tap channel	2	2	--
Triple constellation	One-tap channel	1	1	1
	Two-tap channel	1	1	1

O.2.4.1 Minimum Requirements (multi-path scenario)

The position estimates shall meet the accuracy and response time requirements in table O.2-15.

Table O.2-15: Minimum requirements

System	Success rate	2-D position error	Max response time
All	95 %	100 m	20 s

O.2.5 Moving scenario and periodic location

This test case only applies to MSs supporting Supplementary Services for periodic reporting.

The purpose of the test case is to verify the receiver's capability to produce GANSS measurements or location fixes on a regular basis, and to follow when it is located in a vehicle that slows down, turns or accelerates. A good tracking performance is essential for a certain location services. A moving scenario with periodic location is well suited for verifying the tracking capabilities of an A-GANSS receiver in changing MS speed and direction. In the requirement the MS moves on a rectangular trajectory, which imitates urban streets. AWGN channel model is used. This test is not performed as a Time to First Fix (TTFF) test.

In this test 6 satellites are generated for the terminal. The MS is requested to use periodic location reporting with a reporting interval of 2 seconds.

The MS moves on a rectangular trajectory of 940 m by 1 440 m with rounded corner defined in figure O.2-1. The initial reference is first defined followed by acceleration to final speed of 100 km/h in 250 m. The MS then maintains the speed for 400 m. This is followed by deceleration to final speed of 25 km/h in 250 m. The MS then turn 90 degrees with turning radius of 20 m at 25 km/h. This is followed by acceleration to final speed of 100 km/h in 250 m. The sequence is repeated to complete the rectangle.

Table O.2-16: Trajectory Parameters

Parameter	Distance (m)	Speed (km/h)
$l_{11}, l_{15}, l_{21}, l_{25}$	20	25
$l_{12}, l_{14}, l_{22}, l_{24}$	250	25 to 100 and 100 to 25
l_{13}	400	100
l_{23}	900	100

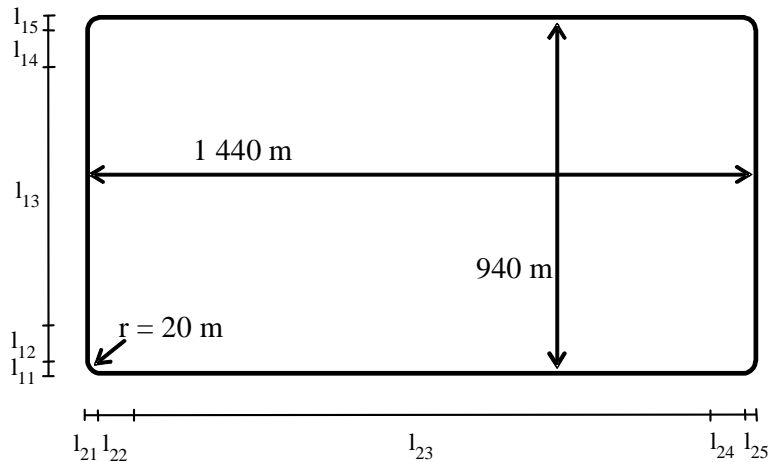

Figure O.2-1: Rectangular trajectory of the moving scenario and periodic location test case

Table O.2-17: Test Parameters

System	Parameters	Unit	Value
	Number of generated satellites per system	-	See Table O.2-18
	Total number of generated satellites	-	6
	HDOP Range per system	-	1.4 to 2.1
	Propagation conditions	-	AWGN
	GANSS coarse time assistance error range	seconds	± 2
Galileo	Reference signal power level for all satellites	dBm	-127
GPS ⁽¹⁾	Reference signal power level for all satellites	dBm	-128.5
GLONASS	Reference signal power level for all satellites	dBm	-131

NOTE 1: 'GPS' here means GPS L1 C/A, Modernized GPS, or both, dependent on MS capabilities.

Table O.2-18: Satellite allocation

	Satellite allocation for each constellation		
	GNSS 1 ⁽¹⁾	GNSS 2 ⁽¹⁾	GNSS 3 ⁽¹⁾
Single constellation	6	--	--
Dual constellation	3	3	--
Triple constellation	2	2	2

NOTE1: GNSS refers to global systems i.e., GPS, Galileo, GLONASS

O.2.5.1 Minimum Requirements (moving scenario and periodic location)

The position estimates shall meet the accuracy requirement of table O.2-19 with the periodic location reporting interval defined in table O.2-19 after the first reported position estimates.

NOTE: In the actual testing the MS may report error messages until it has been able to acquire GANSS measured results or a position estimate. The test equipment shall only consider the first measurement report different from an error message as the first position estimate in the requirement in table O.2-19.

Table O.2-19: Minimum requirements

System	Success rate	2-D position error	Periodical reporting interval
All	95 %	50 m	2 s

O.3 Test conditions

O.3.1 General

This clause specifies the additional parameters that are needed for the test cases specified in clause O.2 and applies to all tests unless otherwise stated.

O.3.1.1 Parameter values

Additionally, amongst all the listed parameters (see clause O.6), the following values for some important parameters are to be used in the MEASURE POSITION REQUEST message.

Table O.3-1: Parameter values

Information element	Value (except nominal accuracy test)	Value (nominal accuracy test)
Required Response Time	20s	20s
Accuracy	51.2 m	7.7 m

For the Moving scenario and periodic location test the following values for some important parameters are to be used in the REGISTER message.

Table O.3-2: Parameter values for Moving scenario and periodic location test

Information element	Value
Reporting Amount	To cover the required test time
Reporting Interval	2s

O.3.1.2 Time assistance

For every Test Instance in each test case, the GANSS Reference Time shall have a random offset, relative to GANSS System Time, within the error range of Coarse Time Assistance defined in the test case. This offset value shall have a uniform random distribution.

In addition, for every Fine Time Assistance Test Instance the IE BN shall have a random offset, relative to the true value of the relationship between the two time references, within the error range of Fine Time Assistance defined in the test case. This offset value shall have a uniform random distribution.

O.3.1.3 GANSS Reference Time

For every Test Instance in each test case, the GANSS Reference Time shall be advanced so that, at the time the fix is made, it is at least 2 minutes later than the previous fix.

O.3.1.4 Reference and MS locations

There is no limitation on the selection of the reference location, consistent with achieving the required HDOP for the Test Case. For each test instance the reference location shall change sufficiently such that the MS shall have to use the new assistance data. The uncertainty of the semi-major axis is 3 km. The uncertainty of the semi-minor axis is 3 km.

The orientation of major axis is 0 degrees. The uncertainty of the altitude information is 500 m. The confidence factor is 68 %.

For every Test Instance in each test case, the MS location shall be randomly selected to be within 3 km of the Reference Location. The Altitude of the MS shall be randomly selected between 0 m to 500 m above WGS-84 reference ellipsoid. These values shall have uniform random distributions.

For test cases which include satellites from regional systems, such as QZSS and SBAS, the reference location shall be selected within the defined coverage area of the systems.

O.3.1.5 Satellite constellation and assistance data

The satellite constellation shall consist of 24 satellites for GLONASS; 27 satellites for GPS, Modernized GPS and Galileo; 3 satellites for QZSS; and 2 satellites for SBAS. Almanac assistance data shall be available for all these satellites. At least 7 of the satellites per GPS, Modernized GPS, Galileo or GLONASS constellation shall be visible to the MS (that is, above 15 degrees elevation with respect to the MS). At least 1 of the satellites for QZSS shall be within 15 degrees of zenith; and at least 1 of the satellites for SBAS shall be visible to the MS. All other satellite specific assistance data shall be available for all visible satellites. In each test, signals are generated for only 6 satellites (or 7 if SBAS is included). The HDOP for the test shall be calculated using these satellites. The simulated satellites for GPS, Modernized GPS, Galileo and GLONASS shall be selected from the visible satellites for each constellation, consistent with achieving the required HDOP for the test.

O.3.1.6 Atmospheric delays

Typical Ionospheric and Tropospheric delays shall be simulated and the corresponding values inserted into the Ionospheric Model IEs.

O.3.1.7 Sensors

The minimum performances shall be met without the use of any data coming from sensors that can aid the positioning.

O.3.1.8 Information elements

The information elements that are available to the MS in all the test cases are listed in clause O.6.

O.3.1.9 GNSS signals

The GNSS signal is defined at the A-GNSS antenna connector of the MS. For MS with integral antenna only, a reference antenna with a gain of 0 dBi is assumed.

O.3.1.10 RESET MS POSITIONING STORED INFORMATION Message

In order to ensure each test instance in each test is performed under Time to First Fix (TTFF) conditions, a dedicated test signal (*RESET MS POSITIONING STORED INFORMATION*) defined in TS 44.014 shall be used.

When the MS receives the '*RESET MS POSITIONING STORED INFORMATION*' signal, with the IE *MS POSITIONING TECHNOLOGY* set to *AGNSS* it shall:

- discard any internally stored GPS and GANSS reference time, reference location, and any other aiding data obtained or derived during the previous test instance (e.g. expected ranges and Doppler);
- accept or request a new set of reference time or reference location or other required information, as in a TTFF condition;
- calculate the position or perform GNSS measurements using the 'new' reference time or reference location or other information.

O.3.2 GNSS System Time Offsets

If more than one GNSS is used in a test, the accuracy of the GNSS-GNSS Time Offsets used at the system simulator shall be better than 3 ns.

O.4 Propagation Conditions

O.4.1 Static propagation conditions

The propagation for the static performance measurement is an Additive White Gaussian Noise (AWGN) environment. No fading and multi-paths exist for this propagation model.

O.4.2 Multi-path case

Doppler frequency difference between direct and reflected signal paths is applied to the carrier and code frequencies. The Carrier and Code Doppler frequencies of LOS and multi-path for GNSS signals are defined in table O.4-1.

Table O.4-1: Multipath Case

Initial Relative Delay [m]	Carrier Doppler frequency of tap [Hz]	Code Doppler frequency of tap [Hz]	Relative mean Power [dB]
0	F_d	F_d / N	0
X	$F_d - 0.1$	$(F_d - 0.1) / N$	Y

NOTE: Discrete Doppler frequency is used for each tap.

Where the X and Y depends on the GNSS signal type and is shown in Table O.4-2, and N is the ratio between the transmitted carrier frequency of the signals and the transmitted chip rate as shown in Table O.4-3 (where k in Table O.4-3 is the GLONASS frequency channel number).

Table O.4-2

System	Signals	X [m]	Y [dB]
Galileo	E1	125	-4.5
	E5a	15	-6
	E5b	15	-6
GPS/Modernized GPS	L1 C/A	150	-6
	L1C	125	-4.5
	L2C	150	-6
GLONASS	L5	15	-6
	G1	275	-12.5
	G2	275	-12.5

Table O.4-3

System	Signals	N
Galileo	E1	1540
	E5a	115
	E5b	118
GPS/Modernized GPS	L1 C/A	1540
	L1C	1540
	L2C	1200
	L5	115
GLONASS	G1	$3135.03 + k \cdot 1.10$
	G2	$2438.36 + k \cdot 0.86$

The initial carrier phase difference between taps shall be randomly selected between 0 and 2π . The initial value shall have uniform random distribution.

O.5 Measurement sequence chart

O.5.1 General

The measurement sequence charts that are required in all the test cases are defined in this clause.

O.5.2 TTFF Measurement Sequence Chart

The measurement sequence chart for the TTFF test cases, for both MS-assisted and MS-based GANSS, is defined in this subclause.

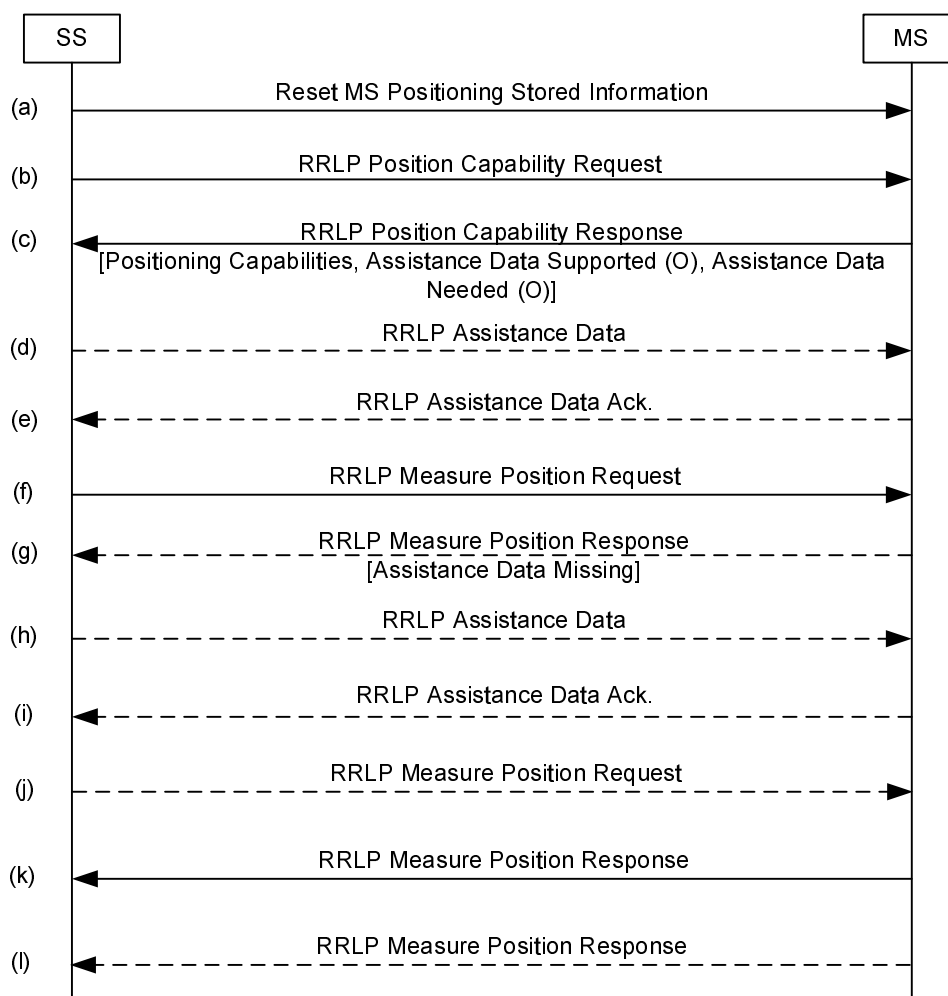

- (a) The system simulator sends a RESET MS POSITIONING STORED INFORMATION message with the IE *MS POSITIONING TECHNOLOGY* set to *AGNSS*.
- (b) The system simulator sends a RRLP POSITION CAPABILITY REQUEST message.
- (c) The MS responds with a RRLP POSITION CAPABILITY RESPONSE message, which includes the MS supported positioning methods, and may include a list of MS supported and MS needed assistance data.
- (d) If the MS at step (c) indicated needed assistance data, the system simulator provides the requested assistance data that are available as defined in subclause O.6 in one or more RRLP ASSISTANCE DATA messages.

- (e) Each RRLP ASSISTANCE DATA message is acknowledged by the MS.
- (f) The system simulator sends a RRLP MEASURE POSITION REQUEST message including the following information elements:

<i>METHOD TYPE</i>	set to either "MS assisted" or "MS based", dependent on the test case;
<i>POSITIONING METHODS</i>	set to "GPS";
<i>RESPONSE TIME</i>	set to 16 seconds;
<i>ACCURACY</i>	as defined in subclause O.3.1.1;
<i>MULTIPLE SETS</i>	set to "1";
<i>GANSS POSITIONING METHOD</i>	set according to the MS capabilities and test case;
<i>REQUIRED RESPONSE TIME</i>	as defined in subclause O.3.1.1.

- (g) The MS may respond with a RRLP MEASURE POSITION RESPONSE message including the *LOCATION INFORMATION ERROR IE* with "Error Reason" set to "GANSS assistance data missing", and including a request for additional GPS and/or GANSS assistance data.
- (h) If the MS requested additional assistance data at step (g), the system simulator provides the requested assistance data that are available as defined in subclause O.6 in one or more RRLP ASSISTANCE DATA messages.
- (i) Each RRLP ASSISTANCE DATA message is acknowledged by the MS.
- (j) If the MS requested additional assistance data at step (g), the system simulator sends a RRLP MEASURE POSITION REQUEST message with information elements included as specified in step (f).
- (k) The MS sends a RRLP MEASURE POSITION RESPONSE message including the *GANSS LOCATION INFORMATION IE* in case of MS-based GANSS, or including the *GPS MEASUREMENT INFORMATION* and/or *GANSS MEASUREMENT INFORMATION IE* in case of MS-assisted GANSS.
- (l) The MS may send one additional RRLP MEASURE POSITION RESPONSE message if the amount of measurement information it needs to send is too large to fit into one single message.

Steps (a) to (l) are repeated for each test instance.

O.6 Assistance data required for testing

This clause defines the assistance data IEs available in all test cases. The assistance data shall be given for satellites as defined in subclause O.3.1.5.

The information elements are given with reference to 3GPP TS 44.031, where the details are defined.

O.6.1 GPS assistance data

As defined in Annex M.6.

O.6.2 GANSS assistance data

- e) **GANSS Reference Time IE.** This information element is defined in subclause A.4.2.6.1 of 3GPP TS 44.031.

Table O.6-1: GANSS Reference Time IE

Name of the IE	Fields of the IE	All tests except Sensitivity Fine Time Assistance	Sensitivity Fine Time Assistance test
GANSS Reference Time			
	GANSS Day	Yes	Yes
	GANSS TOD	Yes	Yes
	GANSS TOD Uncertainty	Yes	Yes
	GANSS Time ID	Yes	Yes
	BCCH Carrier		Yes
	BSIC		Yes
	FNm		Yes
	TN		Yes
	BN		Yes
	FN ₁		Yes

- f) **GANSS Reference Location IE.** This information element is defined in subclause A.4.2.6.1 of 3GPP TS 44.031.

Table O.6-2: GANSS Reference Location IE

Name of the IE	Fields of the IE
GANSS Reference Location	Ellipsoid point with Altitude and uncertainty ellipsoid

- g) **GANSS Ionospheric Model IE.** This information element is defined in subclause A.4.2.6.1 of 3GPP TS 44.031.

Table O.6-3: GANSS Ionospheric Model IE

Name of the IE	Fields of the IE
GANSS Ionospheric Model	

- h) **GANSS Additional Ionospheric Model IE.** This information element is defined in subclause A.4.2.6.1 of 3GPP TS 44.031.

Table O.6-4: GANSS Additional Ionospheric Model IE

Name of the IE	Fields of the IE
GANSS Additional Ionospheric Model	

- i) **GANSS Time Model IE.** This information element is only required for multi system tests, and is defined in subclause A.4.2.6.2 of 3GPP TS 44.031.

Table O.6-5: GANSS Time Model IE

Name of the IE	Fields of the IE
GANSS Time Model	
	GNSS_TOD_ID For each GNSS included in the test.

- j) **GANSS Navigation Model IE.** This information element is defined in subclause A.4.2.6.2 of 3GPP TS 44.031.

Table O.6-6: GANSS Navigation Model IE

Name of the IE	Fields of the IE
GANSS Navigation Model	

Table O.6-6a: GANSS Clock and Orbit Model Choices

GANSS	Clock and Orbit Model Choice
Galileo	Model-1
Modernized GPS	Model-3
GLONASS	Model-4
QZSS QZS-L1	Model-2
QZSS QZS-L1C/L2C/L5	Model-3
SBAS	Model-5

- k) **GANSS Reference Measurement Information IE.** This information element is defined in subclause A.4.2.6.2 of 3GPP TS 44.031.

Table O.6-7: GANSS Reference Measurement Information IE

Name of the IE	Fields of the IE
GANSS Reference Measurement Information	
	SV_ID
	Doppler (0 th order term)
	Doppler (1 st order term)
	Doppler Uncertainty
	Code Phase
	Integer Code Phase
	Code Phase Search Window
	Azimuth
	Elevation

- l) **GANSS Almanac Model.** This information element is defined in subclause A.4.2.6.2 of 3GPP TS 44.031.

Table O.6-8: GANSS Almanac Model IE

Name of the IE	Fields of the IE
GANSS Almanac Model	

Table O.6-8a: GANSS Almanac Choices

GANSS	Almanac Model Choice
Galileo	Model-1
Modernized GPS	Model-3,4
GLONASS	Model-5
QZSS QZS-L1	Model-2
QZSS QZS-L1C/L2C/L5	Model-3,4
SBAS	Model-6

- m) **GANSS UTC Model IE.** This information element is defined in subclause A.4.2.6.2 of 3GPP TS 44.031.

Table O.6-9: GANSS UTC Model IE

Name of the IE	Fields of the IE
GANSS UTC Model	

- n) **GANSS Additional UTC Model IE.** This information element is defined in subclause A.4.2.6.2 of 3GPP TS 44.031.

Table O.6-10: GANSS Additional UTC Model IE

Name of the IE	Fields of the IE
GANSS Additional UTC Model	

Table O.6-10a: GANSS UTC Model Choices

GANSS	UTC Model Choice
Galileo	Model-1
Modernized GPS	Model-2
GLONASS	Model-3
QZSS QZS-L1	Model-1
QZSS QZS-L1C/L2C/L5	Model-2
SBAS	Model-4

- o) **GANSS Auxiliary Information IE.** This information element is defined in subclause A.4.2.6.2 of 3GPP TS 44.031.

Table O.6-11: GANSS Auxiliary Information IE

Name of the IE	Fields of the IE
GANSS Auxiliary Information	

O.7 Converting MS-assisted measurement reports into position estimates

O.7.1 Introduction

To convert the MS measurement reports in case of MS-assisted mode of A-GANSS into position errors, a transformation between the "measurement domain" (code-phases, etc.) into the "state" domain (position estimate) is necessary. Such a transformation procedure is outlined in the following clauses. The details can be found in [IS-GPS-200], [IS-GPS-705], [IS-GPS-800], [SBAS], [IS-QZSS], [GLONASS -ICD],[Galileo-ICD],[P. Axelrad, R.G. Brown] and [S.K. Gupta].

O.7.2 MS measurement reports

In case of MS-assisted A-GANSS, the measurement parameters are contained in the RRLP GANSS MEASUREMENT INFORMATION ELEMENT (subclause A.3.2.10 in 3GPP TS 44.031). In case the MS provides also measurements on the GPS L1 C/A signal, the measurement parameters are contained in the RRLP GPS MEASUREMENT INFORMATION ELEMENT (subclause A.3.2.5 in 3GPP TS 44.031). The measurement parameters required for calculating the MS position are:

- 1) Reference Time: The MS has two choices for the Reference Time:
 - a) "Reference Frame";
 - b) "GANSS TOD" and/or "GPS TOW" if GPS L1 C/A signal measurements are also provided.

Note: It is not expected that an MS will ever report both a GANSS TOD and a GPS TOW. However if two time stamps are provided and they derive from different user times, be aware that no compensation is made for this difference and this could affect the location accuracy.

- 2) Measurement Parameters for each GANSS and GANSS Signal: 1 to <maxSat>:
 - a) "SV ID"; mapping according to Table A.10.14 in 3GPP TS 44.031;
 - b) "Code Phase";
 - c) "Integer Code Phase";
 - d) "Code Phase RMS Error";
- 3) Additional Measurement Parameters in case of GPS L1 C/A signal measurements are also provided: 1 to <maxSat>:
 - a) "Satellite ID (SV PRN)";
 - b) "Whole GPS chips";
 - c) "Fractional GPS Chips";
 - d) "Pseudorange RMS Error".

Additional information required at the system simulator:

- 1) "Reference Location" (subclause A.4.2.4 or A.4.2.6.1 in 3GPP TS 44.031):
Used for initial approximate receiver coordinates.
- 2) "GANSS Navigation Model" (subclause A.4.2.6.2 in 3GPP TS 44.031):
Contains the ephemeris and clock correction parameters as specified in the relevant ICD of each supported GANSS; used for calculating the satellite positions and clock corrections.
- 3) "GANSS Ionospheric Model" (subclause A.4.2.6.1 in 3GPP TS 44.031):
Contains the ionospheric parameters which allow the single frequency user to utilize the ionospheric model as specified in [Galileo-ICD] for computation of the ionospheric delay.
- 4) "GANSS Additional Ionospheric Model" (subclause A.4.2.6.1 in 3GPP TS 44.031):
Contains the ionospheric parameters which allow the single frequency user to utilize the ionospheric model as specified in [QZSS-ICD] for computation of the ionospheric delay.
- 5) "GANSS Time Model" (subclause A.4.2.6.2 in 3GPP TS 44.031):
Contains the GNSS-GNSS Time Offset for each supported GANSS. Note, that "GANSS Time Model" IE contains only the sub-ms part of the offset. Any potential integer seconds offset may be obtained from "UTC Model" (subclause A.4.2.4 in 3GPP TS 44.031), "GANSS UTC Model" (subclause A.4.2.6.2 in 3GPP TS 44.031), or "GANSS Additional UTC Model" (subclause A.4.2.6.2 in 3GPP TS 44.031).
- 6) "Navigation Model" (subclause A.4.2.4 in 3GPP TS 44.031):
Contains the GPS ephemeris and clock correction parameters as specified in [IS-GPS-200]; used for calculating the GPS satellite positions and clock corrections in case of GPS L1 C/A signal measurements are the only GPS measurements provided in addition to GANSS measurements.
- 7) "Ionospheric Model" (subclause A.4.2.4 in 3GPP TS 44.031):
Contains the ionospheric parameters which allow the single frequency user to utilize the ionospheric model as specified in [IS-GPS 200] for computation of the ionospheric delay.

O.7.3 Weighted Least Squares (WLS) position solution

The WLS position solution problem is concerned with the task of solving for four unknowns; x_u, y_u, z_u the receiver coordinates in a suitable frame of reference (usually ECEF) and b_u the receiver clock bias relative to the selected GNSS specific system time. It typically requires the following steps:

Step 1: Formation of pseudo-ranges

The observation of code phase reported by the MS for each satellite SV_i is related to the pseudo-range/c modulo the "GNSS Code Phase Ambiguity", or modulo 1 ms (the length of the C/A code period) in case of GPS L1 C/A signal measurements. For the formation of pseudo-ranges, the integer number of milliseconds to be added to each code-phase measurement has to be determined first. Since 1 ms corresponds to a travelled distance of 300 km, the number of integer ms can be found with the help of reference location and satellite ephemeris. The distance between the reference location and each satellite SV_i at the time of measurement is calculated, and the integer number of milliseconds to be added to the MS code phase measurements is obtained.

Step 2: Correction of pseudo-ranges for the GNSS-GNSS time offsets

In case the MS reports measurements for more than a single GNSS, the pseudo-ranges are corrected for the time offsets between the GNSSs relative to the selected reference time using the GNSS-GNSS time offsets available at the system simulator:

$$\rho_{GNSS_m,i} \equiv \rho_{GNSS_m,i} - c \cdot (t_{GNSS_k} - t_{GNSS_m}),$$

where $\rho_{GNSS_m,i}$ is the measured pseudo-range of satellite i of $GNSS_m$. The system time t_{GNSS_k} of $GNSS_k$ is the reference time frame, and $(t_{GNSS_k} - t_{GNSS_m})$ is the available GNSS-GNSS time offset, and c is the speed of light.

Step 3: Formation of weighting matrix

The MS reported "Code Phase RMS Error" and/or "Pseudorange RMS Error" values are used to calculate the weighting matrix for the WLS algorithm described in [P. Axelrad, R.G. Brown]. According to 3GPP TS 44.031, the encoding for these fields is a 6 bit value that consists of a 3 bit mantissa, X_i and a 3 bit exponent, Y_i for each SV_i of $GNSS_j$:

$$w_{GNSS_j,i} = RMSError = 0.5 \times \left(1 + \frac{X_i}{8} \right) \times 2^{Y_i}$$

The weighting Matrix \mathbf{W} is defined as a diagonal matrix containing the estimated variances calculated from the "Code Phase RMS Error" and/or "Pseudorange RMS Error" values:

$$\mathbf{W} = \text{diag} \left\{ 1/w_{GNSS_1,1}^2, 1/w_{GNSS_1,2}^2, \dots, 1/w_{GNSS_1,n}^2, \dots, 1/w_{GNSS_m,1}^2, 1/w_{GNSS_m,2}^2, \dots, 1/w_{GNSS_m,l}^2 \right\}$$

Step 4: WLS position solution

The WLS position solution is described in e.g., [P. Axelrad, R.G. Brown] and usually requires the following steps:

- 1) Computation of satellite locations at time of transmission using the ephemeris parameters and user algorithms defined in the relevant ICD of the particular GNSS. The satellite locations are transformed into WGS-84 reference frame, if needed.
- 2) Computation of clock correction parameters using the parameters and algorithms as defined in the relevant ICD of the particular GNSS.
- 3) Computation of atmospheric delay corrections using the parameters and algorithms defined in the relevant ICD of the particular GNSS for the ionospheric delay, and using the Gupta model defined in [S.K. Gupta] p. 121 equation (2) for the tropospheric delay. For GNSSs which do not natively provide ionospheric correction models (e.g., GLONASS), the ionospheric delay is determined using the available ionospheric model (see subclause O.7.2) adapted to the particular GNSS frequency.
- 4) The WLS position solution starts with an initial estimate of the user state (position and clock offset). The Reference Location is used as initial position estimate. The following steps are required:

- a) Calculate geometric range (corrected for Earth rotation) between initial location estimate and each satellite included in the MS measurement report.
- b) Predict pseudo-ranges for each measurement including clock and atmospheric biases as calculated in 1) to 3) above and defined in the relevant ICD of the particular GNSS and [P. Axelrad, R.G. Brown].
- c) Calculate difference between predicted and measured pseudo-ranges $\Delta\rho$.
- d) Calculate the "Geometry Matrix" \mathbf{G} as defined in [P. Axelrad, R.G. Brown]:

$$\mathbf{G} \equiv \begin{bmatrix} -\hat{\mathbf{1}}_{GNSS_{1,1}}^T & 1 \\ -\hat{\mathbf{1}}_{GNSS_{1,2}}^T & 1 \\ \vdots & \vdots \\ -\hat{\mathbf{1}}_{GNSS_{1,n}}^T & 1 \\ \vdots & \vdots \\ -\hat{\mathbf{1}}_{GNSS_{m,1}}^T & 1 \\ -\hat{\mathbf{1}}_{GNSS_{m,2}}^T & 1 \\ \vdots & \vdots \\ -\hat{\mathbf{1}}_{GNSS_{m,l}}^T & 1 \end{bmatrix} \quad \text{with } \hat{\mathbf{1}}_{GNSS_{m,i}} \equiv \frac{\mathbf{r}_{s_{GNSS_{m,i}}} - \hat{\mathbf{r}}_u}{\left| \mathbf{r}_{s_{GNSS_{m,i}}} - \hat{\mathbf{r}}_u \right|} \quad \text{where } \mathbf{r}_{s_{GNSS_{m,i}}} \text{ is the satellite position vector for } SV_i$$

of $GNSS_m$ (calculated in 1) above), and $\hat{\mathbf{r}}_u$ is the estimate of the user location.

- e) Calculate the WLS solution according to [P. Axelrad, R.G. Brown]:

$$\Delta\hat{\mathbf{x}} = (\mathbf{G}^T \mathbf{W} \mathbf{G})^{-1} \mathbf{G}^T \mathbf{W} \Delta\rho$$

- f) Adding the $\Delta\hat{\mathbf{x}}$ to the initial state estimate gives an improved estimate of the state vector:

$$\hat{\mathbf{x}} \rightarrow \hat{\mathbf{x}} + \Delta\hat{\mathbf{x}}.$$

- 5) This new state vector $\hat{\mathbf{x}}$ can be used as new initial estimate and the procedure is repeated until the change in $\hat{\mathbf{x}}$ is sufficiently small.

Step 5: Transformation from Cartesian coordinate system to Geodetic coordinate system

The state vector $\hat{\mathbf{x}}$ calculated in Step 4 contains the MS position in ECEF Cartesian coordinates together with the MS receiver clock bias relative to the selected GNSS system time. Only the user position is of further interest. It is usually desirable to convert from ECEF coordinates x_u, y_u, z_u to geodetic latitude φ , longitude λ and altitude h on the WGS84 reference ellipsoid.

Step 6: Calculation of "2-D Position Errors"

The latitude φ / longitude λ obtained after Step 5 is used to calculate the 2-D position error.

Annex P (normative): Minimum receiver performance requirements for MSR BS

This annex defines the minimum receiver performance requirements that shall be fulfilled for GSM carrier in MSR BS when referenced from the 3GPP TS 37.104 [33].

P.1 Reference Sensitivity and interference performance

The minimum requirements for reference sensitivity and reference interference performance specified in the applicable parts of clauses 6.2, 6.3, 6.4, 6.5 and 6.6 apply.

P.2 Other receiver characteristics

P.2.1 Blocking characteristics

- a) Wanted signal GMSK, and wanted signal 8-PSK modulated
- b) Static propagation conditions
- c) Reference receiver performance for the following channels:
 - GMSK modulated speech channels according to requirements in table 1: TCH/FS,
 - If supported, 8-PSK modulated circuit-switched data channels according to table 1d: E-TCH/F (T) for highest supported coding scheme
 - If supported, 8-PSK modulated packet-switched channels (EGPRS) according to table 1b: lowest supported coding scheme (MCS) using BTTI and no PAN

For the Additional Narrowband blocking minimum requirement for GSM/EDGE, the following also applies:

- d) Narrow band blocking for interferer at frequency offsets ≥ 600 kHz to the end of the relevant receive band (apply only for Additional Narrowband blocking minimum requirements for GSM/EDGE)
- e) Blocking characteristics shall be fulfilled according to the criteria, definitions and requirements in subclause 5.1 for the channels and conditions above

P.2.2 Intermodulation characteristics

- a) Static propagation conditions
- b) Reference receiver performance for the following channels:
 - GMSK modulated speech channels according to requirements in table 1: TCH/FS ,
 - If supported, 8-PSK modulated circuit-switched data channels according to table 1d: E-TCH/F (T) for highest supported coding scheme
 - If supported, 8-PSK modulated packet-switched channels (EGPRS) according to table 1b: lowest supported coding scheme (MCS) using BTTI and no PAN

For the Additional narrowband intermodulation minimum requirement for GSM/EDGE, the following also applies:

- c) Intermodulation characteristics shall be fulfilled according to the criteria, definitions and requirements in subclause 5.2 for the channels and conditions above

P.2.3 AM suppression

AM suppression characteristics shall be fulfilled according to the criteria, definitions and requirements in subclause 5.3 for the following channels and conditions :

- a) Static propagation conditions
- b) Reference receiver performance for the following channels:
 - GMSK modulated speech channels according to requirements in table 1: TCH/FS ,
 - If supported, 8-PSK modulated circuit-switched data channels according to table 1d: E-TCH/F (T) for highest supported coding scheme
 - If supported, 8-PSK modulated packet-switched channels (EGPRS) according to table 1b: lowest supported coding scheme (MCS) using BTTI and no PAN

Annex Q(normative): Reference Test Scenarios for Voice services over Adaptive Multi-user channels on One Slot (VAMOS)

Q.1 Interferer configurations in downlink

Four different interference scenarios are defined for VAMOS downlink as follows:

Table Q.1-1 Reference Test Scenario for synchronous single co-channel interferer

Reference Test Scenario	Interfering Signal	Interferer relative power level	TSC	Interferer Delay range
VDTS-1	Co-channel 1	-	none	no delay

Table Q.1-2 Reference Test Scenarios for synchronous multiple interferers

Reference Test Scenario	Interfering Signal	Interferer power level relative to Co-channel 1	TSC	Interferer Delay range
VDTS-2	Co-channel 1	-	none	no delay
	Co-channel 2	-10 dB	none	no delay
	Adjacent 1	3 dB	none	no delay
	AWGN	-17 dB	-	-

Table Q.1-3 Reference Test Scenario for asynchronous single co-channel interferer

Reference Test Scenario	Interfering Signal	Interferer relative power level	TSC	Interferer Delay
VDTS-3	Co-channel 1	-	none	74 symbols
Note: In calculating I1, the power of the delayed interferer burst is averaged over the active part of the wanted signal burst.				

Table Q.1-4 Reference Test Scenario for synchronous single adjacent channel interferer

Reference Test Scenario	Interfering Signal	Interferer relative power level	TSC	Interferer Delay
VDTS-4	Adjacent 1	-	none	no delay

In all reference test scenarios in tables Q.1-1 to Q.1-4, the co channel and adjacent channel interferers are AQPSK modulated with SCPIR_DL = 0 dB. The power of the interferer is measured before any receiver filtering and during the active part of the desired burst (see 3GPP TS 45.004). No Training Sequence Code (TSC) is used for the interferers, and thus the midamble is filled with random data bits.

In some test scenarios an AWGN signal is added to the interferers. The AWGN signal power is measured over a bandwidth of 270,833 kHz.

Power ramping according to the requirements in Annex B shall be applied to all delayed interferers. The other interferers shall be random and continuous modulated signals.

NOTE: The non-delayed interferer is the same signal for which reference interference performance requirements normally apply (see clause 6.3).

In adjacent timeslots of the delayed interferers no power shall be applied. The delay is measured from the same bit position in the wanted signal burst and the interferer burst, where the position in the wanted signal is the reference position.

The C/I1 values in tables 2aa and 2ab are ratios of received powers expressed in dB; where C is the received power of the downlink signal using Normal burst for AQPSK (see 3GPP TS 45.002) and I1 is the received power of the dominant

external interferer (Co-channel 1 in tables Q.1-1 to Q.1-3) for VDTS-1 to VDTS-3 or the received power of the adjacent channel interferer for VDTS-4 (Adjacent 1 in table Q.1-4).

Q.2 Interferer configurations in uplink

Four different interference scenarios are defined for VAMOS uplink as follows:

Table Q.2-1 Reference Test Scenario 1

Reference Test Scenario	Interfering Signal	Interferer power level relative to Co-channel 1	TSC	Interferer Delay range
VUTS-1	Co-channel 1	-	none	no delay
	Co-channel 2	0 dB	none	no delay

Table Q.2-2 Reference Test Scenario 2

Reference Test Scenario	Interfering Signal	Interferer power level relative to Adjacent 1	TSC	Interferer Delay range
VUTS-2	Adjacent 1	-	none	no delay
	Adjacent 2	0 dB	none	no delay

Note: Both the Adjacent channel interferers are at the same adjacent channel frequency.

Table Q.2-3 Reference Test Scenario 3

Reference Test Scenario	Interfering Signal	Interferer power level relative to Co-channel 1	TSC	Interferer Delay
VUTS-3	Co-channel 1 ¹⁾	-	none	74 symbols
	Co-channel 2 ¹⁾	0 dB	none	74 symbols

¹⁾In calculating I1 (see table 2ac), the power of the delayed interferer shall be measured over the active part of the burst of VAMOS sub-channel 2.

Table Q.2-4 Reference Test Scenario 4

Reference Test Scenario	Interfering Signal	Interferer power level relative to Co-channel 1	TSC	Interferer Delay
VUTS-4	Co-channel 1	-	none	no delay
	Adjacent 1	3 dB	none	no delay

In all the reference scenarios in uplink, VUTS-1 to VUTS-4, the interferers are GMSK modulated. The power of the interferer is measured before any receiver filtering and during the active part of the desired burst (see 3GPP TS 45.004). No Training Sequence Code (TSC) is used for the interferers, and thus the midamble is filled with random data bits.

Power ramping according to the requirements in Annex B shall be applied to all delayed interferers.

NOTE: The non-delayed interferer is the same signal for which reference interference performance requirements normally apply (see clause 6.3).

In adjacent timeslots of the delayed interferers no power shall be applied. The delay is measured from the same bit position in the burst of VAMOS *subchannel 2* signal and the interferer burst, where the position in VAMOS *subchannel 2* signal is the reference position.

The C/I1 values in table 2ac are ratios of received powers expressed in dB, where C is the received power of VAMOS subchannel 2 using Normal burst for GMSK (see 3GPP TS 45.002) and I1 is the received power of Co-channel 1 (VUTS-1, VUTS-3 and VUTS-4) or Adjacent channel 1 (VUTS-2). VAMOS subchannel 1 shall be at an input level relative to VAMOS sub-channel 2 according to the Subchannel power imbalance ratio on uplink (SCPIR_UL) which is specified in table 2ac.

The wanted signals VAMOS subchannel 2 and VAMOS subchannel 1 and the interfering signals of the test scenarios in tables Q.2-1 to Q.2-4 are added to both RX antennas.

Q.3 Sensitivity test configuration in downlink

For reference sensitivity measurements, the measured level of the input signal (in dBm) of the received AQPSK signal for which the reference performance is to be satisfied are specified in tables 1s, 1t and 1u.

Q.4 Sensitivity test configuration in uplink

The received signal level in table 1v refers to the signal level of VAMOS subchannel 2. In addition to the GMSK signal from VAMOS subchannel 2 at signal level according to table 1v, the signal from VAMOS subchannel 1 is also added at both the RX antennas. The ratio of the received power of VAMOS subchannel 2 relative to the received power of VAMOS subchannel 1 shall be equal to the Subchannel power imbalance ratio on uplink (SCPIR_UL) as specified in table 1v.

Q.5 Time and frequency offset in uplink

For uplink in VAMOS mode, i.e. both interference and sensitivity limited cases *VAMOS subchannel 1* is offset in time and frequency with respect to *VAMOS subchannel 2*. In all these cases, the GMSK burst from *VAMOS subchannel 1* is:

- offset in time compared to *VAMOS subchannel 2* according to the probability distribution:

$$p(\text{Time offset}) = \begin{cases} 0.25, & \text{for Time offset} = -1 \text{ Normal Symbol Periods} \\ 0.5, & \text{for Time offset} = 0 \text{ Normal Symbol Periods} \\ 0.25, & \text{for Time offset} = 1 \text{ Normal Symbol Periods} \\ 0, & \text{else} \end{cases}$$

- offset in frequency compared to *VAMOS subchannel 2* according to the probability distribution:

$$p(\text{Frequency offset}) = \frac{1}{\sigma\sqrt{2\pi}} e^{-\frac{(\text{Frequency offset} - \mu)^2}{2\sigma^2}} \text{ where } \sigma \text{ and } \mu \text{ are given in the table Q.5-1}$$

Table Q.5-1 Frequency Offset Parameters for Paired Subchannel

Frequency Band	850/900	1800	1900
μ	45 Hz	90 Hz	95 Hz
σ	10 Hz	17 Hz	17 Hz

The time and frequency offset of *VAMOS subchannel 1* with respect to *VAMOS subchannel 2* shall be constant within a burst and may be selected in an implementation dependent way such that the above probabilities are satisfied.

Q.6 VAMOS DTX scenario in downlink

The purpose of this test case is to verify the VAMOS II mobile receiver performance when the paired *VAMOS subchannel* user goes into and comes out of DTX.

The modulation of the downlink VAMOS signal shall be switched between AQPSK (with -10 dB SCPIR) and GMSK according to the following:

$$p(\text{Downlink Modulation}) = \begin{cases} 0.4, & \text{for Downlink Modulation being GMSK} \\ 0.6, & \text{for Downlink Modulation being AQPSK} \end{cases}$$

The power of the GMSK burst in the downlink in this test case shall be 10.5 dB lower than the power of the AQPSK burst. The average input signal level over all the bursts at the reference performance for the VAMOS II MS shall be as per the table 1u. The reference performance according to section 6.2.1a shall be applicable for this test case.

Annex R (informative): Change history

SPEC	SMG#	CR	REV	PHASE	VERS	NEW_VERS	SUBJECT
05.05	s24	A063		R97	5.6.0	6.0.0	Reference performance for GPRS
05.05	s25	A067		R97	6.0.0	6.1.0	14.4kbps Data Service
05.05	s26	A065		R97	6.1.0	6.2.0	Repeater Systems using Frequency Shift
05.05	s26	A071		R97	6.1.0	6.2.0	Adjacent time slot rejection performance
05.05	s26	A073		R97	6.1.0	6.2.0	Frequency hopping performance under interference conditions
05.05	s26	A074		R97	6.1.0	6.2.0	Possibility for operators and manufacturers to define BTS output power
05.05	s26	A075		R97	6.1.0	6.2.0	Introducing performance requirement for the 11 bit PRACH
05.05	s26	A045		R98	6.4.0	7.0.0	Pico BTS
05.05	s27	A076		R97	6.2.0	6.3.0	False USF detection
05.05	s27	A077		R97	6.2.0	6.3.0	Power control levels 29-31 for DCS 1800
05.05	s27	A078		R97	6.2.0	6.3.0	DCS 1800 MS sensitivity for GPRS
05.05	s27	A080		R97	6.2.0	6.3.0	Correction of reference for MS test loop
05.05	s28	A083		R97	6.3.0	6.4.0	Signal level for reference interference measurements in GPRS
05.05	s28	A081		R98	6.4.0	7.0.0	BTS performance requirements for Picocells
05.05	s28	A082		R98	6.4.0	7.0.0	Harmonization between GSM and PCS 1 900 standard
05.05	s28	A084		R98	6.4.0	7.0.0	Introduction of CTS in GSM 05.05
05.05	s28	A091		R98	6.4.0	7.0.0	Transmitter / receiver performance in CTS
05.05	s29	A098		R98	7.0.0	7.1.0	Micro BTS: Deletion of Max output power per carrier values expressed in Watts
05.05	s29	A099		R98	7.0.0	7.1.0	Correction to pico-BTS interference performance
05.05	s29	A143		R98	7.0.0	7.1.0	AMR reference sensitivity and interference
05.05	s29	A100		R99	7.1.0	8.0.0	Output level dynamic operation for EDGE
05.05	s29	A102		R99	7.1.0	8.0.0	Blocking requirements for EDGE MS and BTS receivers
05.05	s29	A103		R99	7.1.0	8.0.0	Power classes for EDGE mobile stations
05.05	s29	A104		R99	7.1.0	8.0.0	Modulation Accuracy for EDGE MS and BTS
05.05	s29	A105		R99	7.1.0	8.0.0	Spectrum Mask for EDGE MS and BTS
05.05	s29	A106		R99	7.1.0	8.0.0	High input level requirements for EDGE receivers
05.05	s29	A107		R99	7.1.0	8.0.0	Introduction of LCS – Requirements on Location Measurement Unit
05.05	s29	A108		R99	7.1.0	8.0.0	Output power for EDGE BTS
05.05	s29	A111		R99	7.1.0	8.0.0	GSM 400 systems introduced in GSM 05.05
05.05	s30	A114		R99	8.0.0	8.1.0	Output level Dynamic operation in EDGE
05.05	s30	A115		R99	8.0.0	8.1.0	EDGE blocking requirement for micro and pico-BTS
05.05	s30	A116		R99	8.0.0	8.1.0	850 MHz frequency band and channel arrangement
05.05	s30	A117		R99	8.0.0	8.1.0	EDGE 850 MHz and 1900 MHz mixed mode
05.05	s30	A118		R99	8.0.0	8.1.0	Frequency compensation requirements for EDGE receivers
05.05	s30	A119		R99	8.0.0	8.1.0	Modulation accuracy for EDGE MS and BTS
05.05	s30	A120		R99	8.0.0	8.1.0	AMR reference sensitivity and interference
05.05	s30	A124		R99	8.0.0	8.1.0	Introduction of RATSCCH for AMR
05.05	s30	A126		R99	8.0.0	8.1.0	8-PSK requirements for GSM 400
05.05	s30	A127		R99	8.0.0	8.1.0	PCS 1900 MHz intermodulation requirements
05.05	s30	A129		R99	8.0.0	8.1.0	Allowed power level between two consecutive active time slots
05.05	s30	A159		R99	8.0.0	8.1.0	GSM in the 400 MHz bands: editorial modification
05.05	s30b	A132		R99	8.1.0	8.2.0	EDGE blocking requirement for micro and pico-BTS
05.05	s30b	A133		R99	8.1.0	8.2.0	Spurious emission in RX- and TX-band in other frequency bands
05.05	S31	A101		R99	8.2.0	8.3.0	Transmitter/receiver performance for EDGE
05.05	S31	A134		R99	8.2.0	8.3.0	Measurement Filter for EDGE EVM
05.05	S31	A135		R99	8.2.0	8.3.0	Alignment of Measurement Filter reference

SPEC	SMG#	CR	REV	PHASE	VERS	NEW_VERS	SUBJECT
05.05	S31	A136		R99	8.2.0	8.3.0	Clarification of Intra BTS Intermodulation Attenuation requirements for MXM 850 and MXM 1900 BTS
05.05	S31	A137		R99	8.2.0	8.3.0	Clarification of Intra BTS Intermodulation Attenuation requirements for PCS 1900 BTS
05.05	S31	A138		R99	8.2.0	8.3.0	Definition of MS for Mixed-mode network
05.05	S31	A139		R99	8.2.0	8.3.0	Correction to Output level dynamic operation
05.05	S31	A141		R99	8.2.0	8.3.0	Nominal Error Rate performance for EDGE
05.05	S31	A142		R99	8.2.0	8.3.0	Corrections to receiver Characteristics for EDGE
05.05	S31	A143		R99	8.2.0	8.3.0	Spurious emission measurement bandwidths updated to include GSM 400 systems
05.05	S31	A144		R99	8.2.0	8.3.0	Harmonization of Transmitter/receiver performance requirements for PCS 1900
05.05	S31	A147		R99	8.2.0	8.3.0	Relaxation of C/I performance requirement for CS4
05.05	S31	A149		R99	8.2.0	8.3.0	EVM requirements for EDGE BTS transmitter with combining equipment
05.05	S31	A150		R99	8.2.0	8.3.0	Introduction of Incremental Redundancy Receiver Performance for MS
05.05	S31	A151		R99	8.2.0	8.3.0	Switching Transients for 8-PSK Modulation
05.05	S31	A237		R99	8.2.0	8.3.0	RF Requirements for TOA LMU
05.05	S31	A239		R99	8.2.0	8.3.0	Requirements on E-OTD LMU and E-OTD MS
05.05	S31b	A247		R99	8.3.0	8.4.0	Conforming requirements for LMUs containing a control mobile station
05.05	S31b	A154		R99	8.3.0	8.4.0	Completion of 3GPP TS 45.005 for EDGE and clean-up

SPEC	SMG#	CR	REV	PHASE	VERS	NEW_VERS	SUBJECT
05.05	S32	A157		R99	8.4.0	8.5.0	Removal of duplicated figures
05.05	S32	A160		R99	8.4.0	8.5.0	Alignment of spurious emissions GSM-3G (UTRA): BTS
05.05	S32	A161		R99	8.4.0	8.5.0	Alignment of spurious emissions GSM-3G (UTRA): MS September 2000 - TSG-GERAN#1
05.05	G01	A162		R99	8.5.0	8.6.0	Pico BTS Reference interference level clarification
05.05	G01	A163		R99	8.5.0	8.6.0	Alignment of spurious emissions GSM-3G(UTRA): BTS
05.05	G01	A164		R99	8.5.0	8.6.0	Alignment of spurious emissions GSM-3G(UTRA): MS
05.05	G01	A168	1	R99	8.5.0	8.6.0	Definition of "small MS"
05.05	G01	A172		R99	8.5.0	8.6.0	CR 05.05-A172 Correction on CS-4 performance requirements
05.05	G01	A173	1	R99	8.5.0	8.6.0	Clarification of BTS output power capability with 8-PSK September 2000 - TSG-GERAN#1 Release 4
05.05	G01	A165	1	Release 4	8.6.0	4.0.0	Introduction of GSM 700 in 05.05 GSM on 700 MHz Frequency Band Oct 2000: Correction to references. November 2000 - TSG-GERAN#2 Release 4
					4.0.0	4.0.1	
45.005	G02	001	2	Release 4	4.0.1	4.1.0	NER requirements for EGPRS
45.005	G02	002	1	Release 4	4.0.1	4.1.0	Tolerance of BTS output power levels
45.005	G02	003		Release 4	4.0.1	4.1.0	Alignment of AM suppression requirements for PCS 1900 MS
45.005	G02	004	1	Release 4	4.0.1	4.1.0	Testing of Blocking requirements for MXM 1900 BSS
45.005	G02	005		Release 4	4.0.1	4.1.0	Testing of Intra BSS intermodulation attenuation requirements for MXM 1900 BSS
					4.1.0	4.1.1	Front page layout correction January 2001 - TSG-GERAN#3 Release 4
45.005	G03	010		Release 4	4.1.1	4.2.0	Correction of Power vs Time mask for 8-PSK
45.005	G03	011	1	Release 4	4.1.1	4.2.0	Definition of MXM systems missing
45.005	G03	012		Release 4	4.1.1	4.2.0	Testing of Intra BSS intermodulation attenuation requirements for MXM 850 BSS
45.005	G03	013		Release 4	4.1.1	4.2.0	Alignment of AM suppression requirements for MXM 1900 BTS with PCS 1900 BTS and MXM 850 BTS with GSM 850 BTS
45.005	G03	014		Release 4	4.1.1	4.2.0	Mixed-Mode Systems Intermodulation Attenuation
45.005	G03	015	1	Release 4	4.1.1	4.2.0	Interpretation of common DCS 1800 / PCS 1900 ARFCN numbers when transmitted on other bands April 2001 - TSG-GERAN#4 Release 4
45.005	G04	016	1	Release 4	4.2.0	4.3.0	Clarification of Origin Offset Suppression requirements
45.005	G04	017	3	Release 4	4.2.0	4.3.0	Dynamic ARFCN mapping
45.005	G04	018	1	Release 4	4.2.0	4.3.0	Corrections to facilitate the interpretation
45.005	G04	019		Release 4	4.2.0	4.3.0	Removal of requirements valid before December 1999
45.005	G04	020		Release 4	4.2.0	4.3.0	Removal of requirements for Intermodulation between MS June 2001 - TSG-GERAN#4 Release 4
45.005	G05	021		Release 4	4.3.0	4.4.0	Corrections for clarification regarding output power and blocking requirements June 2001 - TSG-GERAN#4 Release 5

Change history							
Date	TSG #	TSG Doc.	CR	Rev	Subject/Comment	Old	New
2001-06	05	GP-011259	022		Introduction of requirements for Wideband AMR FR GMSK modulated speech channels	4.4.0	5.0.0
2001-08	06	GP-011910	024	1	Correction to 45.005 – Incorrect references in section H.2.2.2	5.0.0	5.1.0
2001-08	06	GP-011537	026		Corrections for clarification regarding GSM 700 MS, GSM 850 MS and PCS 1900 MS requirements on spurious emissions	5.0.0	5.1.0
2001-08	06	GP-011944	031		Alignment to 44.018 for the definition of the BAND_INDICATOR field	5.0.0	5.1.0
2001-11	07	GP-012747	007	3	Introduction of requirements for adaptive half rate speech channels with 8-PSK modulation	5.1.0	5.2.0
2001-11	07	GP-012773	036	1	Correction of references to relevant 3GPP TSs	5.1.0	5.2.0
2001-11	07	GP-012777	037		Correction to wideband AMR receiver performance tables	5.1.0	5.2.0
2002-04	09	GP-021155	041	1	Correction of AMR FR inband performance requirement	5.2.0	5.3.0
2002-04	09	GP-021170	042	1	Alignment of number of codecs for WB-AMR to proposed set	5.2.0	5.3.0
2002-06	10	GP-021401	043		Introduction of AMR-WB 8PSK	5.3.0	5.4.0
2002-06	10	GP-021958	044	1	Introduction of TCH/WFS receiver performance requirements	5.3.0	5.4.0
2002-06	10	GP-021403	045		Introduction of O-TCH/AHS receiver performance requirements	5.3.0	5.4.0
2002-06	10	GP-021404	046		Introduction of O-TCH/WFS receiver performance requirements	5.3.0	5.4.0
2002-06	10	GP-021405	047		Introduction of O-TCH/WHS receiver performance requirements	5.3.0	5.4.0
2002-06	10	GP-022023	048	1	Introduction of O-FACCH receiver performance requirements	5.3.0	5.4.0
2002-06	10	GP-021412	049		Editorial clean up of references	5.3.0	5.4.0
2002-06	10	GP-022031	054		AMR AHS7.4 static channel performance correction	5.3.0	5.4.0
2002-08	11	GP-022468	056		Correction to TCH/WFS receiver performance requirements	5.4.0	5.5.0
2002-08	11	GP-022530	057		Correction to O-TCH/WHS receiver performance requirements	5.4.0	5.5.0
2002-11	12	GP-023075	061		Correction of performance requirements for O-TCH/WFS	5.5.0	5.6.0
2002-11	12	GP-023076	062		Correction of performance requirements for O-TCH/WHS	5.5.0	5.6.0
2002-11	12	GP-023077	063		Correction of performance requirements for O-TCH/AHS	5.5.0	5.6.0
2002-11	12	GP-023078	064		Correction of performance requirements for TCH/WFS	5.5.0	5.6.0
2002-11	12	GP-023079	065		Correction of performance requirements for O-FACCH channels	5.5.0	5.6.0
2002-11	12	GP-023080	066		Correction to reference performance for AMR Rel5 Release 6	5.5.0	5.6.0
2002-11	12	GP-023319	052	2	Implementation of new frequency ranges	5.6.0	6.0.0
2002-11	12	GP-023422	060	1	Correction of antenna Feeder loss compensator requirements	5.6.0	6.0.0
2003-02	13	GP-030150	059	2	Rice doppler spectrum definition	6.0.0	6.1.0
2003-02	13	GP-030283	069		Correction to abbr. in reference interference performance requirements	6.0.0	6.1.0
2003-04	14	GP-030720	071		Correction of static AMR sensitivity requirements for TCH/AHS	6.1.0	6.2.0
2003-04	14	GP-030867	074		Correction of transmitted power level versus time	6.1.0	6.2.0
2003-08	16	GP-032232	078	1	Introduction of mobile station multislot power classes	6.2.0	6.3.0
2004-02	18	GP-040487	080	1	Flexible Layer One	6.3.0	6.4.0
2004-04	19	GP-040875	084		Correction to transmitted power level vs. time mask	6.4.0	6.5.0
2004-04	19	GP-041055	085		Input signal level for interference performance for FLO	6.4.0	6.5.0
2004-06	20	GP-041698	087		Inband signalling bits for reference TFCs	6.5.0	6.6.0
2004-11	22	GP-042829	092	2	Introduction of DARP performance requirements	6.6.0	6.7.0
2004-11	22	GP-042753	093	1	Maximum output power when the MS transmits on	6.6.0	6.7.0

					more slots than assigned for the uplink		
2004-11	22	GP-042592	094		FLO performance requirements	6.6.0	6.7.0
2004-11	22	GP-042857	097		Removal of PTM-M	6.6.0	6.7.0
2005-01	23	GP-050041	098		Table 1i non-existent	6.7.0	6.8.0
2005-01	23	GP-050145	100		Removal of a restriction to support full power on two slots on 1800/1900 frequency bands, for certain multiband terminal designs	6.7.0	6.8.0
2005-01	23	GP-050192	101		DARP - removal of brackets plus one clarification	6.7.0	6.8.0
2005-04	24	GP-050906	102	3	Performance requirements for Repeated FACCH	6.8.0	6.9.0
2005-04	24	GP-051060	105	1	GSM 750 corrections	6.8.0	6.9.0
2005-04	24	GP-051053	107	1	Performance requirements for E-TCH/F32.0	6.8.0	6.9.0
2005-04	24	GP-050974	108		Clarification on the wanted signal level for adjacent channel performance	6.8.0	6.9.0
2005-04	24	GP-051061	106	1	Introduction of GSM 710	6.9.0	7.0.0
2005-06	25	GP-051283	114		Addition of new frequency band (e.g. T-GSM810) to the repeater annex E	7.0.0	7.1.0
2005-06	25	GP-051766	115	2	Introduction of T-GSM 810 frequency band	7.0.0	7.1.0
2005-06	25	GP-051472	116		Reduced interslot MS output power dynamic range on a multislot configuration	7.0.0	7.1.0
2005-06	25	GP-051717	122	1	Performance requirements for Repeated Downlink FACCH	7.0.0	7.1.0
2005-09	26	GP-051981	0123		Correction and alignment for PCS 1900 MS power mask	7.1.0	7.2.0
2005-09	26	GP-052024	0127		Removal of RATSCCH Identification Requirement	7.1.0	7.2.0
2005-09	26	GP-052050	0129		Corrections and clarifications for Repeated Downlink FACCH	7.1.0	7.2.0
2005-11	27	GP-052671	0120	2	Performance requirements for E-TCH/F32.0	7.2.0	7.3.0
2005-11	27	GP-052673	0131	1	Performance requirements for FLO	7.2.0	7.3.0
2005-11	27	GP-052606	0133		Repeated SACCH performance requirements	7.2.0	7.3.0
2006-01	28	GP-060325	0135	1	Repeated SACCH performance requirements	7.3.0	7.4.0
2006-01	28	GP-060327	0137	1	Repeated Downlink FACCH/H	7.3.0	7.4.0
2006-04	29	GP-060713	0139		Repeated SACCH performance - removal of brackets	7.4.0	7.5.0
2006-04	29	GP-060923	0140	1	Editorial correction of frequency range	7.4.0	7.5.0
2006-06	30	GP-061111	0141		Correction of terminology: "allocation" vs. "assignment"	7.5.0	7.6.0
2006-06	30	GP-061475	0142	2	A-GPS Minimum Performance specification baseline	7.5.0	7.6.0
2006-09	31	GP-061653	0144		Correction of undefined or wrong references	7.6.0	7.7.0
2006-11	32	GP-062452	0147	1	Introduction of performance requirements for DARP phase II (MSRD)	7.7.0	7.8.0
2007-02	33	GP-070110	0149		Max Response Time defined for A-GPS Minimum Performance requirements	7.8.0	7.9.0
2007-02	33	GP-070111	0150		Clarifications to A-GPS Minimum Performance requirements	7.8.0	7.9.0
2007-02	33	GP-070159	0151		Performance requirements for DARP phase II (MSRD) – Removal of brackets	7.8.0	7.9.0
2007-02	33	GP-070367	0152	1	Guard period handling option in an exceptional GPRS case	7.8.0	7.9.0
2007-05	34	GP-071008	0155	1	MSRD (DARP Phase II) requirements in Downlink Dual Carrier Configurations	7.9.0	7.10.0
2007-08	35	GP-071204	0154	2	Correction to extreme condition voltages for Lithium batteries in table D.2.2	7.10.0	7.11.0
2007-08	35	GP-071205	0156		Correction for multislot power versus time mask	7.10.0	7.11.0
2007-08	35	GP-071545	0157	2	Introduction of requirements for REDHOT, HUGE and LATRED	7.10.0	7.11.0
2007-11	36	GP-071957	0158	1	Time masks for EGPRS2	7.11.0	7.12.0
2007-11	36	GP-071959	0159	1	Clarifications and minor corrections for EGPRS2	7.11.0	7.12.0
2007-11	36	GP-071892	0160	2	MS Antenna Performance Requirements	7.11.0	7.12.0
2007-11	36	GP-071969	0162		Performance requirements for DARP phase I & II – Support of GSM 400 and 700 bands	7.11.0	7.12.0
2008-02	37	GP-080363	0163	1	Correction of requirement tables for EGPRS2 and RTTI	7.12.0	7.13.0
2008-02	37	GP-080120	0166		Correction of IBSS requirements for GSM 700, GSM 850 and PCS 1900	7.12.0	7.13.0
2008-02	37	GP-080292	0167		EVM measurement filter for higher symbol rate	7.12.0	7.13.0
2008-02	37	GP-080394	0161	4	Introduction of a new multicarrier BTS class	7.13.0	8.0.0
2008-05	38	GP-080500	0170		Miscellaneous corrections	8.0.0	8.1.0
2008-05	38	GP-080503	0172		Output power definition	8.0.0	8.1.0

2008-05	38	GP-080779	0174	1	Spectrum due to modulation of the wide bandwidth pulse shape	8.0.0	8.1.0
2008-05	38	GP-080621	0178		Removal of correction tables for performance requirement for LATRED	8.0.0	8.1.0
2008-05	38	GP-080625	0180		Power vs Time Masks for EGPRS2-B	8.0.0	8.1.0
2008-05	38	GP-080929	0183	2	Corrections and clarifications to multicarrier BTS class	8.0.0	8.1.0
2008-08	39	GP-081318	0176	2	EVM for EGPRS2 DL	8.1.0	8.2.0
2008-08	39	GP-081320	0182	3	Proposal for some receiver performance values	8.1.0	8.2.0
2008-08	39	GP-081268	0190	1	Correction of reference interference performance for DARP phase II MS on a Downlink Dual Carrier configuration	8.1.0	8.2.0
2008-08	39	GP-081380	0191	1	Addition of requirements new frequency bands for co-existence and co-siting	8.1.0	8.2.0
2008-08	39	GP-081416	0193	2	Aligning GSM 700 frequencies usage with other 3GPP technologies	8.1.0	8.2.0
2008-08	39	GP-081426	0194	3	Clarifications of requirements for multicarrier BTS class 1 and 2	8.1.0	8.2.0
2008-11	40	GP-081588	0188	2	Mixed modulation USF	8.2.0	8.3.0
2008-11	40	GP-081796	0196	1	EVM for EGPRS2 DL	8.2.0	8.3.0
2008-11	40	GP-081591	0198		Clarification for Interference ratio for adjacent channel requirements	8.2.0	8.3.0
2008-11	40	GP-081595	0200		Reference performance for EGPRS2	8.2.0	8.3.0
2008-11	40	GP-081903	0202	2	Reference Performance for LATRED	8.2.0	8.3.0
2008-11	40	GP-081883	0203	2	Corrections to MCBTS requirements	8.2.0	8.3.0
2008-11	40	GP-081881	0204	2	Wideband noise lower limit in MC-BTS	8.2.0	8.3.0
2008-11	40	GP-081886	0207		Correction of MS requirements for spurious emission in 700 MHz band	8.2.0	8.3.0
2009-02	41	GP-090306	0210	1	Enhancement of readability of multicarrier spectral requirements	8.3.0	8.4.0
2009-02	41	GP-090438	0211	1	Introduction of multicarrier BTS class for GSM 700, GSM 850 and PCS 1900	8.3.0	8.4.0
2009-02	41	GP-090418	0212	1	Correction of requirements for Nominal Error Rate at higher order modulations	8.3.0	8.4.0
2009-02	41	GP-090208	0214		Correction of frequency range for GSM 700 regarding blocking requirements	8.3.0	8.4.0
2009-02	41	GP-090441	0215	1	Correction of absolute limit for IM products from multicarrier BTS	8.3.0	8.4.0
2009-02	41	GP-090417	0217	1	Reference Performance for EGPRS2, Sensitivity	8.3.0	8.4.0
2009-02	41	GP-090220	0219		Reference Performance for EGPRS2, Co-Channel interference	8.3.0	8.4.0
2009-02	41	GP-090430	0221	1	Reference Performance for EGPRS2, Adjacent-Channel interference	8.3.0	8.4.0
2009-02	41	GP-090230	0223		EVM for EGPRS2-B DL	8.3.0	8.4.0
2009-02	41	GP-090433	0224	1	Clarification of exceptions for MCBTS regarding Spectrum due to modulation and wideband noise	8.3.0	8.4.0
2009-02	41	GP-090537	0226	3	Alignment of Power Level in Nominal Error Rate Measurement with GMSK Modulation to the Relaxed Blocking Values of GSM 400, T-GSM 810 and E-GSM 900	8.3.0	8.4.0
2009-05	42	GP-090968	0229	1	Introduction of EVM requirement for EGPRS2 for Repeater	8.4.0	8.5.0
2009-05	42	GP-090667	0232		Addition of EGPRS2 DL Performance Requirements for MSRD Capable Mobiles	8.4.0	8.5.0
2009-05	42	GP-090693	0235		EVM for EGPRS2-A, UL	8.4.0	8.5.0
2009-05	42	GP-090977	0239	2	Introduction of MCS-0	8.4.0	8.5.0
2009-05	42	GP-091041	0242	3	Reference performance EGPRS2-A, DL, Adjacent channel interference	8.4.0	8.5.0
2009-05	42	GP-090827	0246	1	Reference performance EGPRS2-A, UL, Co-channel and Adjacent channel interference	8.4.0	8.5.0
2009-05	42	GP-091045	0249	2	Clarifications of requirements for Spectrum due to modulation for MCBTS at frequency offset below 1.8 MHz	8.4.0	8.5.0
2009-05	42	GP-090722	0251		Clarifications of requirements for Spectrum due to switching transients for MCBTS	8.4.0	8.5.0
2009-05	42	GP-090995	0252	1	Alignment of requirements for Nominal Error Rate (NER) and RACH performance with blocking	8.4.0	8.5.0

					requirements for MCBTS in lower frequency bands		
2009-05	42	GP-090997	0253	1	Correction of absolute limit for IM products and related clarifications for multicarrier BTS	8.4.0	8.5.0
2009-05	42	GP-090897	0255	1	Reference performance EGPRS2-B, DL, Sensitivity and Co-channel performance	8.4.0	8.5.0
2009-05	42	GP-090881	0257		Reference performance EGPRS2, UL, Sensitivity	8.4.0	8.5.0
2009-05	42	GP-090985	0259		Improvement of alignment between spurious emissions of MCBTS Classes 1 and 2	8.4.0	8.5.0
2009-09	43	GP-091253	0237	3	Spectrum due to modulation and wide band noise, narrow pulse EGPRS2-B	8.5.0	8.6.0
2009-09	43	GP-091257	0244	1	Reference performance EGPRS2-A, 400 kHz Adjacent channel interference	8.5.0	8.6.0
2009-09	43	GP-091132	0262		Introduction of EVM requirement for EGPRS2 for Repeater	8.5.0	8.6.0
2009-09	43	GP-091269	0269		Relaxation of reference performance EGPRS2-A, DL, Co-channel and Adj-channel	8.5.0	8.6.0
2009-09	43	GP-091275	0273		Reference performance EGPRS2-B, Sensitivity and Reduced Latency	8.5.0	8.6.0
2009-09	43	GP-091281	0277		Reference performance EGPRS2-B, UL, Co-channel	8.5.0	8.6.0
2009-09	43	GP-091674	0281	2	Reference performance EGPRS2-B, UL, Adj-channel	8.5.0	8.6.0
2009-09	43	GP-091296	0286		Removal of brackets, RMS EVM, EGPRS2, Base station	8.5.0	8.6.0
2009-09	43	GP-091302	0288		Removal of brackets: NER, Adj-ch signal levels and Pico-BTS requirements for EGPRS2	8.5.0	8.6.0
2009-09	43	GP-091567	0289	1	Correction of lower frequency offset limit for exceptions in requirements for Spectrum due to modulation and wide band noise for MCBTS	8.5.0	8.6.0
2009-09	43	GP-091322	0294		Removal T-GSM 900	8.5.0	8.6.0
2009-09	43	GP-091323	0295		Introduction of requirements for protection of services in the new frequency bands 1880-1920 MHz and 2300-2400 MHz available for 3GPP access technologies	8.5.0	8.6.0
2009-09	43	GP-091740	0297	2	Reference performance EGPRS2-B, DL, Sensitivity (updates and additions)	8.5.0	8.6.0
2009-09	43	GP-091331	0299		Reference performance EGPRS2-B, DL, Co-channel (updates and additions)	8.5.0	8.6.0
2009-09	43	GP-091736	0301	2	Introduction of MCBTS capability for operating split frequency allocation	8.5.0	8.6.0
2009-09	43	GP-091664	0305		Removal of blocking, IM characteristics and AM suppression receiver requirements for QPSK, 16QAM and 32QAM modulations introduced in EGPRS2	8.5.0	8.6.0
2009-09	43	GP-091585	0290	1	Introduction of Minimum receiver performance for multicarrier BTS declared as Multi-standard capable base station (MSR BS)	8.6.0	9.0.0
2009-09	43	GP-091771	0303	3	Restructuring TS 45.005 to facilitate referencing to relevant Single RAT requirements from MSR BS TS	8.6.0	9.0.0
2009-09	43	GP-091682	0306		Additional GANSS Minimum Performance requirements	8.6.0	9.0.0
2009-11	44	GP-092127	284	2	Single Antenna Requirements for EGPRS2-B, UL	9.0.0	9.1.0
2009-11	44	GP-091965	0307	3	Removal of Brackets, EGPRS2-A UL	9.0.0	9.1.0
2009-11	44	GP-092190	0310	4	Removal of Brackets, EGPRS2-B UL	9.0.0	9.1.0
2009-11	44	GP-091991	0314	2	Reference performance EGPRS2-B, UL, 400 kHz Adjacent channel interference, without brackets	9.0.0	9.1.0
2009-11	44	GP-092130	0317		Correction of remaining errors for EGPRS2 after the split between BTS and MS requirements	9.0.0	9.1.0
2009-11	44	GP-092149	0319	1	Correction of remaining errors for MCBTS after the split between BTS and MS requirements	9.0.0	9.1.0
2009-11	44	GP-092318	0320	3	Addition of requirement to test intra BSS IM attenuation at maximum carrier frequency spacing	9.0.0	9.1.0
2009-11	44	GP-092467	0322	2	Correction of application of spurious emission requirements for MCBTS	9.0.0	9.1.0
2009-11	44	GP-092151	0323	1	Corrections of references	9.0.0	9.1.0
2009-11	44	GP-092335	0324	4	Corrections to minimum receiver requirements for Multi Standard BS in Annex P	9.0.0	9.1.0
2009-11	44	GP-092133	0327		Reference performance, LATRED, EGPRS and EGPRS2-A, DL	9.0.0	9.1.0
2009-11	44	GP-092136	0330	1	Removal of brackets, EGPRS2 MS requirements	9.0.0	9.1.0
2009-11	44	GP-091939	0339		Correction to GANSS Dynamic Range Requirements	9.0.0	9.1.0

2009-11	44	GP-092326	0340	1	GANSS minimum performance requirements – closing some open items in sensitivity scenarios	9.0.0	9.1.0
2009-11	44	GP-091997	0342		Correction of Nominal Error Rate (NER) requirements for GSM700	9.0.0	9.1.0
2009-11	44	GP-092412	0346	2	Correction to EGPRS2-A, 400 kHz ACI	9.0.0	9.1.0
2009-11	44	GP-092312	0348	1	EGPRS2-B uplink spectrum mask	9.0.0	9.1.0
2010-03	45	GP-100027	0352		Clarification to Satellite constellation and assistance data	9.1.0	9.2.0
2010-03	45	GP-100090	0355		EGPRS2 EVM requirements for repeater	9.1.0	9.2.0
2010-03	45	GP-100223	0358		Removal of brackets, LATRED, EGPRS2-A and miscellaneous corrections	9.1.0	9.2.0
2010-03	45	GP-100502	0368	1	Reference performance, EGPRS2-A USF, DL, Sensitivity, Co-channel and Adj-channel	9.1.0	9.2.0
2010-03	45	GP-100563	0370	1	Corrections and clarifications of the MCBTS requirements	9.1.0	9.2.0
2010-05	46	GP-100982	0350	3	Correction of exceptions of Spectrum due to modulation and wideband noise for MCBTS	9.2.0	9.3.0
2010-05	46	GP-101035	0363	4	Alignment of blocking requirements in multi-RAT operation and in GSM single-RAT operation for MSR equipment	9.2.0	9.3.0
2010-05	46	GP-101041	0372	3	A-GANSS Sensitivity & Dynamic range	9.2.0	9.3.0
2010-05	46	GP-100695	0375	1	Introduction of DL performance requirements for EGPRS2-B, Adjacent channel and RTTI/PAN	9.2.0	9.3.0
2010-05	46	GP-100795	0377		Alignment of definition and requirements for spurious emissions with CEPT/ERC/REC 74-01	9.2.0	9.3.0
2010-05	46	GP-100825	0379		Alignment of requirements for out-of-band spurious emissions with CEPT/ERC/REC 74-01	9.2.0	9.3.0
2010-05	46	GP-100696	0383	1	Clarification of adjacent timeslot levels	9.2.0	9.3.0
2010-05	46	GP-100699	0386	1	Numerous corrections	9.2.0	9.3.0
2010-05	46	GP-100993	0393		Alignment of inband frequency range for GSM 850 with other 3GPP access technologies	9.2.0	9.3.0
2010-05	46	GP-101038	0394	1	Introduction of requirements for spurious emission in frequency band 20	9.2.0	9.3.0
2010-09	47	GP-101625	0398	4	Introduction of VAMOS performance requirements	9.3.0	9.4.0
2010-09	47	GP-101539	0400	1	Clarification of multicarrier BTS receiver requirements	9.3.0	9.4.0
2010-11	48	GP-101831	0360	2	Reduction of the number of multicarrier BTS classes	9.4.0	9.5.0
2010-11	48	GP-101763	0408		DL reference performance requirements for EGPRS2-B, USF	9.4.0	9.5.0
2010-11	48	GP-101766	0411		DL reference performance requirements for EGPRS2-B – 2nd adjacent channel	9.4.0	9.5.0
2010-11	48	GP-101996	0414	1	Enhanced numbering of figures and tables	9.4.0	9.5.0
2010-11	48	GP-102047	0416	1	Clarification of the measurement of the spectrum exceptions in MCBTS	9.4.0	9.5.0
2011-03	49	GP-110423	0417	1	Corrections to A-GNSS values in Annex O	9.5.0	9.6.0
2011-03	49	GP-110141	0418		Correction of equipment types in receiver interference performance	9.5.0	9.6.0
2011-03	49	GP-110453	0421	1	Reference performance for MCS-0, Sensitivity and Co-channel	9.5.0	9.6.0
2011-03	49	GP-110424	0424	1	VAMOS uplink performance requirements	9.5.0	9.6.0
2011-03	49	GP-110229	0427		Corrections of the MCBTS IM requirements	9.5.0	9.6.0
2011-03	49	GP-110490	0428	1	VAMOS requirements for downlink performance definition	9.5.0	9.6.0
2011-03	49	GP-110487	0422	2	TIGHTER Performance requirements	9.6.0	10.0.0
2011-05	50	GP-110963	0431	3	Implicit relaxation of DARP-I requirements in DLDC configurations	10.0.0	10.1.0
2011-05	50	GP-110981	0435	1	Clarification of AM suppression receiver characteristics for multicarrier BTS equipped with multicarrier receiver	10.0.0	10.1.0
2011-05	50	GP-110947	0436	1	Clarification of receiver characteristics for multicarrier BTS equipped with multicarrier receiver	10.0.0	10.1.0
2011-05	50	GP-110983	0437	1	Clarification of blocking receiver characteristics for multicarrier BTS equipped with multicarrier receiver	10.0.0	10.1.0
2011-05	50	GP-110682	0439		Miscellaneous corrections for MCBTS	10.0.0	10.1.0
2011-05	50	GP-110688	0442		Clarification of the out-of-band emission principles for MCBTS	10.0.0	10.1.0
2011-05	50	GP-110926	0444	2	Correction for equipment types in VAMOS performance requirements	10.0.0	10.1.0

2011-05	50	GP-110892	0448	1	Reference performance for MCS-0, Sensitivity and Co-channel [removal of brackets]	10.0.0	10.1.0
2011-05	50	GP-110874	0450	1	Power versus time mask for AQPSK	10.0.0	10.1.0
2011-05	50	GP-110878	0453	1	Downlink performance requirements for VAMOS MS	10.0.0	10.1.0
2011-05	50	GP-110884	0456		Clarification of test cases for dual antenna terminals using legacy requirements	10.0.0	10.1.0
2011-05	50	GP-110958	0458	3	Uplink receiver performance requirements for VAMOS	10.0.0	10.1.0
2011-05	50	GP-110986	0463		Removal of VDTS-4	10.0.0	10.1.0
2011-09	51	GP-111299	0452	3	Clarification of the notation used for frequency offsets	10.1.0	10.2.0
2011-09	51	GP-111099	0466		Correction to reference interference performance for VAMOS I MS	10.1.0	10.2.0
2011-09	51	GP-111373	0468	1	EVM for AQPSK for Repeater	10.1.0	10.2.0
2011-09	51	GP-111300	0470	1	Correction of some VAMOS-II AHS7.4 RBERII values and a TCH/HS Rber1b typing error for GSM900 VDTS-3 SCPIR = +4dB	10.1.0	10.2.0
2011-09	51	GP-111380	0471	1	Interferer signal levels for TIGHTER	10.1.0	10.2.0
2011-09	51	GP-111158	0472		Clarification of references to TS 24.008	10.1.0	10.2.0
2011-09	51	GP-111295	0473	1	TIGHTER Performance requirements	10.1.0	10.2.0
2011-09	51	GP-111368	0475	1	Introduction of VDTS-4	10.1.0	10.2.0
2011-09	51	GP-111192	0477		Introduction of EVM requirements for AQPSK	10.1.0	10.2.0
2011-09	51	GP-111446	0479	1	Uplink receiver performance requirements for VAMOS	10.1.0	10.2.0
2011-09	51	GP-111462	0481	2	Clarification of applicability of requirements for spurious response frequencies for multicarrier receiver	10.1.0	10.2.0
2011-09	51	GP-111450	0483	1	Reference control channel performance for VAMOS-II MS	10.1.0	10.2.0
2011-09	51	GP-111444	0485		VAMOS II performance requirements	10.1.0	10.2.0
2011-09	51	GP-111458	0487		Reference DTX performance requirements for VAMOS-II MS	10.1.0	10.2.0
2011-11	52	GP-111773	0489	1	On EVM requirements and SCPIR_DL in the case of AQPSK Modulation for Repeater	10.2.0	10.3.0
2011-11	52	GP-111742	0490	1	Correction of TIGHTER requirement errors	10.2.0	10.3.0
2011-11	52	GP-111743	0491	1	Update of TIGHTER EGPRS2-A requirements	10.2.0	10.3.0
2011-11	52	GP-111790	0492	1	Introducing SCH sensitivity TIGHTER requirements	10.2.0	10.3.0
2011-11	52	GP-111590	0494		Correction of VAMOS-II DL DTX requirements	10.2.0	10.3.0
2011-11	52	GP-111856	0496	2	Correction of VAMOS-II performance requirements	10.2.0	10.3.0
2011-11	52	GP-111613	0498		Correction of VDTS-4 signal levels	10.2.0	10.3.0
2011-11	52	GP-111620	0501		Correction to uplink receiver performance requirements for VAMOS and removal of brackets	10.2.0	10.3.0
2011-11	52	GP-111638	0504		Clarification on Normal BTS co-location blocking requirements	10.2.0	10.3.0
2011-11	52	GP-111745	0506		Removal of brackets for VAMOS BTS requirements	10.2.0	10.3.0
2012-03	53	GP-120075	0508		VAMOS-I DL performance requirements	10.3.0	10.4.0
2012-03	53	GP-120077	0510		Removal of VAMOS-II square brackets and reference correction	10.3.0	10.4.0
2012-03	53	GP-120079	0512		Correction of VAMOS-II DL control channel performance requirements	10.3.0	10.4.0
2012-03	53	GP-120101	0513		TIGHTER PDTCH BLER level clarification	10.3.0	10.4.0
2012-03	53	GP-120102	0514		TIGHTER – Removal of Square brackets for TCH and Control Channel requirements	10.3.0	10.4.0
2012-03	53	GP-120118	0516		Update of Reference clause with 3GPP TS 51.026, repeater RF conformance test specification	10.3.0	10.4.0
2012-03	53	GP-120171	0519		Removal of brackets for general receiver performance	10.3.0	10.4.0
2012-03	53	GP-120289	0523		Removal of VAMOS-I DL square brackets	10.3.0	10.4.0
2012-03	53	GP-120410	0525		Correction to VAMOS-II VDTS-4 performance requirements for TCH/AHS7.4 codec	10.3.0	10.4.0
2012-05	54	GP-120759	0526	1	TIGHTER - Removal of Square brackets for GPRS and EGPRS requirements	10.4.0	10.5.0
2012-05	54	GP-120603	0529		Removal of VAMOS-I DL square brackets	10.4.0	10.5.0
2012-05	54	GP-120656	0532		Correction of co-location blocking table	10.4.0	10.5.0
2012-05	54	GP-120751	0533	1	TIGHTER - FER / RBER unbalance corrections	10.4.0	10.5.0

History

Document history		
V10.0.0	April 2011	Publication
V10.1.0	June 2011	Publication
V10.2.0	October 2011	Publication
V10.3.0	January 2012	Publication
V10.4.0	March 2012	Publication
V10.5.0	July 2012	Publication