

ETSI TS 145 022 V14.0.0 (2017-04)



**Digital cellular telecommunications system (Phase 2+) (GSM);
GSM/EDGE Radio link management in hierarchical networks
(3GPP TS 45.022 version 14.0.0 Release 14)**



Reference

RTS/TSGR-0645022ve00

Keywords

GSM

ETSI

650 Route des Lucioles
F-06921 Sophia Antipolis Cedex - FRANCE

Tel.: +33 4 92 94 42 00 Fax: +33 4 93 65 47 16

Siret N° 348 623 562 00017 - NAF 742 C
Association à but non lucratif enregistrée à la
Sous-Préfecture de Grasse (06) N° 7803/88

Important notice

The present document can be downloaded from:
<http://www.etsi.org/standards-search>

The present document may be made available in electronic versions and/or in print. The content of any electronic and/or print versions of the present document shall not be modified without the prior written authorization of ETSI. In case of any existing or perceived difference in contents between such versions and/or in print, the only prevailing document is the print of the Portable Document Format (PDF) version kept on a specific network drive within ETSI Secretariat.

Users of the present document should be aware that the document may be subject to revision or change of status. Information on the current status of this and other ETSI documents is available at
<https://portal.etsi.org/TB/ETSIDeliverableStatus.aspx>

If you find errors in the present document, please send your comment to one of the following services:
<https://portal.etsi.org/People/CommiteeSupportStaff.aspx>

Copyright Notification

No part may be reproduced or utilized in any form or by any means, electronic or mechanical, including photocopying and microfilm except as authorized by written permission of ETSI.

The content of the PDF version shall not be modified without the written authorization of ETSI.
The copyright and the foregoing restriction extend to reproduction in all media.

© European Telecommunications Standards Institute 2017.
All rights reserved.

DECT™, **PLUGTESTS™**, **UMTS™** and the ETSI logo are Trade Marks of ETSI registered for the benefit of its Members.
3GPP™ and **LTE™** are Trade Marks of ETSI registered for the benefit of its Members and of the 3GPP Organizational Partners.
GSM® and the GSM logo are Trade Marks registered and owned by the GSM Association.

Intellectual Property Rights

IPRs essential or potentially essential to the present document may have been declared to ETSI. The information pertaining to these essential IPRs, if any, is publicly available for **ETSI members and non-members**, and can be found in ETSI SR 000 314: *"Intellectual Property Rights (IPRs); Essential, or potentially Essential, IPRs notified to ETSI in respect of ETSI standards"*, which is available from the ETSI Secretariat. Latest updates are available on the ETSI Web server (<https://ipr.etsi.org>).

Pursuant to the ETSI IPR Policy, no investigation, including IPR searches, has been carried out by ETSI. No guarantee can be given as to the existence of other IPRs not referenced in ETSI SR 000 314 (or the updates on the ETSI Web server) which are, or may be, or may become, essential to the present document.

Foreword

This Technical Specification (TS) has been produced by ETSI 3rd Generation Partnership Project (3GPP).

The present document may refer to technical specifications or reports using their 3GPP identities, UMTS identities or GSM identities. These should be interpreted as being references to the corresponding ETSI deliverables.

The cross reference between GSM, UMTS, 3GPP and ETSI identities can be found under <http://webapp.etsi.org/key/queryform.asp>.

Modal verbs terminology

In the present document "**shall**", "**shall not**", "**should**", "**should not**", "**may**", "**need not**", "**will**", "**will not**", "**can**" and "**cannot**" are to be interpreted as described in clause 3.2 of the [ETSI Drafting Rules](#) (Verbal forms for the expression of provisions).

"**must**" and "**must not**" are **NOT** allowed in ETSI deliverables except when used in direct citation.

Contents

Intellectual Property Rights	2
Foreword.....	2
Modal verbs terminology.....	2
Foreword.....	6
1 Scope	7
2 References	7
3 Abbreviations	7
4 General	7
5 Hierarchical networks.....	8
5.1 General	8
5.2 Cell types.....	8
5.2.1 Large cells.....	8
5.2.2 Small cells.....	8
5.2.3 Microcells	8
6 Idle mode procedures	9
7 Examples of handover and RF power control algorithms	9
7.1 General	9
Annex A (informative): Example 1 (Siemens AG).....	10
A.1 Introduction	10
A.2 Functional requirements.....	10
A.3 BSS pre-processing and threshold comparisons.....	11
A.3.1 Measurement averaging process.....	11
A.3.2 Handover threshold comparison process.....	11
A.4 BSS decision algorithm.....	12
A.5 Additional O&M parameters stored for handover purposes in hierarchical networks.....	12
A.6 Bibliography.....	13
Annex B (informative): Example 2 (DeTeMobil)	14
B.1 Introduction	14
B.2 Definitions.....	14
B.2.1 Categories of cells	14
B.2.2 Classification of MS in connected mode.....	15
B.2.2.1 Classification in the lower layer	15
B.2.2.2 Classification in the middle layer or the upper layer	15
B.2.2.3 Loss of the "slow MS" or "quasi-stationary MS" status	16
B.3 Power Control Algorithm.....	16
B.3.1 MS connected over a cell of the lower layer	16
B.3.2 MS connected over a cell of the middle layer or the upper layer	16
B.4 Handover algorithm in a hierarchical cell structure	16
B.4.1 MS connected over a cell of the lower layer	16
B.4.2 MS connected over a cell of the middle layer or the upper layer	17
B.4.3 Handover at borders of different cell structures	17
B.5 O&M-Parameter.....	17
B.6 State diagrams	18

Annex C (informative):	Example 3 (Alcatel)	20
C.1	General description.....	20
C.1.1	Speed discrimination.....	20
C.2	Handover causes.....	21
C.2.1	Emergency causes.....	21
C.2.2	Better cell causes.....	21
C.3	Dwell time in lower layer cells:.....	21
C.3.1	Serving cell = lower layer cell.....	21
C.3.2	Serving cell = upper layer cell.....	21
C.3.3	Mechanism of increasing / decreasing tdwell.....	21
C.4	Speed discrimination process:.....	22
C.4.1	Serving cell = upperlayer cell.....	22
C.4.2	Serving cell = lower layer cell.....	22
C.5	Representation of handovers.....	23
C.5.1	Ideal behaviour: target cells are available.....	23
C.5.2	Real behaviour: target cells may not be available.....	23
C.6	Emergency handover.....	24
C.6.1	Target cell = upper layer cell.....	24
C.7	Upper layer to lower layer cells handover.....	25
C.7.1	General principles.....	25
C.7.2	Homogeneity of speed discrimination in lower layer and upper layer cells.....	25
C.8	Minicells.....	25
C.8.1	Handover diagrams.....	25
C.9	O&M parameters.....	26
Annex D (informative):	Example 4 (France Telecom/CNET)	27
D.1	Introduction.....	27
D.2	Descriptions of the algorithm.....	28
D.3	Handover causes.....	28
D.3.1	emergency handover causes.....	28
D.3.2	mobile speeds estimation causes.....	28
D.4	Mobile speeds estimations.....	29
D.4.1	Estimation of the field strength variations.....	29
D.5	BSS decision algorithm.....	30
D.6	O&M parameters.....	30
D.7	Examples.....	31
D.8	State diagrams.....	34
D.8.1	Case of a three layers hierarchical network.....	34
D.8.2	Case of a two layers hierarchical network.....	35
Annex E (informative):	Simulation Model for Handover Performance Evaluation in Hierarchical Cell Structures	37
E.1	Introduction.....	37
E.2	Mobile Environment.....	37
E.3	Radio Network Model.....	37
E.3.1	Scenario 1: Hot Spot.....	37
E.3.2	Scenario 2: Line of Cells.....	38
E.3.3	Scenario 3: Manhattan Coverage.....	38
E.4	Propagation Model.....	38

E.4.1	Upper Layer Path Loss	38
E.4.1.1	Macrocells.....	38
E.4.1.2	Small cells.....	39
E.4.2	Lower Layer Path Loss.....	40
E.4.2.1	Line-of-sight Case	40
E.4.2.2	Non Line-of-sight Case.....	41
E.4.2.3	Shape of the level with the proposed path loss model	41
E.4.3	Fading.....	42
E.5	Motion Model.....	42
E.6	Handover Algorithms	43
E.7	Measurement Reporting	43
E.8	Performance Criteria	43
E.9	Open Issues	43
Annex F (informative):	Change history	44
History		45

Foreword

This Technical Specification has been produced by the 3rd Generation Partnership Project (3GPP).

The contents of the present document are subject to continuing work within the TSG and may change following formal TSG approval. Should the TSG modify the contents of the present document, it will be re-released by the TSG with an identifying change of release date and an increase in version number as follows:

Version x.y.z

where:

- x the first digit:
 - 1 presented to TSG for information;
 - 2 presented to TSG for approval;
 - 3 or greater indicates TSG approved document under change control.
- y the second digit is incremented for all changes of substance, i.e. technical enhancements, corrections, updates, etc.
- z the third digit is incremented when editorial only changes have been incorporated in the document.

1 Scope

The present document gives examples for the Radio sub-system link control to be implemented in the Base Station System (BSS) and Mobile Switching Centre (MSC) of the GSM and DCS 1 800 systems in case hierarchical cell structures are employed.

Unless otherwise specified, references to GSM also include DCS 1 800, and multiband systems if operated by a single operator.

2 References

The following documents contain provisions which, through reference in this text, constitute provisions of the present document.

- References are either specific (identified by date of publication, edition number, version number, etc.) or non-specific.
- For a specific reference, subsequent revisions do not apply.

For a non-specific reference, the latest version applies. In the case of a reference to a 3GPP document (including a GSM document), a non-specific reference implicitly refers to the latest version of that document *in the same Release as the present document*.

- [1] 3GPP TS 03.22 (ETS 300 930): "Functions related to Mobile Station (MS) in idle mode and group receive mode".
- [2] 3GPP TR 03.30 (ETR 364): "Radio network planning aspects".
- [3] 3GPP TS 45.008: "Radio subsystem link control".
- [4] 3GPP TR 01.04 (ETR 350): "Abbreviations and acronyms".

3 Abbreviations

Abbreviations used in the present document are listed in 3GPP TR 01.04 [4].

4 General

ETS 300 911 (GSM 05.08 [3]) specifies the radio sub system link control implemented in the Mobile Station (MS), Base Station System (BSS) and Mobile Switching Centre (MSC) of the GSM and DCS 1 800 systems of the European digital cellular telecommunications system (Phase 2).

The present document gives several examples of how the basic handover and RF power control algorithm as contained in (informative) annex A to ETS 300 911 [3] can be enhanced to cope with the requirements on the radio subsystem link control in hierarchical networks.

A hierarchical network is a network consisting of multiple layers of cells, allowing for an increased traffic capacity and performance compared to a single layer network.

The radio sub-system link control aspects that are addressed are as follows:

- Handover;
- RF Power control.

5 Hierarchical networks

5.1 General

In a hierarchical, or microcellular network, traffic is supported on multiple layers of cells. Typically, a network operator could implement a layer consisting of microcells as a second layer in his existing network consisting of large or small cells. The addition of this second layer would improve the capacity and coverage of his network.

In the present document the following naming convention is used for the different layers. For a network consisting of three layers the layer using the biggest cells is the "upper layer", followed by the "middle layer", and then the "lower layer" which has the smallest cells. For a network consisting of two layers, only "upper layer" and "lower layer" are used.

The intention in a hierarchical network is to use the radio link control procedures to handle the majority of the traffic in the lower layer, i.e. the smallest cells, as this will limit interference and therefore improve the frequency reuse.

However, a part of the traffic cannot always efficiently be handled in the lower layer. Examples are cases where the MS is moving fast (relative to the cell range), or where the coverage is insufficient, or where a cell to make a handover to on the same level may not be available fast enough (going around corners, entering/leaving buildings).

5.2 Cell types

GSM 03.30 [2] distinguishes between three kinds of cells: large cells, small cells and micro cells. The main difference between these kinds lies in the cell range, the antenna installation site, and the propagation model applying:

5.2.1 Large cells

In large cells the base station antenna is installed above the maximum height of the surrounding roof tops; the path loss is determined mainly by diffraction and scattering at roof tops in the vicinity of the mobile i.e. the main rays propagate above the roof tops; the cell radius is minimally 1 km and normally exceeds 3 km. Hata's model and its extension up to 2 000 MHz (COST 231-Hata model) can be used to calculate the path loss in such cells (GSM 03.30 [2] annex B).

5.2.2 Small cells

For small cell coverage the antenna is sited above the median but below the maximum height of the surrounding roof tops and so therefore the path loss is determined by the same mechanisms as stated in subclause 5.1.1. However large and small cells differ in terms of maximum range and for small cells the maximum range is typically less than 1-3 km. In the case of small cells with a radius of less than 1 km the Hata model cannot be used.

The COST 231-Walfish-Ikegami model (see GSM 03.30 [2] annex B) gives the best approximation to the path loss experienced when small cells with a radius of less than 5 km are implemented in urban environments. It can therefore be used to estimate the BTS ERP required in order to provide a particular cell radius (typically in the range 200 m - 3 km).

5.2.3 Microcells

COST 231 defines a microcell as being a cell in which the base station antenna is mounted generally below roof top level. Wave propagation is determined by diffraction and scattering around buildings i.e. the main rays propagate in street canyons. COST 231 proposes an experimental model for microcell propagation when a free line of sight exists in a street canyon (see GSM 03.30 [2]).

The propagation loss in microcells increases sharply as the receiver moves out of line of sight, for example, around a street corner. This can be taken into account by adding 20 dB to the propagation loss per corner, up to two or three corners (the propagation being more of a guided type in this case). Beyond, the complete COST231-Walfish-Ikegami model as presented in annex B of GSM 03.30 [2] should be used.

Microcells have a radius in the region of 200 to 300 metres and therefore exhibit different usage patterns from large and small cells.

6 Idle mode procedures

GSM 03.22 [1] outlines how idle mode operation shall be implemented. Further details are given in Technical Specifications GSM 04.08 and GSM 05.08 [3].

A useful feature for hierarchical networks is that cell prioritization, for Phase 2 MS, can be achieved during cell reselection by the use of the reselection parameters optionally broadcast on the BCCH. Cells are reselected on the basis of a parameter called C2 and the C2 value for each cell is given a positive or negative offset (CELL_RESELECT_OFFSET) to encourage or discourage MSs to reselect that cell. A full range of positive and negative offsets is provided to allow the incorporation of this feature into already operational networks.

The parameters used to calculate C2 are as follows:

- a) CELL_RESELECT_OFFSET;
- b) PENALTY_TIME;

When the MS places the cell on the list of the strongest carriers as specified in GSM 05.08 [3], it starts a timer which expires after the PENALTY_TIME. This timer will be reset when the cell is taken off the list. For the duration of this timer, C2 is given a negative offset. This will tend to prevent fast moving MSs from selecting the cell.

- c) TEMPORARY_OFFSET;

This is the amount of the negative offset described in (ii) above. An infinite value can be applied, but a number of finite values are also possible.

The permitted values of these parameters and the way in which they are combined to calculate C2 are defined in GSM 05.08 [3].

7 Examples of handover and RF power control algorithms.

7.1 General

In the following annexes four examples of handover and power control algorithms are presented. All of these are considered sufficient to allow successful implementation in hierarchical or microcellular networks. None of these solutions is mandatory.

The "**Description of algorithm**" of each annex, contains a text as provided by the authors of the algorithm. Any discussion on the algorithms is contained in a separate clause, "**Discussion of algorithm**".

Annex A (informative): Example 1 (Siemens AG)

Description of algorithm

Source: Siemens AG

Date: 23.08.95

Subject: Fast Moving Mobiles

A.1 Introduction

This annex specifies an enhanced handover algorithm that may be implemented in GSM or DCS 1 800 hierarchical networks. In accordance with clause 5 of this annex a hierarchical network is understood as a network utilizing large cells for the upper layer for wide area coverage, and a lower layer structure of small or micro cells for capacity reasons. For the sake of simplicity the algorithm is described for hierarchical networks consisting of two layers. Nevertheless the algorithm can be extended to a hierarchy comprising several layers.

The algorithm is based upon the basic handover process, as described in GSM 05.08 [3], annex A. Only differences and supplements to the standard algorithms are explicitly described.

The aim of this annex is to show, how in hierarchical networks useless handovers can be avoided by allocating the mobiles, according to their speed, to the appropriate cell type. This goal is achieved by steering the fast mobile stations to the upper layer structure (e.g. large cells), while ensuring that slow mobile subscribers are served by the lower layer structure (e.g. small or micro cells). A mobile station is considered as fast, if its sojourn time in a cell is short compared to a mean call holding time.

An important aspect of this advanced algorithm is, that there is no implication on the MS type. The procedures described in this annex, work in the same manner for Phase 2 as well as Phase 1 MS types.

A more comprehensive description of the advanced algorithm along with some investigation results based on handover emulations in typical mixed cell scenarios is given in "Mobile Speed Sensitive Handover in a Mixed Cell Environment" (see Bibliography).

A.2 Functional requirements

The present algorithm is based on the following additional assumptions:

- the upper layer structure (e.g. large cells) provides a contiguous wide area coverage for all MS power classes to be supported by the network;
- the lower layer structure (e.g. small or micro cells) is fully embedded in the coverage area of upper layer structure (e.g. large cells);
- the algorithm is based on both a power budget and absolute level criterion. Therefore both criteria shall be enabled simultaneously, giving a higher priority to the absolute level criterion.

A.3 BSS pre-processing and threshold comparisons

A.3.1 Measurement averaging process

In a mixed cell environment one should take into account the different propagation conditions in large and small or micro cells, and the requirement for speeding up the handover decision, when a handover out of a small cell is pending (especially, with the street corner effect in micro cells), an excessive delay of the handover detection can cause a loss of the connection. Regarding this, the following items are recommended:

- a) apply different values for the averaging parameters in large and small or micro cells, respectively;
- b) define separate averaging parameters applicable to RXLEV and RXLEV_NCELL(n), respectively;
- c) the BSS shall evaluate the Power Budget PBGT(n) using the averaging process defined for RXLEV_NCELL(n).

A.3.2 Handover threshold comparison process

The Handover threshold comparison process is similar to the process described in GSM 05.08 [3], annex A, except for section e) in A.3.2.2, which is modified as follows:

- e) Comparison of PBGT(n) with the variable hysteresis margin HO_MARGIN_TIME(n). If the process is employed, the action to be taken is as follows:

If $PBGT(n) > HO_MARGIN_TIME(n)$ a handover, cause PBGT(n), might be required.

In a hierarchical network this comparison enables handover into the lower layer structure (e.g. small or micro cells) to be performed for slow mobile stations, while fast-moving ones remain served by the upper layer structure (e.g. large cells).

The variable hysteresis margin is defined by:

$$HO_MARGIN_TIME(n) = HO_MARGIN(n) + HO_STATIC_OFFSET(n) - HO_DYNAMIC_OFFSET(n) * H(T(n) - DELAY_TIME(n)).$$

In addition to the HO_MARGIN(n) as defined in table A.1 of GSM 05.08 [3] except that the range has been extended to (-24, 24 dB), the variable hysteresis margin comprises:

- a static offset, HO_STATIC_OFFSET(n);
- a dynamic offset, HO_DYNAMIC_OFFSET(n); and
- a delay time interval, DELAY_TIME(n).

The parameters are related to cells of the lower layer structure only.

T(n) is the time that has elapsed since the point at which the mobile station has entered the coverage area of cell n in the lower layer structure.

The function H(x) is defined by:

$$H(x) = \begin{cases} 0 & \text{for } x < 0 \\ 1 & \text{for } x \geq 0 \end{cases}, \text{ with } x = T(n) - DELAY_TIME(n).$$

The simultaneous fulfilment of the following conditions indicates that the mobile station has entered the coverage area of cell n in the lower layer structure:

Condition 1: $RXLEV_NCELL(n) > RXLEV_MIN(n) + \text{Max}(0, P_a)$

Condition 2: $PBGT(n) > HO_MARGIN(n)$,

where $P_a = MS_TXPWR_MAX(n) - P$.

If both conditions are true, a timer $T(n)$ shall be started. If any of these conditions gets false, before the timer expiry, the timer shall be stopped and reset.

NOTE 1: $HO_MARGIN_TIME(n) = HO_MARGIN(n) + HO_STATIC_OFFSET(n)$ for those cells of the lower layer structure, whose timer has not yet been started or is still running. A high value of HO_STATIC_OFFSET effectively prevents a handover into the respective cell of the lower layer structure during the run time of the timer for that cell.

NOTE 2: $HO_MARGIN_TIME(n) = HO_MARGIN(n) + HO_STATIC_OFFSET(n) - HO_DYNAMIC_OFFSET(n)$

for those cells of the lower layer structure, whose timer has expired. This is the margin fixing the cell borders and replacing the usual $HO_MARGIN(n)$ within the standard handover of GSM 05.08 [3], annex A.

On timer expiry the reduced $HO_MARGIN_TIME(n)$ allows for a power budget handover into a cell of the lower layer structure for a slow moving mobile which is expected to be still in the coverage area of that cell.

On the contrary, a fast moving mobile is expected to have left the coverage area of an embedded cell of the lower layer structure while the timer for that cell is still running and therefore Condition 1 or 2 (or both) will be violated, thus preventing a handover request for a fast moving mobile into that cell of the lower layer structure. Consequently, fast moving mobiles are kept on the upper layer structure.

NOTE 3: A fast moving mobile connected to a cell of the lower layer structure (e.g. a phase 1 mobile being not able to run the reselection algorithm in idle mode or a mobile having changed its speed) is steered to the upper layer structure by requesting for it a rescue handover based on the absolute level criterion.

NOTE 4: $HO_MARGIN(n)$ defines the location of timer start. Choosing small or even negative values results in an early timer start and thereby avoiding cell border displacement and interference problems. Setting $HO_MARGIN(n)$ to large negative values effectively cancels Condition 2, and consequently the timer start is triggered only by Condition 1 such that the cell borders on the lower layer structure are independent of the cell site positions with respect to the cell sites in the upper layer structure.

A.4 BSS decision algorithm

The BSS decision algorithm described in GSM 05.08 [3], annex A, may be employed after replacing $HO_MARGIN(n)$ by the corresponding $HO_MARGIN_TIME(n)$ in equation (2) of annex A. In combination with suitable parameter settings this results in the mobile speed sensitive handover functionality referenced above.

A.5 Additional O&M parameters stored for handover purposes in hierarchical networks

HO_STATIC_OFFSET(n) A parameter used to apply a positive offset to $HO_MARGIN(n)$ in order to prevent a handover request into cell n of the lower layer structure.

Range: 0 - 127 dB

Step Size: 1 dB.

Admin. for: $HO_STATIC_OFFSET(n)$ for each neighbour cell of the lower layer structure ($n = 1 - 32$)

HO_DYNAMIC_OFFSET(n) A parameter used to partially or fully compensate the **HO_STATIC_OFFSET(n)** for cell n of the lower layer structure. This parameter gets active after the time interval **DELAY_TIME(n)**.

Range: 0 - 127 dB

Step Size: 1 dB.

Admin. for: **HO_DYNAMIC_OFFSET(n)** for each neighbour cell of the lower layer structure (n = 1 - 32)

DELAY_TIME(n) Time interval used to delay the handover decision into cell n of the lower layer structure to enable differentiation between fast and slow mobile stations in the handover decision process.

Range: 0 - 255 T_{sacch}

Step Size: 1 T_{sacch}

Admin. for: **DELAY_TIME(n)** for each neighbour cell of the lower layer structure (n = 1 - 32)

NOTE: These parameters apply only for cells of the lower layer structure.

A.6 Bibliography

- 1) K. Ivanov, G. Spring, "Mobile Speed Sensitive Handover in a Mixed Cell Environment", in Proc. IEEE 45th Veh. Technol. Conf., VTC 1995, pp. 892-896.

Annex B (informative): Example 2 (DeTeMobil)

Description of algorithm

Source:	DeTeMobil
Date:	21.08.1995
Subject:	High speed MS

B.1 Introduction

In order to provide significantly more traffic capacity in GSM networks, the average cell size has to become smaller. The reduction in cell size, however, should neither limit the mobility of the MS nor the MS speed. On the one hand problems will occur if the MS are so fast, that the time they stay in a small cell is too short for the radio link control procedures to be carried out efficiently and effectively and on the other hand if it is necessary to handover a MS to predetermined target cells very quickly if the received RF signal level of a radio connection is changing rapidly in a radio environment of small cells.

To give good performance to all MS, the network has to be built up using cells of different sizes at one place, i.e. a hierarchical cell structure. The network provides a multi-coverage. Dependent on the MS speed, the MS shall be handled by a cell with a suitable size.

The procedures to achieve this for an MS in idle mode are described in GSM 03.22 [1].

The radio link control procedures in the concept of a hierarchical cell structure are independent of the connections to MSC and BSC.

In the following the procedures to handle MS in connected mode for a hierarchical cell structure are given.

B.2 Definitions

B.2.1 Categories of cells

A hierarchical cell structure is built up from different layers of cells. The structure shall allow at least three layers: the lower layer, the middle layer and the upper layer(see note). If only two layers are planned, the lower layer and middle layer are used. It is emphasized that the relation to other cells determines the assignment to a layer in the hierarchical cell structure. The absolute size of a cell is not a criterion.

NOTE 1: An example for the use of middle and upper layer is as follows:

- Middle layer: Layer with sufficient capacity to handle the traffic for fast moving MS.
- Upper layer: "Umbrella Cells" of the middle layer, here only handover traffic shall be supported, when cells of the middle layer are not available.

The layer to which a cell in a hierarchical cell structure is assigned is set by the O&M-parameter CELL_LEVEL.

Cells that do not belong into a hierarchical structure (single layer) have the CELL_LEVEL "standard layer" that is the default level if details concerning the CELL_LEVEL are missing.

The parameter CELL_LEVEL has a range from 0 to 15(see note) and is allocated for each radio cell. The coding is given in clause B.5. In each radio cell the own level, and the levels for all neighbour cells, as in the BA(SACCH), are known.

NOTE 2: Possible reasons to introduce new layers may be: pico cells, specific services supported only in one layer, multiband systems etc.

B.2.2 Classification of MS in connected mode

For radio link control purposes in a hierarchical cell structure, an MS in connected mode is classified by a set of at least eight] status-fields. The set is called MS_STATUS. With one of these fields: MS_SPEED, MS are distinguished between "fast MS", "slow MS" and "quasi-stationary MS". All other fields of the set are for future use (see note)

NOTE: Possible details given in the fields that are for future use are: multiple band, GPRS, EFR etc..

MS_STATUS is used in decisions of the power control process.

At the establishment of an RR-connection MS_SPEED is set to the default value "fast MS", except for Phase 2 MS if establishment is in cells of the lower layer in which the path loss criterion C2 is activated. Then MS_SPEED is set to "slow MS".

The speed classification can be enabled/disabled by the flag EN_MS_SPEED.

If the flag EN_MS_SPEED is set to 0 (disabled) in a cell of the lower layer the classification is omitted, and the status of the MS in this cell will not be changed. At the establishment of an RR-connection all MS are set to the MS_SPEED default value "fast MS". During handover the MS shall keep the status of the previous cell.

In cells of the middle layer or the upper layer, all cells of the lower layer with the flag EN_MS_SPEED disabled, are excluded from the classification procedure as described in subclause B.2.2.2.

B.2.2.1 Classification in the lower layer

For each RR-connection supported by a cell of the lower layer a counter $C_{s(\text{tay})}$ is started. The counter C_s has an initial value 0, and is incremented by 1 with every SACCH-multiframe. When the value of counter C_s equals the threshold C_SLOW_STAT and the MS has MS_SPEED "fast MS", the MS MS_SPEED is set to "slow MS". If the value of the counter C_s satisfies the condition $C_s \leq C_QS_STAT$ the MS MS_SPEED is set from "slow MS" to "quasi-stationary MS".

Both parameters C_SLOW_STAT and C_QS_STAT are adjustable by O&M (see clause B.5), subject to the condition: $C_SLOW_STAT < C_QS_STAT$. It is envisaged that an adaptive procedure is developed for this adjustment to handle the inherent complexity of this procedure. The operator shall have the possibility to select between both the setting per O&M and by procedure.

The counter C_s is stopped and reset to 0 when the call is released or an intercell handover is performed. The counter shall go on in case of a successful intracell channel change. The MS_SPEED status of the MS is kept during handover or intracell channel change independent of where the handover is controlled (MSC or BSC).

B.2.2.2 Classification in the middle layer or the upper layer

During a call supported by a cell of the middle layer or the upper layer a counter $C_{a(\text{vailable})}(n)$ is started for each cell of the lower layer with the flag EN_MS_SPEED set to 1 (enabled), that is reported in the measurement reports, and fulfils the following equation:

$$RXLEV_NCELL(n) > RXLEV_MIN(n) + LAYER_HYST(n) + \text{Max}\{0, MS_TXPWR_MAX(n) - P\}$$

where n is the respective adjacent cell "n".

With every measurement report the counter $C_a(n)$ is incremented by 1 for each reported cell of the lower layer which still fulfils the inequation, otherwise $C_a(n)$ is decremented by 1. All counters $C_a(n)$ are stopped and reset to 0 when the call is finished in that cell.

When at least p (with $p = 1, \dots, 4$, see clause B.5) counters $C_a(n)$ reach the value $C_SLOW_STAT(n)$ the MS is estimated to be slow enough to be supported by cells of the lower layer. The MS MS_SPEED is set to "slow MS". A handover to a cell of the lower layer is initiated (see subclause B.4.2). The value $p = 1$ should be used as default value.

NOTE: $p \geq 1$ gives the possibility in special cases, where information on the velocity of MS is not reliable, e.g. in the surroundings of traffic lights, to tighten the requirement for the handover towards the lower layer of MS. $p=1$ is sufficient in most cases.

B.2.2.3 Loss of the "slow MS" or "quasi-stationary MS" status

During an RR-connection, when a handover from a cell of the lower layer to a cell of the middle layer or the upper layer is performed, the MS `MS_SPEED` is set to "fast MS". This happens when a handover with cause `RXLEV`, `RXQUAL` or distance occurs before the counter C_s reaches the value `C_SLOW_STAT`.

Furthermore, in the case that no radio resource is available in one of the higher layers, and the handover is performed to a cell of the lower layer, the MS `MS_SPEED` is set to "fast MS".

B.3 Power Control Algorithm

B.3.1 MS connected over a cell of the lower layer

In cells of the lower layer the power control algorithm shall be dependent on the MS `MS_SPEED`.

For a "fast MS" power control shall be [disabled]. The maximum allowed power level for that cell and for the class of MS has to be used by MS and BSS.

For MS with `MS_SPEED` "slow MS" or "quasi-stationary MS" the power control process as described in annex A of 05.08 [3] is used, with the following proviso:

In case of a MS with `MS_SPEED` "quasi-stationary MS" the power control ranges and the averaging periods are the same as used in the middle layer/upper layer or standard layer.

For MS with `MS_SPEED` "slow MS" the maximum allowed power in uplink and downlink may be reduced only by [five] 2 dB steps. For slow MS an separate set of power control parameters, for example for `POW_INCR/RED_STEP_SIZE` and `P_CON_INTERVAL` shall be used.

B.3.2 MS connected over a cell of the middle layer or the upper layer

For all MS connected via the middle- or upper layer the power control process as described in the 05.08 [3] are used.

B.4 Handover algorithm in a hierarchical cell structure

B.4.1 MS connected over a cell of the lower layer

After the successful establishment of an RR-connection in a cell of the lower layer, the counter C_s is started for this connection. In addition to the classification of MS (see subclause B.2.2), the counter is used to measure the time an MS stays in the cell of the lower layer.

If a handover with cause `RXLEV`, `RXQUAL` or distance occurs before C_s has reached the threshold `C_SLOW_STAT`, the handover is performed with preference to a cell of the middle layer. Only if no TCH is available in the middle layer, a cell of the upper layer is selected as handover-candidate. In case there is no cell or TCH available in the higher layers, the handover candidate shall be a cell from the lower layer. As long as the value of C_s is smaller than `C_SLOW_STAT` a handover cause `PBGT` is not possible.

When C_s is equal or greater than `C_SLOW_STAT` all handover types are possible to all cells of the lower layer regardless of the MS `MS_SPEED` ("slow MS" or "quasi-stationary MS"). If no cell of the lower layer is available for a forced handover, the handover candidate shall be a cell from the middle layer or in case of unavailability from the upper layer. Only under this condition the MS retains `MS_SPEED` "slow MS" or "quasi-stationary MS" during a handover from lower layer to either middle layer or upper layer. In case of a `PBGT`-handover, the handover candidate list may only contain cells from the lower layer.

B.4.2 MS connected over a cell of the middle layer or the upper layer

For RR-connections supported by cells of the middle layer or the upper layer a standard handover procedure as specified e.g. in annex A of 05.08 [3] is used with the additions and restrictions as follows.

The counter $C_a(n)$ that is started for each cell of the lower layer (see subclause B.2.2), is used to trigger a handover from an actual serving cell of a higher level to a cell of the lower layer.

When at least p counters $C_a(n)$ reach the value $C_SLOW_STAT(n)$ the MS is estimated to be slow enough, so that it can be supported by cells of the lower layer.

As long as the above condition is not fulfilled, the handover from a cell of the middle layer/upper layer to a cell of the lower layer is not allowed with the exception for the handover causes RXLEV, RXQUAL or DISTANCE that only the lower layer has free resources.

When $C_a(n)$ reaches the value $C_SLOW_STAT(n)$ for at least p cells of the lower layer, a handover is initiated towards the lower layer. All available cells of the lower layer are possible handover candidates. The handover shall be performed to that cell of the lower layer which has the best PBGT.

If the p -th counter $C_a(n)$ reaches the value $C_SLOW_STAT(n)$ at the same time that a handover cause PBGT is recognized, the PBGT-handover has to be performed.

B.4.3 Handover at borders of different cell structures

A border appears where an area with an hierarchical cell structure adjoins an area consisting of a single layer of cells.

For an MS that moves from the area with an hierarchical cell structure into the area with a single layer of cells, these cells of the standard layer are treated like cells of the middle layer.

In case of an MS moving from the single standard layer towards the hierarchical cell structure, for the purpose of radio link purposes there is no distinction between the cells of the hierarchical cell structure. This is because no information is available on the hierarchical structure in the standard layer.

B.5 O&M-Parameter

CELL_LEVEL	Hierarchy level of serving cell Range: 0 - 15 Step size: 1 Coding: 0: standardlayer 1: lower layer 2: middle layer 3: upper layer 4 - 15: for future use Used in: BSC Admin. for: CELL_LEVEL for each cell
CELL_LEVEL_NC(n)	Hierarchy level of n-th neighbour cell n: 1 - 32 Range: 0 - 15 Step size: 1 Coding: 0: standardlayer 1: lower layer 2: middle layer 3: upper layer 4 - 15: for future use Used in: BSC Admin. for: CELL_LEVEL_NC(n) for each adjacent cell n of a radio cell
EN_MS_SPEED	ENable classification of MS regarding SPEED Coding: 1: enable feature 0: disable feature

	Used in: BSC Admin. for: each cell
C_SLOW_STAT	Time an MS has to stay in a cell of the lower layer until MS_SPEED is set to "slow MS" Range: 0 - 255 T_{SACCH} Step Size: 1 T_{SACCH} Used in: BSC Admin. for: C_SLOW_STAT for each cell of the lower layer Conditions: 1. C_SLOW_STAT < C_QS_STAT 2. C_SLOW_STAT = C_SLOW_STAT(n) related to one cell
C_SLOW_STAT(n)	Time neighbour cell n of the lower layer has to be reported as suitable by an MS supported by the middle layer or upper layer until MS_SPEED is set to "slow MS" Range: 0 - 255 T_{SACCH} Step Size: 1 T_{SACCH} Used in: BSC Admin. for: C_SLOW_STAT(n) for each adjacent lower layer cell n of a middle layer or upper layer cell (n = 1 - 32) Conditions: 1. C_SLOW_STAT < C_QS_STAT 2. C_SLOW_STAT = C_SLOW_STAT(n) related to one cell
C_QS_STAT	Time an MS has to stay in a cell of the lower layer until MS_SPEED is set to "Quasi-stationary MS" Range: 0 - 510 T_{SACCH} Step Size: 2 T_{SACCH} Used in: BSC Admin. for: each cell Condition: C_QS_STAT > C_SLOW_STAT
LAYER_HYST(n)	Hysteresis for handover from the middle layer/upper layer to the lower layer Range: 0 - [31] dB Step Size: 1 dB Used in: BSC Admin. for: each neighbour cell
p	number of cells that has to fulfil the inequation to estimate an MS as slow Range: 1 - 4 Step Size: 1 Used in: BSC Admin. for: each cell of the middle layer or upper layer

B.6 State diagrams

Radio Resource Establishment:

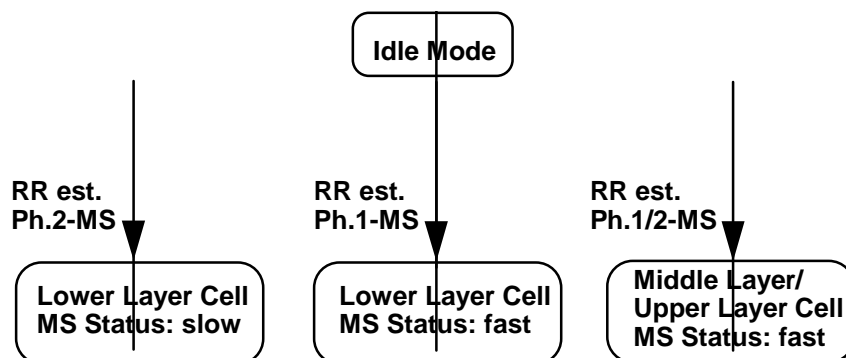

Handover Cases to the preferred cell layer:

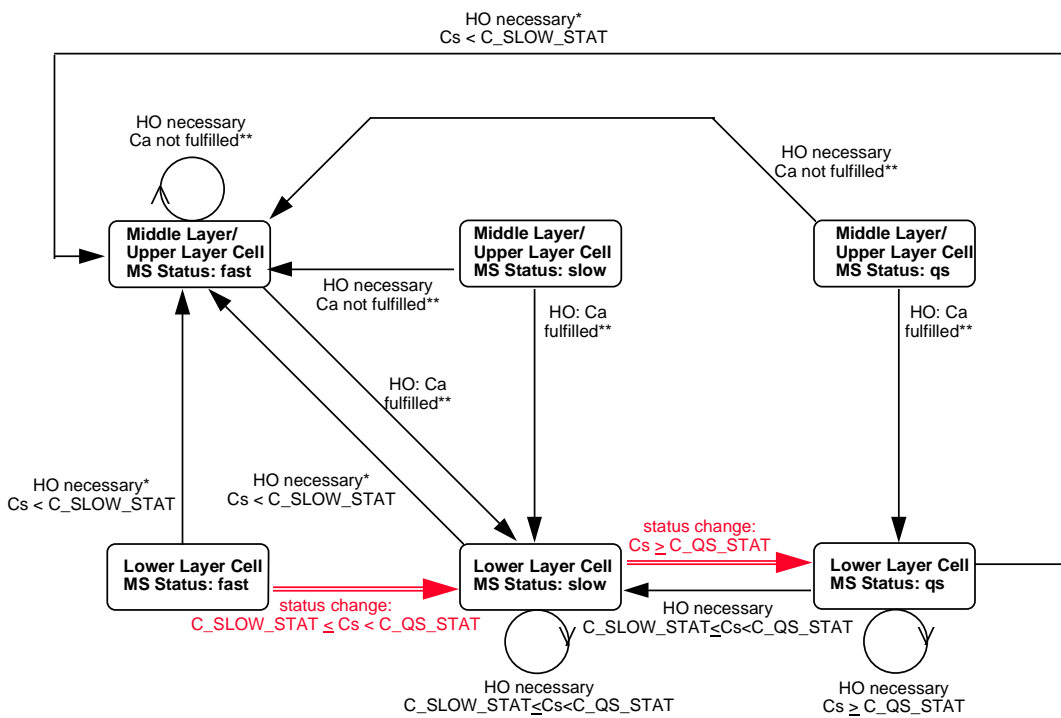

Notes:
 * all handover types except PBGT-HO
 ** Ca fulfilled: $Ca(n) \geq C_SLOW_STAT(n)$ for at least p cells

Handover Cases, that occur if no resources in the preferred cell layer are available:

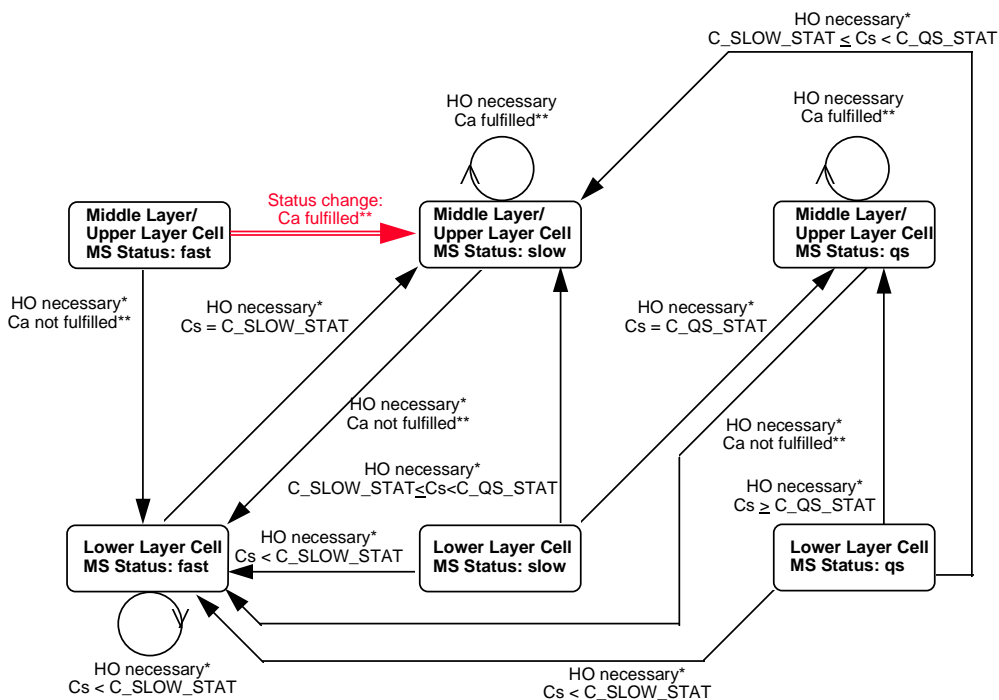

Notes:
 * all handover types except PBGT-HO
 ** Ca fulfilled: $Ca(n) \geq C_SLOW_STAT(n)$ for at least p cells

Annex C (informative): Example 3 (Alcatel)

Description of algorithm

C.1 General description

This annex describes a handover algorithm in hierarchical networks, i.e. with 2 layers of cells. The lower layer cells may be minicells or microcells, as expressed in the following figures.

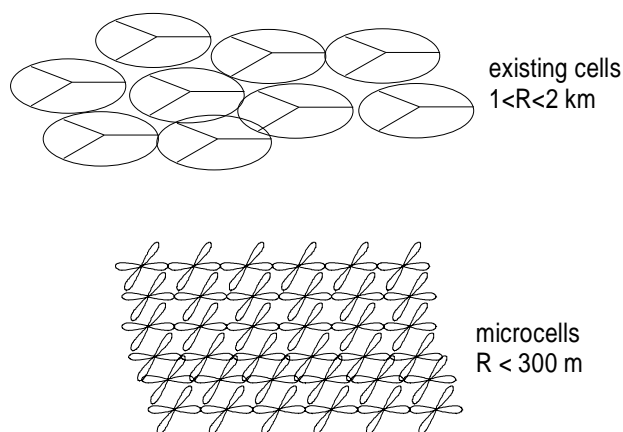

Figure C.1: First scenario: microcells below existing cells

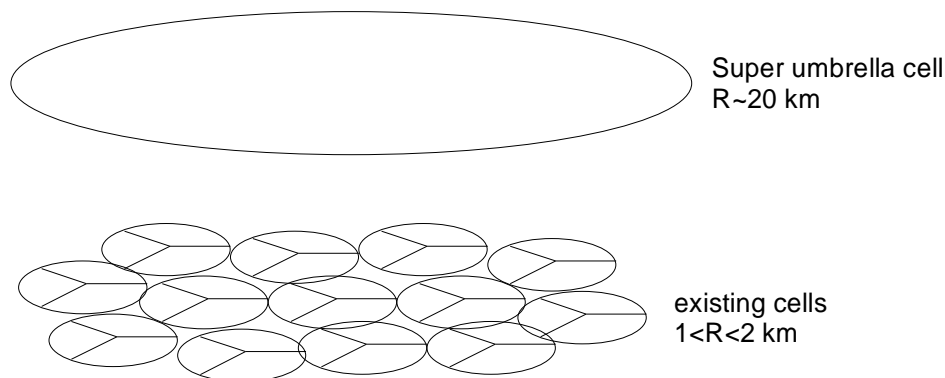

Figure C.2: Second scenario: "super umbrella cell" above existing minicells

This annex deals mainly with microcells below upper layer cells. The case of mini cells is expressed in clause C.8. The general philosophy of this algorithm is to handle a maximum of traffic in the lower layer cells. The upper layer cell is used as a "rescue" cell when a problem occurs. This will be detailed in clause C.6.

C.1.1 Speed discrimination

To avoid a high rate of handovers fast moving mobiles are sent and kept in the upperlayer cells. This speed discrimination is based on the dwell time of a mobile in a lower layer cell. A mobile handled by lower layer cells is sent to the upper layer cell if the delay between successive handovers becomes small. Furthermore a mobile handled by an upper layer cell is sent to a lower layer cell if it receives from this cell a high level of signal for a sufficient time. This is based on a "leaky bucket" mechanism which is described in clause C.3.

C.2 Handover causes

These causes are classified in two classes: **emergency** causes, which should remain exceptional and request a quick and safe reaction, and "**better cell**" causes.

C.2.1 Emergency causes

An emergency handover is due to a problem in the serving cell and a handover is necessary in a short delay in order not to loose the call. Emergency handover causes can be:

- too low quality on either direction (uplink or downlink),
- too low received level in either direction,
- distance too long.

This list is not necessarily exhaustive.

C.2.2 Better cell causes

A "better cell" handover is triggered when the call would be better handled by another cell, to optimize interferences, or reduce the signalling load of the network, or separate fast/slow moving mobiles. This list is not necessarily exhaustive.

Traditional "Better cell" causes are:

- PBGT - power budget for neighbour cell greater than a threshold. PBGT is checked only between cells of the same layer.
- Upper layer to lower layer cell - good received level in neighbour lower layer cell, with slow MS, when the serving cell is an upper layer cell.

The only cause which is described in details in the present document is the "upper layer to lower layer" cause which is new. The other ones are well known (see annex A of GSM 05.08 [3]) and are not described here.

C.3 Dwell time in lower layer cells:

The speed discrimination process is based on the dwell time in a lower layer cell. This time is expressed by $tdwell$ or by $cdwell$ (c for counter): $cdwell = 2 * tdwell$.

This relation comes from the fact that $tdwell$ (external parameter) is in seconds when $cdwell$ (internal parameter) is in SACCH frames.

C.3.1 Serving cell = lower layer cell

The observed dwell time is the dwell time in the serving cell: $tdwell(s)$ - s: serving cell, or $tdwell(0)$

C.3.2 Serving cell = upper layer cell

The dwell time is observed in each of the neighbour lower layer cells: $tdwell(n)$ - $1 \leq n \leq 64$

C.3.3 Mechanism of increasing / decreasing $tdwell$

- $tdwell(s)$
 $tdwell(s)$ starts at 0 when the call begins in the cell (after call set-up or intercell handover).

Each SACCH period $tdwell$ is incremented by 0.5.

$tdwell(s)$ is maintained after an intracell handover.

- $tdwell(n)$ - "Leaky bucket" mechanism

When a channel (SDCCH or TCH) is allocated in an upper layer cell (after call set-up or handover), the following process starts:

A counter $tdwell(n)$ is set to 0 for each neighbour cell n .

Each time a measurement result is received, for each of the declared n neighbour cells:

- If the reported raw received level $RXLEV_NCELL(n)$ of the $BTS(n)$ is above a threshold $L_RXLEV_OCHO(n)$, the counter $tdwell(n)$ is incremented by 0.5.
- Each time the received level is below this limit or no measurement is received, the counter $tdwell(n)$ is decreased by 0,5 with a minimum value of 0.

C.4 Speed discrimination process:

C.4.1 Serving cell = upperlayer cell

A handover is realized if the dwell time of a mobile in lower layer cell is above a threshold:

$tdwell(n) \geq MIN_DWELL_TIME$

This will forbid a fast moving mobile being sent to lower layer cell as the dwell time for each of the crossed cells never reaches the threshold. The handover is realized toward the lower layer cell which has triggered the handover cause.

C.4.2 Serving cell = lower layer cell

- Emergency handover:

Whatever the time elapsed in the serving cell, any emergency handover sends the call to the upper layer cell which is considered as a "rescue" cell.

- PBGT

Depending on the time elapsed in the serving cell, the call is transferred to the lower layer cell or to the upper layer cell.

If the dwell time in the serving cell is high enough ($tdwell(0) \geq MIN_CONNECT_TIME$), the mobile may be considered as a slow moving mobile and the call is sent to the lower layer cell which has triggered the cause.

If the dwell time is low (below the threshold), the mobile is considered as a fast moving mobile. To avoid a high number of handovers, the call is sent preferentially to the upper layer cell.

This test on the dwell time is realized only if there has already been a PBGT handover from another lower layer cell. This is to avoid sending a call to the upper layer cell in the following cases

- call initiated at the limit of the lower layer cell,
- call transferred from the upper layer cell to the lower layer cell just before reaching the limit of the lower layer cell,
- after external handover: no information on the precedent cell and on the handover cause. This will be the case for all interlayer handovers when both layers are provided by different manufacturers.

C.5 Representation of handovers

C.5.1 Ideal behaviour: target cells are available

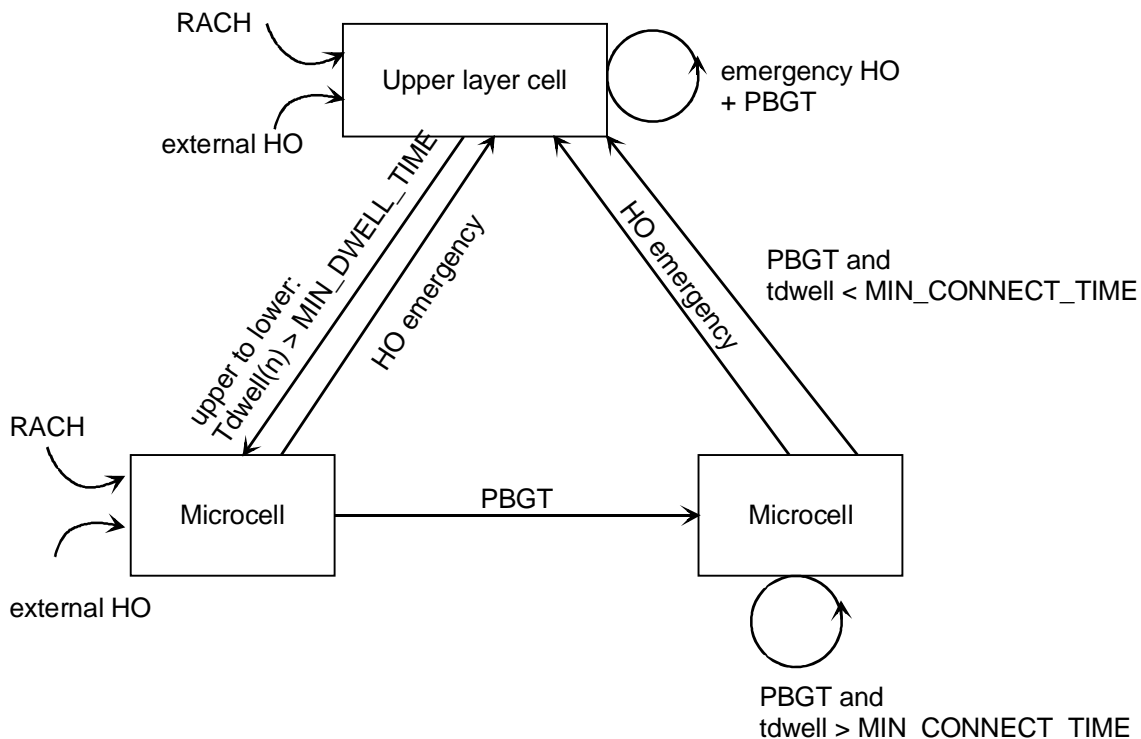

Figure C.3: Handovers in case of availability of the target cell

C.5.2 Real behaviour: target cells may not be available

The handover that may occur to non preferred target cells due to the unavailability of TCH resources are indicated with dotted line arrows in the state diagram.

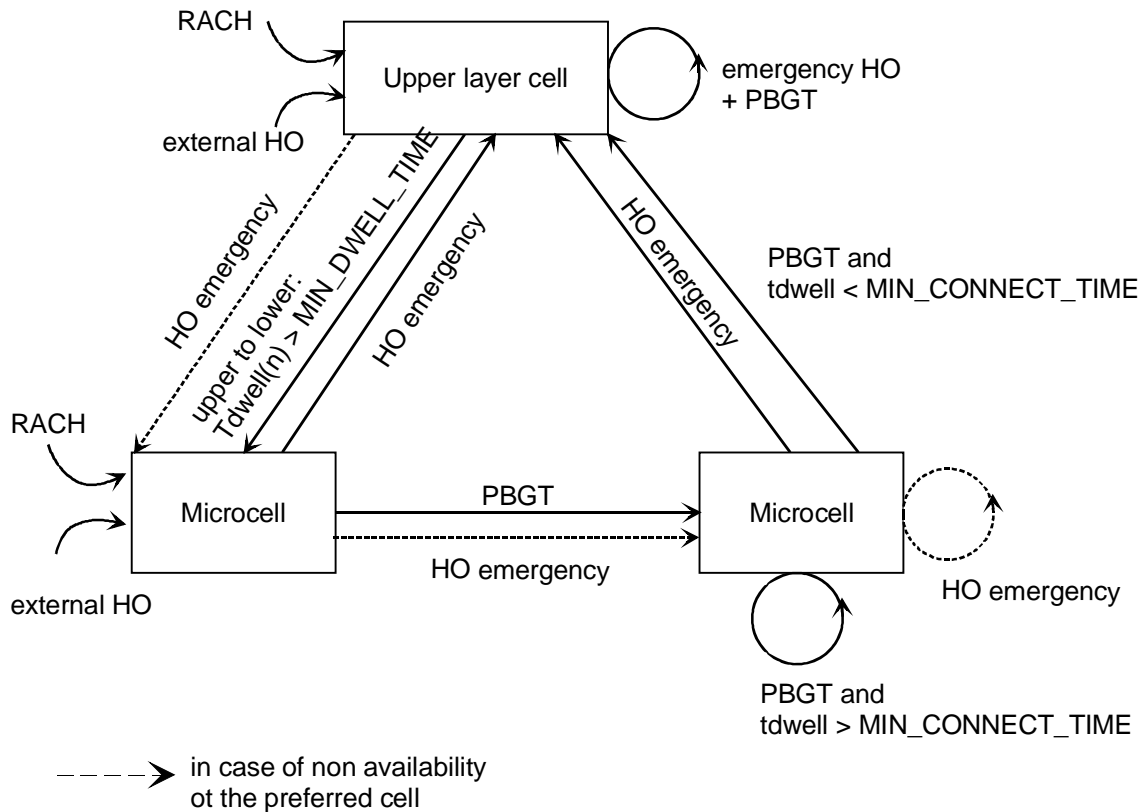

Figure C.4: state diagram

C.6 Emergency handover

C.6.1 Target cell = upper layer cell

When the serving cell is a microcell, the preferred target cell is always an upper layer cell. If another microcell was accepted as target cell, there would be an important risk to choose the wrong cell (the adjacent cell when the right one is the perpendicular cell) and thus to loose the call.

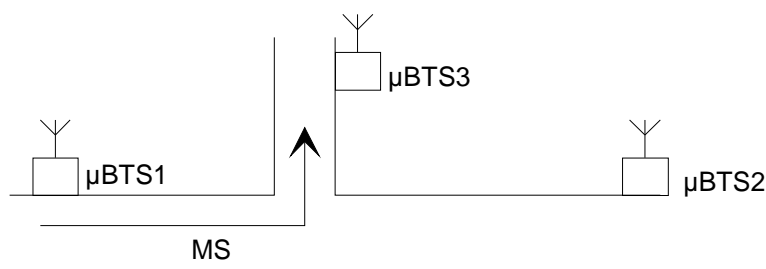

Figure C.5:

In the figure above, let us suppose that the mobile is initially connected to the μ BTS1. When it turns at the street corner, depending on its speed, there is a high probability it does not trigger a PBGT on the μ BTS 3 before detecting an emergency handover cause (crossing the high threshold). If a microcell was possible as a target cell, the μ BTS 2 would be chosen as the mobile receives good measurement reports from this cell for a while. The μ BTS 3 is either still not reported (due to the delay necessary in the mobile to get synchronization on a new cell), or reported for a short time with an insufficient average level.

The choice of μ BTS 2 is of course very bad.

C.7 Upper layer to lower layer cells handover

C.7.1 General principles

- based on the dwell time in a lower layer cell: it depends on the reported measurements from neighbour lower layer cells.

The counter used to estimate this dwell time is based on a "leaky bucket" mechanism, as described in clause C.3.

C.7.2 Homogeneity of speed discrimination in lower layer and upper layer cells

Theoretically the dwell time limit in a lower layer cell should be the same when this cell is the serving cell or the neighbour cell: $MIN_CONNECT_TIME = MIN_DWELL_TIME$.

To avoid Ping-Pong effect there must be the following relationship:

$$MIN_CONNECT_TIME \leq MIN_DWELL_TIME$$

This is to avoid the MS to be declared fast by the microcell and slow by the upper layer cell.

C.8 Minicells

With minicells there are some differences compared to microcells: there is no street corner effect. Thus there is no risk in sending a mobile to another minicell when an emergency handover is triggered. The diagram of handovers becomes the following:

C.8.1 Handover diagrams

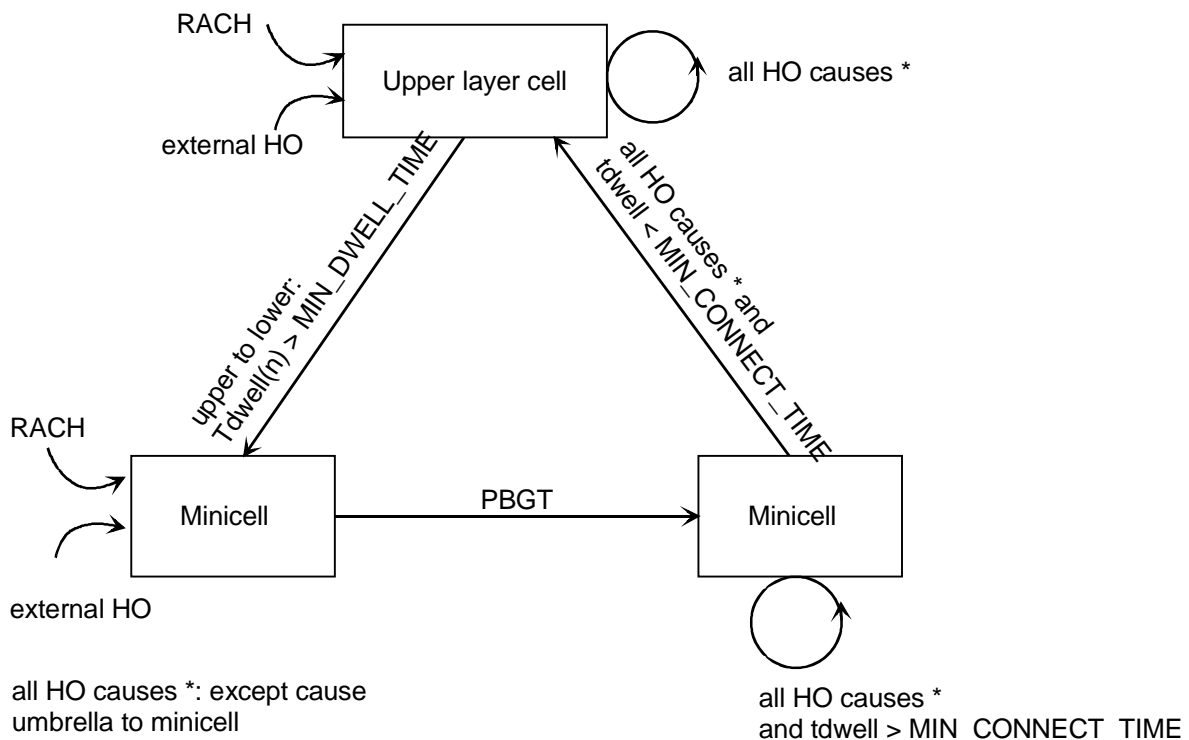

Figure C.6: Simplified handover diagram for minicells

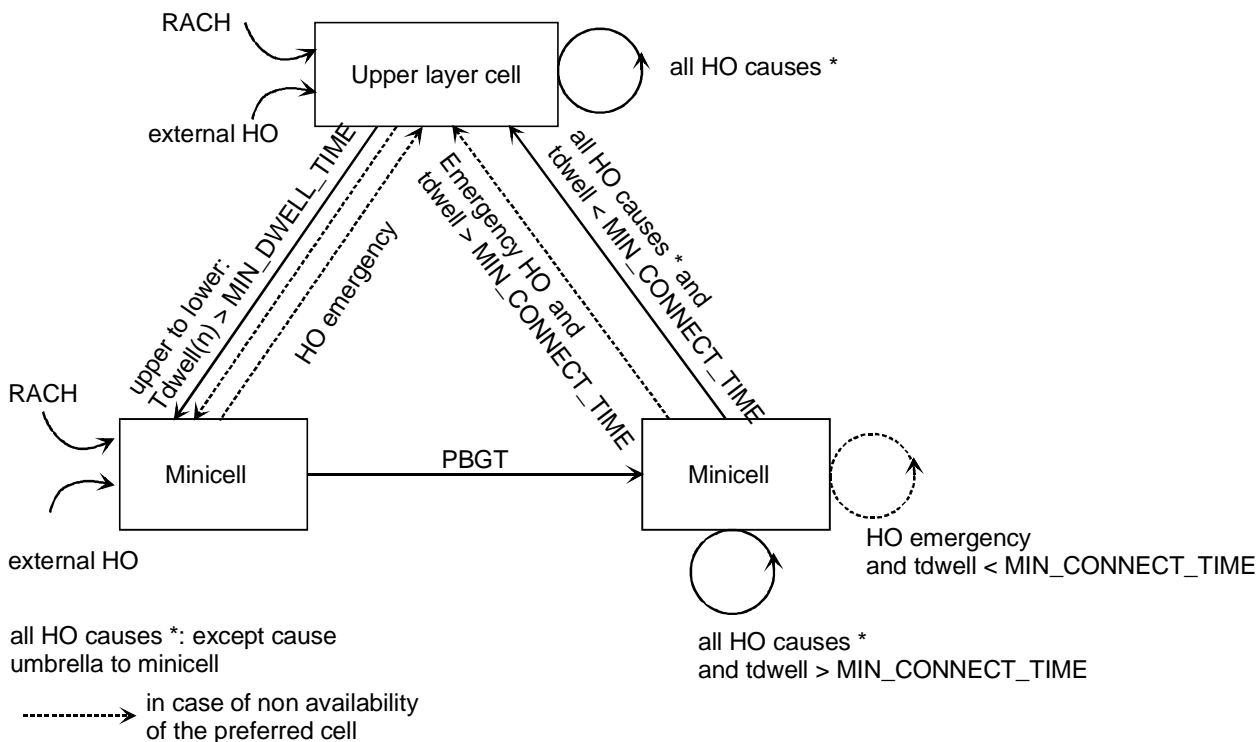

Figure C.7: Complete handover diagram for minicells

C.9 O&M parameters

- MIN_CONNECT_TIME:

Minimum time the mobile has to stay in the lower layer cell to be considered as slow, when the serving cell is the microcell.

- MIN_DWELL_TIME:

Value of the timer MIN_DWELL_TIME to send a call from an upper layer cell to a lower layer cell.

- L_RXLEV_OCHO(n):

Minimum receive LEVel on downlink for upper layer to neighbour lower layer Cell n HandOver.

Annex D (informative): Example 4 (France Telecom/CNET)

Description of algorithm

Source: France Telecom/CNET

Date: 22.06.95

Subject: Informative annex for high speed MS

D.1 Introduction

In order to increase the capacity of an existent GSM mobile network (composed with large cells), the total number of cell has to be increased and the average cell radius has to be decreased (-> small cells). If this solution is not sufficient to provide the required capacity, a hierarchical network can be developed by adding antenna on the streets. Such cells are called microcell and the corresponding layer is called lowerlayer.

Nevertheless to optimize the quality of service for high speed mobiles, large cells or small cells are still used as an overlayer which is called upperlayer.

The algorithm presented below (gradient algorithm) provides a mean to spread mobiles on the layers depending of their speed.

Figure D.1 features different kinds of cells and layers.

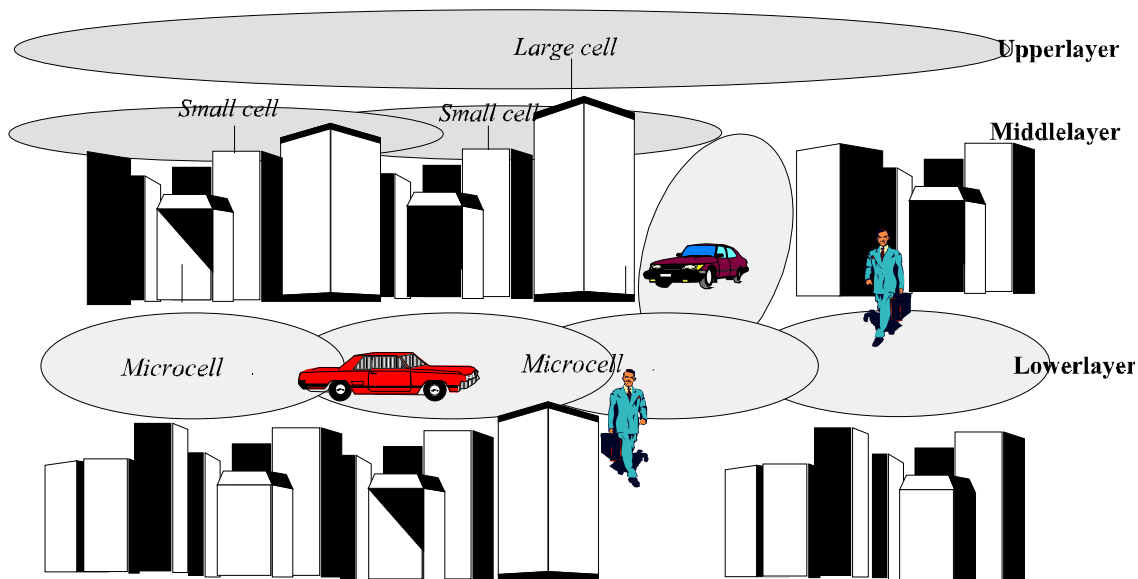

Figure D.1: Representation of the different kinds of cells and layers

In the case of a two layers hierarchical network, the uppest layer is called upperlayer whatever the type of its cells (large cell or small cell).

D.2 Descriptions of the algorithm

Mobile speed is estimated from the variation of the field strength received by the mobile from the target cell.

This method of estimation is based on the computation of the gradient between two averages of the field strength received by the mobile from the target cell (see subclause D.4.1 Estimation of the field strength variations). This algorithm can be used in any kind of multicellular network (composed with two layers or more than two layers).

Considering the case of a network composed with three layers.

A "fast" mobile connected to a cell of the lowerlayer must handover towards a cell of the middlelayer. Nevertheless the field strength received from the cell of the middlelayer must be high enough to trigger the handover.

A "slow" mobile connected to the lowerlayer must handover towards a cell of the same layer.

In both cases the estimation of mobile speeds are based on the field strength received from a cell of the lowerlayer.

A "fast" mobile connected to a cell of the upperlayer must handover towards a cell of the same layer.

A "slow" mobile connected to a cell of the upperlayer must handover to a cell of the middlelayer. In both cases the estimation of mobile speeds are based on the field strength received from a cell of the middlelayer.

A "fast" mobile connected to a cell of the middlelayer must handover towards a cell of the upperlayer. Nevertheless the field strength received from the cell of the upperlayer must be high enough to trigger the handover.

The estimation of mobile speeds are based on the field strength received from a cell of the middlelayer.

A "slow" mobile connected to a cell of the middlelayer must handover towards a cell of the lowerlayer. The estimation of mobile speeds are based on the field strength received from a cell of the lowerlayer

D.3 Handover causes

Some causes trigger emergency handovers, others trigger computations of the estimation of the mobile speed.

D.3.1 emergency handover causes

An emergency handover is performed as soon as the quality of service become too low (RXQUAL and RXLEV causes), the handover has to be fast and secured. Target cells are ordinated depending on the value of PBGT(n), nevertheless cells of the directly upper layer have priority.

ex: in a hierarchical network composed with two layers, emergency handovers in cells of the lowerlayer are performed in priority towards cells of the upperlayer.

- a) Comparison of RXLEV_XX with L_RXLEV_XX_H (XX = DL or UL)

$$RXLEV_XX < L_RXLEV_HH_H$$

- b) Comparison of RXQUAL_XX with L_RXQUAL_XX_H (XX = DL or UL)

$$RXQUAL_XX > L_RXQUAL_XX_H$$

D.3.2 mobile speeds estimation causes

Mobile speeds are estimated as soon as a non emergency handover is required. Two handover causes, whom depend of the target cell type, provide a computation of the estimation of mobile speeds.

A PBGT criteria is used in the case of a target cell of the same layer as the source one.

A CATCH criteria is used in the case of a target cell of a lower layer than the source one.

The PBGT(n) criteria is defined as in the appendix A of recommendation GSM 05.08 [3] i.e.:

$$1) \text{RXLEV_NCELL}(n) > \text{RXLEV_MIN}(n) + \text{Max}(0, P_a)$$

where $P_a = (\text{MS_TXPWR_MAX}(n) - P)$

$$2) \text{PBGT}(n) - \text{HO_MARGIN}(n1, n2) > 0$$

where n1: source cell

n2: target cell

The CATCH criteria is defined as follow:

$$\text{RXLEV_NCELL}(0, n) > \text{CATCH}(0, n)$$

where $\text{RXLEV_NCELL}(0, n)$: RXLEV assessed on the BCCH carrier of the cell n

$\text{CATCH}(0, n)$: field strength threshold

This comparison enables handover to be performed towards a cell of a lower layer whom received field strength is considered to be high enough.

D.4 Mobile speeds estimations

As soon as one of the two causes described above is triggered (PBGT, CATCH) a process of computation of the estimation of the mobile speed is performed.

The method of estimation of the field strength variations is based on the computation of the gradient between two averages of field strengths received by the mobile from the target cell.

D.4.1 Estimation of the field strength variations

The first of the two averages of field strength used in the gradient computation is the one computed from measurements received from the target cell which has verified the handover criteria.

The handover cause can be either a PBGT or a CATCH one (see subclause D.3.2 mobile speeds estimation causes).

The second of the two field strength averages used in the gradient computation is the latest one for which the gaps between all the previous averages and the straight line passing-by the two averages defined above is lower than **E_{max}** (**E < E_{max}**).

E_{max} is one of the parameters of the handover algorithm.

The gradient is then computed as follow:

$$1) \text{GRAD} = ((\text{RXLEV_NCELL}(n, N_0) - \text{RXLEV_NCELL}(n, N_0 - m)) / m)$$

where:

- n is the respective adjacent cell "n"
- N_0 is the index of reference of the average for which the handover criteria has been verified
- m is the last average for which $E < E_{\text{max}}$
- $\text{RXLEV_NCELL}(0, n)$ is the RXLEV assessed on the BCCH carrier of the cell n

In order to ensure an efficiency estimation of the mobile speeds a minimum number of averages (N_{amin}) are necessary to trigger the computation of the gradient.

To avoid high computed time and high memory size a maximum number of averages (N_{amax}) has to be kept.

The number of averages to take into account shall verified the following condition:

$$2) N_{\text{amin}} < N < N_{\text{amax}}$$

where:

- N_{Amin} is the minimum number of averages necessary to compute the gradient;
- N_{Amax} is the maximum number of averages necessary to compute the gradient.

If the number of averages is not high enough ($N < N_{Amin}$) a default handover algorithm is used.

The handover towards an upper layer is performed only if the above conditions are verified and if the field strength received from the target cell verified the following condition:

3) $RXLEV > U_RXLEV_NCELL(0,n)$

where:

- $-U_RXLEV_NCELL(0,n)$ is the minimum field strength assessed from the BCCH carrier of the upper layer target cell to performed a handover towards it.

D.5 BSS decision algorithm

The BSS decision algorithm is the classical one as described in the appendix A of the recommendation GSM 05.08 [3]. Nevertheless in the case of an emergency handover, cells of the directly upper layer has priority. If no cell of the directly upper layer is available, cells of the same layer are ordering depending of the PBGT(n_2) - HO_MARGIN(n_1, n_2) values.

D.6 O&M parameters

CELL_TYPE: Hierarchy level of serving cell

Range 0-7
 Step size 1
 Coding 0: microcell
 1: small cell
 2: large cell
 3-7: for future use

NCELL_TYPE(n): Hierarchy level of n-th neighbour cell

n 1-32
 Range 0-7
 Step size 1
 Coding 0: microcell
 1: small cell
 2: large cell
 3-7: for future use

EN_MS_SPEED: Enable/Disable classification of MS regarding SPEED

Coding 0: disable feature
 1: enable feature

N_{Amax}: Maximum number of averages necessary to compute the gradient.

Range 0 - 63 (SACCH)

Step size 1

N_{Amin}: Minimum number of averages necessary to compute the gradient.

Range 0 - 63 (SACCH)

Step size 1

E_{max}: Maximum gap allowed between a computed average and the straight line considered.

Range 0 - 15 (dB)

Step size 1

GRAD: Gradient threshold. It depends of the mobile speed threshold. Middlelayers have two
 Grad thresholds (Gradmin & Gradmax), the upperlayer and the lowerlayer has one threshold (Grad).

Range 0 - 255

Step size 1

CATCH(n): Minimum field strength threshold. This is the minimum field strength the mobile has to
 receive from a cell of the directly lower layer to perform a handover.

Range 0 - 63 (dB)

Step size 1

U_{RXLEV_NCELL(0,n)}: Field strength threshold. This is the minimum field strength necessary to receive
 from the upper layer cell to performed a handover towards it.

Range 0 - 63

Step size 1

D.7 Examples

Figure D.2 features a field strength variations, and its associate averages, measured by a mobile moving away from its source base station.

In this particular case the average window size is four measurements length and the number of measurements kept is equal to nineteen (-> $N_{Amax} = 16$).

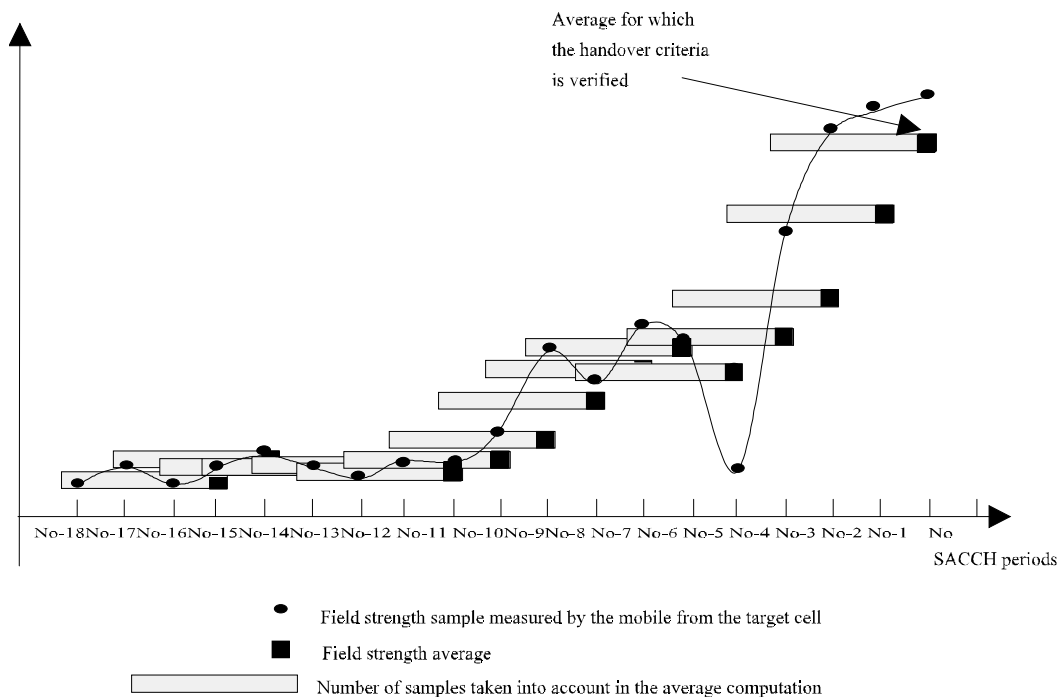

Averages are calculated according to the sliding window technique.

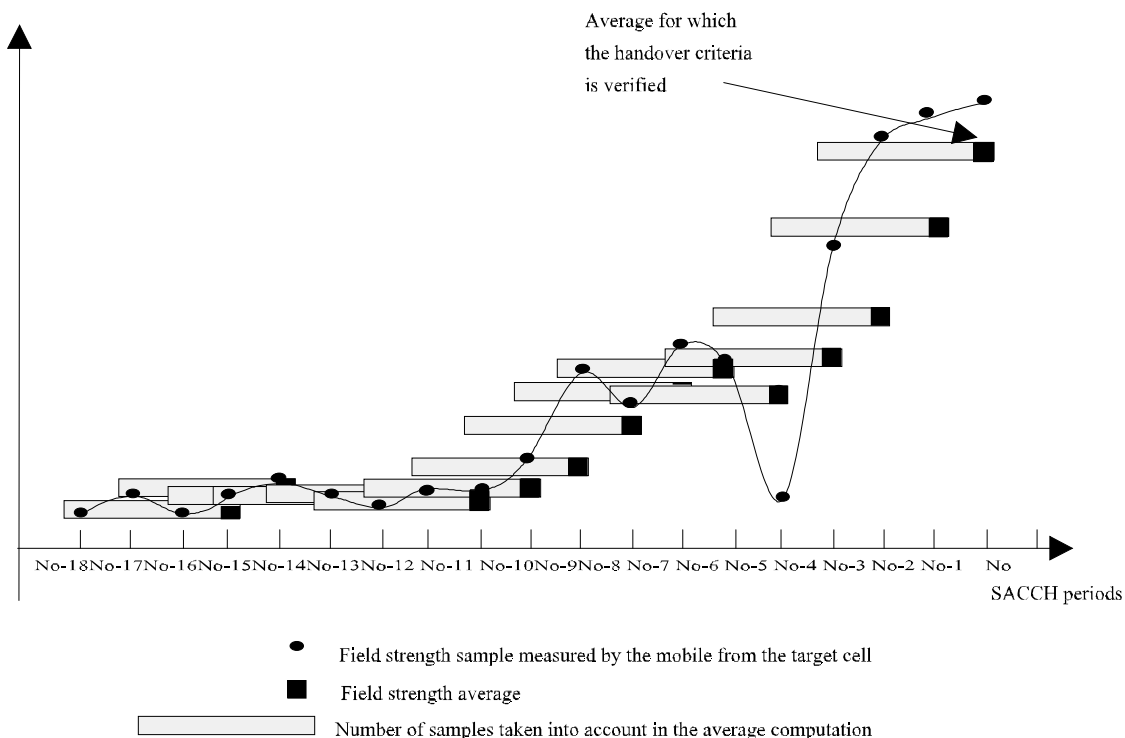

Figure D.2: Field strength samples and averages

In some particular and rare cases the target cell may have a decreasing field strength. In most of the cases that means that it is the "best" cell but that the mobile is moving away from it.

It is even also necessary to take into account the gradient of the field strength in the mobile speeds estimation. For that reason it is necessary to compute the absolute values of gaps and of the gradient.

Figure D.3 features an example of gaps computation.

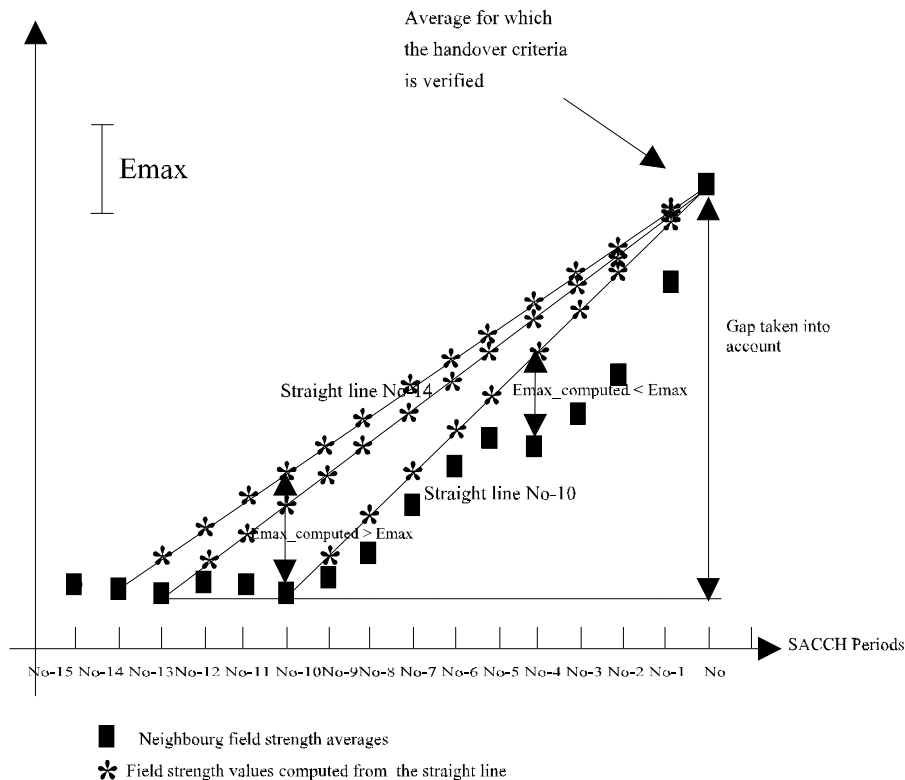

Figure D.3: Gap computation

For each average computed (■), from the latest to the oldest, the algorithm determines the maximum gap with the corresponding field strength computed from the straight line (*).

Considering the average computed at date N_0-10 in the particular case of figure D.3. The maximum gap computed **$E_{max_computed}$** , between the nine previous averages (from N_0-1 to N_0-9) and the straight line N_0-10 , is lower than the maximum gap allowed **E_{max}** .

On the other hand considering the average computed at date N_0-14 . The gap computed between the average on date N_0-10 and the straight line N_0-14 is higher than the maximum gap allowed **E_{max}** .

In this case the last average for which the maximum gap computed is lower than **E_{max}** is the one computed on date **N_0-13** .

In this case the gradient of the field strength is equal to:

$$GRAD = (RXLEV_NCELL(n, N_0) - RXLEV_NCELL(n, N_0-13)) / 13$$

where:

$RXLEV_NCELL(n, N_0)$: RXLEV assessed on the BCCH carrier of the cell n , which has verified the handover criteria (date N_0).

$RXLEV_NCELL(n, N_0-13)$: RXLEV assessed on the BCCH carrier of the cell, computed on date N_0-13 .

In the case of figure D.3, averages are almost constants from date N_0-10 to N_0-15 , it can be the case for example for a mobile stopped at a traffic light. The parameter **E_{max}** avoid to take into account these averages in the estimation of the mobile speeds.

D.8 State diagrams

D.8.1 Case of a three layers hierarchical network

Ideal behaviour: target cells are available

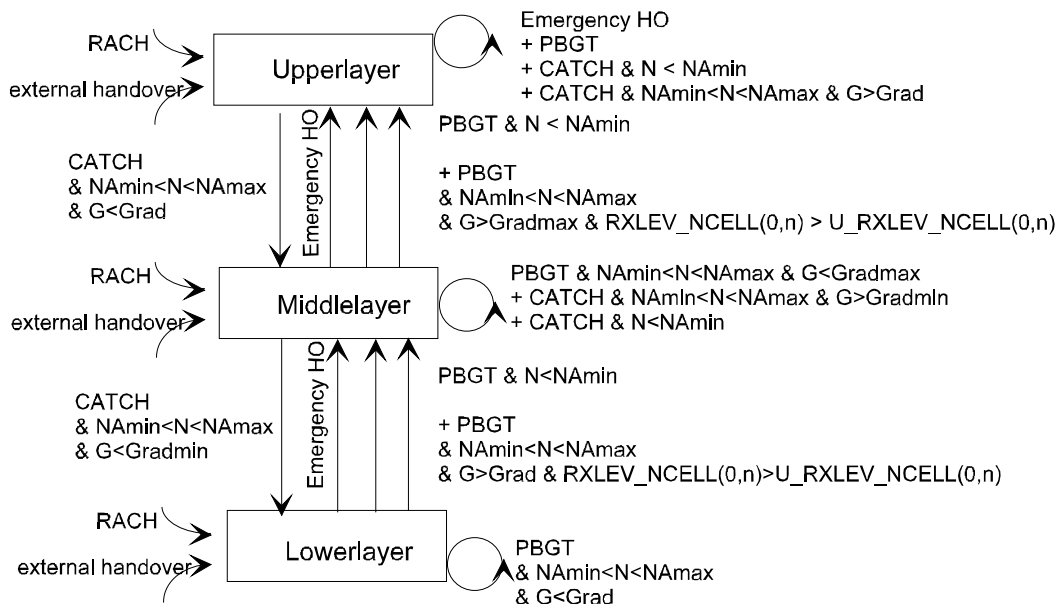

Figure D.4: Handovers in case of availability of the target cell

Non ideal behaviour: target cells may not be available

The handover that may occur to non preferred target cells due to the unavailability of TCH resources are indicated with dotted line arrows in the state diagram.

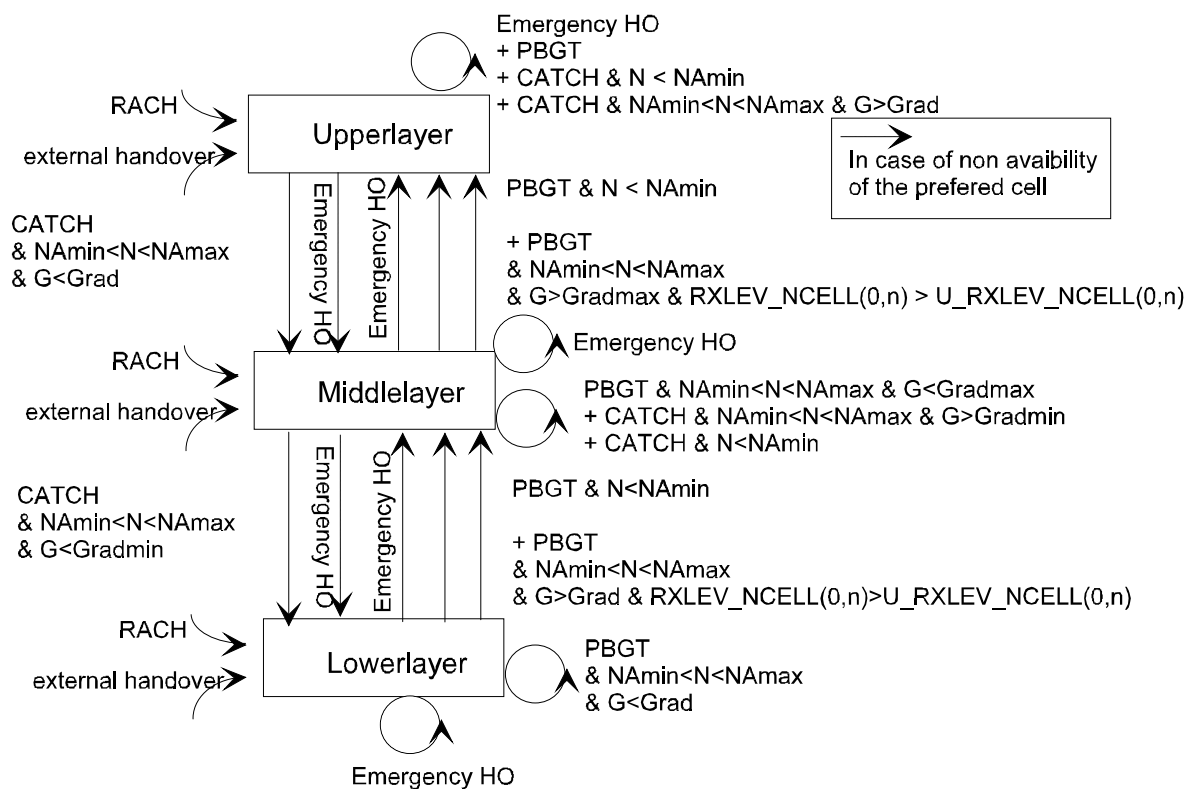

Figure D.5: Handover in case of non availability of the target cell

D.8.2 Case of a two layers hierarchical network

Ideal behaviour: target cells are available

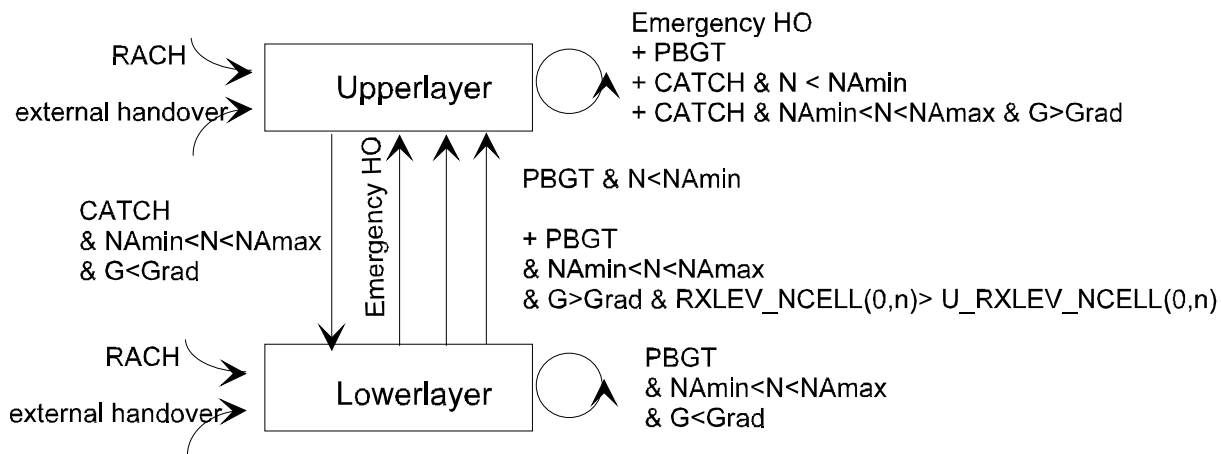
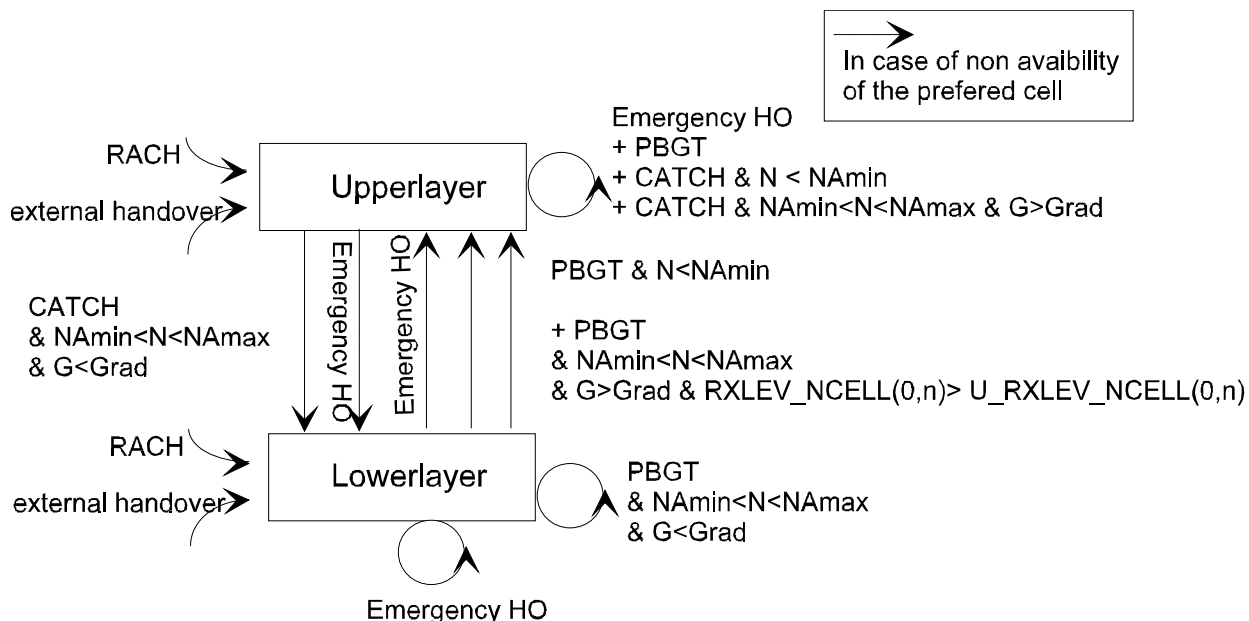

Figure D.6: Handovers in case of availability of the target cell

Non ideal behaviour: target cells may not be available



The handover that may occur to non preferred target cells due to the unavailability of TCH resources are indicated with dotted line arrows in the state diagram.

Figure D.7: Handover in case of non availability of the target cell

Annex E (informative): Simulation Model for Handover Performance Evaluation in Hierarchical Cell Structures

E.1 Introduction

In this annex, the general requirements of a simulation model for handover performance evaluation in hierarchical cell structures are specified.

The following criteria are considered fundamental for the design of the overall simulation model:

- Mobile environment;
- Radio network model;
- Propagation model;
- Motion model;
- Handover algorithms;
- Measurement reporting;
- Performance criteria.

E.2 Mobile Environment

The single mobile environment is taken to allow relatively simple simulations and easier interpretation of the performance results.

In order to simulate the interference that may occur, a detailed frequency allocation pattern and a large number of cells are required. In the single mobile environment, the interference situation is not taken into account. Therefore, handovers due to quality are not simulated. However, this enables the very evaluation of the handover algorithm, and not the evaluation of the frequency pattern.

E.3 Radio Network Model

The radio network model represents the network layout. It should allow the definition of the following parameters:

- Number of layers;
- Number of cells on each layer;
- BTS site pattern;
- BTS separation.

Three network model scenarios are proposed.

E.3.1 Scenario 1: Hot Spot

One cell in the upper layer, one cell in the lower layer.

E.3.2 Scenario 2: Line of Cells

Two cell in the upper layer, 5 cells in the lower layer. Lower layer cell distance: 400 m. Upper layer cell distance: 2 km.

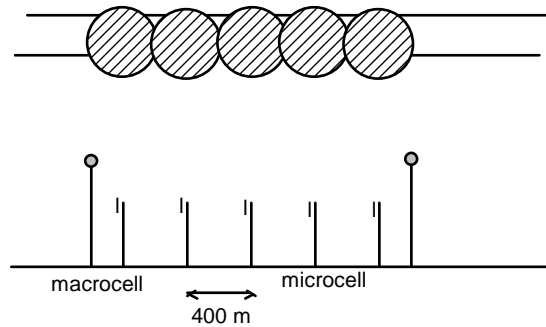

Figure E.1

E.3.3 Scenario 3: Manhattan Coverage

Four cells in the upper layer, 13 cells in the lower layer. Lower layer cell distance between BTS: 400 m. Upper layer cell distance: 2 km. The cells in the lower layer are situated at alternate crossings.

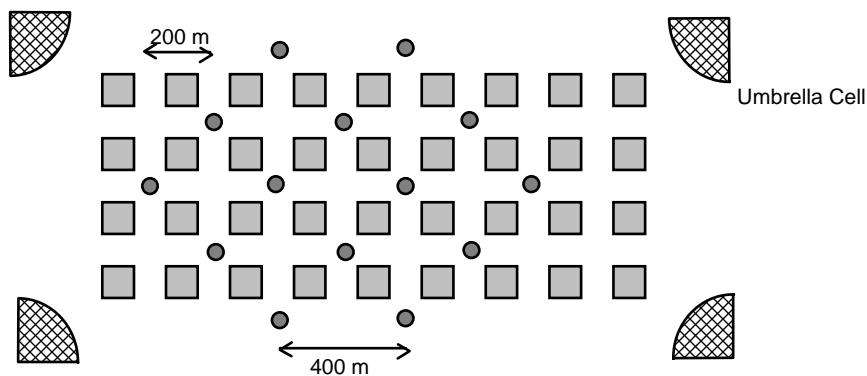

Figure E.2

E.4 Propagation Model

E.4.1 Upper Layer Path Loss

E.4.1.1 Macrocells

For macrocells the GSM 03.30 Hata model is used to simulate this layer.

Table E.1: Validity domain of Hata's model for GSM 900 MHz

Parameter	Validity range
Frequency (f)	150 MHz - 1 000 MHz
Base station height (H _b)	30 - 200 m
MS height (H _m)	1 - 10 m
Distance (d)	1 - 20 km

For DCS 1800 the model is different and not given in the present document.

Hata's model

For urban environment, the formula is given by:

$$L_u = 69.55 + 26.16 \cdot \log(f) - 13.82 \cdot \log(H_b) - a(H_m) + [44.9 - 6.55 \cdot \log(H_b)] \cdot \log(d)$$

the corrective term $a(H_m)$ is zero for MS antenna height of 1.5 m, which is assumed.

For suburban, rural quasi-open and rural open environment there are corrective terms. Since microcellular approach is not assumed in these environments, these terms are not given.

Simulation Profile

A typical profile at 900 MHz for urban environment is given in the table below:

Table E.2

BTS antenna height (m)	30	50	100
MS antenna height (m)	1.5	1.5	1.5
Hata's loss (d in km)	$126.4 + 35.2 \cdot \log(d)$	$123.3 + 33.7 \cdot \log(d)$	$119.2 + 31.8 \cdot \log(d)$

For the simulation a base station antenna height of 30 m is used.

E.4.1.2 Small cells

The propagation model for small cells, with a typical maximum range of 1-3 km, can be derived also from GSM 03.30. Therefore COST 231 Walfish-Ikegami model can be utilized.

Table E.3: Validity domain of COST 231 Walfish Ikegami model

Parameter	Validity range
Frequency (f)	800 MHz - 2 000 MHz
BTS antenna height (H _b)	4 - 50 m
MS antenna height (H _m)	1 - 3 m
Distance (d)	0.02 - 5 km
Height of buildings (H _{roof} , in m)	
Width of road (w, in m)	
Building separation (b, in m)	
Road orientation with respect to the direct path (Phi, in °)	
Urban areas	

COST 231 Walfish Ikegami model

Two profiles are defined: with and without line of sight.

Line of sight formula

The COST 231 Walfish-Ikegami formula for urban environment with line-of-sight (Street Canyon) is

$$L_b = 42.6 + 26 \cdot \log(d) + 20 \cdot \log(f)$$

for $d \geq 0.020$ km

Note that this equation is not valid in the case of line of sight in a microcell because of the canyon effect in a microcell.

Non line-of-site formula

$$L_b = L_o + L_{rts} + L_{msd}$$

with L_o free-space loss

$$L_o = 32.4 + 20 \cdot \log(d) + 20 \cdot \log(f)$$

with L_{rst} (roof-top-to-street diffraction and scatter loss)

$$L_{rst} = -16.9 - 10 \cdot \log(w) + 10 \cdot \log(f) + 20 \cdot \log(H_r - H_m) + L_{cri}$$

with

$$L_{cri} = -10 + 0.354 \cdot \Phi \quad \text{for } 0^\circ \leq \Phi < 35^\circ$$

$$L_{cri} = 2.5 + 0.075 \cdot (\Phi - 35) \quad \text{for } 35^\circ \leq \Phi < 55^\circ$$

$$L_{cri} = 4.0 - 0.114 \cdot (\Phi - 55) \quad \text{for } 55^\circ \leq \Phi < 90^\circ$$

with L_{msd} a parameter that will be given for metropolitan centres.

Simulation profile

A typical profile at 900 MHz for urban environment that can be used in the simulations is given in the table below:

Width of the road, $w = 20$ m

Height of building roof tops, $H_{roof} = 15$ m

Height of BTS antenna, $H_b = 17$ m

Road orientation to direct radio path, $\phi = 90^\circ$

Building separation, $b = 40$ m

$$Loss(dB) = 132.8 + 38 \cdot \log(d)$$

where d is in km.

NOTE: It is not possible to use this model in the case of antenna height just below roof top. In this environment an additional term is required, which is not given in order not to complexify the simulations.

E.4.2 Lower Layer Path Loss

The lower layer uses an outdoor propagation model, called dual slope model. It is based on a model used in "Path Loss and Fading in Microcells", COST231 TD 65, Darmstadt, 12th September 1990.

The values of the different parameters were determined by field measurements considering a street width of 18,5 metres.

E.4.2.1 Line-of-sight Case

In the line-of-sight case, the path loss L is given by:

$$L(d) = 27 + 10 \log \left[\left(d^{n_1} \right)^p + \left(d^{n_1} \left(d / d_L \right)^{n_2 - n_1} \right)^p \right]^{1/p}$$

with the parameters:

d : distance transmitter-receiver *in metres*

d_L : distance between transmitting antenna and breakpoint (m) 500 m

n_1 : slope factor of path loss before breakpoint 2.6

n_2 : slope factor of path loss after breakpoint 4.0

p : shape factor 4

E.4.2.2 Non Line-of-sight Case

In the non line-of-sight case, the supplementary path loss introduced is:

$$L'(y) = 10 \log \left[\left(\left(\frac{y}{y_{E1}} + 1 \right)^{n_{E1}} \right)^p + \left(\left(\frac{y^{E2}}{y^{E1}} + 1 \right)^{n_{E1}} \times \left(\frac{y + y_{E1}}{y_{E1} + y_{E2}} \right)^{n_{E2}} \right)^p \right]^{1/p}$$

with the parameters:

- y: distance in non-line-of-sight from the BTS *in meters*
- y_{E1}: distance from corner to virtual position of transmitter (m) 2.6
- y_{E2}: breakpoint distance 65.3 m
- n_{E1}: slope factor of path loss before breakpoint 2.34
- n_{E2}: slope factor of path loss after breakpoint 2.84
- p: shape factor 4

For instance, with the following configuration:

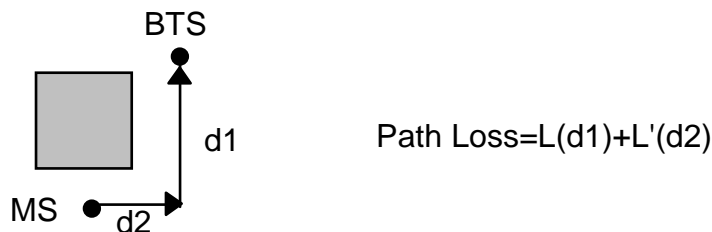

Figure E.3

E.4.2.3 Shape of the level with the proposed path loss model

We considered the following scenario:

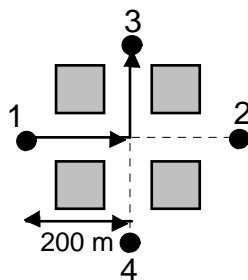

Figure E.4

When the MS goes from BTS 1 to BTS 3, the path losses of the different BTSs have the following shape:

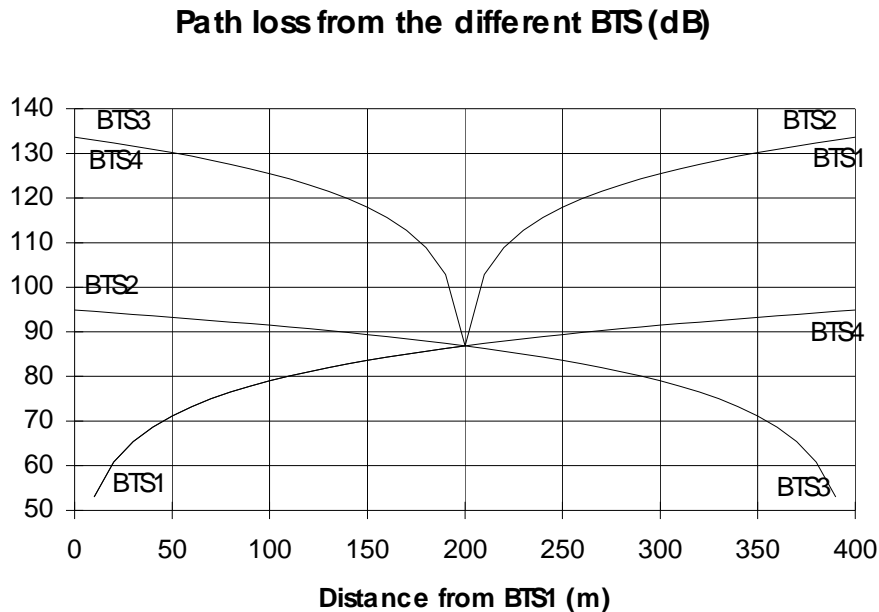

Figure E.5

E.4.3 Fading

Fast (Rayleigh) fading is neglected as the values considered are averaged over at least 0.5 ms.

Slow fading (shadowing) is modelled by a Gaussian distributed random variable F to the path loss level value. The model is characterized by two parameters:

- the standard deviation of the Gaussian distribution, Macrocell: 6 dB, Microcell: 4 dB,
- the correlation length, $d_{cor}=10$ metres.

The correlation function between two positions of the MS x_1 and x_2 can be written:

$$\text{corr}(F(x_1) F(x_2)) = \exp\left(-\frac{\lambda |x_1 - x_2|}{d_{corr}} \right)$$

where λ is a constant. Note that for $\lambda = \ln 2$, the correlation function equals 0.5 at the correlation distance.

E.5 Motion Model

The MS can either go straight or turn at the corner of a street.

Four constant speeds shall be considered: 3, 36, 54 and 72 km/h. In the turning around the corner case, only the speeds 3 km/h and 36 km/h shall be considered.

The two motion models should be simulated for the three radio network scenarios proposed.

E.6 Handover Algorithms

As per annex A-D.

The late handover decision and the delay between handover decision and execution shall be considered, which could lead to dropped calls.

E.7 Measurement Reporting

This effect, especially for corner effects, of the time delay between receiving and no longer receiving a neighbour cell, and reporting to the BTS plus the BTS handling time has to be accounted for.

E.8 Performance Criteria

The following performance criteria will be taken:

- Percentage of time a call is handled on the different layers;
- Distribution of the position where the handover takes place;
- Number of handovers;
- Number of dropped calls.

E.9 Open Issues

- Location of call set up and termination.
- ###How to simulate the measurement reporting?

It was proposed to simulate the delay in the measurement reporting either by a constant or by a random variable between 0 and a value to be determined.

Annex F (informative): Change history

Change history							
Date	TSG #	TSG Doc.	CR	Rev	Subject/Comment	Old	New
2001-04	4				Version for Release 4		4.0.0
2002-06	10				Version for Release 5	4.0.0	5.0.0
2005-01	23				Version for Release 6	5.0.0	6.0.0
2007-08	35				Version for Release 7	6.0.0	7.0.0
2008-12	40				Version for Release 8	7.0.0	8.0.0
2009-12	44				Version for Release 9	8.0.0	9.0.0
2011-03	49				Version for Release 10	9.0.0	10.0.0
2012-09	55				Version for Release 11	10.0.0	11.0.0
2014-09	63				Version for Release 12 (frozen at SP-65)	11.0.0	12.0.0
2015-12	68				Version for Release 13 (frozen at SP-70)	12.0.0	13.0.0

Change history							
Date	Meeting	TDoc	CR	Rev	Cat	Subject/Comment	New version
2017-03	75					Version for Release 14 (frozen at TSG-75)	14.0.0

History

Document history		
V14.0.0	April 2017	Publication