

# ETSI TS 148 008 V4.8.0 (2002-07)

---

*Technical Specification*

**Digital cellular telecommunications system (Phase 2+);  
Mobile Switching Centre - Base Station system  
(MSC-BSS) Interface Layer 3 Specification  
(3GPP TS 48.008 version 4.8.0 Release 4)**

---



---

Reference

RTS/TSGG-0248008v480

---

Keywords

GSM

**ETSI**

650 Route des Lucioles  
F-06921 Sophia Antipolis Cedex - FRANCE

Tel.: +33 4 92 94 42 00 Fax: +33 4 93 65 47 16

Siret N° 348 623 562 00017 - NAF 742 C  
Association à but non lucratif enregistrée à la  
Sous-Préfecture de Grasse (06) N° 7803/88

---

**Important notice**

Individual copies of the present document can be downloaded from:

<http://www.etsi.org>

The present document may be made available in more than one electronic version or in print. In any case of existing or perceived difference in contents between such versions, the reference version is the Portable Document Format (PDF). In case of dispute, the reference shall be the printing on ETSI printers of the PDF version kept on a specific network drive within ETSI Secretariat.

Users of the present document should be aware that the document may be subject to revision or change of status. Information on the current status of this and other ETSI documents is available at

<http://portal.etsi.org/tb/status/status.asp>

If you find errors in the present document, send your comment to:

[editor@etsi.fr](mailto:editor@etsi.fr)

---

**Copyright Notification**

No part may be reproduced except as authorized by written permission.  
The copyright and the foregoing restriction extend to reproduction in all media.

© European Telecommunications Standards Institute 2002.  
All rights reserved.

**DECT**<sup>TM</sup>, **PLUGTESTS**<sup>TM</sup> and **UMTS**<sup>TM</sup> are Trade Marks of ETSI registered for the benefit of its Members.  
**TIPHON**<sup>TM</sup> and the **TIPHON logo** are Trade Marks currently being registered by ETSI for the benefit of its Members.  
**3GPP**<sup>TM</sup> is a Trade Mark of ETSI registered for the benefit of its Members and of the 3GPP Organizational Partners.

---

## Intellectual Property Rights

IPRs essential or potentially essential to the present document may have been declared to ETSI. The information pertaining to these essential IPRs, if any, is publicly available for **ETSI members and non-members**, and can be found in ETSI SR 000 314: "*Intellectual Property Rights (IPRs); Essential, or potentially Essential, IPRs notified to ETSI in respect of ETSI standards*", which is available from the ETSI Secretariat. Latest updates are available on the ETSI Web server (<http://webapp.etsi.org/IPR/home.asp>).

Pursuant to the ETSI IPR Policy, no investigation, including IPR searches, has been carried out by ETSI. No guarantee can be given as to the existence of other IPRs not referenced in ETSI SR 000 314 (or the updates on the ETSI Web server) which are, or may be, or may become, essential to the present document.

---

## Foreword

This Technical Specification (TS) has been produced by ETSI 3rd Generation Partnership Project (3GPP).

The present document may refer to technical specifications or reports using their 3GPP identities, UMTS identities or GSM identities. These should be interpreted as being references to the corresponding ETSI deliverables.

The cross reference between GSM, UMTS, 3GPP and ETSI identities can be found under [www.etsi.org/key](http://www.etsi.org/key) .

# Contents

|   |    |
|---|----|
| Intellectual Property Rights .....  | 2  |
| Foreword.....   | 2  |
| Foreword.....   | 8  |
| 1 Scope .....   | 9  |
| 1.1 Normative references .....  | 9  |
| 1.2 Abbreviations .....   | 11 |
| 2 Application to interface structures .....   | 11 |
| 2.1 The BSS Operation and Maintenance Application Part .....                        | 11 |
| 2.2 The Direct Transfer Application Part .....                                      | 11 |
| 2.3 The BSS Management Application Part.....  | 11 |
| 2.4 Handling of abnormal events related to the BSSAP Header .....                   | 12 |
| 3 The BSS Management Application Part .....   | 12 |
| 3.1 BSSMAP Procedures .....   | 12 |
| 3.1.1 Assignment .....  | 13 |
| 3.1.1.1 Successful Operation.....   | 13 |
| 3.1.1.2 Assignment Failure .....  | 15 |
| 3.1.1.3 Abnormal Conditions .....   | 16 |
| 3.1.2 Blocking and Unblocking .....   | 16 |
| 3.1.2.1 Successful Operation.....   | 16 |
| 3.1.2.2 Abnormal Conditions .....   | 17 |
| 3.1.2.2.1 Applying to the Single Circuit Block Procedure .....                      | 18 |
| 3.1.2.2.2 Applying to the Circuit Group Block Procedure .....                       | 18 |
| 3.1.3 Resource Indication .....   | 19 |
| 3.1.3.1 Successful Operation.....   | 19 |
| 3.1.4 Reset .....   | 20 |
| 3.1.4.1 Global Reset Procedure.....   | 20 |
| 3.1.4.1.1 Reset at the BSS .....  | 20 |
| 3.1.4.1.2 Reset at the MSC .....  | 21 |
| 3.1.4.1.3 Abnormal Conditions .....   | 21 |
| 3.1.4.2 Reset Circuit.....  | 21 |
| 3.1.4.2.1 Reset Circuit at the BSS .....  | 21 |
| 3.1.4.2.2 Reset Circuit at the MSC .....  | 22 |
| 3.1.4.2.3 Abnormal conditions .....   | 22 |
| 3.1.5 External Handover .....   | 22 |
| 3.1.5.1 Handover Required Indication .....  | 23 |
| 3.1.5.1.1 Generation of the HANDOVER REQUIRED message .....                         | 23 |
| 3.1.5.2 Handover Resource allocation .....  | 25 |
| 3.1.5.2.1 Operation of the procedure .....  | 25 |
| 3.1.5.2.2 Handover Resource Allocation Failure .....                                | 27 |
| 3.1.5.2.3 Abnormal conditions .....   | 27 |
| 3.1.5.3 Handover execution .....  | 27 |
| 3.1.5.3.1 Operation of the procedure .....  | 28 |
| 3.1.5.3.2 Handover Failure .....  | 29 |
| 3.1.5.3.3 Abnormal Conditions .....   | 29 |
| 3.1.5a Handover from GSM to another System .....                                    | 30 |
| 3.1.5a.1 Generation of the HANDOVER REQUIRED message for intersystem handover ..... | 30 |
| 3.1.5a.2 Inter-System Handover Resource Allocation Failure .....                    | 31 |
| 3.1.5a.3 Intersystem handover Execution.....  | 31 |
| 3.1.5a.4 Inter System Handover Failure.....   | 31 |
| 3.1.5a.5 Abnormal Conditions .....  | 32 |
| 3.1.6 Internal Intra-Cell Handover Procedure.....                                   | 32 |
| 3.1.7 Internal Inter-Cell Handover Procedure.....                                   | 32 |
| 3.1.8 Handover Candidate Enquiry.....   | 33 |
| 3.1.8.1 Successful Operation.....   | 33 |

|            |  |    |
|------------|--|----|
| 3.1.8.2    | Abnormal conditions .....  | 34 |
| 3.1.9      | Release of Radio Resource And Terrestrial Resource .....                                       | 34 |
| 3.1.9.1    | Release Due To Transaction Completion.....   | 34 |
| 3.1.9.2    | Release due to BSS generated reason .....  | 34 |
| 3.1.9.3    | Release due to successful handover .....   | 34 |
| 3.1.9.4    | Release due to uplink release .....  | 35 |
| 3.1.10     | Paging .....   | 35 |
| 3.1.11     | Trace Invocation .....   | 35 |
| 3.1.12     | Flow Control .....   | 35 |
| 3.1.12.1   | Philosophy.....  | 36 |
| 3.1.12.2   | Processor Overload at the MSC .....  | 36 |
| 3.1.12.3   | Processor/CCCH overload at the BSS .....   | 36 |
| 3.1.12.4   | Message throughput congestion .....  | 36 |
| 3.1.13     | Classmark Handling Procedures .....  | 36 |
| 3.1.13.1   | Classmark request procedure .....  | 36 |
| 3.1.13.2   | Classmark updating procedure .....   | 37 |
| 3.1.14     | Cipher Mode Control.....   | 37 |
| 3.1.14.1   | Successful Operation.....  | 37 |
| 3.1.14.2   | Abnormal Conditions .....  | 37 |
| 3.1.15     | General SCCP Abnormal Conditions .....   | 38 |
| 3.1.16     | Initial MS message.....  | 38 |
| 3.1.17     | Queuing Indication .....   | 39 |
| 3.1.17.1   | Operation of the procedure in case of assignment procedure.....                                | 39 |
| 3.1.17.2   | Operation of the procedure in case of hand-over resource allocation procedure .....            | 39 |
| 3.1.18     | Data Link Control SAPI not Equal to "0" .....  | 39 |
| 3.1.18.1   | Data link set up across the radio interface.....   | 39 |
| 3.1.18.1.1 | MS to MSC direction.....   | 39 |
| 3.1.18.1.2 | MSC to MS Direction.....   | 39 |
| 3.1.18.2   | Choice of the signalling link .....  | 40 |
| 3.1.19     | BSSMAP Error Handling .....  | 40 |
| 3.1.19.1   | Definitions of Types of Information Elements.....  | 40 |
| 3.1.19.2   | Erroneous Events .....   | 41 |
| 3.1.19.3   | Non-erroneous Events.....  | 41 |
| 3.1.19.4   | Other Events.....  | 42 |
| 3.1.19.5   | Appropriate Error Message and Cause Value .....  | 42 |
| 3.1.19.6   | Unequipped Circuit Identification Code .....   | 43 |
| 3.1.19.7   | Field Elements.....  | 44 |
| 3.1.20     | Load Indication Procedure.....   | 44 |
| 3.1.20.1   | Operation of the procedure.....  | 45 |
| 3.1.21     | Voice group call service and voice broadcast service call set-up and resource assignment ..... | 45 |
| 3.1.21.1   | Successful operation.....  | 45 |
| 3.1.21.2   | VGCS/VBS call set-up abnormal cases .....  | 45 |
| 3.1.21.3   | VGCS/VBS call set-up failure .....   | 45 |
| 3.1.22     | Voice group call service and voice broadcast service Assignment procedure.....                 | 46 |
| 3.1.22.1   | Successful operation.....  | 46 |
| 3.1.22.2   | VGCS/VBS Assignment abnormal cases .....   | 46 |
| 3.1.22.3   | VGCS/VBS Assignment failure.....   | 46 |
| 3.1.23     | Void .....   | 47 |
| 3.1.24     | Voice group call uplink control procedure .....  | 47 |
| 3.1.24.1   | Uplink allocation procedure .....  | 47 |
| 3.1.24.1.1 | Successful uplink allocation operation .....   | 47 |
| 3.1.24.1.2 | Unsuccessful uplink allocation operation .....   | 47 |
| 3.1.24.2   | Uplink release procedure.....  | 47 |
| 3.1.24.3   | Uplink seize procedure.....  | 48 |
| 3.1.25     | PDSS1 flow control .....   | 48 |
| 3.1.26     | Circuit re-selection procedure.....  | 48 |
| 3.1.27     | LSA handling.....  | 48 |
| 3.1.28     | Location Acquisition.....  | 49 |
| 3.1.28.1   | Void.....  | 49 |
| 3.1.28.2   | Location request.....  | 49 |
| 3.1.28.2.1 | Successful Operation.....  | 49 |
| 3.1.28.2.2 | Unsuccessful Operation .....   | 50 |

|            |  |    |
|------------|--|----|
| 3.1.28.2.3 | Abnormal cases .....                               | 50 |
| 3.1.28.2.4 | Overload .....                                     | 50 |
| 3.1.29     | Connectionless Information Transfer procedure..... | 50 |
| 3.1.29.1   | Unsuccessful Operation.....                        | 50 |
| 3.1.29.2   | Abnormal cases .....                               | 50 |
| 3.1.29.3   | Segmentation .....                                 | 50 |
| 3.1.30     | Common ID .....                                    | 51 |
| 3.2        | Message Formats and Coding .....                   | 51 |
| 3.2.1      | Message Contents .....                             | 53 |
| 3.2.1.1    | ASSIGNMENT REQUEST .....                           | 53 |
| 3.2.1.2    | ASSIGNMENT COMPLETE .....                          | 54 |
| 3.2.1.3    | ASSIGNMENT FAILURE .....                           | 54 |
| 3.2.1.4    | BLOCK .....  | 55 |
| 3.2.1.5    | BLOCKING ACKNOWLEDGE .....                         | 55 |
| 3.2.1.6    | UNBLOCK .....                                      | 55 |
| 3.2.1.7    | UNBLOCKING ACKNOWLEDGE .....                       | 55 |
| 3.2.1.8    | HANDOVER REQUEST .....                             | 56 |
| 3.2.1.9    | HANDOVER REQUIRED .....                            | 58 |
| 3.2.1.10   | HANDOVER REQUEST ACKNOWLEDGE.....                  | 59 |
| 3.2.1.11   | HANDOVER COMMAND .....                             | 59 |
| 3.2.1.12   | HANDOVER COMPLETE .....                            | 59 |
| 3.2.1.13   | HANDOVER SUCCEEDED .....                           | 60 |
| 3.2.1.14   | HANDOVER CANDIDATE ENQUIRE.....                    | 60 |
| 3.2.1.15   | HANDOVER CANDIDATE RESPONSE .....                  | 60 |
| 3.2.1.16   | HANDOVER FAILURE .....                             | 60 |
| 3.2.1.17   | RESOURCE REQUEST .....                             | 61 |
| 3.2.1.18   | RESOURCE INDICATION .....                          | 61 |
| 3.2.1.19   | PAGING .....                                       | 62 |
| 3.2.1.20   | CLEAR REQUEST.....                                 | 62 |
| 3.2.1.21   | CLEAR COMMAND .....                                | 62 |
| 3.2.1.22   | CLEAR COMPLETE.....                                | 63 |
| 3.2.1.23   | RESET .....  | 63 |
| 3.2.1.24   | RESET ACKNOWLEDGE .....                            | 63 |
| 3.2.1.25   | HANDOVER PERFORMED .....                           | 64 |
| 3.2.1.26   | OVERLOAD.....                                      | 64 |
| 3.2.1.27   | MSC INVOKE TRACE.....                              | 65 |
| 3.2.1.28   | BSS INVOKE TRACE .....                             | 65 |
| 3.2.1.29   | CLASSMARK UPDATE.....                              | 65 |
| 3.2.1.30   | CIPHER MODE COMMAND.....                           | 65 |
| 3.2.1.31   | CIPHER MODE COMPLETE.....                          | 66 |
| 3.2.1.32   | COMPLETE LAYER 3 INFORMATION.....                  | 66 |
| 3.2.1.33   | QUEUEING INDICATION.....                           | 66 |
| 3.2.1.34   | SAPI "n" REJECT.....                               | 66 |
| 3.2.1.35   | Void.....  | 67 |
| 3.2.1.36   | Void.....  | 67 |
| 3.2.1.37   | HANDOVER REQUIRED REJECT .....                     | 67 |
| 3.2.1.38   | RESET CIRCUIT .....                                | 67 |
| 3.2.1.39   | RESET CIRCUIT ACKNOWLEDGE.....                     | 67 |
| 3.2.1.40   | HANDOVER DETECT .....                              | 67 |
| 3.2.1.41   | CIRCUIT GROUP BLOCK.....                           | 68 |
| 3.2.1.42   | CIRCUIT GROUP BLOCKING ACKNOWLEDGE.....            | 68 |
| 3.2.1.43   | CIRCUIT GROUP UNBLOCK .....                        | 68 |
| 3.2.1.44   | CIRCUIT GROUP UNBLOCKING ACKNOWLEDGE .....         | 68 |
| 3.2.1.45   | CONFUSION.....                                     | 69 |
| 3.2.1.46   | CLASSMARK REQUEST .....                            | 69 |
| 3.2.1.47   | UNEQUIPPED CIRCUIT.....                            | 69 |
| 3.2.1.48   | CIPHER MODE REJECT.....                            | 69 |
| 3.2.1.49   | LOAD INDICATION .....                              | 70 |
| 3.2.1.50   | VGCS/VBS SETUP .....                               | 70 |
| 3.2.1.51   | VGCS/VBS SETUP ACK.....                            | 70 |
| 3.2.1.52   | VGCS/VBS SETUP REFUSE .....                        | 70 |
| 3.2.1.53   | VGCS/VBS ASSIGNMENT REQUEST.....                   | 71 |

|          |                                   |     |
|----------|-----------------------------------|-----|
| 3.2.1.54 | VGCS/VBS ASSIGNMENT RESULT.....   | 71  |
| 3.2.1.55 | VGCS/VBS ASSIGNMENT FAILURE.....  | 71  |
| 3.2.1.56 | VGCS/VBS QUEUING INDICATION.....  | 72  |
| 3.2.1.57 | UPLINK REQUEST.....               | 72  |
| 3.2.1.58 | UPLINK REQUEST ACKNOWLEDGE.....   | 72  |
| 3.2.1.59 | UPLINK REQUEST CONFIRMATION.....  | 72  |
| 3.2.1.60 | UPLINK RELEASE INDICATION.....    | 73  |
| 3.2.1.61 | UPLINK REJECT COMMAND.....        | 73  |
| 3.2.1.62 | UPLINK RELEASE COMMAND.....       | 73  |
| 3.2.1.63 | UPLINK SEIZED COMMAND.....        | 73  |
| 3.2.1.64 | SUSPEND.....                      | 73  |
| 3.2.1.65 | RESUME.....                       | 74  |
| 3.2.1.66 | CHANGE CIRCUIT.....               | 74  |
| 3.2.1.67 | CHANGE CIRCUIT ACKNOWLEDGE.....   | 74  |
| 3.2.1.68 | Common ID.....                    | 74  |
| 3.2.1.69 | LSA INFORMATION.....              | 74  |
| 3.2.1.70 | Void.....                         | 75  |
| 3.2.1.71 | PERFORM LOCATION REQUEST.....     | 75  |
| 3.2.1.72 | PERFORM LOCATION RESPONSE.....    | 75  |
| 3.2.1.73 | PERFORM LOCATION ABORT.....       | 75  |
| 3.2.1.74 | CONNECTIONLESS INFORMATION.....   | 75  |
| 3.2.2    | Signalling element coding.....    | 76  |
| 3.2.2.1  | Message Type.....                 | 79  |
| 3.2.2.2  | Circuit Identity Code.....        | 80  |
| 3.2.2.3  | Connection Release Requested..... | 81  |
| 3.2.2.4  | Resource Available.....           | 81  |
| 3.2.2.5  | Cause.....                        | 82  |
| 3.2.2.6  | IMSI.....                         | 84  |
| 3.2.2.7  | TMSI.....                         | 84  |
| 3.2.2.8  | Number Of MSs.....                | 84  |
| 3.2.2.9  | Layer 3 Header Information.....   | 85  |
| 3.2.2.10 | Encryption Information.....       | 85  |
| 3.2.2.11 | Channel Type.....                 | 86  |
| 3.2.2.12 | Periodicity.....                  | 92  |
| 3.2.2.13 | Extended Resource Indicator.....  | 92  |
| 3.2.2.14 | Total Resource Accessible.....    | 93  |
| 3.2.2.15 | LSA Identifier.....               | 93  |
| 3.2.2.16 | LSA Identifier List.....          | 93  |
| 3.2.2.17 | Cell Identifier.....              | 94  |
| 3.2.2.18 | Priority.....                     | 96  |
| 3.2.2.19 | Classmark Information Type 2..... | 97  |
| 3.2.2.20 | Classmark Information Type 3..... | 97  |
| 3.2.2.21 | Interference Band To Be Used..... | 98  |
| 3.2.2.22 | RR Cause.....                     | 98  |
| 3.2.2.23 | LSA Information.....              | 98  |
| 3.2.2.24 | Layer 3 Information.....          | 99  |
| 3.2.2.25 | DLCI.....                         | 99  |
| 3.2.2.26 | Downlink DTX Flag.....            | 99  |
| 3.2.2.27 | Cell Identifier List.....         | 100 |
| 3.2.2.28 | Response Request.....             | 103 |
| 3.2.2.29 | Resource Indication Method.....   | 103 |
| 3.2.2.30 | Classmark Information Type 1..... | 103 |
| 3.2.2.31 | Circuit Identity Code List.....   | 104 |
| 3.2.2.32 | Diagnostics.....                  | 105 |
| 3.2.2.33 | Chosen Channel.....               | 105 |
| 3.2.2.34 | Cipher Response Mode.....         | 106 |
| 3.2.2.35 | Layer 3 Message Contents.....     | 107 |
| 3.2.2.36 | Channel Needed.....               | 107 |
| 3.2.2.37 | Trace Type.....                   | 107 |
| 3.2.2.38 | TriggerID.....                    | 107 |
| 3.2.2.39 | Trace Reference.....              | 108 |
| 3.2.2.40 | TransactionID.....                | 108 |

|  |  |            |
|--|--|------------|
| 3.2.2.41   | Mobile Identity.....   | 108        |
| 3.2.2.42   | OMCID .....  | 108        |
| 3.2.2.43   | Forward Indicator.....   | 108        |
| 3.2.2.44   | Chosen Encryption Algorithm .....                                | 109        |
| 3.2.2.45   | Circuit Pool .....   | 109        |
| 3.2.2.46   | Circuit Pool List .....  | 112        |
| 3.2.2.47   | Time Indication .....  | 112        |
| 3.2.2.48   | Resource Situation .....   | 113        |
| 3.2.2.49   | Current Channel Type 1 .....                                     | 114        |
| 3.2.2.50   | Queuing Indicator .....  | 115        |
| 3.2.2.51   | Speech Version .....   | 115        |
| 3.2.2.52   | Assignment Requirement .....                                     | 116        |
| 3.2.2.53   | Void.....  | 116        |
| 3.2.2.54   | Talker Flag .....  | 116        |
| 3.2.2.55   | Group Call Reference.....  | 116        |
| 3.2.2.56   | eMLPP Priority .....   | 116        |
| 3.2.2.57   | Configuration Evolution Indication .....                         | 117        |
| 3.2.2.58   | Old BSS to New BSS information .....                             | 117        |
| 3.2.2.59   | Void.....  | 118        |
| 3.2.2.60   | LCS QoS .....  | 118        |
| 3.2.2.61   | LSA Access Control Suppression .....                             | 118        |
| 3.2.2.62   | LCS Priority .....   | 118        |
| 3.2.2.63   | Location Type .....  | 119        |
| 3.2.2.64   | Location Estimate .....  | 119        |
| 3.2.2.65   | Positioning Data .....   | 119        |
| 3.2.2.66   | LCS Cause.....   | 119        |
| 3.2.2.67   | LCS Client Type .....  | 120        |
| 3.2.2.68   | APDU.....  | 120        |
| 3.2.2.69   | Network Element Identity .....                                   | 120        |
| 3.2.2.70   | GPS Assistance Data.....   | 120        |
| 3.2.2.71   | Deciphering Keys.....  | 121        |
| 3.2.2.72   | Return Error Request.....  | 121        |
| 3.2.2.73   | Return Error Cause.....  | 121        |
| 3.2.2.74   | Segmentation.....  | 122        |
| 3.2.2.75   | Service Handover .....   | 122        |
| 3.2.2.76   | Source RNC to target RNC transparent information (UMTS) .....    | 122        |
| 3.2.2.77   | Source RNC to target RNC transparent information (cdma2000)..... | 123        |
| 3.2.3  | Signalling Field Element Coding.....                             | 123        |
| 3.2.3.1  | Extra information .....  | 123        |
| 3.2.3.2  | Current Channel type 2 .....                                     | 124        |
| 3.2.3.3  | Target cell radio information.....                               | 125        |
| 3.2.3.4  | GPRS Suspend Information .....                                   | 125        |
| 3.2.3.5  | MultiRate configuration Information .....                        | 125        |
| 3.2.3.6  | Dual Transfer Mode information .....                             | 125        |
| 3.2.3.7  | Inter RAT Handover Info.....                                     | 126        |
| 3.2.3.8  | cdma2000 Capability Information .....                            | 126        |
| 3.2.4  | List of Timers in the BSSMAP Procedures .....                    | 127        |
| 3.3  | SDL Representation Of The Procedures At The BSS .....            | 127        |
| 4  | Broadcast Information Control Channel .....                      | 127        |
| 5  | Vocabulary .....   | 127        |
| 6  | List of diagrams.....  | 129        |
| <b>Annex A (informative): Change control history .....</b> |  | <b>138</b> |
| History .....  |  | 139        |



---

# Foreword

This Technical Specification has been produced by the 3<sup>rd</sup> Generation Partnership Project (3GPP).

The contents of the present document are subject to continuing work within the TSG and may change following formal TSG approval. Should the TSG modify the contents of the present document, it will be re-released by the TSG with an identifying change of release date and an increase in version number as follows:

Version x.y.z

where:

- x the first digit:
  - 1 presented to TSG for information;
  - 2 presented to TSG for approval;
  - 3 or greater indicates TSG approved document under change control.
- y the second digit is incremented for all changes of substance, i.e. technical enhancements, corrections, updates, etc.
- z the third digit is incremented when editorial only changes have been incorporated in the document.

---

# 1 Scope

This Technical Specification (TS) specifies the layer 3 procedures used on the Base Station System (BSS) to Mobile-services Switching Centre (MSC) interface for control of GSM services.

For the purposes of call control and mobility management, messages are not interpreted at the Base Station System (BSS) which acts as a relay function. These messages and procedures are documented in 3GPP TS 24.008 [6], the only relevant issues covering these messages in this TS are those concerned with error conditions at the interface, and the headers that are required for the correct addressing of the messages. This is specified in more detail in 3GPP TS 48.002 [17].

The functional split between MSC and BSS is defined in 3GPP TS 48.002 [16] and states that the BSS is responsible for local radio resource allocation and in order to support this the required procedures between BSS and MSC are defined in detail in this Technical Specification.

3GPP TS 48.002 [16] also states that the BSS is responsible for the scheduling of all CCCH/BCCH messages and therefore some procedures for providing the BSS with the necessary information to be passed on these channels for individual calls (i.e. paging) are defined in this Technical Specification, but the scheduling is not discussed.

This interface and consequently these layer 3 procedures are designed to support BSSs providing one or more cells.

## 1.1 Normative references

The following documents contain provisions which, through reference in this text, constitute provisions of the present document.

- References are either specific (identified by date of publication, edition number, version number, etc.) or non-specific.
- For a specific reference, subsequent revisions do not apply.
- For a non-specific reference, the latest version applies. In the case of a reference to a 3GPP document (including a GSM document), a non-specific reference implicitly refers to the latest version of that document *in the same Release as the present document*.

|      |  |
|------|--|
| [1]  | 3GPP TS 21.905: "Vocabulary for 3GPP Specifications".  |
| [2]  | 3GPP TS 43.003: "Numbering, addressing and identification".  |
| [3]  | 3GPP TS 43.009: "Handover procedures".   |
| [3a] | 3GPP TS 43.032: "Universal Geographical Area Description (GAD)".   |
| [4]  | Void   |
| [5]  | 3GPP TS 43.059: "Functional Stage 2 Description of Location Services in GERAN (Release 4)".              |
| [6]  | 3GPP TS 24.008: "Mobile Radio Interface Layer 3 Specification (CC/MM); Layer 3 specification". [7] Void. |
| [8]  | Void.  |
| [9]  | Void.  |
| [10] | Void.  |
| [11] | Void.  |
| [12] | Void.  |
| [13] | Void.  |
| [14] | Void.  |

- [15] Void.
- [16] 3GPP TS 48.002: "Base Station System - Mobile-services Switching Centre (BSS - MSC) interface; Interface principles".
- [17] 3GPP TS 48.006: "Signalling transport mechanism specification for the Base Station System - Mobile-services Switching Centre (BSS - MSC) interface".
- [18] 3GPP TS 48.020: "Rate adaption on the Base Station System - Mobile-services Switching Centre (BSS - MSC) interface".
- [18a] Void.
- [19] 3GPP TS 48.071: "Location Services (LCS); Serving Mobile Location Centre - Base Station System (SMLC-BSS) interface; Layer 3 specification"
- [19a] 3GPP TS 49.031: "Location Services (LCS); Base Station System Application Part LCS Extension (BSSAP-LE)".
- [20] Void.
- [21] Void.
- [22] Void.
- [23] Void.
- [24] Void.
- [25] Void.
- [26] Void.
- [27] Void.
- [28] 3GPP TS 52.020: " Network Management (NM) procedures and messages".
- [29] Void.
- [30] Void.
- [31] 3GPP TS 25.413: "UTRAN Iu Interface RANAP Signalling".
- [32] 3GPP TS 44.018: "Mobile radio interface layer 3 specification, Radio Resource Control Protocol".
- [33] 3GPP TS 25.331: "RRC protocol specification".
- [34] Void.
- [35] Void.
- [36] Void.
- [37] ITU-T Recommendation E.164: "The international public telecommunication numbering plan".
- [38] ITU-T Recommendation X.25: "Interface between Data Terminal Equipment (DTE) and Data Circuit-terminating Equipment (DCE) for terminals operating in the packet mode and connected to public data networks by dedicated circuit".
- [39] 3GPP TS 43.020: "Security-related network functions".
- [40] 3GPP TS 43.073: "Support of Localised Service Area (SoLSA); Stage 2".
- [41] 3GPP TS 52.008: "Subscriber and equipment trace".
- [42] Void.
- [43] 3GPP TS 45.002: "Multiplexing and multiple access on the radio path".

[44] 3GPP TS 26.103: "Speech Codec List for GSM and UMTS".

## 1.2 Abbreviations

Abbreviations used in this TS are listed in 3GPP TS 21.905 [1].

---

## 2 Application to interface structures

The underlying transport mechanism defined to carry signalling information between the BSS and the MSC is the Message Transfer Part (MTP), and the Signalling Connection Control Part (SCCP) of Signalling System No.7.

The MTP and SCCP are used to support communication between the MSC and two conceptual entities within the BSS, these are:

- the BSS Operation and Maintenance Application Part (BSSOMAP);
- the BSS Application Part (BSSAP).

The BSS Application Part is split into two sub application parts, these are:

- the BSS Management Application Part (BSSMAP);
- the Direct Transfer Application Part (DTAP).

Distribution of messages between the two sub application parts is described in 3GPP TS 48.002 [17].

Figure 1 is a diagrammatical representation of these conceptual entities. It should be noted that this is not intended to imply a particular implementation and is only for the purposes of specifying the interface.

Differentiation between BSSAP and BSSOMAP is by addressing mechanisms within the SCCP, using the subsystem number (see 3GPP TS 48.002 [17]).

### 2.1 The BSS Operation and Maintenance Application Part

If operation and maintenance messages are transferred by means of this interface then they shall use SCCP messages. The application protocol for the Operation and Maintenance Application Part is defined in the 3GPP TS 52 series Technical Specifications. The routing and addressing is provided by the SCCP and allows the MSC and the O&M centre to be addressed directly by the BSS using, for example, two E.164 numbers. The operator may also use an X.25 connection for the transfer of O&M messages between the BSS and the OMC. This option is not further discussed in this Technical Specification.

### 2.2 The Direct Transfer Application Part

The Direct Transfer Application Part (DTAP) is used to transfer call control and mobility management messages between the MSC and the MS. The DTAP information in these messages is not interpreted by the BSS. 3GPP TS 48.002 [17] contains more detail relating to the handling of DTAP messages at the BSS, the multiplexing of the messages onto the relevant signalling channels of the radio interface, and the use of the SCCP services.

Messages received from the MS are identified as DTAP by the Protocol Discriminator Information Element as described in 3GPP TS 24.008 [6], except for Initial Layer 3 messages (see subclause 3.1.16). The majority of radio interface messages are transferred across the BSS MSC interface by the DTAP, the exceptions being messages belonging to the Radio Resource (RR) management protocol.

### 2.3 The BSS Management Application Part

The BSSMAP supports all of the procedures between the MSC and the BSS that require interpretation and processing of information related to single calls, and resource management.

Some of the BSSMAP procedures result in, or are triggered by, Radio Resource (RR) management messages defined in 3GPP TS 24.008 [6]. The BSSMAP procedures are described in clause 3.

## 2.4 Handling of abnormal events related to the BSSAP Header

The BSSAP header is specified in 3GPP TS 48.002 [17]. Several abnormal events may be detected by the receiver:

- use of a reserved value in the DLCI or discriminator;
- length octet with value zero;
- length octet with a value inconsistent with that indicated by the SCCP.

In these cases the receiver may send a BSSMAP CONFUSION message as specified in subclause 3.2.1. If so, depending on the error in the BSSAP header, the error pointer shall be set to one of the values reserved for the BSSAP header in subclause 3.2.2.32.

Spare bits in the BSSAP header shall not be checked by the receiving entity.

---

# 3 The BSS Management Application Part

## 3.1 BSSMAP Procedures

This subclause describes the procedures used in the BSS Management Application Part. There are the following main procedures:

|   |                                       |                  |
|---|---------------------------------------|------------------|
| * | Assignment                            | figure 2         |
| # | Blocking                              | figure 10 and 25 |
| # | Resource indication                   | figure 12        |
| # | Reset                                 | figure 11        |
| * | Handover required indication          | figure 4         |
| * | Handover resource allocation          | figure 5         |
| * | Handover execution                    | figure 3         |
| # | Handover candidate enquiry            | figure 13        |
| * | Release                               | figures 6 and 7  |
| # | Paging                                | figure 15        |
| # | Flow control                          | figure 14        |
| * | Classmark update                      | figure 9         |
| * | Cipher mode control                   | figure 17        |
| * | Trace invocation                      |                  |
| * | Initial MS message                    |                  |
| * | Queuing indication                    |                  |
| * | Data link control SAPI not equal to 0 | figure 18        |
| # | Reset circuit                         |                  |
| * | PDSS1 flow control                    |                  |
| * | Circuit re-selection                  | figure 26        |
| * | Location Aquisition                   |                  |
| # | Connectionless Information Transfer   |                  |
| * | Common ID                             |                  |

These procedures are documented separately and are intended to be used by the operators/manufacturers to build up complete call sequences, in a flexible manner. Any sequences given where more than one procedure is shown concatenated are only for illustrative purposes.

Each of the above procedures is qualified by either an asterisk (\*) or a hash symbol (#). The hash symbol (#) denotes a global procedure which concerns a complete cell or BSS, or specific terrestrial circuits. The asterisk symbol (\*) denotes a dedicated procedure which concerns a single dedicated radio resource on the radio interface, or in the case of a multislot configuration, all radio resources allocated to one mobile station.

Messages used to support global procedures are sent using the connectionless services of the SCCP.

Messages used to support dedicated procedures are sent using the connection oriented services of the SCCP, on the connection which has been set up to support that call or transaction. The establishment of SCCP connections is detailed in 3GPP TS 48.002 [17].

In the following description of each procedure it is explicitly stated whether the procedure is global or not, and hence the type of SCCP service used to support the procedure is defined.

The handling of unknown terrestrial circuits is defined in subclause 3.1.19.6 and the procedures of subclause 3.1.19.6 take precedence over those of the rest of subclause 3.1. The procedures of the rest of subclause 3.1 assume that the terrestrial circuit is known by the entity concerned.

### 3.1.1 Assignment

The purpose of the assignment procedure is to ensure that the correct dedicated radio resource(s) can be allocated or reallocated to a MS that requires it. However, the initial random access by the MS and "Immediate Assignment" to a DCCH is handled autonomously by the BSS without reference to the MSC.

#### 3.1.1.1 Successful Operation

The initial conditions are assumed to be that the MS is in contact with the fixed infrastructure of a PLMN by means of one or more dedicated radio resources (and possibly a terrestrial resource) and that the MSC has analysed any relevant call control information and wishes to allocate or reallocate to the MS one or more radio resources (and possibly a terrestrial resource).

The MSC is the entity that carries out the necessary analysis on the call control information received from the MS or fixed network customer.

On the basis of this analysis a resource request is made to the appropriate BSS by sending it an ASSIGNMENT REQUEST message. This message contains details of the resource(s) required (for instance channel rate, channel type, data adaptation, priority level etc.). If the requested resource(s) is/are for speech or data it also may indicate the terrestrial circuit that shall be used between the MSC and BSS. The description of the resource(s) can either be a complete specification, or give the BSS some freedom in the selection (for instance channel rate selection, speech version selection etc.). The ASSIGNMENT REQUEST message may also contain CLASSMARK information in case such information is available in the MSC, but assumed not to be available in the BSS. A full description of the message is given in subclause 3.2.1.1.

In this specification a "pool" is a group of circuits supporting the same channel types.

The ASSIGNMENT REQUEST message is sent via the BSSMAP and is analysed within the BSS. Based on this analysis, which is not defined further in this Technical Specification, the BSS chooses the appropriate radio resource(s) and allocates the appropriate resources for transcoding, rate adaptation etc. On the terrestrial route connecting the BSS and MSC, certain circuits can be used for different combinations of bearer capabilities. This can be modelled by grouping the circuits into "pools" supporting the same channel types. The MSC holds this information as route data. If the MSC allocates an A interface circuit, it should only ever ask for resources from the BSS that it knows are not totally incompatible with the nominated circuit. The BSS will construct and send the appropriate radio assignment messages, if required (i.e., if the radio resource(s) has/have to be changed), as described in 3GPP TS 44.018 [32] and start timer T10. The ASSIGNMENT REQUEST message includes sufficient information to allow the BSS to construct the necessary layer 3 radio messages. If the BSS allocates the A interface circuits, and such a circuit is needed, the BSS shall allocate a circuit.

In the case where several circuit pools (groups of circuits supporting the same channel types) are available on the BSS MSC interface, the terrestrial circuit allocated by the MSC, if any, is chosen taking into account the circuit pool the circuit belongs to and the required channel type.

The management of priority levels is implementation dependent, under operator control.

If queuing is managed, new requests which cannot be served immediately are put in the queuing file according to the indicated priority levels.

The priority levels and the preemption indicators may (singularly or in combination) be used to determine whether the assignment has to be performed unconditionally and immediately. This would lead to triggering of the preemption

procedure which may then cause the forced release or forced handover of a lower priority connection if no free resource is immediately available.

Whilst the process and the extent of the preemption procedure is operator dependent, the preemption indicators (refer to subclause 3.2.2.18.), if given in the ASSIGNMENT REQUEST, shall be treated on a per connection basis as follows:

- the last received "Preemption Vulnerability indicator" and priority levels shall prevail.
- if the "Preemption Capability indicator" bit is set to 1, then this allocation request can trigger the running of the preemption procedure.
- if the "Preemption Capability indicator" bit is set to 0, then this allocation request cannot trigger the preemption procedure.
- if the "Preemption Vulnerability" bit is set to 1, then this connection is vulnerable and shall be included in the preemption process or procedure and as such may be subject to forced release or forced handover.
- if the "Preemption Vulnerability" bit is set to 0, then this connection is not vulnerable to preemption and shall not be included in the preemption process and as such may not be subject to forced release or forced handover.
- if no priority Information Element has been received, both "Preemption Capability" and "Preemption Vulnerability" bits shall be regarded as set to 0.

The BSS shall ignore the classmark information included in the ASSIGNMENT REQUEST message if such information has already been received from the MS.

The radio assignment procedure on the radio path is described in 3GPP TS 44.018 [32]. When the BSS is satisfied that the radio assignment procedure has been successfully accomplished (e.g. by receipt of a radio interface ASSIGNMENT COMPLETE message) it will stop timer T10 and return an ASSIGNMENT COMPLETE message over the BSS MSC interface. This will implicitly release the old dedicated radio resource(s) at the BSS. If an intra-BSS cell change has occurred during the assignment, the new cell identity is included in the ASSIGNMENT COMPLETE message and a HANDOVER PERFORMED message is not required. If the MSC gave the BSS some freedom in resource type selection, the choices made by the BSS are indicated in the ASSIGNMENT COMPLETE message. If the BSS has to allocate a circuit, the ASSIGNMENT COMPLETE message includes the identity of the circuit allocated by the BSS.

When several circuit pools are present on the BSS MSC interface, and when the circuit is allocated by the MSC, the "circuit pool" information element shall be included in the ASSIGNMENT COMPLETE. The "circuit pool" field will indicate to the MSC the circuit pool of the CIC given in the ASSIGNMENT REQUEST message.

If the assignment did not require a change of radio resource(s), and consequently no 3GPP TS 44.018 [32] radio assignment procedure had been invoked, then the ASSIGNMENT COMPLETE message shall be returned to the MSC as soon as the requested resources have been allocated within the BSS.

If the assignment requires a change of terrestrial circuit or in the case of assignment for signalling the release of a previously used terrestrial circuit, the change or release shall be performed before the ASSIGNMENT COMPLETE message is sent and the BSS shall consider that the old terrestrial circuit is idle.

After the completion of the assignment procedure, until the connection is released or the MSC performs a new assignment, any dedicated resource assigned to the mobile station, e.g. at internal handover, must be in accordance with the description in the ASSIGNMENT REQUEST message.

In the case of voice group calls the MSC may inform the BSS to which voice group call an MS belongs to and whether the MS is a talker or listener in the voice group call, the BSS may decide to allocate and assign a voice group call channel relating to the group call reference. If the BSS allocates a voice group call channel it will send the ASSIGNMENT COMPLETE message and then immediately afterwards send a CLEAR REQUEST cause "Joined group call channel".

In the case where localised service area is supported the MSC may inform the BSS as to which LSA identities that the mobile has preferences by sending the LSA INFORMATION message. The BSS stores this information and uses it when determining the target cell list for handover. The algorithm for determining the target cell list for handover is not defined further in this technical specification. The reception of another message containing LSA identities for the connection will replace the LSA identities previously received. The BSS, in the case where localised service area is supported, will indicate the LSA identity of the serving cell in the ASSIGNMENT COMPLETE if it corresponds to one of the LSA identities received in the latest LSA INFORMATION or the HANDOVER REQUEST messages.

In the case where Intersystem handover to other RAT's is supported, the MSC may inform the BSS, if preference for other radio access technologies (Service based handover) shall be applied to the MS connection. In such cases the MSC sets the Service Handover Information Element accordingly in the ASSIGNMENT REQUEST message. The Service Handover information is stored in the BSS throughout the connection and is used in the Handover evaluation process.

### 3.1.1.2 Assignment Failure

The following failure conditions may occur:

The BSS may not be able to use the terrestrial resource that the MSC has indicated in which case an ASSIGNMENT FAILURE message will be returned to the MSC with the cause set to "requested terrestrial resource unavailable".

If the requested channel type or resource (e.g. channel rate, speech version, etc.) indicated in the ASSIGNMENT REQUEST message is not available in the BSS, then an ASSIGNMENT FAILURE message shall be returned to the MSC. The appropriate failure cause will be included in the message (Cause value: "requested transcoding/rate adaptation unavailable" or "requested speech version unavailable").

If, on reception by the BSS of an ASSIGNMENT REQUEST message allocating a circuit, the circuit pool implied by the CIC information element is incompatible with the channel type indicated (that is, the pool does not support any of the radio resources indicated by the channel type) an ASSIGNMENT FAILURE shall be returned to the MSC with the failure cause set to "circuit pool mismatch".

If, on reception by the BSS of an ASSIGNMENT REQUEST message allocating a circuit, the circuit pool implied by the CIC is compatible with the channel type indicated (that is, the pool supports at least one of the radio resource types indicated by the channel type), but the BSS still wishes to change the circuit pool, it sends an ASSIGNMENT FAILURE with the cause "switch circuit pool" and the "circuit pool list" information element.

The "circuit pool" information element, when present in the ASSIGNMENT FAILURE, indicates to the MSC which circuit pool the CIC indicated in the ASSIGNMENT REQUEST belongs to. This can be used by the MSC to correct its tables (CIC/circuit pool). The "circuit pool list" information element, when present in the ASSIGNMENT FAILURE, is used when the BSS wishes to indicate to the MSC its preferred circuit pools. The circuit pools in the "circuit pool list" information element shall be given in order of preference. In the case of an ASSIGNMENT FAILURE with the cause "circuit pool mismatch", the MSC may decide to block the circuit and to send an O & M notification.

The BSS may not receive a radio interface ASSIGNMENT COMPLETE message from the MS in which case the timer T10 will expire. In this case an ASSIGNMENT FAILURE message is returned to the MSC and the assignment procedure is terminated (cause value: radio interface message failure).

If the cell for which the assignment is intended is congested, the BSS may indicate an impending directed retry attempt by sending ASSIGNMENT FAILURE (Cause value: directed retry).

If the radio channel assignment fails for any other reason then an ASSIGNMENT FAILURE message will be returned to the MSC, the procedure will terminate, and the associated references concerning the old dedicated resource(s) should be maintained until explicitly released by the MSC. It should be noted that if the MS fails to assign after receiving a radio interface ASSIGNMENT COMMAND and returns to the old channels as detailed in 3GPP TS 24.008 [6], then the radio interface ASSIGNMENT FAILURE message received from the MS will cause an ASSIGNMENT FAILURE message to be returned to the MSC (cause value: "Radio interface failure, reversion to old channel").

If the BSS has received LSA INFORMATION or HANDOVER REQUEST message indicating LSA only access and all available radio resources are outside the allowed LSAs, assignment may fail and ASSIGNMENT FAILURE message may be sent to the MSC (cause value: "LSA not allowed").

If all available radio resources are defined for exclusive access and the connection is not allowed to access these resources, assignment may fail and ASSIGNMENT FAILURE message may be sent to the MSC (cause value: "LSA not allowed").

Other possible Cause values which may be returned with the ASSIGNMENT FAILURE message are: "equipment failure", "no radio resource available", "O&M intervention". If an unrecognised cause value is received, the Class of the cause value should be used to determine the MSC's action.

In the case where the MSC has attempted to assign a terrestrial circuit and an ASSIGNMENT FAILURE message has been returned then both the MSC and the BSS shall consider that the terrestrial circuit is idle (except as described below in subclause 3.1.1.3) and therefore no explicit clearing sequence is needed.



The MSC may not be able to use the terrestrial resource that the BSS has indicated. In this case, the procedure is nevertheless considered terminated successfully, and it is up to the MSC to correct the situation, e.g., by a circuit re-selection procedure.

All messages concerned with an assignment are sent using the connection oriented mode of the SCCP.

### 3.1.1.3 Abnormal Conditions

If the BSS receives an ASSIGNMENT REQUEST message calling up a terrestrial circuit that is already assigned to another call then an ASSIGNMENT FAILURE message will be returned with a Cause value of: "terrestrial circuit already allocated" and no action will be taken on the radio interface.

If the BSS receives an ASSIGNMENT REQUEST message allocating a terrestrial circuit which has been blocked by a global block message, then an ASSIGNMENT FAILURE message shall be sent (Cause value: "requested terrestrial resource unavailable"). A single global BLOCK message (not repeated and not guarded by timer T1) shall be sent for that concerned terrestrial circuit.

If an external handover becomes necessary during an assignment, for reasons of radio conditions or congestion (directed retry), the BSS may initiate the handover whilst the assignment is in progress. In this situation, if a HANDOVER COMMAND is received by the BSS, it must not be ignored.

## 3.1.2 Blocking and Unblocking

As described in subclause 3.1.1 the assignment procedure depends upon one side, the MSC or the BSS, choosing the terrestrial resource to be used. If the entity on one side puts out of service any terrestrial circuit, it needs to inform the peer entity on the other side of the interface. This is performed by using a simple blocking/unblocking procedure. The block messages used to support this procedure are sent as global messages (i.e. using the SCCP connectionless mode). Each message refers to one or more terrestrial circuits accessed through the BSS MSC interface. The circuit is identified by its Circuit Identity Code.

The support of blocking/unblocking procedures is dependent on which side allocates the circuits.

A circuit is said to be « locally blocked » on a given side if it has been put out of service for a local reason, and to be « remotely blocked » if a BLOCK message about this circuit has been received from the peer entity.

### 3.1.2.1 Successful Operation

The procedure operates as follows:

Initial conditions are assumed to be that all circuits are remotely unblocked.

An entity may locally block a terrestrial circuit because:

- Operation and Maintenance intervention makes the circuit unavailable for use (Cause value: "O and M intervention").
- An equipment failure makes the circuit unavailable (Cause value: "equipment failure").
- Radio resource is not accessible from the terrestrial circuit (Cause value: "no radio resource available").

When and if the party that does not allocate the circuits (the Circuit Slave) decides to locally block a terrestrial circuit, it shall immediately mark that terrestrial circuit as "blocked" (to stop any future allocation of that terrestrial circuit) and shall then send a block message to the peer entity allocating the circuits (the Circuit Master) and start timer T1 (T20, T21, T22).

The BLOCK message contains the Circuit Identity Code indicating the terrestrial circuit that is to be remotely blocked and a Cause Information Element indicating the reason for blocking. Typical Cause values are: "no radio resources available", "O and M intervention", "equipment failure".

A BLOCK message in the MSC to BSS direction may also contain an indication that the connection using the circuit, if any, must be released ; in such a case the circuit master shall check if the circuit is in use and shall release the connection that uses it.

NOTE: This allows the MSC to simultaneously block the circuit and to release the connection using the circuit, if any, and then to prevent use of the circuit by the BSS between connection release and blocking.

If the CIRCUIT GROUP BLOCK message is applied by the circuit slave the circuits to be remotely blocked are indicated in the status field of the Circuit Identity Code List (3.2.2.31).

Receipt of a block message (BLOCK or CIRCUIT GROUP BLOCK) at the circuit master from the circuit slave will indicate to the circuit master that the identified circuits are unavailable for reselection. If a call is in progress on any of the identified terrestrial circuits then it will be unaffected by this procedure unless explicitly requested, the circuits will however be "camp on blocked". Such circuits shall be remotely blocked as soon as that call is no longer in progress, or active.

On receipt of a BLOCK message asking for the release of the connection using the circuit if any, and if the BSS detects that there exists a connection using the indicated circuit, the BSS shall attempt to release that connection, e.g., by sending a CLEAR REQUEST message on the corresponding SCCP connection. As specified in subclause 3.1.17, if the SCCP connection has been lost, the BSS will detect it when attempting to release the connection and the whole connection is released as a consequence.

An appropriate blocking acknowledge message (BLOCKING ACKNOWLEDGE or CIRCUIT GROUP BLOCKING ACKNOWLEDGE) will be returned to the circuit slave by the circuit master to acknowledge receipt of the block message and to indicate that any necessary action has been taken.

The CIRCUIT GROUP BLOCKING ACKNOWLEDGEMENT message is accepted as the appropriate acknowledgement only if the indicated Circuit Identity Code and the returned Range field of the Circuit Identity Code List match the corresponding parameter values of the respective initiating message. Otherwise the message is considered as not expected.

On receipt of the blocking acknowledge the circuit slave shall stop timer T1 (T20, T21, T22).

The resource involved will be assumed to be remotely blocked by the circuit master until either an unblock (UNBLOCK or CIRCUIT GROUP UNBLOCK) or RESET message is received relevant to that resource.

If the circuit slave wishes to unblock a blocked circuit and return it to service then it shall immediately mark the circuit as "locally unblocked" and then send an unblock message, and start timer T1 (T20, T21, T22).

If an unblock message (UNBLOCK or CIRCUIT GROUP UNBLOCK) is received at the circuit master for a blocked resource then the resource will be marked as not remotely blocked and an unblocking acknowledge message (UNBLOCKING ACKNOWLEDGE or CIRCUIT GROUP UNBLOCKING ACKNOWLEDGE) will be returned to the circuit slave. The circuit slave shall stop timer T1 (T20, T21, T22) on receipt of this unblocking acknowledge.

The CIRCUIT GROUP UNBLOCKING ACKNOWLEDGEMENT message is accepted as the appropriate acknowledgement only if the indicated Circuit Identity Code and the returned Range field of the Circuit Identity Code List match the corresponding parameter values of the respective initiating message. Otherwise the message is considered as not expected.

Figure 10 shows an overview of the blocking procedure in the case the circuit slave is the BSS.

NOTE: Timer T1 is used to supervise a single circuit block/unblock procedure on the BSS side, whilst T20 is used to supervise the circuit group block/unblock procedure on the BSS side, timer T21 is used to supervise a single circuit block/unblock procedure on the MSC side, and T22 is used to supervise the circuit group block/unblock procedure on the MSC side.

### 3.1.2.2 Abnormal Conditions

If a blocking acknowledge message is not received for a block message within T1 (T20, T21, T22) seconds then the block message will be repeated. If this occurs a second time the circuits will be kept marked as locally blocked, and the situation must then be resolved internally within the circuit slave or by O&M procedures.

If an unblocking acknowledge message is not received for an unblock message before expiry of timer T1 (T20, T21, T22) then the unblock message will be repeated. If this occurs a second time, this situation may be reflected to the O&M, which shall resolve the possible conflict. The unblock message is repeated at most one time. Whatever the outcome of possible repetitions, the concerned circuits remain locally "unblocked".

If the MSC allocates the circuits, and an ASSIGNMENT REQUEST or HANDOVER REQUEST message is received by the BSS allocating a circuit which is marked at the BSS as blocked then an ASSIGNMENT FAILURE message or a HANDOVER FAILURE message (respectively) followed by a BLOCK message shall be sent to the MSC.

If the BSS allocates the circuits, and an ASSIGNMENT COMPLETE, HANDOVER REQUEST ACKNOWLEDGE or CHANGE CIRCUIT ACKNOWLEDGE message is received by the MSC allocating a circuit which is marked at the MSC as blocked, it is up to the MSC how to correct the situation, e.g., by performing a circuit re-selection procedure and sending a BLOCK message.

### 3.1.2.2.1 Applying to the Single Circuit Block Procedure

- i) If a BLOCK message is received for a circuit already remotely blocked, a BLOCKING ACKNOWLEDGE message will be sent.
- ii) If an UNBLOCK message is received for a remotely unblocked circuit, an UNBLOCKING ACKNOWLEDGE message will be sent.
- iii) If a BLOCKING ACKNOWLEDGE message, which is not expected as an acknowledgement for a BLOCK message, is received:
  - a) relating to a circuit which is locally blocked, the BLOCKING ACKNOWLEDGE message is discarded.
  - b) relating to a circuit, which is not locally blocked, then an UNBLOCK message will be sent.
- iv) If an UNBLOCKING ACKNOWLEDGE message, which is not expected as an acknowledgement for an UNBLOCK message, is received:
  - a) relating to a circuit which is not locally blocked, the received UNBLOCKING ACKNOWLEDGE message is discarded.
  - b) relating to a circuit, which is locally blocked, then a BLOCK message will be sent.

### 3.1.2.2.2 Applying to the Circuit Group Block Procedure

- v) If a CIRCUIT GROUP BLOCK message is received relating to remotely blocked circuits then blocking acknowledgement indications for those circuits are given in the status field of the corresponding CIRCUIT GROUP BLOCKING ACKNOWLEDGE message which will be sent in response.
- vi) If a CIRCUIT GROUP UNBLOCK message is received relating to circuits which are not remotely blocked then unblocking acknowledgement indications for those circuits are given in the status field of the corresponding CIRCUIT GROUP UNBLOCKING ACKNOWLEDGE message which will be sent in response.
- vii) When the circuit master upon receipt of a CIRCUIT GROUP BLOCK (UNBLOCK) message is not able to give an appropriate blocking (unblocking) acknowledgement indication for each Circuit Identification Code (e.g. because that/those Circuit Identification Code(s) is (are) not allocated to any circuit at the receiving entity) for which a block (unblock) indication is given in the status field of the received CIRCUIT GROUP BLOCK (UNBLOCK) message, then no blocking (unblocking) acknowledgement relating to that/those Circuit Identification Code(s) will be given in the status field of the corresponding CIRCUIT GROUP BLOCKING (UNBLOCKING) ACKNOWLEDGE message which will be sent in response.
- viii) If a CIRCUIT GROUP BLOCKING ACKNOWLEDGE message in response to a CIRCUIT GROUP BLOCK message is received by the circuit slave containing in the status field no blocking acknowledgement for circuits which are to be blocked due to the previously sent CIRCUIT GROUP BLOCK message, then the CIRCUIT GROUP BLOCK message will be repeated for the circuit(s) concerned.

If this occurs a second time the concerned circuit(s) will be kept marked as locally blocked, and the situation must then be resolved internally within the circuit slave or by O&M procedures.
- ix) The same rule applies to the Circuit Group Unblocking procedure with the only difference that the involved terrestrial circuits are kept marked as locally "not blocked".
- x) If a CIRCUIT GROUP BLOCKING ACKNOWLEDGE message in response to a CIRCUIT GROUP BLOCK message is received by the circuit slave containing in the status field blocking acknowledgement indications for

circuits which are not to be blocked, then an appropriate unblock message will be sent for the circuit(s) concerned.

- xi) If a CIRCUI T GROUP UNBLOCKING ACKNOWLEDGE message in response to a CIRCUI T GROUP UNBLOCK message is received by the circuit slave containing in the status field unblocking acknowledgement indications for circuits which have to remain marked as locally blocked then an appropriate block message will be sent for the circuit(s) concerned.
- xii) If a CIRCUI T GROUP BLOCKING ACKNOWLEDGE message which is not expected and not accepted as an acknowledgement for a CIRCUI T GROUP BLOCK message is received:
  - a) relating to circuits which all are in the status locally blocked, then the received CIRCUI T GROUP BLOCKING ACKNOWLEDGE message will be discarded;
  - b) related to circuits part or all of which are not in the status locally blocked then an appropriate unblock message will be sent for the relevant circuit(s).
- xiii) If a CIRCUI T GROUP UNBLOCKING ACKNOWLEDGE message which is not expected and not accepted as an acknowledgement for a CIRCUI T GROUP UNBLOCK message is received:
  - a) relating to circuits none of which is in the status locally blocked, then the received CIRCUI T GROUP UNBLOCKING ACKNOWLEDGE message will be discarded;
  - b) related to circuits part or all of which are locally blocked then an appropriate block message will be sent for the relevant circuit(s).

### 3.1.3 Resource Indication

The purpose of the resource indication procedure is:

- To inform the MSC of the amount
  - of radio resource that is spare at the BSS and available for traffic carrying purposes; and
  - of the total amount of the accessible radio resource (i.e. available for service or currently assigned).

This cannot easily be derived from the traffic that the MSC is carrying. The MSC may take these pieces of information into account for the external handover decision.

#### 3.1.3.1 Successful Operation

The procedure relates to a single cell.

The MSC determines the resource information (i.e. the resource available information and optionally the total resource accessible information) and the manner in which the BSS transfers this resource information to the MSC by sending a RESOURCE REQUEST message to the BSS. This message shall contain a Resource Indication Method Information Element which can be set to one of the following values:

- i) (Spontaneous resource information expected): The BSS shall send the first RESOURCE INDICATION message without any resource information to the MSC immediately as an acknowledgement to the RESOURCE REQUEST message and then any further RESOURCE INDICATION messages spontaneously every time conditions, defined by O&M, are met in the BSS for the considered cell (e.g. traffic thresholds, or time interval between two messages). If the O&M conditions for sending RESOURCE INDICATION messages are met, the BSS may use the Periodicity IE received in the RESOURCE REQUEST message to determine the time interval between indications, except that, if the MSC sets the Periodicity IE to zero then the BSS shall ignore the Periodicity IE. The BSS stays in this mode until the receipt of a new RESOURCE REQUEST message for the same cell, or a reset occurs;
- ii) (One single resource information expected): The BSS shall return a single RESOURCE INDICATION message with some resource information immediately. If the RESOURCE REQUEST message does not contain an Extended Resource indicator IE the BSS shall then cease any resource information transfer related to the cell until the receipt of either a new RESOURCE REQUEST message or a reset. If the RESOURCE REQUEST message contains an Extended Resource Indicator IE the BSS shall obey the 'Subsequent Mode' field;

iii) (Periodic resource information expected): The BSS shall return a RESOURCE INDICATION message with some resource information immediately, and then periodically, with a period set by MSC\*, until the receipt of either a new RESOURCE REQUEST message for the same cell or a reset.

\* (The period shall equal the value of the periodicity parameter times 100 ms. If the value of the periodicity parameter is zero, then the message should be treated as one containing an incorrect value according to subclause 3.1.19.4, case 2.)

iv) (No resource information expected): The BSS shall immediately return a single RESOURCE INDICATION message without any resource information as an acknowledgement to the RESOURCE REQUEST message and then the BSS to MSC transfer of resource information related to the cell is disabled until the receipt of either a new RESOURCE REQUEST message for the same cell or a reset.

The default mode is iv); after a reset, this mode is set for all the cells of a BSS.

The transfer of resource information related to a given cell from the BSS to the MSC occurs when the Resource Indication Method Information Element is set to one of the values i) to iii) in the BSS. The BSS sends RESOURCE INDICATION messages to the MSC, under the conditions explained above. The RESOURCE INDICATION message shall contain the Resource Indication Method Information Element with the same value as it was requested by the MSC, i.e. the BSS is not allowed to select a method different from the one requested by the MSC.

Furthermore, the RESOURCE INDICATION message may contain the Resource Available IE and the Total Resource Accessible IE dependent on the selected method and, in case of the Total Resource Accessible IE, also dependent on the request from the MSC. If the RESOURCE INDICATION message is just taken as a simple acknowledgement as stated in method i) and iv), the Total Resource Accessible IE shall not be returned independent of whether it was requested by the MSC or not.

For each idle channel the level of interference will be averaged over a period of Intave. (Intave is a parameter set by O&M command on a per cell basis). This averaging will be performed immediately before the transmission of the RESOURCE INDICATION message. The result of this averaging will be used to classify the average interference level on the idle channels into five interference bands.

The Resource Available Information Element contains two pieces of information for each of the five interference bands:

- The number of half rate TCHs available in that band.
- The number of full rate TCHs available in that band.

The levels of the five bands are defined by O&M.

## 3.1.4 Reset

### 3.1.4.1 Global Reset Procedure

The purpose of the reset procedure is to initialise the BSS and MSC in the event of a failure. The procedure is a global procedure applying to a whole BSS, and therefore all messages relating to the reset procedure are sent as global messages using the connectionless mode of the SCCP.

If only a limited part of the MSC or BSS has suffered a failure then clearing procedures can be used to clear only those affected calls.

#### 3.1.4.1.1 Reset at the BSS

In the event of a failure at the BSS which has resulted in the loss of transaction reference information, a RESET message is sent to the MSC. This message is used by the MSC to release affected calls and erase all affected references, and to put all circuits into the idle state.

After a guard period of T2 seconds a RESET ACKNOWLEDGE message is returned to the BSS indicating that all references have been cleared.

After the sending of the RESET to the MSC a BSS that does not allocate the circuits shall initiate blocking procedures (Block or Circuit group block procedures) for all circuits that are locally blocked on the BSS side, the MSC shall

respond as specified in subclause 3.1.2. The sending of block messages shall be done without waiting for the acknowledgement to the RESET message.

Upon receipt of a RESET message from the BSS an MSC that does not allocate the circuits shall send block messages (BLOCK or CIRCUIT GROUP BLOCK) for all circuits that are locally blocked on the MSC side, the BSS shall respond to these with blocking acknowledge messages as described in subclause 3.1.2.

#### 3.1.4.1.2 Reset at the MSC

In the event of a failure at the MSC which has resulted in the loss of transaction reference information, a RESET message is sent to the BSS. This message is used by the BSS to release affected calls and erase all affected references.

After the sending of the RESET to the BSS, an MSC that does not allocate the circuits shall initiate blocking procedures (Block or Circuit group block procedures) for all circuits that are locally blocked on the MSC side, the BSS shall respond as specified in subclause 3.1.2. The sending of block messages shall be done without waiting for the acknowledgement to the RESET message.

Upon receipt of a RESET message from the MSC a BSS that does not allocate the circuits shall send block messages (BLOCK or CIRCUIT GROUP BLOCK) for all circuits that were previously locally blocked on the BSS side, the MSC shall respond to these with blocking acknowledge messages as described in subclause 3.1.2.

After a guard period of T13 seconds a RESET ACKNOWLEDGE message is returned to the MSC, indicating that all MSs which were involved in a call are no longer transmitting and that all references at the BSS have been cleared.

#### 3.1.4.1.3 Abnormal Conditions

##### 3.1.4.1.3.1 Abnormal Condition at the BSS

If the BSS sends a RESET message to the MSC and receives no RESET ACKNOWLEDGE message within a period T4 then it shall repeat the entire reset procedure. The sending of the RESET message is repeated a maximum of "n" times where n is an operator matter. After the n-th unsuccessful repetition the procedure is stopped and the maintenance system is informed.

##### 3.1.4.1.3.2 Abnormal Condition at the MSC

If the MSC sends a RESET message to the BSS and receives no RESET ACKNOWLEDGE message within a period T16 then it shall repeat the entire reset procedure. The sending of the RESET message is repeated a maximum of "n" times where n is an operator matter. After the n<sup>th</sup> unsuccessful repetition the procedure is stopped and the maintenance system is informed.

#### 3.1.4.2 Reset Circuit

The purpose of the reset circuit procedure is to restore the information in MSC/BSS in the case of a failure which has affected only a small part of the equipment (e.g. abnormal SCCP connection release).

##### 3.1.4.2.1 Reset Circuit at the BSS

If a circuit has to be put to idle at the BSS due to an abnormal SCCP-connection release, a RESET CIRCUIT message will be sent to the MSC. When the MSC receives this message, it clears the possible call and puts the circuit, if known, to the idle state. If the circuit is known, a RESET CIRCUIT ACKNOWLEDGE message is returned to the BSS. If circuit allocation is done by the BSS and if the circuit is locally blocked at the MSC a BLOCK message shall be returned to the BSS. The BSS shall then respond with a BLOCKING ACKNOWLEDGE message, as described in subclause 3.1.2. If the circuit is unknown in the MSC, an UNEQUIPPED CIRCUIT message is returned to the BSS.

Timer T19 is used at the BSS to supervise the reset circuit procedure. If the timer elapses before a response (RESET, RESET CIRCUIT ACKNOWLEDGE or UNEQUIPPED CIRCUIT) is returned to the BSS, the procedure is repeated.

### 3.1.4.2.2 Reset Circuit at the MSC

If a circuit has to be put to idle at the MSC due to an abnormal SCCP-connection release, a RESET CIRCUIT message will be sent to the BSS. When the BSS receives a RESET CIRCUIT message, it shall respond with a RESET CIRCUIT ACKNOWLEDGE message in case the circuit can be put to idle. If circuit allocation is done by the MSC and if the circuit is locally blocked at the BSS a BLOCK message shall be returned to the MSC. The MSC shall then respond with a BLOCKING ACKNOWLEDGE message, as described in subclause 3.1.2. If the circuit is unknown at the BSS, the BSS shall return an UNEQUIPPED CIRCUIT message to the MSC.

Timer T12 is used at the MSC to supervise the reset circuit procedure. If the Timer elapses before a response (RESET, RESET CIRCUIT ACKNOWLEDGE, UNEQUIPPED CIRCUIT or BLOCK) the reset circuit procedure is repeated.

### 3.1.4.2.3 Abnormal conditions

If a RESET message is received after sending of a RESET CIRCUIT message and before receipt of the corresponding response the respective reset circuit procedure is stopped, i.e. reception of the corresponding RESET CIRCUIT ACKNOWLEDGE message is not required and no repetition is necessary.

If a RESET CIRCUIT message is received immediately after a RESET CIRCUIT message has been sent for the same circuit, the corresponding acknowledgement messages are returned.

The sending of the RESET CIRCUIT message is repeated a maximum of "n" times where n is an operator matter. After the n-th unsuccessful repetition the procedure is stopped and the maintenance system is informed.

## 3.1.5 External Handover

The details of the radio information as far as handover is concerned are given in 3GPP TS 24.008 [6]. The relevant network information is given in 3GPP TS 43.009 [3].

Using this protocol the BSS should support handover transitions to and from any combinations of the following:

- Channel
- SDCCH
- Full Rate TCH
- Half Rate TCH
- Multiple Full Rate TCHs

In this specification three procedures are defined which can be used for handover. They are:

- Handover Required Indication;
- Handover Resource Allocation;
- Handover Execution.

(Figure 16 shows an example of a complete handover procedure.)

For any HANOVER REQUIRED message at most one HANOVER COMMAND message may be sent.

In the case of inter-MSC handover the term "the MSC" in this subclause is taken to mean the relevant MSC in the handover operation.

The handover procedures are specified in the following subclauses.

All messages concerned with handover, with the exception of HANOVER CANDIDATE ENQUIRE and HANOVER CANDIDATE RESPONSE messages, are sent using the connection oriented mode of the SCCP.

### 3.1.5.1 Handover Required Indication

The handover required indication procedure allows a BSS to request that a handover is to be carried out for a particular MS, currently allocated one or more dedicated resources. This is done by generating a HANOVER REQUIRED message and sending it from the BSS to the MSC. If so required by the BSS, the MSC informs the BSS if the handover cannot be carried out. This is done by a HANOVER REQUIRED REJECT message. The HANOVER REQUIRED message is sent using the BSSAP SCCP connection already set up for that transaction. As part of the BSS's functions, the BSS continually monitors all radio information and compares it with parameters such that if the transmission quality of a given parameter (or set of parameters) passes a predetermined threshold (set by O&M) then a HANOVER REQUIRED message is generated and sent to the MSC.

#### 3.1.5.1.1 Generation of the HANOVER REQUIRED message

Generation of the HANOVER REQUIRED message can be for the following reasons:

- The BSS has detected that a radio reason exists for a handover to occur.
- The MSC has initiated a handover candidate enquiry procedure, and this MS is currently a candidate.
- A cell change is required at call setup due to congestion, e.g. directed retry.

The HANOVER REQUIRED message contains the following information elements:

- Message Type;
- Cause;
- Cell Identifier List (preferred).

It should also contain the information elements: "Current channel type 1", "Old BSS to New BSS information" and, in case the current channel mode is speech, "Speech version (used)".

The "Old BSS to New BSS information" is used to pass Field Elements from the old BSS to the new BSS. The information in the "Old BSS to New BSS information" is transparent for the MSC. When the "Old BSS to New BSS information" is present in the HANOVER REQUIRED message the MSC shall pass it unchanged to any BSS associated to "Cell Identifier List (preferred)" when initiating the Handover resource allocation procedure. The old BSS must ensure that the information contained in the "Old BSS to New BSS information" information element is valid for all cells in the "Cell Identifier List (preferred)".

Section 3.2.1.9. gives coding details of the above message.

The "Cause" field indicates the reason for the HANOVER REQUIRED message e.g. "uplink quality poor" or "response to MSC invocation" in the case of traffic reasons indicated by the MSC.

The Cause value sent should be an indication which can be taken into account at the target BSS in future handover decision processes, e.g. to reduce oscillations between BSSs due to the fact that some information (on which the old BSS decided to initiate the handover) is not available at the target BSS (e.g. distance, traffic...).

If present the "Response Request" Information Element indicates, that the BSS requires an indication if the HANOVER REQUIRED message does not result in a HANOVER COMMAND message.

If the BSS wants to change the CIC due to a channel change, the BSS sends a HANOVER REQUIRED message with the cause "switch circuit pool" and the "circuit pool list" information element. The "circuit pool list" information element will allow the BSS to indicate to the MSC from which circuit pool or pools the new CIC should be chosen.

The "Cell Identifier List (preferred)" shall identify "n" preferred cells. The identified cells are given in order of preference. The algorithm by which the BSS produces this list is Operator dependent and is not addressed in this Technical Specification. The "n" number of preferred cells is a parameter set by O&M and shall range from 1 to 16. If "n" number of cells cannot be identified, then only as many as are available shall be encoded and sent (as specified in section 3.2.2.27). If a LSA information element has been received for a mobile subscriber indicating LSA only access, the "Cell Identifier List" shall contain only cells that are allowed for the subscriber. Exclusive access cells are included into the "Cell Identifier List (preferred)" only if they are allowed for the subscriber or if the connection is an emergency call.



It is mandatory for the BSS to be able to produce this "Cell Identifier List (preferred)". The sending of this list is controlled by the O&M parameter "n". It is mandatory for the MSC to be able to receive and interpret this Information Element.

The BSS may recommend to the MSC to allow queuing or not in the handover resource allocation procedure by indication in the "Queuing indicator" information element within the HANOVER REQUIRED message.

The old BSS may inform the new BSS of the presently configured channel in the Current Channel Type 1 information element and in the Current Channel type 2 Field Element. The information contained may be used by the new BSS (e.g. when building the radio interface HANOVER COMMAND message). Where discrepancies occur between the Current Channel Type 1 and the Current Channel Type 2 then the information in the Current Channel Type 2 shall take precedence if understood by the new BSS.

If, for this mobile station, the old BSS has received a Gb interface SUSPEND ACK PDU, then the old BSS shall include the GPRS Suspend information field in the Old BSS to New BSS IE in the HANOVER REQUIRED message.

If the old BSS received a GPRS Suspend information field in the Old BSS to New BSS IE in any preceding HANOVER REQUEST message received by the old BSS, then, the old BSS shall include the GPRS Suspend information field in the Old BSS to New BSS IE in the HANOVER REQUIRED message.

The old BSS may recommend to the new BSS to allow pre-emption or not allow pre-emption by sending the "prec" bit. The new BSS may take this information into account when performing the Handover resource allocation procedure.

The old BSS may inform the new BSS of radio information pertaining to the target cell in the "Target cell radio information" field element. The old BSS shall only send the "Target cell radio information" field element when it sends a single cell in the "Cell Identifier List (preferred)". This field element may be used by the new BSS (e.g. for radio channel selection).

NOTE: It is not recommended that this information element is included if more than one cell is sent in the "Cell Identifier List (preferred)".

The old BSS may inform the new BSS of the presently configured channel in the Current Channel Type 1 information element and in the Current Channel type 2 Field Element. The information contained may be used by the new BSS (e.g. when building the radio interface HANOVER COMMAND message). Where discrepancies occur between the Current Channel Type 1 and the Current Channel Type 2 then the information in the Current Channel Type 2 shall take precedence if understood by the new BSS.

If the present speech codec is a multi-rate speech codec, the old BSS may inform the new BSS of the current multi-rate codec configuration by including the MultiRate configuration information Field Element in the "Old BSS to New BSS information" information element. If the new BSS assigns a multi-rate speech codec this information may be used by the new BSS, to determine whether or not to include an MultiRate Configuration IE when building the radio interface HANOVER COMMAND message.

If the old BSS support dual transfer mode and the mobile station is in dual transfer mode in the old cell, the old BSS may provide information about the current resources by including the *Dual Transfer Mode information* field element in the *Old BSS to New BSS information* information element. The new BSS may use this information to determine the resources for the mobile station in the new cell (e.g. half rate traffic channel, adjacent resources available, EGPRS-capable resource).

The HANOVER REQUIRED message shall be updated and repeated by the BSS with a periodicity of T7 until:

- A HANOVER COMMAND message is received from the MSC, or;
- A RESET message is received, or;
- The reason for the original HANOVER REQUIRED message disappears e.g. the MS transmission improves, or;
- All communication is lost with the MS as defined in 3GPP TS 24.008 [6], and the transaction is abandoned, or;
- The transaction ends, e.g., call clearing.

### 3.1.5.2 Handover Resource allocation

This procedure has been defined to allow the MSC to request resources from a BSS in a manner similar to that used for the assignment case. However it does not result in the transmission of any messages over the radio interface, only in the reservation of the resource(s) identified at the BSS, which awaits access of a MS on the reserved channel(s). These reserved resources are then indicated back to the MSC.

In order to support this procedure the MSC sets up a BSSAP SCCP connection to the BSS. This connection is then used to support all BSSAP messages related to the dedicated resource(s).

In case of Voice Group Call, the MSC may reuse the existing Resource Controlling SCCP connection which has been previously set-up with the new BSS.

#### 3.1.5.2.1 Operation of the procedure

The correct operation of the handover resource allocation procedure is as follows:

The MSC sends a HANDOVER REQUEST message to the new BSS (note) from which it requires radio resources. This message contains details of the resource(s) required. If the MSC allocates the A interface circuits, and if the requested resource(s) is/are for speech or data the message also indicates the terrestrial resource that shall be used between the MSC and the BSS. The MSC should only ever ask for resources from the BSS that it knows are not totally incompatible with the nominated circuit. The type of channel(s) required can be different from the type of channel(s) in use, e.g. in the case of directed retry. The description of the resource(s) can either be a complete specification, or give the BSS some freedom in the selection (for instance channel rate selection, speech version selection etc.). The message may also specify the channel(s) in use, and, in case current channel mode is speech, the speech version used.

In case of Voice Group Call, the MSC need not to allocate a new A interface circuit. In such a case, the terrestrial resource which has been allocated during the VBS/VGCS assignment procedure is used as the new terrestrial resource.

On receipt of this message the new BSS shall choose suitable idle radio resources and, if the BSS allocates the A interface circuits and if needed, a terrestrial resource.

In case of Voice Group Call, the new BSS need not to allocate new radio resources. In such a case, the radio resource which has been allocated during the VBS/VGCS assignment procedure is used as the new radio resource.

The management of priority levels - relating to the Information Element "Priority" within the HANDOVER REQUEST message - is implementation dependent, under operator control.

If queuing is managed, new requests which cannot be served immediately are put in the queuing file according to the indicated priority levels.

(Refer to subclause 3.1.17 for Queuing Procedure.)

As a further operator option, the pre-emption indicators may (alone or along with the priority levels) be used to manage the pre-emption process, which may lead to the forced release or forced handover of lower priority connections.

However, the pre-emption indicators (refer to subclause 3.2.2.18), if given in the HANDOVER REQUEST, shall be treated on a per connection basis as follows:

- the last received "Pre-emption Vulnerability" indicator and priority levels shall prevail.
- if the "Pre-emption Capability" bit is set to 1, then this allocation request can trigger the running of the pre-emption procedure.
- if the "Pre-emption Recommendation" bit indicates that pre-emption is recommended by the old BSS, then the new BSS may obey the recommendation and act appropriately based on "Pre-emption Capability Indication" bit.
- if the "Pre-emption Recommendation" bit indicates that pre-emption is not recommended by the old BSS, then the new BSS may obey this recommendation and ignore the "Pre-emption Capability" bit if it is set to 1.
- if the "Pre-emption Recommendation" bit is not present then the pre-emption procedure can be run.
- if the "Pre-emption Capability" bit is set to 0, then this allocation request cannot trigger the pre-emption procedure.

- if the "Pre-emption Vulnerability" bit is set to 1, then this connection is vulnerable and shall be included in the pre-emption process or procedure and as such may be subject to forced release or forced handover.
- if the "Pre-emption Vulnerability" bit is set to 0, then this connection is not vulnerable to pre-emption and shall not be included in the pre-emption process and as such may not be subject to forced release or forced handover.
- if no Priority Information Element has been received, both "Pre-emption Capability" and "Pre-emption Vulnerability" bits shall be regarded as set to 0.

In the case where localised service area is supported, the MSC may inform the BSS as to which LSA identities that the mobile has preferences by sending the LSA INFORMATION message. The BSS stores this information and uses it when determining the target cell list for handover. The algorithm for determining the target cell list for handover is not defined further in this technical specification.

In the case where Intersystem handover to other RAT's is supported, the MSC may inform the target BSS, if preference for other radio access technologies (Service based handover) shall be applied to the MS connection. In such cases the MSC sets the Service Handover Information Element accordingly in the HANDOVER REQUEST message. The Service Handover information is stored in the BSS throughout the connection and is used in Handover evaluation process.

If a radio resource is available then this will be reflected back to the MSC in a HANDOVER REQUEST ACKNOWLEDGE message. If the MSC gave the BSS some freedom in resource type selection, the choices made by the BSS are indicated in the HANDOVER REQUEST ACKNOWLEDGE message. If the BSS allocates the A interface circuits and such a circuit is needed, the circuit allocated by the BSS is indicated in the HANDOVER ACKNOWLEDGE message. The HANDOVER REQUEST ACKNOWLEDGE message sent by the new BSS shall contain the radio interface message HANDOVER COMMAND within its "Layer 3 Information" Information Element. This "Layer 3 Information" (which is in fact the RR-Layer 3 HANDOVER COMMAND) is transferred by the controlling MSC to the old BSS using the BSSMAP message HANDOVER COMMAND also within the Information Element "Layer 3 Information" of that BSSMAP message. The old BSS then sends to the MS over the radio interface the RR-Layer 3 HANDOVER COMMAND message. Information about the appropriate new channels and a handover reference number chosen by the new BSS are contained in the HANDOVER COMMAND. Knowledge of the channel in use at the old BSS allows the new BSS to minimize the size of the HANDOVER COMMAND message (i.e. to decide whether the mode of the first channel IE need not be included in the HANDOVER COMMAND).

NOTE: The new BSS and the old BSS may be the same.

In the case of external handover the BSS, when localised service area is supported, will indicate the LSA identity of the target cell in the HANDOVER REQUEST ACKNOWLEDGE message if it corresponds to one of the LSA identities received in the HANDOVER REQUEST message.

When several circuit pools are present on the BSS MSC interface, and a circuit has been allocated by the HANDOVER REQUEST message, the "circuit pool" information field shall be included in the HANDOVER REQUEST ACKNOWLEDGE. The "circuit pool" field will indicate to the MSC the circuit pool of the CIC given in the HANDOVER REQUEST message.

The sending of the HANDOVER REQUEST ACKNOWLEDGE by the new BSS to the MSC ends the Handover Resource Allocation procedure. The Handover Execution procedure can now proceed and this is given in subclause 3.1.5.3.

The new BSS shall then take all necessary action to allow the MS to access the radio resource(s) that the new BSS has chosen, this is detailed in the 3GPP TS 45 series of Technical Specifications. If the radio resource(s) is a traffic channel or a group of traffic channels, then the new BSS shall at this point switch it through to the terrestrial resource indicated in the HANDOVER REQUEST message, and the necessary transcoding/rate adaption/encryption equipment enabled as detailed in 3GPP TS 24.008 [6].

The optimum procedure for switching through to the target cell at the MSC is not defined in these Technical Specifications.

### 3.1.5.2.2 Handover Resource Allocation Failure

The following failure conditions of this procedure may occur:

The BSS may not be able to use the terrestrial resource that the MSC has indicated in which case a HANOVER FAILURE message will be returned with the Cause value set to: "requested terrestrial resource unavailable".

The BSS may not be able to support the requested ciphering algorithm and in this case a HANOVER FAILURE message shall be returned to the MSC with the Cause value "Ciphering algorithm not supported".

If the requested channel type or resource (e.g. channel rate, speech version, etc.) indicated in the HANOVER REQUEST message is not available in the BSS, then a HANOVER FAILURE message shall be returned to the MSC. The appropriate failure cause will be included in the message (Cause value: "requested transcoding/rate adaptation unavailable" or "requested speech version unavailable").

The generation of the HANOVER FAILURE message terminates the procedure and allows all references in the new BSS to be released.

If, on reception of the HANOVER REQUEST by the BSS, the circuit pool implied by the CIC information element is incompatible with the channel type indicated (that is, the pool does not support any of the radio resources indicated by the channel type) a HANOVER FAILURE shall be returned to the MSC with the failure cause set to "circuit pool mismatch".

If, on reception of the HANOVER REQUEST by the BSS, the circuit pool implied by the CIC is compatible with the channel type indicated (that is, the pool supports at least one of the radio resource types indicated by the channel type), but the BSS still wishes to change the circuit pool, it sends a HANOVER FAILURE with the cause "switch circuit pool" and the "circuit pool list" information element.

The "circuit pool" information element, when present in the HANOVER FAILURE, indicates to the MSC which circuit pool the CIC indicated in the HANOVER REQUEST belongs to. This can be used by the MSC to correct its tables (CIC/circuit pool). The "circuit pool list" information element, when present in the HANOVER FAILURE, is used when the BSS wishes to indicate to the MSC its preferred circuit pools. The circuit pools in the "circuit pool list" information element shall be given in order of preference. In the case of a HANOVER FAILURE with the cause "circuit pool mismatch", the MSC may decide to block the circuit and to send an O & M notification.

Other possible cause values which may be returned with the HANOVER FAILURE message are: "equipment failure", "no radio resource available", "O&M intervention".

The MSC may not be able to use the terrestrial resource that the BSS has indicated. In this case, the procedure is nevertheless considered terminated successfully, and it is up to the MSC to correct the situation, e.g., by a circuit re-selection procedure.

Further actions in the MSC concerning handover depend upon the handover algorithm which is operator dependent. If an unrecognised Handover Failure cause value is received, the Class of the cause value should be used to determine the MSC's action.

### 3.1.5.2.3 Abnormal conditions

If after receipt of a HANOVER REQUEST message, the new BSS receives another HANOVER REQUEST message on the same SCCP connection, then the later message will be discarded.

If the BSS receives a HANOVER REQUEST allocating a terrestrial circuit which the BSS has marked as blocked by a previous blocking procedure, then a HANOVER FAILURE shall be returned to the MSC with the Cause set to "requested terrestrial resource unavailable". A single global BLOCK message (not repeated and not guarded by timer T1) shall be sent for that concerned terrestrial circuit.

If the BSS receives a HANOVER REQUEST message indicating a target cell which is not controlled by the BSS, then a HANOVER FAILURE message shall be returned to the MSC with the cause set to "invalid cell".

### 3.1.5.3 Handover execution

Handover execution in the context of the BSS/MS interface is the process whereby an MSC instructs an MS to tune to a new dedicated radio resource or to a group of radio resources, which may be on a different cell.

### 3.1.5.3.1 Operation of the procedure

The correct operation of the procedure is as follows:

The BSSMAP HANDOVER COMMAND message is generated by the MSC and transmitted over the BSSAP connection to the old BSS which is currently supporting the concerned MS. At the old BSS timer T8 is started on the receipt of the BSSMAP HANDOVER COMMAND message. A radio interface HANDOVER COMMAND message is then sent by the old BSS, to the concerned MS. The message contains a handover reference number, previously allocated by the new BSS.

The BSSMAP HANDOVER COMMAND message generated by the MSC may optionally contain a Cell Identifier IE which indicates to the old BSS the target cell identity to which the handover is to be performed. In case of failure, this information allows the old BSS to know on which cell the handover failed.

When the MS accesses the radio resource(s) of the new BSS with a HANDOVER ACCESS burst which contains the received handover reference number then:

The new BSS checks the handover reference number to ensure that it is the same as expected, and hence that there is a high probability that the correct MS has been captured (if the handover reference is not as expected then the new BSS shall wait for an access by the correct MS);

If the handover reference number is as expected, the new BSS shall send a HANDOVER DETECT message to the MSC;

When the MS is successfully in communication with the network, i.e. the RR message HANDOVER COMPLETE has been received from the MS, then the new BSS will immediately send a BSSMAP message HANDOVER COMPLETE to the MSC and terminate the procedure.

In the case where the new BSS hands the MS to a Group call channel, the BSS shall send a CLEAR REQUEST with cause "Joined group call channel" directly after having sent the HANDOVER COMPLETE message.

In the case of point to point calls the MSC shall terminate the procedure with the old BSS by sending a CLEAR COMMAND with cause "Handover successful".

In the case of a handover from a Group call channel the MSC shall terminate the procedure by sending a HANDOVER SUCCEEDED message. On receipt of a HANDOVER SUCCEEDED from the MSC, the old BSS shall stop timer T8.

The old dedicated radio resource(s) and connected terrestrial resource shall remain assigned until either the MSC instructs the old BSS to release the resource(s) by a CLEAR COMMAND or a reset occurs.

After the completion of the handover procedure, until the connection is released or the MSC performs an assignment, any dedicated resource assigned to the mobile station, e.g. at internal handover, must be in accordance with the description in the HANDOVER REQUEST message.

If either:

a CLEAR COMMAND is received from the MSC;

or

a reset is received from the MSC,

before a MS with the correct handover reference accesses the new BSS then the radio resources shall be released and the terrestrial resources marked as idle

The relevant radio interface layer 3 procedures are described in 3GPP TS 24.008 [6].

The MSC always terminates this procedure by use of a clear sequence as follows:

The MSC sends a CLEAR COMMAND to the old BSS. On receipt of a CLEAR COMMAND from the MSC the old BSS shall stop timer T8 and release all involved resources that were allocated to the MS that had been handed over and returns a CLEAR COMPLETE message to the MSC.

On receipt of the CLEAR COMPLETE, the MSC shall initiate the release of the SCCP connection to the old BSS and thereby terminate association with the old BSS for this process.

### 3.1.5.3.2 Handover Failure

If a HANOVER FAILURE radio interface message is received from the MS on the old (main) channel by the old BSS, the old BSS shall then send to the MSC the BSSMAP message HANOVER FAILURE. If the radio interface HANOVER FAILURE message is the result of the MS returning to the old BSS after failing to establish on the new BSS, then the cause value "radio interface failure, reversion to old channel" shall be included in the BSSMAP message HANOVER FAILURE. Furthermore, it is recommended that the air interface RR cause be included as well in this message.

If the MSC receives the BSSMAP HANOVER FAILURE message from the old BSS (with any cause value) and if the target channel is not a Group Call Channel, the handover procedure at the target new BSS is then terminated by the MSC using a clear sequence as follows:

The MSC sends a CLEAR COMMAND cause "Radio interface failure, reversion to old channel" to the new BSS. On receipt of a CLEAR COMMAND from the MSC the new BSS shall release all involved resources that were allocated during the handover resource allocation procedure and returns a CLEAR COMPLETE message to the MSC.

On receipt of the CLEAR COMPLETE, the MSC shall initiate the release of the SCCP connection to the new BSS and thereby terminate association with the new BSS for this process.

The call between the MS and the old BSS and between the old BSS and the MSC shall continue as if there had been no handover attempt.

Further actions in the MSC concerning handover depends on the handover algorithm which is operator dependent.

In the case of a talker on a group call channel the MS may release the uplink whilst the handover is being performed, in this case the old BSS shall cancel the handover internally, the MSC should cancel the handover and initiate the release of the A interface resources allocated in the new BSS.

### 3.1.5.3.3 Abnormal Conditions

Whilst the handover execution procedure is in operation, any other messages received at the old BSS relating to this connection and concerning assignment, handover, or cipher mode control should be discarded.

Whilst the handover execution procedure is in operation the old BSS should not attempt to invoke any other procedure related to this call e.g. handover required indication.

If at the old BSS a CLEAR COMMAND message from the MSC or a HANOVER FAILURE message from the MS is not received before the expiry of timer T8 then the old BSS shall release the dedicated radio resources. A BSSMAP message CLEAR REQUEST is also sent to the MSC with a cause "Radio Interface Message Failure". The terrestrial resource in the old BSS shall remain assigned until a CLEAR COMMAND is received from the MSC, at which point the old BSS shall mark the terrestrial resources as IDLE and return a CLEAR COMPLETE message to the MSC. The MSC shall subsequently release the SCCP connection to the old BSS and thereby terminate association with the old BSS for this process.

In the case of a handover from a Group call channel, if at the old BSS a CLEAR COMMAND or HANOVER SUCCEDED message from the MSC or a HANOVER FAILURE message from the MS is not received before the expiry of timer T8 then the old BSS shall release the uplink and send a UPLINK RELEASE INDICATION to the MSC.

The MSC shall also initiate release of the resources allocated by the new BSS during the handover resource allocation procedure by sending a CLEAR COMMAND to the new BSS. The new BSS shall release all the resources that were assigned for that aborted handover and return a CLEAR COMPLETE to the MSC. The MSC shall subsequently release the SCCP connection to the new BSS and thereby terminate association with the new BSS for this process.

### 3.1.5a Handover from GSM to another System

Using this protocol the BSS should support handover transitions to other systems from an SDCCH, a Full Rate TCH a Half Rate TCH and Multiple Full Rate TCHs.

There are three procedures which are used for inter-system handover. They are:

- Inter-System Handover Required Indication;
- Inter-System Handover Resource Allocation;
- Inter-System Handover Execution.

The first and part of the third of these procedures are specified in this specification. The second and other part of the third procedures are specified in the relevant specification of the target system.

For any HANOVER REQUIRED message at most one HANOVER COMMAND message may be sent.

In the case of inter-MSC handover the term "the MSC" in this subclause is taken to mean the relevant MSC in the handover operation.

The inter-system handover procedures are specified in the following subclauses.

All messages concerned with inter-system handover are sent using the connection oriented mode of the SCCP.

#### 3.1.5a.1 Generation of the HANOVER REQUIRED message for intersystem handover

The HANOVER REQUIRED message contains the following information elements:

- Message Type;
- Cause;
- Cell Identifier List

In case of Inter System Handover it contains the information element: "Source RNC to target RNC transparent information".

The "Source RNC to target RNC transparent information" is used to pass information from the old BSS to the target RNC. The information in the "Source RNC to target RNC transparent information" is transparent for the MSC. At presence of the "Source RNC to target RNC transparent information" in the HANOVER REQUIRED message the MSC shall pass it unchanged to the Target RNC when initiating the Handover resource allocation procedure. The Target RNC is identified by the Target ID information contained in the Cell Identifier List IE. The Target ID information is structured routing information as required by the core network [31]. The information contained in the "Source RNC to target RNC transparent information" information element is coded as required by the target system.

Subclause 3.2.1.9. gives coding details of the above message.

The "Cause" field indicates the reason for the HANOVER REQUIRED message e.g. "downlink quality".

The Cell Identification Discriminator field within the Cell Identifier List IE in the HANOVER REQUIRED message can be used to deduce that this is an intersystem handover.

If present the "Response Request" Information Element indicates, that the BSS requires an indication if the HANOVER REQUIRED message does not result in a HANOVER COMMAND message.

The Cell Identifier List IE contains the RNC-ID (and additionally the LAC or LAC and PLMN-ID depending on the configuration of the network) of the target for intersystem handover

It is mandatory for BSS to produce the RNC-ID. It is mandatory for the MSC to be able to receive and interpret this Information Element for routing purpose.

The BSS may recommend to the target RNC to allow pre-emption or not allow pre-emption by sending the "prec" bit. The target RNC may take this information into account when performing the Handover resource allocation procedure.

The HANDOVER REQUIRED message shall be updated and repeated by the BSS with a periodicity of T7 until:

- A HANDOVER COMMAND message is received from the MSC, or;
- A RESET message is received, or;
- The reason for the original HANDOVER REQUIRED message disappears e.g. the MS transmission improves, or;
- All communication is lost with the MS as defined in 3GPP TS 44.018 [32], and the transaction is abandoned, or;
- The transaction ends, e.g., call clearing.

### 3.1.5a.2 Inter-System Handover Resource Allocation Failure

If the MSC receives a HANDOVER REQUIRED message indicating an unknown target RNC then the MSC shall send a HANDOVER REQUIRED REJECT message to the old BSS with a cause value indicating 'invalid cell'

If the MSC or the target system is unable to allocate resources for the handover attempt, the MSC shall send a HANDOVER REQUIRED REJECT message to the old BSS with an appropriate cause value.

### 3.1.5a.3 Intersystem handover Execution

The correct operation of the procedure is as follows:

The BSSMAP HANDOVER COMMAND message is generated by the MSC and transmitted over the BSSAP connection to the old BSS which is currently supporting the concerned MS. At the old BSS timer T8 is started on the receipt of the BSSMAP HANDOVER COMMAND message which contains the Layer 3 Information IE including radio interface handover command message. A radio interface INTER SYSTEM HANDOVER COMMAND message is then sent by the old BSS, to the concerned MS.

When the MS accesses the radio resource(s) of the new RNC then:

the new RNC shall cause a Handover Detect indication to be sent to the MSC;

When the MS is successfully in communication with the network, then the new RNC shall cause a Handover Complete indication to be sent to the MSC and terminate the procedure.

The relevant radio interface layer 3 procedures are described in 3GPP TS 25.331 [33] and 3GPP TS 44.018 [32].

The MSC always terminates this procedure by use of a clear sequence as follows:

The MSC sends a CLEAR COMMAND to the old BSS. On receipt of a CLEAR COMMAND from the MSC the old BSS shall stop timer T8 and release all involved resources that were allocated to the MS that had been handed over and returns a CLEAR COMPLETE message to the MSC.

On receipt of the CLEAR COMPLETE, the MSC shall initiate the release of the SCCP connection to the old BSS and thereby terminate association with the old BSS for this process.

### 3.1.5a.4 Inter System Handover Failure

If a HANDOVER FAILURE radio interface message is received from the MS on the old (main) channel by the old BSS, the old BSS shall then send to the MSC the BSSMAP message HANDOVER FAILURE. If the radio interface HANDOVER FAILURE message is the result of the MS returning to the old BSS after failing to establish on the new BSS, then the cause value "radio interface failure, reversion to old channel" shall be included in the BSSMAP message HANDOVER FAILURE. Furthermore, it is recommended that the air interface RR cause be included as well in this message.

If the MSC receives the BSSMAP HANDOVER FAILURE message from the old BSS (with any cause value, the handover procedure at the target is then terminated by the MSC.

The call between the MS and the old BSS and between the old BSS and the MSC shall continue as if there had been no handover attempt.



### 3.1.5a.5 Abnormal Conditions

Whilst the handover execution procedure is in operation, any other messages received at the old BSS relating to this connection and concerning assignment, handover, or cipher mode control should be discarded.

Whilst the handover execution procedure is in operation the old BSS should not attempt to invoke any other procedure related to this call e.g. handover required indication.

If at the old BSS a CLEAR COMMAND message from the MSC or a HANDOVER FAILURE message from the MS is not received before the expiry of timer T8 then the old BSS shall release the dedicated radio resources. A BSSMAP message CLEAR REQUEST is also sent to the MSC with a cause "Radio Interface Message Failure". The terrestrial resource in the old BSS shall remain assigned until a CLEAR COMMAND is received from the MSC, at which point the old BSS shall mark the terrestrial resources as IDLE and return a CLEAR COMPLETE message to the MSC. The MSC shall subsequently release the SCCP connection to the old BSS and thereby terminate association with the old BSS for this process.

In the case of a handover from a Group call channel, if at the old BSS a CLEAR COMMAND or HANDOVER SUCCEEDED message from the MSC or a HANDOVER FAILURE message from the MS is not received before the expiry of timer T8 then the old BSS shall release the uplink and send a UPLINK RELEASE INDICATION to the MSC.

The MSC shall also initiate release of the resources allocated by the new BSS during the handover resource allocation procedure by sending a CLEAR COMMAND to the new BSS. The new BSS shall release all the resources that were assigned for that aborted handover and return a CLEAR COMPLETE to the MSC. The MSC shall subsequently release the SCCP connection to the new BSS and thereby terminate association with the new BSS for this process.

### 3.1.6 Internal Intra-Cell Handover Procedure

The definition of internal intra cell handover is given in clause 5.

It is optional that a BSS support internal intra-cell handover. However if it is supported, it should be as follows:

It should be possible to inhibit internal intra-cell handover at an BSS that supports it by operation and maintenance command.

Internal intra-cell handover occurs between channels on the same cell. It is decided and executed autonomously by the BSS, so that no message is generated at the BSS-MSC interface, until the completion of the handover execution, when the BSS sends a HANDOVER PERFORMED message over the SCCP and terrestrial resources that are presently assigned to that call. Changes in type of resources (for instance channel rate change, speech version change, ciphering algorithm change) are indicated in the HANDOVER PERFORMED message.

The decision process in the BSS is based on the internally available radio and resource parameters taking into account the previously received information from the MSC in the ASSIGNMENT REQUEST or HANDOVER REQUEST.

The relevant radio interface layer 3 procedures (dedicated channel assignment) are described in 3GPP TS 24.008 [6].

In the case of group calls the BSS may perform an intra-cell handover for a talker from a dedicated channel to a group call channel, in this case the HANDOVER PERFORMED message is sent by the BSS over the SCCP connection that was previously assigned to the talker, followed by a CLEAR REQUEST with the cause "Joined group call channel", the MSC shall release the dedicated A interface resources.

In the case of group calls the BSS may perform an Intra-cell handover for a talker from a Group call channel to a dedicated channel, in this case the BSS performs external handover.

### 3.1.7 Internal Inter-Cell Handover Procedure

The definition of internal inter-cell handover is given in clause 5.

It should be possible to inhibit internal inter-cell handover at a BSS that supports it by operation and maintenance command.

Multi cell BSSs would normally be expected to support internal inter-cell handover, however it is optional that they do so. However if it is supported, it should be as follows:

Internal inter-cell handover occurs between channels pertaining to different cells of the same BSS. It is decided and executed autonomously by the BSS, so that no message is generated at the BSS-MSC interface, until the completion of the handover execution, when the BSS sends a HANOVER PERFORMED message over the SCCP and terrestrial resources that are presently assigned to that call. Changes in type of resources (for instance channel rate change, speech version change, ciphering algorithm change) are indicated in the HANOVER PERFORMED message.

A special case of internal handover occurs when the handover is triggered by the assignment procedure, e.g. directed retry. In this case the HANOVER PERFORMED message need not be sent as the equivalent response is provided by the ASSIGNMENT COMPLETE message.

The decision process in the BSS is based on the internally available radio and resource parameters taking into account the previously received information from the MSC in the ASSIGNMENT REQUEST or HANOVER REQUEST.

The relevant radio interface layer 3 procedures (for handover) are described in 3GPP TS 24.008 [6].

Internal inter-cell handover for group calls may be performed from either dedicated to dedicated channels, or dedicated to group call channels, or group call to group call channels.

In the case of group calls, the BSS may perform an internal inter-cell handover for a talker from a dedicated channel to a Group call channel, in this case the HANOVER PERFORMED message is sent by the BSS over the SCCP connection that was previously assigned to the talker. The BSS will send a CLEAR REQUEST with the cause "Joined group call channel".

In the case of group calls, the BSS may perform an internal inter-cell handover for a talker from a group call channel to a Group call channel, in this case the HANOVER PERFORMED message is sent by the BSS over the SCCP connection that was previously assigned to the talker.

In the case of internal inter-cell handover the BSS, when localised service area is supported, will indicate the LSA identity of the target cell in the HANOVER PERFORMED message if it corresponds to one of the LSA identities received in the latest LSA INFORMATION or the HANOVER REQUEST messages.

### 3.1.8 Handover Candidate Enquiry

The purpose of this procedure is to allow the MSC to ascertain if it is possible to handover any MSs that are currently being served by a particular cell to another nominated cell. The procedure uses both global and dedicated resource messages, and is relevant to an individual cell.

The algorithm in which a MSC decides on starting a handover enquiry procedure is operator dependent.

#### 3.1.8.1 Successful Operation

The procedure operates as follows:

The MSC sends a HANOVER CANDIDATE ENQUIRE message to a BSS. The message indicates that the MSC wishes the BSS to identify handover candidates in a particular cell, that can be handed over to other nominated cells. The maximum number of candidates is also indicated to the BSS.

For each selected MS candidate the BSS will send to MSC a single, once only, HANOVER REQUIRED message (not guarded by timer T7), over each of the appropriate SCCP connections. If the BSS was already generating HANOVER REQUIRED messages for a selected MS then the BSS will continue to do so. However the Cause IE of the next HANOVER REQUIRED message (at the expiry of timer T7) will be set to "Response to MSC invocation" to indicate that the message is generated in response to a HANOVER CANDIDATE ENQUIRE message. But as this HANOVER REQUIRED was already being generated before the handover enquiry procedure was started, that HANOVER REQUIRED would be guarded by timer T7. So in the instance of next expiry of timer T7, the BSS shall continue sending HANOVER REQUIRED message but the Cause IE value shall revert back to the original Cause IE value.

When the last HANOVER REQUIRED message has been sent for all the selected MS candidates, the BSS returns to the MSC a HANOVER CANDIDATE RESPONSE message giving the number of candidates identified, and terminating the handover enquiry procedure.

Only one handover enquiry procedure may be invoked on any given cell at any one time.

### 3.1.8.2 Abnormal conditions

If at the BSS a HANOVER CANDIDATE ENQUIRE message is received when a handover enquiry procedure has already been invoked then the new HANOVER CANDIDATE ENQUIRE message shall be discarded.

## 3.1.9 Release of Radio Resource And Terrestrial Resource

### 3.1.9.1 Release Due To Transaction Completion

The release of assigned radio resources at the end of a transaction will take place as follows:

Release negotiation will take place directly between the MS and MSC using transparent messages via the DTAP in the BSS (see 3GPP TS 24.008 [6]). The MSC will then send a BSSMAP CLEAR COMMAND, indicating that the radio resource(s) should be released. After the BSSMAP CLEAR COMMAND has been sent, the MSC shall not send further BSSAP connection oriented messages on this particular connection, except CLEAR COMMAND.

If the BSS allocates the A interface circuits, the MSC shall release the circuit allocated to the connection, if any, before sending the CLEAR COMMAND.

When the BSS receives the CLEAR COMMAND:

the guard timer defined in 3GPP TS 24.008 [6] is started and clearing on the radio interface initiated.

the BSS marks any assigned terrestrial resources as idle and returns a CLEAR COMPLETE message to the MSC. (The BSS need not wait for the radio channel release to be completed or for the guard timer to expire before returning the CLEAR COMPLETE message.)

If the MSC allocates A interface circuits, on receipt of CLEAR COMPLETE, the MSC releases any assigned terrestrial resources.

### 3.1.9.2 Release due to BSS generated reason

If a radio channel release is required because of a BSS generated reason (e.g. "O and M intervention", "equipment failure") then, the BSS shall generate a CLEAR REQUEST message towards the MSC. This message shall include a Cause Information Element, indicating the reason for the failure.

If transmission from the MS is lost then a CLEAR REQUEST message shall be sent to the MSC.

On receipt of a CLEAR REQUEST the MSC shall initiate the release, as defined above, by sending a CLEAR COMMAND message. On receipt of this message the BSS shall, if the resources are not already internally released, release the resources in the normal way. The procedure is always terminated with a CLEAR COMPLETE to the MSC.

In the case of a group call talker the BSS may move the mobile on to a group call channel, in this case the BSS shall initiate a release of A interface resources by sending a CLEAR REQUEST with the cause "Joined group call channel". The MSC in its turn shall release the dedicated resources associated with the talker.

If BSS sends a CLEAR REQUEST with the cause different than "Joined group call channel" for resources associated with the uplink, then the MSC shall assume uplink indicated as released.

### 3.1.9.3 Release due to successful handover

If a radio channel release is required because of a handover being successfully completed on another BSS, then the resources at the old BSS are released by the MSC using the clearing sequence with a Cause value; "handover successful".

In the case of handover of a group call talker from a group call channel the MSC shall send a HANOVER SUCCEDED message to the old BSS.

#### 3.1.9.4 Release due to uplink release

If a talker on dedicated connection releases its uplink the MSC is informed by an UPLINK RELEASE INDICATION message, then the resources at the BSS are released by the MSC using the clearing sequence. BSS is allowed to release radio resources before the MSC initiate the clearing procedure.

#### 3.1.10 Paging

PAGING messages for all MSs shall be sent via the BSSMAP as a connectionless message. These will include the IMSI of the MS to allow derivation of the paging population number; they may also include an indication of which combination of channels will be needed for the subsequent transaction related to the paging. This type of PAGING message will then be stored and a corresponding radio interface paging message transmitted over the radio interface at the appropriate time.

It should be noted that each PAGING message on the MSC-BSS interface relates to only one MS and therefore the BSS has to pack the pages into the relevant 3GPP TS 24.008 [6] radio interface paging message.

If a radio interface PAGING RESPONSE message is received then the relevant connection is set up towards the MSC as described in 3GPP TS 48.002 [17] and the radio interface PAGING RESPONSE message is passed to the MSC in a COMPLETE LAYER 3 INFORMATION message.

A single PAGING message across the MSC to BSS interface contains information on the cells in which the page shall be broadcast.

#### 3.1.11 Trace Invocation

The purpose of the trace invocation procedure is to inform the receiving entity that it should begin producing a trace record on this particular transaction.

The trace is invoked either by the MSC sending a MSC INVOKE TRACE message to the BSS or by the BSS sending a BSS INVOKE TRACE message.

The events and parameters to be recorded are indicated in the "Trace type" information element.

A "Forwarding indicator" element may be used in the BSS INVOKE TRACE to indicate if the trace is to be continued after handover to another BSS. If thus indicated, The MSC should forward the BSS INVOKE TRACE to the BSS-B and also store it to send to any subsequent BSS during the lifetime of the call.

The remaining elements, when received, are to be passed transparently to the OMC receiving the trace record.

The element "OMCId", if present, indicates the OMC to which the record is destined.

In sending the BSS INVOKE TRACE message, the BSS may allocate and include a "BSS transaction reference". Similarly in the MSC INVOKE TRACE message, the MSC may allocate and include an "MSC transaction reference" (typically a call reference). The transaction reference is contained in the information element "TransactionId".

The message includes a trace reference which is allocated by the entity which triggered the trace.

The element "TriggerId", if present, indicates the entity which triggered the trace.

The trace reference, triggerId and transactionId Information Elements are used to tag the trace record to allow simpler construction of the total record by the entity which combines trace records.

The messages are not acknowledged and are sent as a connection oriented message on the connection on which a trace is required.

#### 3.1.12 Flow Control

These procedures are defined to give some degree of flow control. At the BSS processor overload and CCCH scheduler overload are catered for, and at the MSC processor overload is catered for.

### 3.1.12.1 Philosophy

The philosophy used is to stem the traffic at source with known effect on the service. The algorithm used is:

- On receipt of the first OVERLOAD message or signalling point congested information, the traffic is reduced by one step. At the same time, timers T5 (T17) and T6 (T18) are started. During T5 (T17) all received overload messages or signalling point congested information are ignored in order not to reduce the traffic too rapidly. Reception of an OVERLOAD message or signalling point congested information after expiry of T5 (T17) but still during T6 (T18) , will decrease the traffic load by one more step, and restart T5 (T17) and T6 (T18).
- This step by step reduction of traffic is continued until maximum reduction is obtained by arriving at the last step. If T6 (T18) expires (i.e. no OVERLOAD message or signalling point congested information is received during T6 (T18)) the traffic will be increased by one step and T6 (T18) will be started, unless full load has been resumed.

NOTE: Timers T5 and T6 are running in the MSC whilst Timers T17 and T18 are running in the BSS.

- The number of steps and the method of reducing the load is considered to be an implementation specific function.

There may be other traffic control mechanisms from O and M activities occurring simultaneously.

### 3.1.12.2 Processor Overload at the MSC

The MSC can indicate to the BSS that it is in a congested state by sending an OVERLOAD message. This is sent as a connectionless global message.

At the BSS receipt of this message causes the reduction of random access traffic using the method described in subclause 3.1.12.1.

For example, the amount of random access traffic could be reduced by using the access control class in the system information message of 3GPP TS 24.008 [6].

### 3.1.12.3 Processor/CCCH overload at the BSS

If the CCCH scheduler at the BSS is overloaded (queue passed a predefined threshold) then the BSS sends an OVERLOAD message to the MSC with the appropriate cause (Cause value: "CCCH overload") and indicating the cell in question.

If the BSS processing is overloaded then the BSS sends an OVERLOAD message with the Cause value: "processor overload".

The MSC originated traffic is reduced in accordance with the method described in subclause 3.1.12.1.

### 3.1.12.4 Message throughput congestion

If the lower layers of the protocol become congested then it is assumed that the MTP congestion indication will take place (see 3GPP TS 48.002 [17]) and the source of the traffic will receive primitives from the transport protocols resulting in it reducing the generated load.

A suitable method to achieve this reduction could be based on that given in subclause 3.1.12.1.

## 3.1.13 Classmark Handling Procedures

### 3.1.13.1 Classmark request procedure

The purpose of this procedure is to allow the MSC to trigger a classmark updating procedure. This is done by sending a CLASSMARK REQUEST message to the BSS on the appropriate SCCP connection. When receiving this message the BSS shall initiate the appropriate actions on the radio path.

### 3.1.13.2 Classmark updating procedure

The purpose of the classmark updating procedure is to inform the receiving entity about classmark information received from the MS.

At any point when an SCCP connection has been established for BSSAP messages, the BSS must be able to send to the MSC a CLASSMARK UPDATE message if a classmark update is received from the MS. This message contains information on several transmission parameters relevant to the MS in communication with the network.

If the MSC has already initiated a handover for the concerned MS by sending a HANDOVER REQUEST message when the CLASSMARK UPDATE message is received, the MSC shall send a CLASSMARK UPDATE message to the target BSS when the MS is successfully in communication with the network on the new (main) channel. If this CLASSMARK UPDATE message is received in the target BSS after a new classmark has been received from the Mobile Station the CLASSMARK UPDATE message from the MSC shall be ignored.

This message is sent as a BSSAP message over the appropriate SCCP connection.

This procedure will be used where the power class of the MS changes or if the network requests the MS to send the classmark information whilst the MS has one or more dedicated resources.

The procedure will also be used to send classmark information to the MSC if the MS immediately after initial L3 message sends additional classmark information. In this case the BSS may as an option suppress or delay the sending of the CLASSMARK UPDATE message to the MSC.

## 3.1.14 Cipher Mode Control

### 3.1.14.1 Successful Operation

The cipher mode control procedure allows the MSC to pass cipher mode information to the BSS to select and load the user data and signalling encryption device with the appropriate key.

This is achieved by sending the BSS a CIPHER MODE COMMAND message. Receipt of the message at the BSS will cause the generation of a radio interface CIPHERING MODE COMMAND message and, if applicable, invoke the encryption device and start stream ciphering as described in 3GPP TS 24.008 [6] and 3GPP TS 43.020 [39].

If within the CIPHER MODE COMMAND, the signalling element "Cipher response mode" is present and indicates "IMEI must be included by the Mobile Station", then the BSS shall request in the radio interface message CIPHERING MODE COMMAND the Mobile Station to include its IMEI in the radio interface CIPHERING MODE COMPLETE message (see 3GPP TS 24.008 [6], subclause 'Ciphering mode setting initiation').

In the CIPHER MODE COMMAND the MSC specifies which of the ciphering algorithms may be used by the BSS. The BSS then selects an appropriate algorithm, taking into account the MS ciphering capabilities. The CIPHER MODE COMPLETE message returned to the MSC indicates the chosen ciphering algorithm. The set of permitted ciphering algorithms specified in the CIPHER MODE COMMAND shall remain applicable for subsequent Assignments and Intra-BSS Handovers.

The CIPHER MODE COMMAND and CIPHER MODE COMPLETE messages are sent as connection oriented messages via the appropriate SCCP connection.

Receipt of the radio interface CIPHERING MODE COMPLETE message (or other correctly deciphered layer 2 frame) from the radio interface is used internally within the BSS to achieve radio interface ciphering synchronisation (see 3GPP TS 24.008 [6]). When the BSS receives the radio interface CIPHERING MODE COMPLETE from the MS a CIPHER MODE COMPLETE message is returned to the MSC. If the CIPHERING MODE COMPLETE message received on the radio interface contained more than two octets, then the BSS shall include in the BSSMAP CIPHER MODE COMPLETE message a "Layer 3 message contents" signalling element containing octets 3 up to n (where n is the length of that CIPHERING MODE COMPLETE radio interface message) of that radio interface CIPHERING MODE COMPLETE message.

### 3.1.14.2 Abnormal Conditions

If the BSS is unable to support the ciphering algorithm specified in the CIPHER MODE COMMAND message then it shall return a CIPHER MODE REJECT message with Cause value "Ciphering algorithm not supported". A CIPHER

MODE REJECT message shall also be returned if the MSC requests a change of ciphering algorithm when ciphering is already active.

### 3.1.15 General SCCP Abnormal Conditions

If a user-out-of-service information or signalling-point-inaccessible information is received by the BSSAP or BSSOMAP no new attempt to establish SCCP connections towards the affected point code will be started until the corresponding user-in-service information or signalling-point-accessible information is received.

When a user-out-of-service information or signalling-point-inaccessible is received by the BSS an optional timer may be started. When the timer expires all the SCCP connections towards the affected point code will be released. When the user-in-service or signalling-point-accessible is received, the timer is stopped.

If for any reason an SCCP connection is released, the optional timer expires or a connection refusal is received while any of the BSSAP procedures are being performed or while a dedicated resource is still allocated the following actions are taken:

#### At BSS:

The radio resources associated with the SCCP connection are cleared by an appropriate radio procedure.

Any BSS procedure relating to that connection is abandoned.

The resources allocated to the call associated to the connection are released.

#### At MSC:

The call associated with the SCCP connection is cleared as soon as possible.

At the BSS, communication over assigned radio channels shall be assumed to be continuing until either the SCCP connection is lost, a clearing sequence is received, or no signal is received from an MS for longer than the guard time defined in 3GPP TS 24.008 [6]. If the BSS recognises that a call has terminated then a CLEAR REQUEST message should be generated.

If a 2Mbit/s system fails and one of the standard alarms is received, no action is taken at the BSS on the calls associated with the traffic channels involved.

At the MSC, calls or VGCS talker dedicated connection and associated uplink or resource controlling connection should be cleared if either subscriber clears, or if the BSS sends a CLEAR REQUEST message. Clearing of affected calls by the MSC may take place after loss of the traffic channels for a period defined by the operator.

For the procedures controlled by the MSC, and in particular procedures where the MSC sends a request for resources at the BSS and waits for an acknowledge, the implementation in the MSC must provide means for avoiding deadlock situations at the BSS as e.g. hanging resources.

### 3.1.16 Initial MS message

When the SCCP connection establishment is performed by the BSS, the radio interface initial L3 message received from the MS (piggybacked on the SABM frame) is processed as follows:

The BSS shall analyse the protocol discriminator of the message.

If the BSS does not support the protocol, reactions of the BSS are specified in 3GPP TS 24.008 [6]. If the BSS supports the protocol, it shall analyse the message to a level which allows the extraction by the BSS of the Classmark information. However, except for the NOTIFICATION RESPONSE, the entire radio interface initial L3 message (e.g. CM SERVICE REQUEST, PAGING RESPONSE, CM REESTABLISHMENT REQUEST, LOCATION UPDATING REQUEST, IMSI DETACH, IMMEDIATE SETUP) is also passed to the MSC, using a COMPLETE LAYER 3 INFORMATION message. The BSS does not analyse the contents of the initial layer 3 message, other than the Classmark information.

The BSS may also give the MSC a description of the channel on which the initial layer 3 message was received.

### 3.1.17 Queuing Indication

The purpose of the QUEUING INDICATION message is to inform the MSC about a delay in the allocation of the necessary dedicated radio resources. The procedure is only relevant if the system is using a queuing procedure for traffic channels in the BSS, (subclause 3.1.17.1) and/or for handover of traffic channels (subclause 3.1.17.2)

#### 3.1.17.1 Operation of the procedure in case of assignment procedure

After the ASSIGNMENT REQUEST message without having the necessary TCH available the ASSIGNMENT REQUEST message shall be put into a queue; the QUEUING INDICATION message shall be returned to the MSC and the timer T11 shall be started. The timer value T11 specifies the maximum queuing delay and is determined by the operator.

The procedure shall be terminated with a successful or unsuccessful assignment of the required traffic channel(s) by sending an ASSIGNMENT COMPLETE or an ASSIGNMENT FAILURE message, respectively, to the MSC.

If the timer T11 expires the ASSIGNMENT REQUEST message shall be removed from the queue and a CLEAR REQUEST message shall be sent to the MSC, with the Cause "no radio resource available".

#### 3.1.17.2 Operation of the procedure in case of hand-over resource allocation procedure

After the HANOVER REQUEST message without having the necessary TCH available the HANOVER REQUEST shall be put into a queue; the QUEUING INDICATION message shall be returned to the MSC and the timer Tqho shall be started. The timer value Tqho specifies the maximum queuing delay and is determined by the operator.

The procedure shall be terminated with a successful or unsuccessful reservation of the required traffic channel(s) by sending a HANOVER REQUEST ACKNOWLEDGE or a HANOVER FAILURE message, respectively, to the MSC.

If the timer Tqho expires the HANOVER REQUEST shall be removed from the queue and a HANOVER FAILURE message shall be sent to the MSC with the Cause value "no radio resource available".

### 3.1.18 Data Link Control SAPI not Equal to "0"

The radio interface can support data links with the SAPI not equal to "0".

#### 3.1.18.1 Data link set up across the radio interface

This subclause deals with the impact of data link establishment (SAPI not equal to "0") on the MSC to BSS interface.

##### 3.1.18.1.1 MS to MSC direction

In the MS to MSC direction the receipt of a layer 3 message via a data link where SAPI does not equal "0" at the BSS will be transferred to the MSC as a DTAP message with the DLCI (Data Link Connection Identification) octet set appropriately.

##### 3.1.18.1.2 MSC to MS Direction

Receipt of a layer 3 (DTAP) message from the MSC with the SAPI (indicated in the DLCI) not equal to "0" will cause one of the following actions:

- the triggering of a data link set up to support the message transfer across the radio interface if no suitable link exists;
- the transmission of the message to the MS if a suitable link has already been established;
- the sending of a BSSMAP SAPI "N" REJECT message to the MSC if for any reason the data link cannot be established, A Cause Information Element is included; typical Cause values are: "O&M intervention", "processor overload", "BSS not equipped", "MS not equipped".



### 3.1.18.2 Choice of the signalling link

When the BSS relays a message of the PDSS1 protocol received on the air interface to the MSC, it shall indicate in the DLCI (see 3GPP TS 48.002 [17]) on which control channel and SAPI the message was received.

When the MSC sends a DTAP message to the BSS, it shall,

- if the protocol of the corresponding air interface layer 3 message is PDSS1, specify on which control channel and SAPI of the air interface the L3 message shall be sent
- otherwise not further specify the control channel on the air interface.

When the BSS relays an air interface L3 message received in a DTAP message on the A interface to the MS, it shall

- if the DLCI does not further specify the signalling channel of the air interface, send it on the appropriate signalling link
- if the BSS supports PDSS1 and the DLCI specifies which control channel is to be used for transmission on the air interface, the BSS shall transfer the air interface L3 message on the specified control channel.

NOTE: If the BSS does not support PDSS1, it considers the part of the DLCI possibly indicating the control channel to be used on the air interface as spare bits, see 3GPP TS 48.002 [17].

## 3.1.19 BSSMAP Error Handling

To allow for the introduction of new functions the following rules shall be used to determine the actions of a receiving entity when it receives a message, part or all of which it is unable to understand. As the recipient is unable to tell the difference between a new, previously unspecified coding and an erroneous coding, the recipient also uses the same rules for error handling.

The robustness of a recipient in handling erroneous messages does not relax the requirement that the transmitter shall obey this Technical Specification. However, it is intended that functionality can be gradually added to an entity, and no obstacle to intermediate phase equipment is intended.

With the exception of subclause 3.1.19.6, the specific 'abnormal case' handling in other subclauses of 48.008 take precedence over this subclause.

### 3.1.19.1 Definitions of Types of Information Elements

The following definitions shall be used in subclause 3.1.19 and only in this subclause.

#### Essential Elements

These are the conditional elements when the condition for their reception is fulfilled, plus the Mandatory elements excluding the Cause value information element (3.2.2.5).

#### Mandatory Elements

These are the Information Elements marked as 'M' in subclause 3.2.1.

#### Non-Essential Elements

Non-essential elements are all the information elements that are not defined as essential.

#### Conditional Elements

In the indicated messages the following elements are conditional:

Circuit identity code in 3.2.1.1 and 3.2.1.8.

Circuit pool list in 3.2.1.3, 3.2.1.9, 3.2.1.16, and 3.2.1.55.

NOTE: A conditional IE is an IE whose presence or absence in a message can be determined by information contained in the rest of the message.

### Transparent Elements

The following elements are defined as transparent:

for the BSS: TMSI;

RR cause;

Layer 3 information in the BSSMAP HANDOVER COMMAND message; and

Layer 3 message contents; and for the MSC: Resource situation.

Layer 3 information in the BSSMAP HANDOVER REQUEST ACKNOWLEDGE message; and

"Old BSS to new BSS information" in the BSSMAP HANDOVER REQUIRED message

"Source RNC to target RNC information (UMTS)" in the BSSMAP HANDOVER REQUIRED message

"Source RNC to target RNC information (cdma2000)" in the BSSMAP HANDOVER REQUIRED message

### Non-Transparent Elements

Non-transparent elements are all the information elements that are not defined as transparent.

#### 3.1.19.2 Erroneous Events

The following events shall be regarded as errors by the recipient:

- 1 a message whose type is non-existent, unrecognisable, not consistent with the recipient's state, or, that is sent in the wrong direction. This includes messages that should use the SCCP connectionless service but that are received on an SCCP connection, and vice versa;
- 2 a missing essential information element;
- 3 use of a reserved codepoint in an information element that is both essential and non-transparent; and
- 4 an essential and non-transparent information element which is too short (the contents of any 'Length' octet shall be used to determine the boundary of the element).

When a recipient detects one or more of these events it shall return the appropriate error message with a suitable Cause value and the message shall be discarded.

#### 3.1.19.3 Non-erroneous Events

The following events shall not be regarded as errors by the recipient:

- 1 spare bits with an unexpected value in any information element;
- 2 the use of additional octets in any information element with a length octet;
- 3 a missing non-essential information element;
- 4 use of reserved codepoints in any non-essential information element or in any transparent information element; and
- 5 a non-essential information element or a transparent information element whose length is too short.

When the recipient detects one or more of these events the receiving entity shall ignore the information that it is unable to understand and treat the message on the basis of the information that remains.

Additionally,

all information in a message that is received after the start of an information element with an unrecognisable identifier shall be ignored. The message shall be accepted or rejected solely on the basis of the information received before the start of the unrecognisable element;

and,

when more information elements of a particular type are received than are expected, the last one(s) shall be ignored.

### 3.1.19.4 Other Events

The following events should be treated on a case by case basis and the outcome may depend upon the capabilities of the recipient.

- 1 The recipient may accept messages that contain information elements that do not appear to be in the correct sequence. Elements that occur more than once in a message shall be assumed to have been transmitted in the correct order. Recipients that do not accept out of sequence information elements shall regard the message as containing unexpected and/or missing information elements and follow the procedures of subclauses 3.1.19.1 and/or 3.1.19.2.
- 2 Where a field in an information element contains a value, which the recipient knows to be incorrect, the recipient shall either reject the message or it shall ignore that field, and treat the information that remains in the message.

(e.g. if the 'Number of MSs' in a Handover Candidate Response message is greater than the number of Handover Required messages received).

### 3.1.19.5 Appropriate Error Message and Cause Value

The choice of error message depends upon the received message type:

| <b>Received message type</b>              | <b>Error Message</b>               |
|---|------------------------------------|
| ASSIGNMENT REQUEST                        | ASSIGNMENT FAILURE                 |
| HANDOVER REQUEST                          | HANDOVER FAILURE                   |
| HANDOVER REQUIRED                         |                                    |
| if "Response Request" i.e. is present     | HANDOVER REQUIRED REJECT           |
| if "Response Request" i.e. is not present | CONFUSION                          |
| CIPHER MODE COMMAND                       | CIPHER MODE REJECT                 |
| VGCS/VBS SETUP                            | VGCS/VBS SETUP REFUSE              |
| VGCS/VBS ASSIGNMENT REQUEST               | VGCS/VBS ASSIGNMENT FAILURE        |
| CONFUSION                                 | an error message shall not be used |
| all other message types                   | CONFUSION                          |

When a problem is experienced with a message sent over an SCCP connection, the error message is returned over that connection. When a problem occurs in a message sent using the SCCP connectionless service, the error message is returned using the SCCP connectionless service.

To avoid overload of the A-interface, transmission of error messages may be inhibited. (However, the transmission of Assignment Failure, Handover Failure, Handover Required Reject and Cipher Mode Reject messages in the cases required by 3.1.1, 3.1.5 and 3.1.14 shall not be inhibited.) When the transmission of error messages is inhibited, they shall be replaced by some kind of notification to O&M. Several settings may be used to allow various subsets of 'error events' to trigger error messages while the remaining events only lead to O&M notification.

The Error pointer in the Diagnostics information element should be used to indicate the position of a detected error in the received message. Typical Causes are:

| Cause                                | Usage  |
|--------------------------------------|--|
| Invalid cell                         | Indicated cell not controlled by the BSS or not reachable through the MSC. May also be used for handover outside group call area.  |
| Invalid message contents             | May be used in any error message.  |
| Protocol error between BSS and MSC   | The received message is not consistent with the receiver's state, or the message has been sent in the wrong direction, or the message uses the wrong SCCP service (connection oriented instead of connectionless or vice versa). |
| Information element or field missing | Data missing from the area indicated by the error pointer.   |
| Incorrect value                      | A field (that should be indicated by the error pointer) contains an incorrect or incompatible value, or uses a reserved codepoint.   |
| Unknown message type                 | The received message was of an unknown type.   |
| Unknown information element          | An information element identifier (that should be indicated by the error pointer) contains an unknown value.   |

### 3.1.19.6 Unequipped Circuit Identification Code

If a MSC or BSS receives a message indicating one or more circuit which are unknown the following actions shall be taken:

- If an ASSIGNMENT REQUEST, a VGCS/VBS ASSIGNMENT REQUEST or a HANDOVER REQUEST message is received containing a circuit identity code which is unknown to the BSS the appropriate failure message is returned to the MSC. In addition the UNEQUIPPED CIRCUIT message is sent to the MSC for the circuit concerned.
- If an ASSIGNMENT COMPLETE, a VGCS/VBS ASSIGNMENT RESULT, a HANDOVER REQUEST ACKNOWLEDGE or a CHANGE CIRCUIT ACKNOWLEDGE Message is received containing a circuit identity code which is unknown to the MSC, it is up to the MSC to correct the situation, e.g. by performing a circuit re-selection procedure and sending an UNEQUIPPED CIRCUIT Message to the BSS.
- If a circuit supervision message (BLOCK, UNBLOCK or RESET CIRCUIT) is received containing a circuit identity code which is not known no respective acknowledgement is returned. Instead an UNEQUIPPED CIRCUIT Message is sent to the peer entity for the circuit concerned.
- If a circuit supervision acknowledgement message (BLOCKING ACKNOWLEDGE, UNBLOCKING ACKNOWLEDGE or RESET CIRCUIT ACKNOWLEDGE) is received containing a circuit identity code which is not known, an UNEQUIPPED CIRCUIT message is sent to the peer entity for the circuit concerned.
- If a circuit group supervision message (GROUP BLOCK, GROUP UNBLOCK) is received which affects one or more circuits which are unknown to the own entity the returned acknowledgement message shall not contain any information about these circuit(s), i.e. the respective status bit(s) in the status field shall not be set. Instead an UNEQUIPPED CIRCUIT Message is sent to the peer entity for the circuit(s) concerned.
- If a circuit group supervision acknowledgement message (CIRCUIT GROUP BLOCKING ACKNOWLEDGE or CIRCUIT GROUP UNBLOCKING ACKNOWLEDGE) is received which affects one or more circuits which are unknown to the own entity an UNEQUIPPED CIRCUIT message is sent to the peer entity for the circuit(s) concerned.
- If an UNEQUIPPED CIRCUIT Message is received indicating a circuit which is unknown in the own entity no UNEQUIPPED CIRCUIT Message will be returned.

If an UNEQUIPPED CIRCUIT Message is received indicating a circuit(s) that is known to the recipient, the indicated circuit(s) should be removed from service and the situation should be reported to the maintenance system for further intervention. The UNEQUIPPED CIRCUIT message is not to be acknowledged by the recipient.

### 3.1.19.7 Field Elements

This section defines the generic error handling to be applied to the field elements found in the "Old BSS to new BSS information" information element.

All field elements shall be treated as non-essential.

The following events shall not be regarded as errors by the recipient:

- spare bits with an unexpected value in any field element;
- the use of additional octets in any field element;
- a missing field element;
- a field element whose length is either too short or too long

When the recipient detects one or more of these events the receiving entity shall ignore the information that it is unable to understand and treat the message on the basis of the information that remains.

Additionally,

When an unknown field element identifier is encountered, the unknown field element shall be skipped and the receiver shall continue processing any remaining field elements;

and,

when more field elements of a particular type are received than are expected, the last one(s) shall be ignored;

and,

when a sub-field in a field element contains a value, which the recipient knows to be incorrect, the recipient shall either ignore that sub-field or ignore the entire field (treating it as if the field element had not been received).

and,

when a sub-field in a field element contains a reserved value, the recipient shall ignore the entire field element (treating it as if the field element had not been received).

### 3.1.20 Load Indication Procedure

The purpose of the load indication procedure is to inform all neighbour BSS's about the traffic situation of a cell.

The philosophy is to control the incoming handover traffic at the source, i.e. the BSS of the concerned cell informs all of its neighbour BSS's about the load situation. This is achieved by sending a LOAD INDICATION message to the neighbour BSS's. On receipt of the LOAD INDICATION message the BSS may analyse the load information and take the traffic load into consideration when deciding a handover.

The algorithm in which the BSS decides on starting a Load Indication procedure is operator dependent.

The implementation of the Load Indication procedure shall be regarded as optional, that means, if this procedure is not used, the Load Indication message may be ignored by these network elements.

### 3.1.20.1 Operation of the procedure

The procedure operates as follows:

The BSS shall send the LOAD INDICATION message to the MSC with the following information:

- Cell Identifier of the cell where the traffic load situation takes place (Cell Identifier information element).
- The Time indication information element contains the time where the traffic load information shall be valid on the receiving side.
- The Cell identifier list information element contains the cell identifier of the affected neighbour cells.
- The information about the total number of channels accessible or in use, and the information about the current number of channels available for each reported channel type on the indicated cell (Resource situation information element).
- The reason for sending this message (Cause information element).

On receipt of the LOAD INDICATION message, the MSC transmits this message to all BSS's as derived from the Cell identifier list Information Element.

**NOTE:** In the case where more than one indicated cells in the cell identifier list IE belong to the same BSS, the MSC should try to send the LOAD INDICATION message only once to this BSS.

With each reception of a LOAD INDICATION message from the MSC the target BSS shall analyse the resource information and adapt the handover traffic either from all cells of the BSS-area or only from the cells contained in the Cell identifier list Information Element to the cell indicated in the Cell identifier Information Element. The BSS shall ignore all Cell identifiers for cells which do not belong to its area.

In the case where the BSS receives a LOAD INDICATION message without the Resource situation information element, that means the indicated cell is not able to perform incoming handover requests and the receiving BSS may stop the whole handover traffic to this cell.

The traffic load information shall only be valid the time as indicated in the Time indication Information Element. The control timer shall be stopped with the receipt of a new LOAD INDICATION message and restarted with the new value. If the Time field contains the value 0, the load information is no longer valid.

### 3.1.21 Voice group call service and voice broadcast service call set-up and resource assignment

To set-up a VGCS/VBS call the MSC initiates the VGCS/VBS set-up procedure to the BSS. The MSC can then allocate resources to the VGCS/VBS call by initiating the VGCS/VBS Assignment procedure.

#### 3.1.21.1 Successful operation

To initiate a VGCS/VBS call set-up procedures the MSC sends to the BSS a VGCS/VBS SETUP message across VGCS/VBS call controlling SCCP connection. This connection is established for the life time of the VGCS/VBS call.

The BSS allocates resources to the call and returns VGCS/VBS SETUP ACK message to the MSC.

#### 3.1.21.2 VGCS/VBS call set-up abnormal cases

If the BSS detects that the VGCS/VBS call is already set-up it will clear all resources associated with the previous call and proceed with the new call.

#### 3.1.21.3 VGCS/VBS call set-up failure

If the BSS can not set-up the VGCS/VBS call then it will send an VGCS/VBS SETUP REFUSE message to the MSC.

### 3.1.22 Voice group call service and voice broadcast service Assignment procedure

The purpose of the VGCS/VBS Assignment procedure is to ensure that the correct dedicated radio resources are allocated to the VGCS/VBS call on a per cell basis. In order to support this procedure the MSC sets up a VGCS/VBS resource controlling SCCP connection to the BSS. This connection is then used to support all BSSAP messages related to the dedicated resource(s).

The MSC can command that the radio resources are either allocated immediately or delayed.

#### 3.1.22.1 Successful operation

The VGCS/VBS call controlling SCCP connection shall be established before the VGCS/VBS Assignment procedure takes place.

The MSC initiates the VGCS/VBS Assignment procedure to the BSS by sending an VGCS/VBS ASSIGNMENT REQUEST on a VGCS/VBS resource controlling SCCP connection.

The BSS will return VGCS/VBS ASSIGNMENT RESULT to the MSC to inform the MSC of the resources allocated by the BSS for the concerned cell.

The BSS shall initiate the radio interface notification procedure on the NCH of the cell in which the call is to take place, this may continue at regular intervals until the call is released. The BSS may on SACCH indicate that a change of notification has occurred and/or initiate notification on FACCH.

In the case where the BSS deallocates/allocates resources to the cell, the BSS sends an VGCS/VBS ASSIGNMENT RESULT message on the VGCS/VBS resource controlling SCCP connection associated to the cell.

In the case of voice group calls, if the MSC has informed the BSS to which voice group call the originator MS belongs to, the BSS may decide to modify the originator dedicated channel into a voice group call channel relating to the group call reference. If the BSS mode modifies the channel it will send the VGCS/VBS ASSIGNMENT RESULT message on the resource controlling SCCP connection and then immediately afterwards send a CLEAR REQUEST cause "Joined group call channel" on the originator dedicated connection.

#### 3.1.22.2 VGCS/VBS Assignment abnormal cases

In the abnormal case, where a BSS detects that a voice broadcast or voice group call already exists with the same group call reference in a cell (this may occur due to SCCP problems), the BSS shall release the radio resources associated with the cell for the present existing voice broadcast or voice group call and shall allocate resources to the new call.

If the BSS receives a VGCS/VBS ASSIGNMENT REQUEST message calling up a terrestrial circuit that is already assigned to another call then a VGCS/VBS ASSIGNMENT FAILURE message will be returned with a Cause value of: "terrestrial circuit already allocated" and no action will be taken on the radio interface.

If the BSS receives a VGCS/VBS ASSIGNMENT REQUEST message allocating a terrestrial circuit which has been blocked by a previous blocking procedure, then an VGCS/VBS ASSIGNMENT FAILURE message shall be sent (Cause value: "requested terrestrial resource unavailable"). A BLOCK message (not repeated and not guarded by timer T1) shall be sent for that concerned terrestrial circuit.

#### 3.1.22.3 VGCS/VBS Assignment failure

In the case where the VGCS/VBS call is unknown by the BSS, the BSS shall return the VGCS/VBS ASSIGNMENT FAILURE message (cause "VGCS/VBS call non existent").

In the case where no radio resource can be allocated to the VGCS/VBS call, the BSS shall return the VGCS/VBS ASSIGNMENT FAILURE message (cause "No radio resource available").

In the case where no radio resource can be allocated to the VGCS/VBS call for channel establishment on demand, the BSS shall return the CLEAR REQUEST message (cause "No radio resource available").

In the case where the MSC has attempted to assign a terrestrial circuit and an VGCS/VBS ASSIGNMENT FAILURE message has been returned then both the MSC and the BSS shall consider that the terrestrial circuit is idle (except already allocated or blocked terrestrial circuit) and therefore no explicit clearing sequence is needed.

### 3.1.23 Void

### 3.1.24 Voice group call uplink control procedure

In the case of voice group calls the uplink resource allocated to the call is controlled by the uplink control procedure. The uplink control procedure uses messages sent on the VGCS/VBS controlling SCCP connection set-up by the VGCS/VBS call set-up procedure.

The procedure is split into three procedures: uplink allocation; uplink release; & uplink seize.

The uplink allocation is controlled by the BSSs and group call anchor MSC. The BSS controls the uplink access for the cells in the group call area which are under its control. The group call anchor MSC controls the uplink access for the complete service area. Any allocation of the uplink access by a BSS may be refused later by the group call anchor MSC (due to the allocation of the uplink by other BSSs involved in the same voice group call).

The uplink release & uplink seize procedure is controlled and initiated by the MSC, the BSS obeys the MSC's requests.

When the voice group call is initially set-up the state of the uplink in each BSS is such that the uplink is seized. The MSC will control the state of the uplink in each BSS by use of the uplink release and uplink seize procedures. Before an uplink may be allocated by the BSS, the MSC must have released the uplink by initiating the uplink release procedure.

#### 3.1.24.1 Uplink allocation procedure

The uplink allocation procedure allows a listening user in a voice group call to talk on the uplink of the TCH dedicated to the voice group call in the cell.

The uplink allocation procedure can only occur once the group call anchor MSC has released the uplink (by use of the uplink release procedure).

When a mobile relinquishes the uplink or the BSS detects that the MS is no longer connected, the BSS sends to the MSC an UPLINK RELEASE INDICATION message cause "Call control" or "Radio interface message failure" respectively, the BSS may initiate the radio interface uplink free procedure.

##### 3.1.24.1.1 Successful uplink allocation operation

On reception of a request to talk, the BSS sends an UPLINK REQUEST message to the MSC. The MSC sends the UPLINK REQUEST ACKNOWLEDGE message to confirm to the BSS that the uplink is granted to the requesting MS. The MSC also sends to all the other BSSs in the voice group call an UPLINK SEIZED COMMAND message.

The BSS sends UPLINK REQUEST CONFIRMATION message with the complete layer information, once the radio link has been established.

##### 3.1.24.1.2 Unsuccessful uplink allocation operation

In the case that the radio link could not be established the BS sends the Uplink release indication with the cause "Radiolink interface message failure".

In the case the MSC does not want to grant the uplink, the MSC will send an UPLINK REJECT COMMAND message to the appropriate BSS. On reception of this the BSS will release the uplink for the requesting MS.

#### 3.1.24.2 Uplink release procedure

This procedure shall be used in one of the following cases:

- the group call anchor MSC detects that none of the parties involved in a voice group call are talking . The Uplink release procedure is then used to allow the listening subscribers to talk
- the group call anchor or relay MSC detects that the talker has left the Group Call Area

To initiate this procedure the group call anchor MSC sends the UPLINK RELEASE COMMAND message to each BSS involved in the voice group call. When the BSS receives the Uplink release request command, the BSS shall initiate the radio interface uplink release procedure.



### 3.1.24.3 Uplink seize procedure

Once the group call anchor MSC has released the uplink it may detect speech on dedicated channel(s), in this case the MSC will send to all BSSs involved in the voice group call an UPLINK SEIZED COMMAND message. On reception of the UPLINK SEIZED COMMAND message the BSS will initiate the radio interface uplink busy procedure.

### 3.1.25 PDSS1 flow control

The purpose of the PDSS1 flow control procedure is to inform the MSC that it should stop or resume transmission of PDSS1 data on this particular transaction.

The BSS may on the relevant SCCP connection associated with an MS transaction send a SUSPEND message to the MSC to ask the MSC not to transmit DTAP messages carrying air interface layer 3 messages of the PDSS1 protocol. A typical reason is that too many messages are scheduled for transmission on the air interface.

The BSS may on the relevant SCCP connection associated with an MS transaction send a RESUME message to the MSC to indicate to the MSC that DTAP messages carrying air interface layer 3 messages of the PDSS1 protocol may be transmitted (the typical reason is that congestion on the air interface signalling channel does no more exist).

### 3.1.26 Circuit re-selection procedure

This procedure has to be supported by a BSS if and only if it allocates the A interface circuits.

The MSC can request the BSS to change the circuit allocated to a connection by sending a CHANGE CIRCUIT message to the BSS on the corresponding SCCP connection. The MSC releases the allocated circuit at the sending of the CHANGE CIRCUIT message.

The MSC shall not start the circuit re-selection procedure if another procedure is on-going that may result in the change of the circuit (e.g., circuit re-selection, handover or clearing).

At the reception of a CHANGE CIRCUIT message, and if the BSS is not already engaged in a procedure that normally results in the release of the allocated circuit (e.g., handover or clearing), the BSS allocates a new circuit and indicates it in CHANGE CIRCUIT ACKNOWLEDGE message sent back to the MSC. The BSS releases the previously allocated circuit after the sending of the CHANGE CIRCUIT ACKNOWLEDGE message.

If the MSC receives a message from the BSS indicating the start of a procedure that may result in the change of the circuit (e.g., reception of HANDOVER REQUIRED or CLEAR REQUEST), the MSC shall abort the circuit re-selection procedure.

The MSC may not be able to use the terrestrial resource that the BSS has indicated. In this case, the procedure is nevertheless considered terminated successfully, and it is up to the MSC to correct the situation, e.g., by a new circuit re-selection procedure.

### 3.1.27 LSA handling

The MSC may send the LSA INFORMATION message at any time during the lifetime of the relevant SCCP connection. The message is not acknowledged.

The BSS shall store the LSA identity list internally for the connection and use it for the control of internal and external handover.

In the case of overlapping LSAs, the LSA identity signalled in messages by the BSS towards the MSC shall be the LSA identity with the highest priority.

Upon reception of a new lists of LSA identities the BSS will discard the previous LSA identity list and use the new LSA identity list. The BSS shall always accept the LSA identity list, but shall ignore LSA identities, which are not known.

If the subscriber has LSA only access this has to be taken into account in the "Cell Identifier List (preferred)" in the HANDOVER REQUIRED message (see subclause "Generation of the HANDOVER REQUIRED message"). If the subscriber has LSA only access the LSA only access indicator is set to zero at an emergency call.

Exclusive access cells may be included into "Cell Identifier List (preferred)" in the HANOVER REQUIRED message (see subclause "Generation of the HANOVER REQUIRED message") if at least one LSA identity defined in the exclusive access cell corresponds to any LSA identity received in the HANOVER REQUEST or the latest LSA INFORMATION message. Exclusive access cells may also be included if the connection is an emergency call.

### 3.1.28 Location Acquisition

This procedure is utilized to support Location Services (see 3GPP TS 43.071 [5]). It is used to pass information transparently between the SMLC and BSS and request location of the target MS from the BSS.

#### 3.1.28.1 Void

#### 3.1.28.2 Location request

##### 3.1.28.2.1 Successful Operation

PERFORM LOCATION REQUEST message may be sent in order to perform location procedure for the target MS. This message may be sent from the MSC to the BSS. This message contains following information:

- Location type
- Cell Identifier
- Classmark Information Type 3
- LCS Client Type
- Chosen Channel
- LCS Priority
- Quality of service
- GPS Assistance Data
- APDU, variable length octet string of which content is defined in 3GPP TS 49.031 [19a] and 3GPP TS 48.071 [19].

On receipt of the PERFORM LOCATION REQUEST message for positioning of the target MS, the BSS transfers the positioning request to the SMLC according to the procedures defined in 3GPP TS 43.059 [5] and 3GPP TS 49.031 [19a] and awaits the result. The BSS then returns the result of positioning to the MSC in the PERFORM LOCATION RESPONSE message. This message contains following information:

- Location estimate
- Positioning data

If assistance data was instead requested by the MSC for an MS, the BSS transfers the request to the SMLC according to the procedures defined in 3GPP TS 43.059 [5] and 3GPP TS 49.031 [19a] and awaits the result. If the SMLC was able successfully to transfer this to the MS, the BSS shall return a PERFORM LOCATION RESPONSE message to the MSC. This message shall contain no parameters. The absence of an LCS Cause parameter in this case implies that the transfer was successful.

Otherwise, if a deciphering keys were requested for LCS broadcast assistance data, the BSS transfers the request to the SMLC according to the procedures defined in 3GPP TS 43.059 [5] and 3GPP TS 49.031 [19a] and awaits the result. If the SMLC has access to the appropriate keys, the BSS shall return a PERFORM LOCATION RESPONSE message to MSC. This message contains following information:

- Deciphering Keys

### 3.1.28.2.2 Unsuccessful Operation

If the BSS fails to respond to the PERFORM LOCATION REQUEST message it returns a PERFORM LOCATION RESPONSE message with a LCS cause value indicating the failure cause. Possible failure causes are listed in 3GPP TS 49.031 [19a].

### 3.1.28.2.3 Abnormal cases

The following condition may occur:

If the MSC needs to abort previously initiated location request, it shall send the PERFORM LOCATION ABORT message to the BSS. As a result of reception of this message the BSS shall abort activities related to positioning of the target MS or assistance data delivery. The BSS shall return a PERFORM LOCATION RESPONSE with a cause value indicating the abortion of location request.

### 3.1.28.2.4 Overload

For location requests initiated by the MSC, the BSC may employ the same procedures defined for an SMLC in 3GPP TS 49.031 [19a] to alleviate an overload condition in the BSS.

## 3.1.29 Connectionless Information Transfer procedure

The SMLC may send information to another SMLC transparently via the BSS, or via BSS and MSC.

The CONNECTIONLESS INFORMATION message shall be sent via the BSSMAP as a connectionless message.

The BSS shall send the CONNECTIONLESS INFORMATION message to the MSC with the following information:

- Network Element Identity (source), which define the source SMLC for the message.
- Network Element Identity (target), which define the target SMLC for the message.
- Variable length octet string (APDU IE), of which content is defined in 3GPP TS 49.031 [19a]
- Segmentation IE containing segmentation and message identification: included only with a segmented APDU
- The Return Error Request may be included to request notification in the event of unsuccessful transfer.

On receipt of the CONNECTIONLESS INFORMATION message, the MSC transmits this message to another MSC or BSS on a direct path to the target SMLC, as derived from the Network Element Identity (target) IE. The contents of APDU IE is transparent to the MSC.

If the source SMLC and the target SMLC are associated with different MSCs, then the CONNECTIONLESS INFORMATION message shall be forwarded between MSCs via the BSSMAP-LE as a connectionless message (see 3GPP TS 49.031 [19a]).

### 3.1.29.1 Unsuccessful Operation

Unsuccessful operation is specified within Connectionless Information Transfer procedure in 3GPP TS 49.031 [19a].

### 3.1.29.2 Abnormal cases

Abnormal cases are specified within Connectionless Information Transfer procedure in 3GPP TS 49.031 [19a].

### 3.1.29.3 Segmentation

The Segmentation parameter shall not be included if the APDU is not segmented.

If the size of an embedded SMLCPP message is too large to fit into one CONNECTIONLESS INFORMATION message, the sending entity divides the SMLCPP message to a necessary number of CONNECTIONLESS INFORMATION messages each containing an APDU IE and a Segmentation IE. In the APDU IE it includes as many octets as possible.

The segmentation IE contains a segment number, an indication of the final segment and the message ID. The order number of a segment in the Segment Number field in the SEGMENTATION IE is incremented by one starting from zero, i.e. the value is 0 for the first segment, 1 for the next and so on. The receiving entity recognizes that a segment is missing or duplicated, when

- There is more than one segment with the same segment number and same Message ID.
- The segment number does not increase by steps of one starting from zero.

If the recipient recognizes a missing or duplicated element, it shall discard the entire message (i.e. all received segment with the message ID).

The message identity in the Message ID field in the SEGMENTATION IE is used to recognize a particular message to which the segment belongs. The sending entity can select any of the available values (0 - 65535) that is not currently used between it and the receiving entity.

If an APDU segment is received with Return Error cause IE (due to invocation of the return error option), reassembly does not apply and the APDU segment and error cause maybe returned to the original source application.

### 3.1.30 Common ID

The purpose of the Common ID procedure is to inform the BSC about the IMSI of a user. This may be used by the BSC to create a reference between the user and the RR and SCCP connections of that user for paging co-ordination. The procedure uses connection oriented signalling.

If the MS, the BSS and the MSC support DTM and as soon as the IMSI is available at the MSC, the MSC shall send the COMMON ID message to the BSS.

The BSC associates the permanent identity to the RR and SCCP connections of that user for the duration of the RR connection.

## 3.2 Message Formats and Coding

This subclause defines the coding and format of the messages required for the BSSMAP.

For each message there is, in subclause 3.2.1, a table listing the signalling elements in their order of appearance in the transmitted message.

There is no general rule for the order of signalling elements: it happens that the same elements appear in various orders depending on the message.

All the BSSMAP messages are listed in the following table:

| Message name                         | Reference |
|--------------------------------------|-----------|
| ASSIGNMENT REQUEST                   | 3.2.1.1   |
| ASSIGNMENT COMPLETE                  | 3.2.1.2   |
| ASSIGNMENT FAILURE                   | 3.2.1.3   |
| BLOCK                                | 3.2.1.4   |
| BLOCKING ACKNOWLEDGE                 | 3.2.1.5   |
| CIRCUIT GROUP BLOCK                  | 3.2.1.41  |
| CIRCUIT GROUP BLOCKING ACKNOWLEDGE   | 3.2.1.42  |
| CIRCUIT GROUP UNBLOCK                | 3.2.1.43  |
| CIRCUIT GROUP UNBLOCKING ACKNOWLEDGE | 3.2.1.44  |
| CLEAR COMMAND                        | 3.2.1.21  |
| CLEAR COMPLETE                       | 3.2.1.22  |
| CLEAR REQUEST                        | 3.2.1.20  |
| UNBLOCK                              | 3.2.1.6   |
| UNBLOCKING ACK                       | 3.2.1.7   |
| HANDOVER CANDIDATE ENQUIRE           | 3.2.1.14  |
| HANDOVER CANDIDATE RESPONSE          | 3.2.1.15  |
| HANDOVER REQUEST                     | 3.2.1.8   |
| HANDOVER REQUIRED                    | 3.2.1.9   |
| HANDOVER REQUIRED REJECT             | 3.2.1.37  |
| HANDOVER REQUEST ACKNOWLEDGE         | 3.2.1.10  |
| HANDOVER COMMAND                     | 3.2.1.11  |
| HANDOVER COMPLETE                    | 3.2.1.12  |
| HANDOVER SUCCEEDED                   | 3.2.1.13  |
| HANDOVER FAILURE                     | 3.2.1.16  |
| HANDOVER PERFORMED                   | 3.2.1.25  |
| HANDOVER DETECT                      | 3.2.1.40  |
| RESOURCE REQUEST                     | 3.2.1.17  |
| RESET                                | 3.2.1.23  |
| RESET ACK                            | 3.2.1.24  |
| RESOURCE INDICATION                  | 3.2.1.18  |
| PAGING                               | 3.2.1.19  |
| OVERLOAD                             | 3.2.1.26  |
| MSC INVOKE TRACE                     | 3.2.1.27  |
| BSS INVOKE TRACE                     | 3.2.1.28  |
| CLASSMARK UPDATE                     | 3.2.1.29  |
| CLASSMARK REQUEST                    | 3.2.1.46  |
| CIPHER MODE COMMAND                  | 3.2.1.30  |
| CIPHER MODE COMPLETE                 | 3.2.1.31  |
| CIPHER MODE REJECT                   | 3.2.1.48  |
| COMPLETE LAYER 3 INFORMATION         | 3.2.1.32  |
| QUEUING INDICATION                   | 3.2.1.33  |
| SAPI "N" REJECT                      | 3.2.1.34  |
| RESET CIRCUIT                        | 3.2.1.38  |
| RESET CIRCUIT ACKNOWLEDGE            | 3.2.1.39  |
| CONFUSION                            | 3.2.1.45  |
| UNEQUIPPED CIRCUIT                   | 3.2.1.47  |
| LOAD INDICATION                      | 3.2.1.49  |
| VGCS/VBS SETUP                       | 3.2.1.50  |
| VGCS/VBS SETUP ACK                   | 3.2.1.51  |
| VGCS/VBS SETUP REFUSE                | 3.2.1.52  |
| VGCS/VBS ASSIGNMENT REQUEST          | 3.2.1.53  |
| VGCS/VBS ASSIGNMENT RESULT           | 3.2.1.54  |
| VGCS/VBS ASSIGNMENT FAILURE          | 3.2.1.55  |
| VGCS/VBS QUEUING INDICATION          | 3.2.1.56  |
| UPLINK REQUEST                       | 3.2.1.57  |
| UPLINK REQUEST ACKNOWLEDGE           | 3.2.1.58  |
| UPLINK REQUEST CONFIRMATION          | 3.2.1.59  |
| UPLINK RELEASE INDICATION            | 3.2.1.60  |
| UPLINK REJECT COMMAND                | 3.2.1.61  |
| UPLINK RELEASE COMMAND               | 3.2.1.62  |
| UPLINK SEIZED COMMAND                | 3.2.1.63  |
| SUSPEND                              | 3.2.1.64  |

| Message name                    | Reference |
|---------------------------------|-----------|
| RESUME                          | 3.2.1.65  |
| CHANGE CIRCUIT                  | 3.2.1.66  |
| CHANGE CIRCUIT ACKNOWLEDGE      | 3.2.1.67  |
| COMMON ID                       | 3.2.1.68  |
| LSA INFORMATION                 | 3.2.1.69  |
| CONNECTION ORIENTED INFORMATION | 3.2.1.70  |
| PERFORM LOCATION REQUEST        | 3.2.1.71  |
| PERFORM LOCATION RESPONSE       | 3.2.1.72  |
| PERFORM LOCATION ABORT          | 3.2.1.73  |
| CONNECTIONLESS INFORMATION      | 3.2.1.74  |

## 3.2.1 Message Contents

### 3.2.1.1 ASSIGNMENT REQUEST

This message is sent from the MSC to the BSS via the relevant SCCP connection in order to request the BSS to assign radio resource(s), the attributes of which are defined within the message.

The message may also include the terrestrial circuit to be used.

| INFORMATION ELEMENT                | REFERENCE | DIRECTION | TYPE  | LEN  |
|------------------------------------|-----------|-----------|-------|------|
| Message Type                       | 3.2.2.1   | MSC-BSS   | M     | 1    |
| Channel Type                       | 3.2.2.11  | MSC-BSS   | M     | 5-10 |
| Layer 3 Header Information         | 3.2.2.9   | MSC-BSS   | O (3) | 4    |
| Priority                           | 3.2.2.18  | MSC-BSS   | O     | 3    |
| Circuit Identity Code              | 3.2.2.2   | MSC-BSS   | O (1) | 3    |
| Downlink DTX Flag                  | 3.2.2.26  | MSC-BSS   | O (2) | 2    |
| Interference Band To Be Used       | 3.2.2.21  | MSC-BSS   | O     | 2    |
| Classmark Information 2            | 3.2.2.19  | MSC-BSS   | O (4) | 4-5  |
| Group Call Reference               | 3.2.2.55  | MSC-BSS   | O (5) | 3-8  |
| Talker Flag                        | 3.2.2.54  | MSC-BSS   | O (6) | 1    |
| Configuration Evolution Indication | 3.2.2.57  | MSC-BSS   | O (7) | 2    |
| LSA Access Control Suppression     | 3.2.2.61  | MSC-BSS   | O (8) | 2    |
| Service Handover                   | 3.2.2.75  | MSC-BSS   | O (9) | 3    |

- 1 This element is included when the MSC allocates the A interface circuits and the channel type Information Element indicates speech or data, and only in those cases.
- 2 This element may be included in the case of a speech TCH, and only in this case. If not included, this has no impact on the DTX function in the BSS.
- 3 This information element doesn't serve any useful purpose. MSCs should not send the information element unless it is required by the recipients (due to the need to interwork with older versions of the protocol). It is expected that in future versions of 48.008, this information element will be deleted from this message.
- 4 These elements may be included if the information is known by the MSC.
- 5 This may be included by the MSC for either a talking or listening subscriber in a group call.
- 6 This information element is included for group calls, when this is included it indicates that the mobile is a talker in the call else the mobile is a listener.
- 7 The information is indicated by the MSC if known.
- 8 This information element is included if LSA access control function shall be suppressed in the BSS.
- 9 This information element is included if a preference for other radio access technologies shall be applied to the MS connection.

### 3.2.1.2 ASSIGNMENT COMPLETE

The ASSIGNMENT COMPLETE message is sent from the BSS to the MSC and indicates that the requested assignment has been completed correctly.

The message is sent via the BSSAP SCCP connection associated with the dedicated resource(s).

| INFORMATION ELEMENT         | REFERENCE | DIRECTION | TYPE  | LEN  |
|-----------------------------|-----------|-----------|-------|------|
| Message Type                | 3.2.2.1   | BSS-MSC   | M     | 1    |
| RR Cause                    | 3.2.2.22  | BSS-MSC   | O     | 2    |
| Circuit Identity Code       | 3.2.2.2   | BSS-MSC   | O (4) | 3    |
| Cell Identifier             | 3.2.2.17  | BSS-MSC   | O (1) | 3-10 |
| Chosen Channel              | 3.2.2.33  | BSS-MSC   | O (3) | 2    |
| Chosen Encryption Algorithm | 3.2.2.44  | BSS-MSC   | O (5) | 2    |
| Circuit Pool                | 3.2.2.45  | BSS-MSC   | O (2) | 2    |
| Speech Version (Chosen)     | 3.2.2.51  | BSS-MSC   | O (6) | 2    |
| LSA Identifier              | 3.2.2.15  | BSS-MSC   | O (7) | 5    |

- 1 The cell identifier is used to indicate a new cell, if during the assignment the serving cell has changed. When sent from 3G\_MSC-B over MAP/E interface this information element contains indication of Cell Identifier (e.g. CGI) if the new serving cell is GSM or indication of either RNC-ID or SAI (if known) if the new serving cell is UMTS. Note; RNC-ID or SAI are only provided in the ASSIGNMENT COMPLETE message over the MAP-E interface.
- 2 Shall be included when several circuit pools are present on the BSS MSC interface and a circuit was allocated by the ASSIGNMENT REQUEST message.
- 3 Included at least when the channel rate/type choice was done by the BSS.
- 4 The Circuit Identity Code information element is included mandatorily by the BSS if the BSS allocates the A interface circuits and a circuit is needed.
- 5 Included at least when the encryption algorithm has been changed by the BSS.
- 6 Included at least when the speech version choice was done by the BSS.
- 7 Shall be included if current LSA in the serving cell has been identified (see 3GPP TS 43.073 [40]). Not included means that there is no current LSA in the serving cell.

### 3.2.1.3 ASSIGNMENT FAILURE

The ASSIGNMENT FAILURE message is sent from the BSS to the MSC via the relevant SCCP connection. It indicates that there has been a failure in the assignment process at the BSS and that the assignment procedure has been aborted.

| INFORMATION ELEMENT | REFERENCE | DIRECTION | TYPE  | LEN |
|---------------------|-----------|-----------|-------|-----|
| Message Type        | 3.2.2.1   | BSS-MSC   | M     | 1   |
| Cause               | 3.2.2.5   | BSS-MSC   | M     | 3-4 |
| RR Cause            | 3.2.2.22  | BSS-MSC   | O     | 2   |
| Circuit Pool        | 3.2.2.45  | BSS-MSC   | O (1) | 2   |
| Circuit Pool List   | 3.2.2.46  | BSS-MSC   | O (2) | V   |

- 1 Shall be included when several circuit pools are present on the BSS MSC interface.
- 2 May be included when cause is "circuit pool mismatch" or "switch circuit pool" to indicate circuit pool preferences.

Typical Cause values are:

radio interface message failure,  
 O and M intervention,  
 equipment failure,  
 no radio resource available,  
 requested terrestrial resource unavailable,  
 requested transcoding/rate adaption unavailable,

terrestrial resource already allocated,  
 invalid message contents,  
 radio interface failure - reversion to old channel,  
 directed retry,  
 circuit pool mismatch,  
 switch circuit pool.  
 requested speech version unavailable.

### 3.2.1.4 BLOCK

This message is sent from the BSS to the MSC or from the MSC to the BSS to indicate that a particular terrestrial resource (i.e. a particular timeslot within a 2Mbit system) must be remotely blocked at the circuit master, and cannot therefore be used for traffic.

This message is sent as a connectionless SCCP message.

| INFORMATION ELEMENT          | REFERENCE | DIRECTION | TYPE | LEN |
|------------------------------|-----------|-----------|------|-----|
| Message Type                 | 3.2.2.1   | both      | M    | 1   |
| Circuit Identity Code        | 3.2.2.2   | both      | M    | 3   |
| Cause                        | 3.2.2.5   | both      | M    | 3-4 |
| Connection Release Requested | 3.2.2.3   | MSC-BSS   | O    | 1   |

Typical Cause values are:

no radio resource available,  
 O and M intervention,  
 equipment failure.

### 3.2.1.5 BLOCKING ACKNOWLEDGE

This message is sent from the MSC to the BSS or from the BSS to the MSC to acknowledge the receipt of an earlier BLOCK message, and to indicate that the circuit concerned has been removed from service.

This message is sent as a connectionless SCCP message.

| INFORMATION ELEMENT   | REFERENCE | DIRECTION | TYPE | LEN |
|-----------------------|-----------|-----------|------|-----|
| Message Type          | 3.2.2.1   | both      | M    | 1   |
| Circuit Identity Code | 3.2.2.2   | both      | M    | 3   |

### 3.2.1.6 UNBLOCK

This message is sent from the BSS to the MSC or from the MSC to the BSS to indicate that a particular terrestrial resource (ie a particular timeslot within a 2 Mbit system) should not be remotely blocked any more on the receiver side.

This message is sent as a connectionless SCCP message.

| INFORMATION ELEMENT   | REFERENCE | DIRECTION | TYPE | LEN |
|-----------------------|-----------|-----------|------|-----|
| Message Type          | 3.2.2.1   | both      | M    | 1   |
| Circuit Identity Code | 3.2.2.2   | both      | M    | 3   |

### 3.2.1.7 UNBLOCKING ACKNOWLEDGE

This message is sent from the MSC to the BSS or from the BSS to the MSC to acknowledge the receipt of an earlier UNBLOCK message.

This message is sent as a connectionless SCCP message.

| INFORMATION ELEMENT   | REFERENCE | DIRECTION | TYPE | LEN |
|-----------------------|-----------|-----------|------|-----|
| Message Type          | 3.2.2.1   | both      | M    | 1   |
| Circuit Identity Code | 3.2.2.2   | both      | M    | 3   |



### 3.2.1.8 HANDOVER REQUEST

This message is sent from the MSC to the BSS via the relevant SCCP connection to indicate that the MS is to be handed over to that BSS.

| INFORMATION ELEMENT   | REFERENCE            | DIRECTION | TYPE   | LEN  |
|---|----------------------|-----------|--------|------|
| Message Type  | 3.2.2.1              | MSC-BSS   | M      | 1    |
| Channel Type  | 3.2.2.11             | MSC-BSS   | M      | 5-10 |
| Encryption Information  | 3.2.2.10             | MSC-BSS   | M (1)  | 3-n  |
| Classmark Information 1<br>or<br>Classmark Information 2          | 3.2.2.30<br>3.2.2.19 | MSC-BSS   | M#     | 2    |
| Cell Identifier (Serving)   | 3.2.2.17             | MSC-BSS   | M (20) | 5-10 |
| Priority  | 3.2.2.18             | MSC-BSS   | O      | 3    |
| Circuit Identity Code   | 3.2.2.2              | MSC-BSS   | O (7)  | 3    |
| Downlink DTX Flag   | 3.2.2.26             | MSC-BSS   | O (3)  | 2    |
| Cell Identifier (Target)  | 3.2.2.17             | MSC-BSS   | M (17) | 3-10 |
| Interference Band To Be Used                                      | 3.2.2.21             | MSC-BSS   | O      | 2    |
| Cause   | 3.2.2.5              | MSC-BSS   | O (9)  | 3-4  |
| Classmark Information 3   | 3.2.2.20             | MSC-BSS   | O (4)  | 3-14 |
| Current Channel type 1  | 3.2.2.49             | MSC-BSS   | O (8)  | 2    |
| Speech Version (Used)   | 3.2.2.51             | MSC-BSS   | O (10) | 2    |
| Group Call Reference  | 3.2.2.55             | MSC-BSS   | O (5)  | 3-8  |
| Talker Flag   | 3.2.2.54             | MSC-BSS   | O (11) | 1    |
| Configuration Evolution Indication                                | 3.2.2.57             | MSC-BSS   | O (12) | 2    |
| Chosen Encryption Algorithm<br>(Serving)                          | 3.2.2.44             | MSC-BSS   | O (2)  | 2    |
| Old BSS to New BSS Information                                    | 3.2.2.58             | MSC-BSS   | O(13)  | 2-n  |
| LSA Information   | 3.2.2.23             | MSC-BSS   | O(14)  | 3+4n |
| LSA Access Control Suppression                                    | 3.2.2.61             | MSC-BSS   | O (15) | 2    |
| Service Handover  | 3.2.2.75             | MSC-BSS   | O (21) | 3    |
| IMSI  | 3.2.2.6              | MSC-BSS   | O (16) | 3-10 |
| Source RNC to target RNC<br>transparent information (UMTS)        | 3.2.2.76             | MSC-BSS   | O (18) | n-m  |
| Source RNC to target RNC<br>transparent information<br>(cdma2000) | 3.2.2.77             | MSC-BSS   | O (19) | n-m  |

- 1 If the MSC has not sent a CIPHER MODE COMMAND for this RR connection (or has had all such CIPHER MODE COMMAND messages rejected with CIPHER MODE REJECT messages) then the MSC shall indicate that the only "permitted algorithm" is "no encryption".
- 2 If this information element is included, it shall be equal to the last received "Chosen Encryption Algorithm" information element.
- 3 This element may be included in the case of a speech TCH, and only in this case. If not included, this has no impact on the DTX function in the BSS.
- 4 This element is included if the MSC has received such information.
- 5 This element is included if the MS is in a voice broadcast or voice group call.
- 6 One of these two elements is sent.
- 7 This element is included when the channel type Information Element indicates speech or data, and only in those cases. In case of Voice Group Call talker handover, this element may contain the Circuit Identity Code already allocated during the VBS/VGCS assignment procedure, meaning that the already allocated terrestrial resource of the new cell is used.
- 8 This element is included at least when the message is sent as a reaction to reception of a HANDOVER REQUIRED message containing a "Current channel type 1" information element. In this case it shall be equal to the received element.
- 9 This information element should always be included. Its cause value should be the same as indicated in the corresponding Handover Required message.

- 10 This element is included at least when the message is sent as a reaction to reception of a HANOVER REQUIRED message containing a "Speech version (used)" information element. In this case it shall be equal to the received element.
- 11 This information element is included for voice group call, when this is included it indicates that the mobile is a talker in the call else the mobile is a listener.
- 12 The information is indicated by the MSC if known
- 13 This element is included if and only if the message is sent as a reaction to the reception of a HANOVER REQUIRED message containing an "old BSS to new BSS information" information element. Its contents shall be equal to the received element.
- 14 This information element is included when the subscriber has localised service area support.
- 15 This information element is included if LSA access control function shall be suppressed in the BSS.
- 16 This information element is included at least when the MS is dual transfer mode capable and the IMSI is available at the MSC.
- 17 If intersystem handover from GSM to UMTS or to cdma 2000 is performed, this information element indicates the target RNC-ID..
- 18 This information element shall be included when intersystem handover (UMTS) is performed. This element is included if and only if the message is sent as a reaction to the reception of a HANOVER REQUIRED message containing an "Source RNC to Target RNC transparent information (UMTS)" IE. Its contents shall be equal to the received element.

NOTE: Only provided in the HANOVER REQUEST message on the MAP-E interface.

- 19 This information element shall be included when intersystem handover (cdma2000) is performed. This element is included if and only if the message is sent as a reaction to the reception of a HANOVER REQUIRED message containing an "Source RNC to Target RNC transparent information (cdma2000)" IE. Its contents shall be equal to the received element. Note: Only provided in the HANOVER REQUEST message on the MAP-E interface.
- 20 In intersystem handover from UMTS (or cdma2000) to GSM this IE indicates the serving area of the UE.
- 21 This information element is included if a preference for other radio access technologies shall be applied to the MS connection..

Typical Cause values are:

- uplink quality,
- uplink strength,
- downlink quality,
- downlink strength
- distance,
- better cell,
- response to MSC invocation
- O and M intervention,
- directed retry,
- switch circuit pool,
- traffic,
- preemption.

### 3.2.1.9 HANDOVER REQUIRED

This message is sent from the BSS to the MSC to indicate that for a given MS which already has dedicated radio resource(s) assigned, a handover is required for the reason given by the cause element.

The message is sent via the BSSAP SCCP connection associated with the dedicated resource(s).

| INFORMATION ELEMENT   | REFERENCE | DIRECTION | TYPE  | LEN                |
|---|-----------|-----------|-------|--------------------|
| Message Type  | 3.2.2.1   | BSS-MSC   | M     | 1                  |
| Cause   | 3.2.2.5   | BSS-MSC   | M     | 3-4                |
| Response Request  | 3.2.2.28  | BSS-MSC   | O     | 1                  |
| Cell Identifier List<br>(Preferred)                               | 3.2.2.27  | BSS-MSC   | M (4) | 2n+3<br>to<br>7n+3 |
| Circuit Pool List   | 3.2.2.46  | BSS-MSC   | O (1) | V                  |
| Current Channel Type 1  | 3.2.2.49  | BSS-MSC   | O (2) | 2                  |
| Speech Version (Used)   | 3.2.2.51  | BSS-MSC   | O (3) | 2                  |
| Queueing Indicator  | 3.2.2.50  | BSS-MSC   | O     | 2                  |
| Old BSS to New BSS Information                                    | 3.2.2.58  | BSS-MSC   | O     | 2-n                |
| Source RNC to target RNC<br>transparent information (UMTS)        | 3.2.2.76  | BSS-MSC   | O (5) | 3-m                |
| Source RNC to target RNC<br>transparent information<br>(cdma2000) | 3.2.2.77  | BSS-MSC   | O (6) | n-m                |

- 1 Shall be included when cause "switch circuit pool" and the MSC allocates the A interface circuit.
- 2 This information element should always be included.
- 3 This information element should always be included when the channel mode is speech, and only in this case.
- 4 If intersystem handover from GSM to UMTS or to cdma2000 is performed, this information element indicates the target. Only one RNC identity is included for Intersystem Handover to UTRAN or to cdma2000.
- 5 This information element shall be included when intersystem handover (UMTS) is performed. Source RNC to target RNC information is a general container to carry Inter RAT Handover Info (UTRAN specific information) and Inter RAT UE radio access capability (Classmark Information Type 2 and Classmark Information Type 3) from BSS to RNC. The Inter RAT Handover Info and the Inter RAT UE radio access capability is conveyed in the RRC container Inter RAT Handover Info with Inter RAT Capabilities as defined in TS 25.331.
- 6 This information element shall be included when intersystem handover (cdma2000) is performed. Source RNC to target RNC information is a general container to carry cdma2000 specific information from BSS to RNC.

Typical Cause values are:

uplink quality,  
uplink strength,  
downlink quality,  
downlink strength,  
distance,  
better cell,  
response to MSC invocation,  
O&M intervention,  
directed retry,  
switch circuit pool,  
traffic,  
preemption.

### 3.2.1.10 HANDOVER REQUEST ACKNOWLEDGE

This message is sent from the BSS to the MSC and indicates that the request to support a handover at the target BSS can be supported by the BSS, and also to which radio channel(s) the MS should be directed.

The message is sent via the BSSAP SCCP connection associated with the dedicated resource.

| INFORMATION ELEMENT         | REFERENCE | DIRECTION | TYPE  | LEN  |
|-----------------------------|-----------|-----------|-------|------|
| Message Type                | 3.2.2.1   | BSS-MSC   | M     | 1    |
| Layer 3 Information         | 3.2.2.24  | BSS-MSC   | M (1) | 11-n |
| Chosen Channel              | 3.2.2.33  | BSS-MSC   | O (4) | 2    |
| Chosen Encryption Algorithm | 3.2.2.44  | BSS-MSC   | O (5) | 2    |
| Circuit Pool                | 3.2.2.45  | BSS-MSC   | O (2) | 2    |
| Speech Version (Chosen)     | 3.2.2.51  | BSS-MSC   | O (6) | 2    |
| Circuit Identity Code       | 3.2.2.2   | BSS-MSC   | O (3) | 3    |
| LSA Identifier              | 3.2.2.15  | BSS-MSC   | O (7) | 5    |

- 1 This information field carries a radio interface message. In case of Intersystem handover to UMTS the information field contains (on MAP-E interface) a HANDOVER TO UTRAN COMMAND message as defined in TS 25.331 In case of Inter BSC handover or in case of a Intersystem Handover from UTRAN to GSM a HANDOVER COMMAND as defined in TS 04.18. In case of a Intersystem Handover from cdma2000 a HANDOVER COMMAND as defined in TS 04.18. In case of Intersystem handover to cdma2000 the information field contains (on MAP-E interface) the Handover To cdma2000 Command, as defined in TS 04.18.
- 2 Shall be included when several circuit pools are present on the BSS MSC interface and a circuit was allocated by the HANDOVER REQUEST message.
- 3 The Circuit identity code information element is included mandatorily by the BSS if the BSS allocates the A interface circuits and a circuit is needed.
- 4 Included at least when the channel rate/type choice was done by the BSS.
- 5 Included at least when the encryption algorithm has been selected by the BSS.
- 6 Included at least when the speech version choice was done by the BSS.
- 7 Shall be included if a potential current LSA in the target cell has been identified (see 3GPP TS 43.073 [40]). Not included means that there is no potential current LSA in the target cell.

### 3.2.1.11 HANDOVER COMMAND

This message is sent from the MSC to the BSS via the relevant SCCP connection and contains the target channel to which the MS should retune.

| INFORMATION ELEMENT | REFERENCE | DIRECTION | TYPE  | LEN  |
|---------------------|-----------|-----------|-------|------|
| Message Type        | 3.2.2.1   | MSC-BSS   | M     | 1    |
| Layer 3 Information | 3.2.2.24  | MSC-BSS   | M (1) | 11-n |
| Cell Identifier     | 3.2.2.17  | MSC-BSS   | O     | 3-10 |

- 1 This information field carries a radio interface message. In case of Intersystem handover to UMTS the information field contains a HANDOVER TO UTRAN COMMAND message as defined in 3GPP TS 25.331 [33]. In case of Inter BSC handover a RR HANDOVER COMMAND as defined in 3GPP TS 44.018 [32]. In case of Intersystem handover to cdma2000 the information field contains the Handover To cdma2000 Command, as defined in 3GPP TS 44.018 [32].

### 3.2.1.12 HANDOVER COMPLETE

This message is sent from the BSS to the MSC via the relevant SCCP connection.

It indicates that the correct MS has successfully accessed the target cell.

| INFORMATION ELEMENT | REFERENCE | DIRECTION | TYPE | LEN |
|---------------------|-----------|-----------|------|-----|
| Message Type        | 3.2.2.1   | BSS-MSC   | M    | 1   |
| RR Cause            | 3.2.2.22  | BSS-MSC   | O    | 2   |

### 3.2.1.13 HANDOVER SUCCEEDED

This message is sent from the MSC to the old BSS via the relevant SCCP connection.

It indicates that the correct MS has successfully accessed the target cell.

| INFORMATION ELEMENT | REFERENCE | DIRECTION | TYPE | LEN |
|---------------------|-----------|-----------|------|-----|
| Message Type        | 3.2.2.1   | MSC-BSS   | M    | 1   |

### 3.2.1.14 HANDOVER CANDIDATE ENQUIRE

This message is sent from the MSC to the BSS, using the connectionless services of the SCCP.

| INFORMATION ELEMENT  | REFERENCE | DIRECTION | TYPE | LEN                |
|----------------------|-----------|-----------|------|--------------------|
| Message Type         | 3.2.2.1   | MSC-BSS   | M    | 1                  |
| Number Of Mss        | 3.2.2.8   | MSC-BSS   | M    | 2                  |
| Cell Identifier List | 3.2.2.27  | MSC-BSS   | M    | 2n+3<br>to<br>7n+3 |
| Cell Identifier      | 3.2.2.17  | MSC-BSS   | M    | 3-10               |

### 3.2.1.15 HANDOVER CANDIDATE RESPONSE

This message is sent from the BSS to the MSC in response to receipt of a HANDOVER CANDIDATE ENQUIRE message. It contains the number of MSs for which HANDOVER REQUIRED messages have been sent.

This message is sent as a connectionless SCCP message.

| INFORMATION ELEMENT | REFERENCE | DIRECTION | TYPE | LEN  |
|---------------------|-----------|-----------|------|------|
| Message Type        | 3.2.2.1   | BSS-MSC   | M    | 1    |
| Number Of Mss       | 3.2.2.8   | BSS-MSC   | M    | 2    |
| Cell Identifier     | 3.2.2.17  | BSS-MSC   | M    | 3-10 |

### 3.2.1.16 HANDOVER FAILURE

This message is sent from the BSS to the MSC via the relevant SCCP connection. It indicates to the MSC that there has been a failure in the resource allocation process on handover, and that the handover has been aborted.

| INFORMATION ELEMENT | REFERENCE | DIRECTION | TYPE  | LEN |
|---------------------|-----------|-----------|-------|-----|
| Message Type        | 3.2.2.1   | BSS-MSC   | M     | 1   |
| Cause               | 3.2.2.5   | BSS-MSC   | M     | 3-4 |
| RR Cause            | 3.2.2.22  | BSS-MSC   | O     | 2   |
| Circuit Pool        | 3.2.2.45  | BSS-MSC   | O (1) | 2   |
| Circuit Pool List   | 3.2.2.46  | BSS-MSC   | O (2) | V   |

- 1 Shall be included when several circuit pools are present on the BSS MSC interface.
- 2 May be included when cause is "circuit pool mismatch" or "switch circuit pool" to indicate circuit pool preferences.

Typical Cause values are:

radio interface message failure;  
 O and M intervention;  
 Equipment failure;  
 no radio resource available;  
 requested terrestrial resource unavailable;  
 requested transcoding/rate adaption unavailable;  
 terrestrial resource already allocated;  
 invalid message contents;  
 radio interface failure - reversion to old channel;  
 ciphering algorithm not supported;  
 circuit pool mismatch;  
 switch circuit pool;  
 requested speech version unavailable.

### 3.2.1.17 RESOURCE REQUEST

This message is sent from the MSC to the BSS and requests the current spare and optionally the total accessible resource on a particular cell.

This message is sent as a connectionless SCCP message.

| INFORMATION ELEMENT         | REFERENCE | DIRECTION | TYPE | LEN  |
|-----------------------------|-----------|-----------|------|------|
| Message Type                | 3.2.2.1   | MSC-BSS   | M    | 1    |
| Periodicity                 | 3.2.2.12  | MSC-BSS   | M    | 2    |
| Resource Indication Method  | 3.2.2.29  | MSC-BSS   | M    | 2    |
| Cell Identifier             | 3.2.2.17  | MSC-BSS   | M    | 3-10 |
| Extended Resource Indicator | 3.2.2.13  | MSC-BSS   | O    | 2    |

### 3.2.1.18 RESOURCE INDICATION

This message is sent from the BSS to the MSC in response to a resource request message, the message includes an explicit indication of the cell concerned.

This message is sent as a connectionless SCCP message.

| INFORMATION ELEMENT        | REFERENCE | DIRECTION | TYPE  | LEN  |
|----------------------------|-----------|-----------|-------|------|
| Message Type               | 3.2.2.1   | BSS-MSC   | M     | 1    |
| Resource Indication Method | 3.2.2.29  | BSS-MSC   | M     | 2    |
| Resource Available         | 3.2.2.4   | BSS-MSC   | O (1) | 21   |
| Cell Identifier            | 3.2.2.17  | BSS-MSC   | M     | 3-10 |
| Total Resource Accessible  | 3.2.2.14  | BSS-MSC   | O (2) | 5    |

- 1 This element is not included if the message is sent only as an acknowledgement to the reception of a RESOURCE REQUEST message.
- 2 This element has to be included if requested by the Extended Resource Indicator, except when the message is sent only as an acknowledgement to the reception of the RESOURCE REQUEST message.

### 3.2.1.19 PAGING

This message is sent from the MSC to the BSS and contains sufficient information to allow the paging message to be transmitted by the correct cells at the correct time.

This message is sent as a connectionless SCCP message.

| INFORMATION ELEMENT  | REFERENCE | DIRECTION | TYPE  | LEN             |
|----------------------|-----------|-----------|-------|-----------------|
| Message Type         | 3.2.2.1   | MSC-BSS   | M     | 1               |
| IMSI                 | 3.2.2.6   | MSC-BSS   | M     | 3-10            |
| TMSI                 | 3.2.2.7   | MSC-BSS   | O (1) | 6               |
| Cell Identifier List | 3.2.2.27  | MSC-BSS   | M     | 3<br>to<br>3+7n |
| Channel Needed       | 3.2.2.36  | MSC-BSS   | O (2) | 2               |
| eMLPP Priority       | 3.2.2.56  | MSC-BSS   | O (3) | 2               |

- 1 This element is omitted in the exceptional case where the IMSI is used instead of the TMSI as a paging address at the radio interface.
- 2 If the channel needed element is not present, the default value is assumed to be 00 (any channel).
- 3 If the BSS implements the eMLPP feature it should use this information element to build the radio interface Paging request messages, otherwise the information may be considered as an unrecognisable information element.

### 3.2.1.20 CLEAR REQUEST

This message is sent from the BSS to the MSC to indicate to the MSC that the BSS wishes to release the associated dedicated resource(s).

The message is sent via the BSSAP SCCP connection associated with the dedicated resource(s).

| INFORMATION ELEMENT | REFERENCE | DIRECTION | TYPE | LEN |
|---------------------|-----------|-----------|------|-----|
| Message Type        | 3.2.2.1   | BSS-MSC   | M    | 1   |
| Cause               | 3.2.2.5   | BSS-MSC   | M    | 3-4 |

Typical Cause values are:

radio interface message failure,  
O and M intervention,  
equipment failure,  
Joined group call channel,  
protocol error between BSS and MSC,  
preemption.

### 3.2.1.21 CLEAR COMMAND

This message is sent from the MSC to the BSS to instruct the BSS to release the associated dedicated resource(s).

The message is sent via the BSSAP SCCP connection associated with the dedicated resource(s).

| INFORMATION ELEMENT        | REFERENCE | DIRECTION | TYPE  | LEN |
|----------------------------|-----------|-----------|-------|-----|
| Message Type               | 3.2.2.1   | MSC-BSS   | M     | 1   |
| Layer 3 Header Information | 3.2.2.9   | MSC-BSS   | O (1) | 4   |
| Cause                      | 3.2.2.5   | MSC-BSS   | M     | 3-4 |

- 1 This information element doesn't serve any useful purpose. MSCs should not send the information element unless it is required by the recipients (due to the need to interwork with older versions of the protocol). It is expected that in future versions of 3GPP TS 48.008, this information element will be deleted from this message.

Typical Cause values are:

call control,  
O and M intervention,  
equipment failure,  
handover successful,  
protocol error between BSS and MSC.

### 3.2.1.22 CLEAR COMPLETE

This message is sent from the BSS to the MSC to inform the MSC that the associated dedicated resource(s) has been successfully cleared.

The message is sent via the BSSAP SCCP connection associated with the dedicated resource(s).

| INFORMATION ELEMENT | REFERENCE | DIRECTION | TYPE | LEN |
|---------------------|-----------|-----------|------|-----|
| Message Type        | 3.2.2.1   | BSS-MSC   | M    | 1   |

### 3.2.1.23 RESET

This message can be sent either from the BSS to the MSC or from the MSC to the BSS. It indicates to the receiving entity that the transmitting entity has suffered a failure and has lost memory of the calls in progress, calls set up, and associated references.

This message is sent as a connectionless SCCP message.

| INFORMATION ELEMENT | REFERENCE | DIRECTION | TYPE | LEN |
|---------------------|-----------|-----------|------|-----|
| Message Type        | 3.2.2.1   | Both      | M    | 1   |
| Cause               | 3.2.2.5   | Both      | M    | 3-4 |

Typical Cause values are:

O and M intervention,  
equipment failure.

### 3.2.1.24 RESET ACKNOWLEDGE

This message can be sent either from the BSS to the MSC or from the MSC to the BSS. It indicates to the receiving entity that the transmitting entity has cleared all calls and reset all references, and is ready to resume service.

This message is sent as a connectionless SCCP message.

| INFORMATION ELEMENT | REFERENCE | DIRECTION | TYPE | LEN |
|---------------------|-----------|-----------|------|-----|
| Message Type        | 3.2.2.1   | Both      | M    | 1   |



### 3.2.1.25 HANDOVER PERFORMED

This message is sent from the BSS to the MSC in order to indicate that the BSS has performed an internal handover.

The cell identifier and (if required for O and M reasons) optionally the new channel identity is included.

The message is sent via the BSSAP SCCP connection associated with the dedicated resource(s).

| INFORMATION ELEMENT         | REFERENCE | DIRECTION | TYPE  | LEN  |
|-----------------------------|-----------|-----------|-------|------|
| Message Type                | 3.2.2.1   | BSS-MSC   | M     | 1    |
| Cause                       | 3.2.2.5   | BSS-MSC   | M     | 3-4  |
| Cell Identifier             | 3.2.2.17  | BSS-MSC   | M (5) | 3-10 |
| Chosen Channel              | 3.2.2.33  | BSS-MSC   | O (1) | 2    |
| Chosen Encryption Algorithm | 3.2.2.44  | BSS-MSC   | O (2) | 2    |
| Speech Version (Chosen)     | 3.2.2.51  | BSS-MSC   | O (3) | 2    |
| LSA Identifier              | 3.2.2.15  | BSS-MSC   | O (4) | 5    |

- 1 Included at least when the channel rate/type has changed during the handover.
- 2 Included at least when the encryption algorithm has been changed by the BSS.
- 3 Included at least when the speech version has been changed by the BSS.
- 4 Shall be included if current LSA in the new serving cell has been identified (see 3GPP TS 43.073 [40]). Not included means that there is no current LSA in the new serving cell.
- 5 When sent from MSC-B over MAP/E interface this information element contains indication of Cell Identifier (e.g. CGI).  
When sent from 3G\_MSC-B over MAP/E interface this information element contains indication of Cell Identifier (e.g. CGI) if the handover target is GSM or indication of either RNC-ID or SAI (if known) if the handover target is UMTS (when indication of relocation complete is received from RNC) or indication of SAI when an indication of location report is received (intra UMTS relocation). Note; RNC-ID or SAI are only provided in the HANDOVER PERFORMED message over the MAP-E interface.

Typical Cause values: as for the handover required message, except response to MSC invocation.

### 3.2.1.26 OVERLOAD

This message is sent from the BSS to the MSC or from the MSC to the BSS. When sent from the BSS to the MSC it indicates either processor overload of the whole BSS (cell identifier field not present) or overload of a CCCH downlink in which case the relevant cell is identified.

This message is sent as a connectionless SCCP message.

| INFORMATION ELEMENT | REFERENCE | DIRECTION | TYPE | LEN  |
|---------------------|-----------|-----------|------|------|
| Message Type        | 3.2.2.1   | Both      | M    | 1    |
| Cause               | 3.2.2.5   | Both      | M    | 3-4  |
| Cell Identifier     | 3.2.2.17  | BSS-MSC   | O    | 3-10 |

Typical Cause values are:

- Processor overload,
- CCCH overload,
- O&M intervention.

### 3.2.1.27 MSC INVOKE TRACE

This message is sent from the MSC to the BSS in order to start production of a trace record at the BSS.

The message is sent via the BSSAP SCCP connection associated with the dedicated resource(s).

| INFORMATION ELEMENT | REFERENCE | DIRECTION | TYPE | LEN  |
|---------------------|-----------|-----------|------|------|
| Message Type        | 3.2.2.1   | MSC-BSS   | M    | 1    |
| Trace Type          | 3.2.2.37  | MSC-BSS   | M    | 2    |
| Triggerid           | 3.2.2.38  | MSC-BSS   | O    | 3-22 |
| Trace Reference     | 3.2.2.39  | MSC-BSS   | M    | 3    |
| Transactionid       | 3.2.2.40  | MSC-BSS   | O    | 4    |
| Mobile Identity     | 3.2.2.41  | MSC-BSS   | O    | 3-10 |
| OMCId               | 3.2.2.42  | MSC-BSS   | O    | 3-22 |

### 3.2.1.28 BSS INVOKE TRACE

This message is sent from the BSS to the MSC in order to start production of a trace record at the MSC and/or from the MSC to BSS to target BSSs after a handover.

The message is sent via the BSSAP SCCP connection associated with the dedicated resource(s).

| INFORMATION ELEMENT | REFERENCE | DIRECTION | TYPE | LEN  |
|---------------------|-----------|-----------|------|------|
| Message Type        | 3.2.2.1   | Both      | M    | 1    |
| Trace Type          | 3.2.2.37  | Both      | M    | 2    |
| Forward Indicator   | 3.2.2.43  | Both      | O    | 2    |
| Triggerid           | 3.2.2.38  | Both      | O    | 3-22 |
| Trace Reference     | 3.2.2.39  | Both      | M    | 3    |
| Transactionid       | 3.2.2.40  | Both      | O    | 4    |
| OMCId               | 3.2.2.42  | Both      | O    | 3-22 |

### 3.2.1.29 CLASSMARK UPDATE

This message is sent from the BSS to the MSC or from the MSC to the BSS via the relevant SCCP connection associated with that MS transaction. It updates the classmark parameters for the concerned MS.

| INFORMATION ELEMENT          | REFERENCE | DIRECTION | TYPE  | LEN  |
|------------------------------|-----------|-----------|-------|------|
| Message Type                 | 3.2.2.1   | Both      | M     | 1    |
| Classmark Information Type 2 | 3.2.2.19  | Both      | M     | 4-5  |
| Classmark Information Type 3 | 3.2.2.20  | Both      | O (1) | 3-14 |

- 1 This element shall be included by the BSS if it was received from the MS. It shall be included by the MSC if this information element has previously been received by the MSC.

### 3.2.1.30 CIPHER MODE COMMAND

This message is sent from the MSC to the BSS via the relevant SCCP connection associated with that MS transaction. It updates the encryption parameters for the concerned MS.

| INFORMATION ELEMENT        | REFERENCE | DIRECTION | TYPE  | LEN |
|----------------------------|-----------|-----------|-------|-----|
| Message Type               | 3.2.2.1   | MSC-BSS   | M     | 1   |
| Layer 3 Header Information | 3.2.2.9   | MSC-BSS   | O (1) | 4   |
| Encryption Information     | 3.2.2.10  | MSC-BSS   | M     | 3-n |
| Cipher Response Mode       | 3.2.2.34  | MSC-BSS   | O     | 2   |

- 1 This information element doesn't serve any useful purpose. MSCs should not send the information element unless it is required by the recipients (due to the need to interwork with older versions of the protocol). It is expected that in future versions of 48.008, this information element will be deleted from this message.

### 3.2.1.31 CIPHER MODE COMPLETE

This message is sent from the BSS to the MSC via the relevant SCCP connection. It indicates that a successful cipher synchronisation has been achieved across the radio interface.

| INFORMATION ELEMENT         | REFERENCE | DIRECTION | TYPE  | LEN |
|-----------------------------|-----------|-----------|-------|-----|
| Message Type                | 3.2.2.1   | BSS-MSC   | M     | 1   |
| Layer 3 Message Contents    | 3.2.2.35  | BSS-MSC   | O     | 2-n |
| Chosen Encryption Algorithm | 3.2.2.44  | BSS-MSC   | O (1) | 2   |

- 1 Included at least when the encryption algorithm has been selected by the BSS.

### 3.2.1.32 COMPLETE LAYER 3 INFORMATION

The message is sent from the BSS to the MSC as described in subclause 3.1.16 (on receipt of the initial layer 3 message on a dedicated channel, e.g. PAGING RESPONSE, LOCATION UPDATING REQUEST, CM REESTABLISHMENT REQUEST, CM SERVICE REQUEST, IMSI DETACH, IMMEDIATE SETUP).

The message is sent via the BSSAP SCCP connection established for the associated dedicated resource(s).

| INFORMATION ELEMENT | REFERENCE | DIRECTION | TYPE  | LEN    |
|---------------------|-----------|-----------|-------|--------|
| Message Type        | 3.2.2.1   | BSS-MSC   | M     | 1      |
| Cell Identifier     | 3.2.2.17  | BSS-MSC   | M     | 3 - 10 |
| Layer 3 Information | 3.2.2.24  | BSS-MSC   | M     | 3 - n  |
| Chosen Channel      | 3.2.2.33  | BSS-MSC   | O (1) | 2      |
| LSA Identifier List | 3.2.2.16  | BSS-MSC   | O (2) | 3 + 3n |
| PADU                | 3.2.2.68  | BSS-MSC   | O (3) | 3 - n  |

- 1 This element is optionally used by the BSS to give the MSC a description of the channel rate/type on which the initial layer 3 message was received.
- 2 This element shall be included at least when the current cell belongs to one or more LSAs.
- 3 This element is optionally used by the BSS to provide Location Services related information to MSC.

### 3.2.1.33 QUEUEING INDICATION

This message is sent from the BSS to the MSC in order to indicate a delay in the assignment of the required TCH.

The message is sent via the BSSAP SCCP connection associated with the dedicated resource(s).

| INFORMATION ELEMENT | REFERENCE | DIRECTION | TYPE | LEN |
|---------------------|-----------|-----------|------|-----|
| Message Type        | 3.2.2.1   | MSC-BSS   | M    | 1   |

### 3.2.1.34 SAPI "n" REJECT

This message is sent from the BSS to the MSC in order to indicate that a message with a SAPI value other than "0" has been rejected.

The message is sent via the BSSAP SCCP connection associated with the dedicated resource(s).

| INFORMATION ELEMENT | REFERENCE | DIRECTION | TYPE | LEN |
|---------------------|-----------|-----------|------|-----|
| Message Type        | 3.2.2.1   | BSS-MSC   | M    | 1   |
| DLCI                | 3.2.2.25  | BSS-MSC   | M    | 2   |
| Cause               | 3.2.2.5   | BSS-MSC   | M    | 3-4 |

Typical Cause values are:

O&M intervention,  
processor overload,  
BSS not equipped,  
MS not equipped.

3.2.1.35 Void

3.2.1.36 Void

### 3.2.1.37 HANOVER REQUIRED REJECT

This message is sent from the MSC to the BSS via the relevant SCCP connection. It indicates to the BSS that the HANOVER REQUIRED message has not resulted in handover.

| INFORMATION ELEMENT | REFERENCE | DIRECTION | TYPE | LEN |
|---------------------|-----------|-----------|------|-----|
| Message Type        | 3.2.2.1   | MSC-BSS   | M    | 1   |
| Cause               | 3.2.2.5   | MSC-BSS   | M    | 3-4 |

Typical Cause values are:

equipment failure,  
no radio resource available,  
requested terrestrial resource unavailable,  
invalid message contents,  
requested transcoding/rate adaptation unavailable,  
O and M intervention.

### 3.2.1.38 RESET CIRCUIT

This message is sent either from the BSS to the MSC or from the MSC to the BSS. It indicates to the receiving entity that the state of the circuit indicated in the message is unknown, due to a failure.

This message is sent as a SCCP connectionless message.

| INFORMATION ELEMENT   | REFERENCE | DIRECTION | TYPE | LEN |
|-----------------------|-----------|-----------|------|-----|
| Message Type          | 3.2.2.1   | Both      | M    | 1   |
| Circuit Identity Code | 3.2.2.2   | Both      | M    | 3   |
| Cause                 | 3.2.2.5   | Both      | M    | 3-4 |

Typical Cause values are: as for the RESET message.

### 3.2.1.39 RESET CIRCUIT ACKNOWLEDGE

This message is sent either from the BSS to the MSC or from the MSC to the BSS. It indicates to the receiving entity that the transmitting entity has cleared a possible call using the circuit, and is ready to resume service.

This message is sent as a connectionless SCCP message.

| INFORMATION ELEMENT | REFERENCE | DIRECTION | TYPE | LEN |
|---------------------|-----------|-----------|------|-----|
| Message Type        | 3.2.2.1   | Both      | M    | 1   |
| Circuit Identity    | 3.2.2.2   | Both      | M    | 3   |

### 3.2.1.40 HANOVER DETECT

This message is sent from the BSS to the MSC via the relevant SCCP connection. It indicates that the correct MS has successfully accessed the target cell.

| INFORMATION ELEMENT | REFERENCE | DIRECTION | TYPE | LEN |
|---------------------|-----------|-----------|------|-----|
| Message Type        | 3.2.2.1   | BSS-MSC   | M    | 1   |

### 3.2.1.41 CIRCUIT GROUP BLOCK

This message is sent from the BSS to the MSC or from the MSC to the BSS to indicate that a set of terrestrial resources (ie some timeslots within a system of 2Mbit PCM multiplex) must be remotely blocked at the circuit master, and cannot therefore be used for traffic.

This message is sent as a connectionless SCCP message.

| INFORMATION ELEMENT        | REFERENCE | DIRECTION | TYPE | LEN  |
|----------------------------|-----------|-----------|------|------|
| Message Type               | 3.2.2.1   | both      | M    | 1    |
| Cause                      | 3.2.2.5   | both      | M    | 3-4  |
| Circuit Identity Code      | 3.2.2.2   | both      | M    | 3    |
| Circuit Identity Code List | 3.2.2.31  | both      | M    | 4-35 |

Typical Cause values:

O & M intervention,  
equipment failure.

### 3.2.1.42 CIRCUIT GROUP BLOCKING ACKNOWLEDGE

This message is sent from the MSC to the BSS or from the BSS to the MSC to acknowledge the receipt of an earlier CIRCUIT GROUP BLOCK message, and to indicate that the circuits indicated in the status subfield of the Circuit Identity Code List have been remotely blocked.

This message is sent as a connectionless SCCP message.

| INFORMATION ELEMENT        | REFERENCE | DIRECTION | TYPE | LEN  |
|----------------------------|-----------|-----------|------|------|
| Message Type               | 3.2.2.1   | both      | M    | 1    |
| Circuit Identity Code      | 3.2.2.2   | both      | M    | 3    |
| Circuit Identity Code List | 3.2.2.31  | both      | M    | 4-35 |

### 3.2.1.43 CIRCUIT GROUP UNBLOCK

This message is sent from the BSS to the MSC or from the MSC to the BSS to indicate that a set of terrestrial resources (ie some timeslots within a system of 2Mbit PCM multiplex) may be returned to service at the circuit master.

This message is sent as a connectionless SCCP message.

| INFORMATION ELEMENT        | REFERENCE | DIRECTION | TYPE | LEN  |
|----------------------------|-----------|-----------|------|------|
| Message Type               | 3.2.2.1   | both      | M    | 1    |
| Circuit Identity Code      | 3.2.2.2   | both      | M    | 3    |
| Circuit Identity Code List | 3.2.2.31  | both      | M    | 4-35 |

### 3.2.1.44 CIRCUIT GROUP UNBLOCKING ACKNOWLEDGE

This message is sent from the MSC to the BSS or from the MSC to the BSS to acknowledge the receipt of an earlier CIRCUIT GROUP UNBLOCK message, and to indicate that the circuits indicated in the status subfield of the Circuit Identity Code List are remotely unblocked.

This message is sent as a connectionless SCCP message.

| INFORMATION ELEMENT        | REFERENCE | DIRECTION | TYPE | LEN  |
|----------------------------|-----------|-----------|------|------|
| Message Type               | 3.2.2.1   | both      | M    | 1    |
| Circuit Identity Code      | 3.2.2.2   | both      | M    | 3    |
| Circuit Identity Code List | 3.2.2.31  | both      | M    | 4-35 |

### 3.2.1.45 CONFUSION

This message is sent in either direction in response to a message which cannot be treated correctly for some reason, and for which another failure message cannot substitute. The use of this message may be under operator control.

| INFORMATION ELEMENT | REFERENCE | DIRECTION | TYPE | LEN |
|---------------------|-----------|-----------|------|-----|
| Message Type        | 3.2.2.1   | Both      | M    | 1   |
| Cause               | 3.2.2.5   | Both      | M    | 3-4 |
| Diagnostics         | 3.2.2.32  | Both      | M    | 4-n |

Typical Cause values are:

Invalid message contents;  
 information element or field missing;  
 incorrect value;  
 unknown message type;  
 unknown information element;  
 protocol error between BSS and MSC; and  
 invalid cell.

### 3.2.1.46 CLASSMARK REQUEST

This message is sent from the MSC to the BSS via the relevant SCCP connection associated with that MS transaction. It requests an update of the classmark parameters for the concerned MS.

| INFORMATION ELEMENT | REFERENCE | DIRECTION | TYPE | LEN |
|---------------------|-----------|-----------|------|-----|
| Message Type        | 3.2.2.1   | MSC-BSS   | M    | 1   |

### 3.2.1.47 UNEQUIPPED CIRCUIT

This message is sent from the BSS to the MSC or vice versa to indicate to the partner entity that it is utilising one or several circuit identity codes which are unknown and which therefore should be locally blocked immediately and taken out of service.

This message is sent as a connectionless SCCP message.

| INFORMATION ELEMENT        | REFERENCE | DIRECTION | TYPE | LEN  |
|----------------------------|-----------|-----------|------|------|
| Message Type               | 3.2.2.1   | Both      | M    | 1    |
| Circuit Identity Code      | 3.2.2.2   | Both      | M    | 3    |
| Circuit Identity Code List | 3.2.2.31  | Both      | O    | 4-35 |

### 3.2.1.48 CIPHER MODE REJECT

This message is sent from the BSS to the MSC via the relevant SCCP connection associated with that MS transaction. It indicates that the BSS is unable to perform the requested ciphering.

| INFORMATION ELEMENT | REFERENCE | DIRECTION | TYPE | LEN |
|---------------------|-----------|-----------|------|-----|
| Message Type        | 3.2.2.1   | BSS-MSC   | M    | 1   |
| Cause               | 3.2.2.5   | BSS-MSC   | M    | 3-4 |

Typical Cause values are:

Ciphering algorithm not supported,  
 Invalid message contents

### 3.2.1.49 LOAD INDICATION

The LOAD INDICATION message is sent from the BSS to the MSC and from the MSC to the BSS. It indicates to the receiving entity that the transmitting BSS has detected a load situation in the concerned cell.

This message is sent as a connectionless SCCP message.

| INFORMATION ELEMENT           | REFERENCE | DIRECTION | TYPE  | LEN             |
|-------------------------------|-----------|-----------|-------|-----------------|
| Message Type                  | 3.2.2.1   | Both      | M     | 1               |
| Time Indication               | 3.2.2.47  | Both      | M     | 2               |
| Cell Identifier               | 3.2.2.17  | Both      | M     | 3-10            |
| Cell Identifier List (Target) | 3.2.2.27  | Both      | M     | 3<br>to<br>3+7n |
| Resource Situation            | 3.2.2.48  | Both      | O (1) | 4-N             |
| Cause                         | 3.2.2.5   | Both      | O (2) | 4-5             |

Typical Cause values:

- O & M intervention
- Equipment failure
- No radio resource available
- Processor overload
- Traffic load

- 1 This information element can only be omitted, if the sending BSS wants to stop the whole incoming handover traffic to the indicated cell.
- 2 Included at least when the reason for sending this message is other than traffic load.

### 3.2.1.50 VGCS/VBS SETUP

This message is sent from the MSC to the BSS via the newly created SCCP connection in order to request the BSS to support a VGCS/VBS call.

| INFORMATION ELEMENT  | REFERENCE | DIRECTION | TYPE | LEN |
|----------------------|-----------|-----------|------|-----|
| Message Type         | 3.2.2.1   | MSC-BSS   | M    | 1   |
| Group Call Reference | 3.2.2.55  | MSC-BSS   | M    | 3-8 |
| Priority             | 3.2.2.18  | MSC-BSS   | O    | 3   |

### 3.2.1.51 VGCS/VBS SETUP ACK

This message is sent from the BSS to the MSC via the newly created SCCP connection in order to confirm that the BSS will support the VGCS/VBS call.

| INFORMATION ELEMENT | REFERENCE | DIRECTION | TYPE | LEN |
|---------------------|-----------|-----------|------|-----|
| Message Type        | 3.2.2.1   | BSS-MSC   | M    | 1   |

### 3.2.1.52 VGCS/VBS SETUP REFUSE

This message is sent from the BSS to the MSC via the newly created SCCP connection in order to reject the SETUP of the VGCS/VBS call.

| INFORMATION ELEMENT | REFERENCE | DIRECTION | TYPE | LEN |
|---------------------|-----------|-----------|------|-----|
| Message Type        | 3.2.2.1   | BSS-MSC   | M    | 1   |
| Cause               | 3.2.2.5   | BSS-MSC   | M    | 3-4 |

### 3.2.1.53 VGCS/VBS ASSIGNMENT REQUEST

This message is sent from the MSC to the BSS via the newly created VGCS/VBS resource controlling SCCP connection in order to request the BSS to assign radio resources in a cell to support a VGCS/VBS call.

| INFORMATION ELEMENT    | REFERENCE | DIRECTION | TYPE | LEN  |
|------------------------|-----------|-----------|------|------|
| Message Type           | 3.2.2.1   | MSC-BSS   | M    | 1    |
| Channel Type           | 3.2.2.11  | MSC-BSS   | M    | 5    |
| Assignment Requirement | 3.2.2.52  | MSC-BSS   | M    | 2    |
| Cell Identifier        | 3.2.2.17  | MSC-BSS   | M    | 3-10 |
| Group Call Reference   | 3.2.2.55  | MSC-BSS   | M    | 3-8  |
| Priority               | 3.2.2.18  | MSC-BSS   | O    | 3    |
| Circuit Identity Code  | 3.2.2.2   | MSC-BSS   | O    | 3    |
| Downlink DTX Flag      | 3.2.2.26  | MSC-BSS   | O    | 2    |
| Encryption Information | 3.2.2.10  | MSC-BSS   | O    | 3-n  |

### 3.2.1.54 VGCS/VBS ASSIGNMENT RESULT

The VGCS/VBS ASSIGNMENT RESULT message when received indicates the assignment/deassignment of radio resource for the indicated cell.

The message is sent by the BSS via the BSSAP VGCS/VBS resource controlling SCCP connection associated with the dedicated resource.

| INFORMATION ELEMENT   | REFERENCE | DIRECTION | TYPE  | LEN  |
|-----------------------|-----------|-----------|-------|------|
| Message Type          | 3.2.2.1   | BSS-MSC   | M     | 1    |
| Channel Type          | 3.2.2.11  | BSS-MSC   | M (3) | 5    |
| Cell Identifier       | 3.2.2.17  | BSS-MSC   | M     | 3-10 |
| Chosen Channel        | 3.2.2.33  | BSS-MSC   | O (2) | 2    |
| Circuit Identity Code | 3.2.2.2   | BSS-MSC   | O     | 3    |
| Circuit Pool          | 3.2.2.45  | BSS-MSC   | O (1) | 2    |

- 1 Shall be included when several circuit pools are present on the BSS-MSC interface and a circuit was allocated by the ASSIGNMENT REQUEST message.
- 2 Included at least when the channel choice was done by the BSS.
- 3 Included even if BSS does not allocate radio resource immediately or de-allocate radio resource following VBS/VGCS uplink reply procedure.

### 3.2.1.55 VGCS/VBS ASSIGNMENT FAILURE

The VGCS/VBS ASSIGNMENT FAILURE message is sent from the BSS to the MSC via the relevant VGCS/VBS resource controlling SCCP connection. It indicates that there has been a failure in an assignment process at the BSS and that the VGCS/VBS Assignment procedure has been aborted for the concerned cell.

| INFORMATION ELEMENT | REFERENCE | DIRECTION | TYPE  | LEN |
|---------------------|-----------|-----------|-------|-----|
| Message Type        | 3.2.2.1   | BSS-MSC   | M     | 1   |
| Cause               | 3.2.2.5   | BSS-MSC   | M     | 3-4 |
| Circuit Pool        | 3.2.2.45  | BSS-MSC   | O (1) | 2   |
| Circuit Pool List   | 3.2.2.46  | BSS-MSC   | O (2) | V   |

- 1 Shall be included when several circuit pools are present on the BSS-MSC interface.
- 2 May be included when cause is "circuit pool mismatch" or "switch circuit pool" to indicate circuit pool preferences.



Typical Cause values are:

VGCS/VBS call non existent  
 O and M intervention,  
 equipment failure,  
 no radio resource available,  
 requested terrestrial resource unavailable,  
 requested transcoding/rate adaptation unavailable,  
 terrestrial resource already allocated,  
 invalid message contents,  
 circuit pool mismatch,  
 switch circuit pool,  
 ciphering algorithm not supported.

### 3.2.1.56 VGCS/VBS QUEUING INDICATION

The VGCS/VBS QUEUING INDICATION message is sent from the BSS to the MSC via the relevant VGCS/VBS resource controlling SCCP connection. It indicates that there is a delay in the assignment of radio resources for the cell.

| INFORMATION ELEMENT | REFERENCE | DIRECTION | TYPE | LEN |
|---------------------|-----------|-----------|------|-----|
| Message Type        | 3.2.2.1   | BSS-MSC   | M    | 1   |

### 3.2.1.57 UPLINK REQUEST

This message is sent from the BSS to the MSC in order to indicate that a mobile has requested to access the uplink of a voice group call channel.

| INFORMATION ELEMENT | REFERENCE | DIRECTION | TYPE | LEN |
|---------------------|-----------|-----------|------|-----|
| Message Type        | 3.2.2.1   | BSS-MSC   | M    | 1   |

### 3.2.1.58 UPLINK REQUEST ACKNOWLEDGE

This message is sent from the MSC to the BSS in order to indicate to the BSS that the uplink allocation of the voice group call channel has been granted by the MSC.

| INFORMATION ELEMENT | REFERENCE | DIRECTION | TYPE | LEN |
|---------------------|-----------|-----------|------|-----|
| Message Type        | 3.2.2.1   | MSC-BSS   | M    | 1   |

### 3.2.1.59 UPLINK REQUEST CONFIRMATION

This message is sent from the BSS to the MSC in order to indicate to the MSC that the uplink of the voice group call channel has been successfully established.

| INFORMATION ELEMENT | REFERENCE | DIRECTION | TYPE | LEN  |
|---------------------|-----------|-----------|------|------|
| Message Type        | 3.2.2.1   | BSS-MSC   | M    | 1    |
| Cell Identifier     | 3.2.2.17  | BSS-MSC   | M    | 3-10 |
| Layer 3 Information | 3.2.2.24  | BSS-MSC   | M    | 3-n  |

### 3.2.1.60 UPLINK RELEASE INDICATION

This message is sent from the BSS to the MSC in order to indicate to the MSC that the uplink of the voice group call channel has been released.

| INFORMATION ELEMENT | REFERENCE | DIRECTION | TYPE | LEN |
|---------------------|-----------|-----------|------|-----|
| Message Type        | 3.2.2.1   | BSS-MSC   | M    | 1   |
| Cause               | 3.2.2.5   | BSS-MSC   | M    | 3-4 |

Typical cause values

- radio interface message failure
- Call control
- O and M intervention

### 3.2.1.61 UPLINK REJECT COMMAND

This message is sent from the MSC to the BSS in order to indicate to the BSS that the uplink of the voice group call channel is not available for allocation to mobiles that have requested the use of the uplink.

| INFORMATION ELEMENT | REFERENCE | DIRECTION | TYPE | LEN |
|---------------------|-----------|-----------|------|-----|
| Message Type        | 3.2.2.1   | MSC-BSS   | M    | 1   |
| Cause               | 3.2.2.5   | MSC-BSS   | M    | 3-4 |

Typical cause values

- radio interface message failure
- Call control
- O and M intervention

### 3.2.1.62 UPLINK RELEASE COMMAND

This message is sent from the MSC to the BSS in order to indicate to the BSS that the uplink of the voice group call channel is available for allocation.

| INFORMATION ELEMENT | REFERENCE | DIRECTION | TYPE | LEN |
|---------------------|-----------|-----------|------|-----|
| Message Type        | 3.2.2.1   | MSC-BSS   | M    | 1   |
| Cause               | 3.2.2.5   | MSC-BSS   | M    | 3-4 |

Typical cause values

- Call control
- Invalid cell (in case the talker has left the Group Call Area)

### 3.2.1.63 UPLINK SEIZED COMMAND

This message is sent from the MSC to the BSS in order to indicate to the BSS that the uplink of the voice group call channel is no longer available for allocation.

| INFORMATION ELEMENT | REFERENCE | DIRECTION | TYPE | LEN |
|---------------------|-----------|-----------|------|-----|
| Message Type        | 3.2.2.1   | MSC-BSS   | M    | 1   |
| Cause               | 3.2.2.5   | MSC-BSS   | M    | 3-4 |

Typical cause values

- Call control

### 3.2.1.64 SUSPEND

The SUSPEND message is sent from the BSS to the MSC on the SCCP connection associated to an MS transaction. It indicates to the receiving entity that the transmitting BSS has detected an overload situation in the corresponding connection.

| INFORMATION ELEMENT | REFERENCE | DIRECTION | TYPE | LEN |
|---------------------|-----------|-----------|------|-----|
| Message Type        | 3.2.2.1   | BSS-MSC   | M    | 1   |
| DLCI                | 3.2.2.25  | BSS-MSC   | M    | 2   |

NOTE: The SUSPEND message may be only useful for PDSS1.

### 3.2.1.65 RESUME

The RESUME message is sent from the BSS to the MSC on the SCCP connection associated to an MS transaction. It indicates to the receiving entity that the overload situation in the corresponding connection does no more exist.

| INFORMATION ELEMENT | REFERENCE | DIRECTION | TYPE | LEN |
|---------------------|-----------|-----------|------|-----|
| Message Type        | 3.2.2.1   | BSS-MSC   | M    | 1   |
| DLCI                | 3.2.2.25  | BSS-MSC   | M    | 2   |

NOTE: The RESUME message may be only useful for PDSS1.

### 3.2.1.66 CHANGE CIRCUIT

This message is sent from the MSC to the BSS. It requests a change of the circuit allocated to a connection.

This message is sent on the relevant SCCP connection.

| INFORMATION ELEMENT | REFERENCE | DIRECTION | TYPE | LEN |
|---------------------|-----------|-----------|------|-----|
| Message Type        | 3.2.2.1   | MSC-BSS   | M    | 1   |
| Cause               | 3.2.2.5   | MSC-BSS   | M    | 3-4 |

Typical Cause values are

- Requested terrestrial resource unavailable,
- Terrestrial circuit already allocated.

### 3.2.1.67 CHANGE CIRCUIT ACKNOWLEDGE

This message is sent from the BSS to the MSC .It allocates a new circuit.

This message is sent on the relevant SCCP connection.

| INFORMATION ELEMENT | REFERENCE | DIRECTION | TYPE | LEN |
|---------------------|-----------|-----------|------|-----|
| Message Type        | 3.2.2.1   | BSS-MSC   | M    | 1   |
| Circuit identity    | 3.2.2.2   | BSS-MSC   | M    | 3   |

### 3.2.1.68 Common ID

This message is sent from the MSC to the BSS in order to inform the BSS of the IMSI associated with this SCCP connection.

This message is sent over the relevant SCCP connection, or, in the SCCP Connection Confirm message.

| INFORMATION ELEMENT | REFERENCE | DIRECTION | TYPE | LEN  |
|---------------------|-----------|-----------|------|------|
| Message Type        | 3.2.2.1   | MSC-BSS   | M    | 1    |
| IMSI                | 3.2.2.6   | MSC-BSS   | M    | 3-10 |

### 3.2.1.69 LSA INFORMATION

This message is sent from the MSC to the BSS via the relevant SCCP connection in order to inform the BSS as to which LSA identities the mobile subscriber has subscription.

| INFORMATION ELEMENT | REFERENCE | DIRECTION | TYPE | LEN  |
|---------------------|-----------|-----------|------|------|
| Message Type        | 3.2.2.1   | MSC-BSS   | M    | 1    |
| LSA Information     | 3.2.2.23  | MSC-BSS   | M    | 3+4n |

## 3.2.1.70 Void

## 3.2.1.71 PERFORM LOCATION REQUEST

This message is sent from the serving MSC to BSS via the relevant SCCP connection. It indicates to the receiving entity that actions related to Location Services needs to be performed.

| INFORMATION ELEMENT          | REFERENCE | TYPE  | LEN  |
|------------------------------|-----------|-------|------|
| Message Type                 | 3.2.2.1   | M     | 1    |
| Location Type                | 3.2.2.63  | M     | 3-n  |
| Cell Identifier              | 3.2.2.17  | O     | 5-10 |
| Classmark Information Type 3 | 3.2.2.20  | O     | 3-14 |
| LCS Client Type              | 3.2.2.67  | C (3) | 3-n  |
| Chosen Channel               | 3.2.2.33  | O     | 2    |
| LCS Priority                 | 3.2.2.62  | O     | 3-n  |
| LCS QoS                      | 3.2.2.60  | C (1) | 3-n  |
| GPS Assistance Data          | 3.2.2.70  | C (2) | 3-n  |
| APDU                         | 3.2.2.68  | O     | 3-n  |

- 1 The IE is present if location of the target MS is requested.
- 2 The IE is present if the GPS assistance data is requested.
- 3 The IE is present if the location type indicates a request for a location estimate and is optional otherwise.

## 3.2.1.72 PERFORM LOCATION RESPONSE

This message is sent from the serving BSS to the MSC via the relevant SCCP connection in response to the PERFORM LOCATION REQUEST. It contains information related to result of positioning of the target MS.

| INFORMATION ELEMENT | REFERENCE | TYPE  | LEN |
|---------------------|-----------|-------|-----|
| Message Type        | 3.2.2.1   | M     | 1   |
| Location Estimate   | 3.2.2.64  | C (1) | 3-n |
| Positioning Data    | 3.2.2.65  | O     | 3-n |
| Deciphering Keys    | 3.2.2.71  | C (2) | 3-n |
| LCS Cause           | 3.2.2.66  | C (3) | 3-n |

- 1 The IE is present if location of the target MS was requested and the procedure succeeded.
- 2 These IEs are present if deciphering key was requested and the procedure succeeded
- 3 The IE is present if the procedure failed.

## 3.2.1.73 PERFORM LOCATION ABORT

This message is sent from the serving MSC to BSS via the relevant SCCP connection. It indicates to the receiving entity that actions related to Location Services needs to be aborted.

| INFORMATION ELEMENT | REFERENCE | TYPE | LEN |
|---------------------|-----------|------|-----|
| Message Type        | 3.2.2.1   | M    | 1   |
| LCS Cause           | 3.2.2.66  | M    | 3-n |

## 3.2.1.74 CONNECTIONLESS INFORMATION

This message is sent from the BSS to the MSC or from the MSC to the BSS. The MSC forwards the CONNECTIONLESS INFORMATION message to the BSS as to which cell is indicated in the message. The message is sent as a connectionless SCCP message.

| INFORMATION ELEMENT               | REFERENCE | DIRECTION | TYPE  | LEN   |
|-----------------------------------|-----------|-----------|-------|-------|
| Message Type                      | 3.2.2.1   | Both      | M     | 1     |
| Network Element Identity (source) | 3.2.2.69  | Both      | M     | 3 - n |
| Network Element Identity (target) | 3.2.2.69  | Both      | M     | 3 - n |
| APDU                              | 3.2.2.68  | Both      | M     | 3 - n |
| Segmentation                      | 3.2,2,74  | Both      | C (1) | 5     |
| Return Error Request              | 3.2.2.72  | Both      | C (2) | 3 - n |
| Return Error Cause                | 3.2.2.73  | Both      | C (3) | 3 - n |

- 1 This IE is present if and only if the APDU contains a message segment.
- 2 The IE is present when the source of a message requests for an error response if the message cannot be delivered to its final destination. If this IE is present, then Return Error Cause shall not be present.
- 3 The IE is present when an error is indicated that the message was not delivered to its final destination. If this IE is present, then Return Error Request shall not be present. Refer to 3GPP TS 49.031 [19a] for cause values

### 3.2.2 Signalling element coding

This paragraph contains the CODING of the signalling elements used.

The following conventions are assumed for the sequence of transmission of bits and bytes:

- Each bit position is marked as 1 to 8. Bit 1 is the least significant bit and is transmitted first.
- In an element octets are identified by number, octet 1 is transmitted first, then octet 2, etc.

When a field extends over more than one octet, the order of bit values progressively decreases as the octet number increases. The least significant bit of the field is represented by the lowest numbered bit of the highest numbered octet of the field.

- For variable length elements a length indicator is included, this indicates the number of octets following in the element.
- All fields within Information Elements are mandatory unless otherwise specified. The Information Element Identifier shall always be included.

All spare bits are set to 0.

**Table: Signalling elements used and their CODING**

| Element Identifier Coding | Element name                 | Reference |
|---------------------------|------------------------------|-----------|
| 0000 0001                 | Circuit Identity Code        | 3.2.2.2   |
| 0000 0010                 | Reserved                     | *         |
| 0000 0011                 | Resource Available           | 3.2.2.4   |
| 0000 0100                 | Cause                        | 3.2.2.5   |
| 0000 0101                 | Cell Identifier              | 3.2.2.17  |
| 0000 0110                 | Priority                     | 3.2.2.18  |
| 0000 0111                 | Layer 3 Header Information   | 3.2.2.9   |
| 0000 1000                 | IMSI                         | 3.2.2.6   |
| 0000 1001                 | TMSI                         | 3.2.2.7   |
| 0000 1010                 | Encryption Information       | 3.2.2.10  |
| 0000 1011                 | Channel Type                 | 3.2.2.11  |
| 0000 1100                 | Periodicity                  | 3.2.2.12  |
| 0000 1101                 | Extended Resource Indicator  | 3.2.2.13  |
| 0000 1110                 | Number Of MSs                | 3.2.2.8   |
| 0000 1111                 | Reserved                     | *         |
| 0001 0000                 | Reserved                     | *         |
| 0001 0001                 | Reserved                     | *         |
| 0001 0010                 | Classmark Information Type 2 | 3.2.2.19  |
| 0001 0011                 | Classmark Information Type 3 | 3.2.2.20  |
| 0001 0100                 | Interference Band To Be Used | 3.2.2.21  |
| 0001 0101                 | RR Cause                     | 3.2.2.22  |
| 0001 0110                 | Reserved                     | *         |
| 0001 0111                 | Layer 3 Information          | 3.2.2.24  |
| 0001 1000                 | DLCI                         | 3.2.2.25  |
| 0001 1001                 | Downlink DTX Flag            | 3.2.2.26  |
| 0001 1010                 | Cell Identifier List         | 3.2.2.27  |
| 0001 1011                 | Response Request             | 3.2.2.28  |
| 0001 1100                 | Resource Indication Method   | 3.2.2.29  |
| 0001 1101                 | Classmark Information Type 1 | 3.2.2.30  |
| 0001 1110                 | Circuit Identity Code List   | 3.2.2.31  |
| 0001 1111                 | Diagnostic                   | 3.2.2.32  |
| 0010 0000                 | Layer 3 Message Contents     | 3.2.2.35  |
| 0010 0001                 | Chosen Channel               | 3.2.2.33  |
| 0010 0010                 | Total Resource Accessible    | 3.2.2.14  |
| 0010 0011                 | Cipher Response Mode         | 3.2.2.34  |
| 0010 0100                 | Channel Needed               | 3.2.2.36  |
| 0010 0101                 | Trace Type                   | 3.2.2.37  |
| 0010 0110                 | Triggerid                    | 3.2.2.38  |
| 0010 0111                 | Trace Reference              | 3.2.2.39  |
| 0010 1000                 | Transactionid                | 3.2.2.40  |
| 0010 1001                 | Mobile Identity              | 3.2.2.41  |
| 0010 1010                 | OMCId                        | 3.2.2.42  |
| 0010 1011                 | Forward Indicator            | 3.2.2.43  |
| 0010 1100                 | Chosen Encryption Algorithm  | 3.2.2.44  |
| 0010 1101                 | Circuit Pool                 | 3.2.2.45  |
| 0010 1110                 | Circuit Pool List            | 3.2.2.46  |
| 0010 1111                 | Time Indication              | 3.2.2.47  |
| 0011 0000                 | Resource Situation           | 3.2.2.48  |
| 0011 0001                 | Current Channel type 1       | 3.2.2.49  |
| 0011 0010                 | Queueing Indicator           | 3.2.2.50  |

| Element Identifier Coding | Element name  | Reference |
|---------------------------|---|-----------|
| 0100 0000                 | Speech Version  | 3.2.2.51  |
| 0011 0011                 | Assignment Requirement                                      | 3.2.2.52  |
| 0011 0101                 | Talker Flag   | 3.2.2.54  |
| 0011 0110                 | Connection Release Requested                                | 3.2.2.3   |
| 0011 0111                 | Group Call Reference  | 3.2.2.55  |
| 0011 1000                 | eMLPP Priority  | 3.2.2.56  |
| 0011 1001                 | Configuration Evolution Indication                          | 3.2.2.57  |
| 0011 1010                 | Old BSS to New BSS Information                              | 3.2.2.58  |
| 0011 1011                 | LSA Identifier  | 3.2.2.15  |
| 0011 1100                 | LSA Identifier List   | 3.2.2.16  |
| 0011 1101                 | LSA Information   | 3.2.2.23  |
| 0011 1110                 | LCS QoS   | 3.2.2.60  |
| 0011 1111                 | LSA access control suppression                              | 3.2.2.61  |
| 0100 0011                 | LCS Priority  | 3.2.2.62  |
| 0100 0100                 | Location Type   | 3.2.2.63  |
| 0100 0101                 | Location Estimate   | 3.2.2.64  |
| 0100 0110                 | Positioning Data  | 3.2.2.65  |
| 0100 0111                 | LCS Cause   | 3.2.2.66  |
| 0100 1000                 | LCS Client Type   | 3.2.2.67  |
| 0100 1001                 | APDU  | 3.2.2.68  |
| 0100 1010                 | Network Element Identity                                    | 3.2.2.69  |
| 0100 1011                 | GPS Assistance Data   | 3.2.2.70  |
| 0100 1100                 | Deciphering Keys  | 3.2.2.71  |
| 0100 1101                 | Return Error Request  | 3.2.2.72  |
| 0100 1110                 | Return Error Cause  | 3.2.2.73  |
| 0100 1111                 | Segmentation  | 3.2.2.74  |
| 0101 0000                 | Service Handover  | 3.2.2.75  |
| 0101 0001 (NOTE)          | Source RNC to target RNC transparent information (UMTS)     | 3.2.2.76  |
| 0101 0010 (NOTE)          | Source RNC to target RNC transparent information (cdma2000) | 3.2.2.77  |
| 0100 0001                 | Reserved  | #         |
| 0100 0010                 | Reserved  | #         |

NOTE. This encoding aligns with the RANAP specified tagging. The coding is defined in relevant RANAP specification 3GPP TS 25.413 [31].

\* Information Element codes marked as "reserved" are reserved for use by previous versions of this interface specification

# Information Element codes marked as "reserved" are reserved for use by ANSI version of this interface specification

### 3.2.2.1 Message Type

Message Type uniquely identifies the message being sent. It is a single octet element, mandatory in all messages.

Bit 8 is reserved for future extension of the code set. All unassigned codes are spare.

|                                   | <b>8 7 6 5 4 3 2 1</b>   |  |
|-----------------------------------|--|--|
|                                   | 0 0 0 0 0 0 0 0  | Reserved.  |
| ASSIGNMENT MESSAGES               | 0 0 0 0 0 0 0 1<br>0 0 0 0 0 0 1 0<br>0 0 0 0 0 0 1 1  | ASSIGNMENT REQUEST<br>ASSIGNMENT COMPLETE<br>ASSIGNMENT FAILURE  |
| HANDOVER MESSAGES                 | 0 0 0 1 0 0 0 0<br>0 0 0 1 0 0 0 1<br>0 0 0 1 0 0 1 0<br>0 0 0 1 0 0 1 1<br>0 0 0 1 0 1 0 0<br>0 0 0 1 0 1 0 1<br>0 0 0 1 0 1 1 0<br>0 0 0 1 0 1 1 1<br>0 0 0 1 1 0 0 0<br>0 0 0 1 1 0 0 1<br>0 0 0 1 1 0 1 0<br>0 0 0 1 1 0 1 1 | HANDOVER REQUEST<br>HANDOVER REQUIRED<br>HANDOVER REQUEST ACKNOWLEDGE<br>HANDOVER COMMAND<br>HANDOVER COMPLETE<br>HANDOVER SUCCEEDED<br>HANDOVER FAILURE<br>HANDOVER PERFORMED<br>HANDOVER CANDIDATE ENQUIRE<br>HANDOVER CANDIDATE RESPONSE<br>HANDOVER REQUIRED REJECT<br>HANDOVER DETECT |
| RELEASE MESSAGES                  | 0 0 1 0 0 0 0 0<br>0 0 1 0 0 0 0 1<br>0 0 1 0 0 0 1 0<br>0 0 1 0 0 0 1 1<br>0 0 1 0 0 1 0 0<br>0 0 1 0 0 1 0 1<br>0 0 1 0 0 1 0 1<br>0 0 1 0 0 1 1 0   | CLEAR COMMAND<br>CLEAR COMPLETE<br>CLEAR REQUEST<br>RESERVED<br>RESERVED<br>SAPI "N" REJECT<br>CONFUSION   |
| OTHER CONNECTION RELATED MESSAGES | 0 0 1 0 1 0 0 0<br>0 0 1 0 1 0 0 1<br>0 0 1 0 1 0 1 0<br>0 0 1 0 1 0 1 1<br>0 0 1 0 1 1 0 0<br>0 0 1 0 1 1 0 1<br>0 0 1 0 1 1 1 0<br>0 0 1 0 1 1 1 1   | SUSPEND<br>RESUME<br>Reserved (See NOTE)<br>PERFORM LOCATION REQUEST<br>LSA INFORMATION<br>PERFORM LOCATION RESPONSE<br>PERFORM LOCATION ABORT<br>COMMON ID  |
| GENERAL MESSAGES                  | 0 0 1 1 0 0 0 0<br>0 0 1 1 0 0 0 1<br>0 0 1 1 0 0 1 0<br>0 0 1 1 0 0 1 1<br>0 0 1 1 0 1 0 0<br>0 0 1 1 0 1 0 1<br>0 0 1 1 0 1 1 0<br>0 0 1 1 0 1 1 1<br>0 0 1 1 1 0 1 0  | RESET<br>RESET ACKNOWLEDGE<br>OVERLOAD<br>RESERVED<br>RESET CIRCUIT<br>RESET CIRCUIT ACKNOWLEDGE<br>MSC INVOKE TRACE<br>BSS INVOKE TRACE<br>CONNECTIONLESS INFORMATION   |
| TERRESTRIAL RESOURCE MESSAGES     | 0 1 0 0 0 0 0 0<br>0 1 0 0 0 0 0 1<br>0 1 0 0 0 0 1 0<br>0 1 0 0 0 0 1 1<br>0 1 0 0 0 1 0 0<br>0 1 0 0 0 1 0 1<br>0 1 0 0 0 1 1 0<br>0 1 0 0 0 1 1 1<br><br>0 1 0 0 1 0 0 0<br>0 1 0 0 1 1 1 0<br>0 1 0 0 1 1 1 1                | BLOCK<br>BLOCKING ACKNOWLEDGE<br>UNBLOCK<br>UNBLOCKING ACKNOWLEDGE<br>CIRCUIT GROUP BLOCK<br>CIRCUIT GROUP BLOCKING ACKNOWLEDGE<br>CIRCUIT GROUP UNBLOCK<br>CIRCUIT GROUP UNBLOCKING<br>ACKNOWLEDGE<br>UNEQUIPPED CIRCUIT<br>CHANGE CIRCUIT<br>CHANGE CIRCUIT ACKNOWLEDGE                  |



|                         | 8 7 6 5 4 3 2 1 |                              |
|-------------------------|-----------------|------------------------------|
| RADIO RESOURCE MESSAGES | 0 1 0 1 0 0 0 0 | RESOURCE REQUEST             |
|                         | 0 1 0 1 0 0 0 1 | RESOURCE INDICATION          |
|                         | 0 1 0 1 0 0 1 0 | PAGING                       |
|                         | 0 1 0 1 0 0 1 1 | CIPHER MODE COMMAND          |
|                         | 0 1 0 1 0 1 0 0 | CLASSMARK UPDATE             |
|                         | 0 1 0 1 0 1 0 1 | CIPHER MODE COMPLETE         |
|                         | 0 1 0 1 0 1 1 0 | QUEUING INDICATION           |
|                         | 0 1 0 1 0 1 1 1 | COMPLETE LAYER 3 INFORMATION |
|                         | 0 1 0 1 1 0 0 0 | CLASSMARK REQUEST            |
|                         | 0 1 0 1 1 0 0 1 | CIPHER MODE REJECT           |
|                         | 0 1 0 1 1 0 1 0 | LOAD INDICATION              |
| VGCS/VBS                | 0 0 0 0 0 1 0 0 | VGCS/VBS SETUP               |
|                         | 0 0 0 0 0 1 0 1 | VGCS/VBS SETUP ACK           |
|                         | 0 0 0 0 0 1 1 0 | VGCS/VBS SETUP REFUSE        |
|                         | 0 0 0 0 0 1 1 1 | VGCS/VBS ASSIGNMENT REQUEST  |
|                         | 0 0 0 1 1 1 0 0 | VGCS/VBS ASSIGNMENT RESULT   |
|                         | 0 0 0 1 1 1 0 1 | VGCS/VBS ASSIGNMENT FAILURE  |
|                         | 0 0 0 1 1 1 1 0 | VGCS/VBS QUEUING INDICATION  |
|                         | 0 0 0 1 1 1 1 1 | UPLINK REQUEST               |
|                         | 0 0 1 0 0 1 1 1 | UPLINK REQUEST ACKNOWLEDGE   |
|                         | 0 1 0 0 1 0 0 1 | UPLINK REQUEST CONFIRMATION  |
|                         | 0 1 0 0 1 0 1 0 | UPLINK RELEASE INDICATION    |
|                         | 0 1 0 0 1 0 1 1 | UPLINK REJECT COMMAND        |
|                         | 0 1 0 0 1 1 0 0 | UPLINK RELEASE COMMAND       |
|                         | 0 1 0 0 1 1 0 1 | UPLINK SEIZED COMMAND        |

NOTE: This value was allocated in an earlier phase of the protocol and shall not be used in the future.

### 3.2.2.2 Circuit Identity Code

This element defines the terrestrial channel over which the call will pass.

If a 2048 kbits/s digital path is used then the circuit identification code contains in the five least significant bits a binary representation of the actual number of the timeslot which is assigned to the circuit. The remaining bits in the CIC are used where necessary to identify one among several systems interconnecting an originating and destination point.

The element is 2 octets in length:

| 8                  | 7 | 6 | 5 | 4 | 3 | 2 | 1 |         |
|--------------------|---|---|---|---|---|---|---|---------|
| Element identifier |   |   |   |   |   |   |   | octet 1 |
| a                  | b | c | d | e | f | g | h | octet 2 |
| i                  | j | k | X | X | X | X | X | octet 3 |

a-k defines the PCM multiplex in use.

XXXXX define the actual timeslot in use.

The circuit identity code defines the PCM multiplex and timeslot in use at the MSC. In cases where remultiplexing takes place between the MSC and BSS a translation may be necessary at the BSS.

If a 1544 kbit/s digital path is used, then the format of the circuit identity code (CIC) shall be as shown below:

The element is 2 octets in length:

| 8                            | 7 | 6 | 5 | 4 | 3 | 2 | 1 |         |
|------------------------------|---|---|---|---|---|---|---|---------|
| Element identifie            |   |   |   |   |   |   |   | octet 1 |
| CIC (least significant bits) |   |   |   |   |   |   |   | octet 2 |
| CIC (most significant bits)  |   |   |   |   |   |   |   | octet 3 |

### 3.2.2.3 Connection Release Requested

The element has a fixed length of one octet

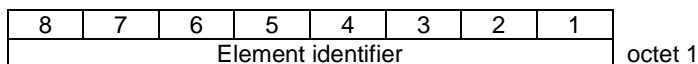

### 3.2.2.4 Resource Available

This element gives the number of full and half rate channels available on any given cell at the time of construction of the message.

It defines these parameters in terms of the number of channels available in five interference bands, the boundaries of these bands being set by O and M as follows:

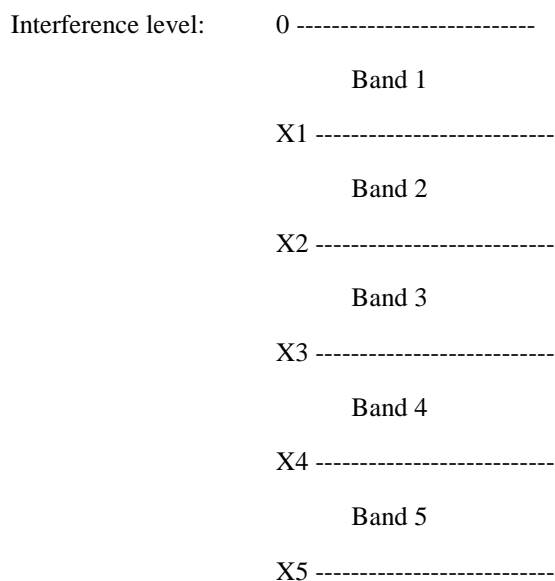

The element is coded as follows:

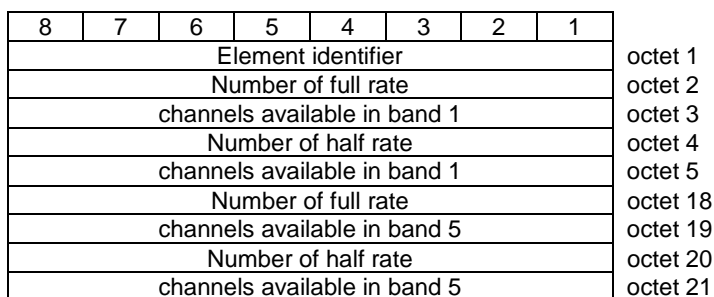

Octets (2,3,4,5,) are then repeated for each of the other interference bands giving a total message length of 21 octets.

Octets 2 and 3 give a 16 bit binary representation of the number of full rate channels available for service but not currently assigned.

Octets 4 and 5 give a 16 bit binary representation of the number of half rate channels available for service but not currently assigned. This will include half rate channels already counted in octets 2 and 3, if these correspond to full rate channels that can be used as half rate channels.

(e.g. If there is a spare half rate channel and a spare full rate channel that can be used as two half rate channels, then the full rate count will be 1 and the half rate count will be 3).

Octets 3 and 5 are the least significant octets, and bit 1 is the least significant bit.

### 3.2.2.5 Cause

The cause element is used to indicate the reason for a particular event to have occurred and is coded as shown below.

The cause value is a single octet element if the extension bit (bit 8) is set to 0. If it is set to 1 then the cause value is a 2 octet field. If the value of the first octet of the cause field is 1XXX 0000 then the second octet is reserved for national applications (XXX will still indicate the class).

|                    |             |   |   |   |   |   |   |           |
|--------------------|-------------|---|---|---|---|---|---|-----------|
| 8                  | 7           | 6 | 5 | 4 | 3 | 2 | 1 |           |
| Element identifier |             |   |   |   |   |   |   | octet 1   |
| Length             |             |   |   |   |   |   |   | octet 2   |
| 0/1 ext            | Cause Value |   |   |   |   |   |   | octet 3   |
|                    |             |   |   |   |   |   |   | (octet 4) |

The length indicator is a binary representation of the length of the following element.

Cause Value:

|              |   |
|--------------|---|
| Class (000): | Normal event                                |
| Class (001): | Normal event                                |
| Class (010): | Resource unavailable                        |
| Class (011): | Service or option not available             |
| Class (100): | Service or option not implemented           |
| Class (101): | invalid message (eg parameter out of range) |
| Class (110): | protocol error                              |
| Class (111): | interworking                                |

In the following table, "reserved for international use" means that this codepoint should not be used until a meaning has been assigned to it following the process of international standardisation. "Reserved for national use" indicates codepoints that may be used by operators without the need for international standardization.

| Cause value |   |    |       |   |   |   | Cause Number |   |
|-------------|---|----|-------|---|---|---|--------------|---|
| Class       |   |    | Value |   |   |   |              |   |
| 7           | 6 | 5  | 4     | 3 | 2 | 1 |              |   |
| 0           | 0 | 0  | 0     | 0 | 0 | 0 |              | Radio interface message failure                   |
| 0           | 0 | 0  | 0     | 0 | 0 | 1 |              | Radio interface failure                           |
| 0           | 0 | 0  | 0     | 0 | 1 | 0 |              | Uplink quality                                    |
| 0           | 0 | 0  | 0     | 0 | 1 | 1 |              | Uplink strength                                   |
| 0           | 0 | 0  | 0     | 1 | 0 | 0 |              | Downlink quality                                  |
| 0           | 0 | 0  | 0     | 1 | 0 | 1 |              | Downlink strength                                 |
| 0           | 0 | 0  | 0     | 1 | 1 | 0 |              | Distance  |
| 0           | 0 | 0  | 0     | 1 | 1 | 1 |              | O and M intervention                              |
| 0           | 0 | 0  | 1     | 0 | 0 | 0 |              | Response to MSC invocation                        |
| 0           | 0 | 0  | 1     | 0 | 0 | 1 |              | Call control                                      |
| 0           | 0 | 0  | 1     | 0 | 1 | 0 |              | Radio interface failure, reversion to old channel |
| 0           | 0 | 0  | 1     | 0 | 1 | 1 |              | Handover successful                               |
| 0           | 0 | 0  | 1     | 1 | 0 | 0 |              | Better Cell                                       |
| 0           | 0 | 0  | 1     | 1 | 0 | 1 |              | Directed Retry                                    |
| 0           | 0 | 0  | 1     | 1 | 1 | 0 |              | Joined group call channel                         |
| 0           | 0 | 0  | 1     | 1 | 1 | 1 |              | Traffic   |
| 0           | 0 | 1  | 0     | 0 | 0 | 0 |              | }   |
|             |   | to |       |   |   |   |              | } Reserved for international use                  |
| 0           | 0 | 1  | 0     | 1 | 1 | 1 |              | }   |
| 0           | 0 | 1  | 1     | 0 | 0 | 0 |              | }   |
|             |   | to |       |   |   |   |              | } Reserved for national use                       |
| 0           | 0 | 1  | 1     | 1 | 1 | 1 |              | }   |
| 0           | 1 | 0  | 0     | 0 | 0 | 0 |              | Equipment failure                                 |
| 0           | 1 | 0  | 0     | 0 | 0 | 1 |              | No radio resource available                       |
| 0           | 1 | 0  | 0     | 0 | 1 | 0 |              | Requested terrestrial resource unavailable        |
| 0           | 1 | 0  | 0     | 0 | 1 | 1 |              | CCCH overload                                     |
| 0           | 1 | 0  | 0     | 1 | 0 | 0 |              | Processor overload                                |
| 0           | 1 | 0  | 0     | 1 | 0 | 1 |              | BSS not equipped                                  |
| 0           | 1 | 0  | 0     | 1 | 1 | 0 |              | MS not equipped                                   |
| 0           | 1 | 0  | 0     | 1 | 1 | 1 |              | Invalid cell                                      |
| 0           | 1 | 0  | 1     | 0 | 0 | 0 |              | Traffic Load                                      |
| 0           | 1 | 0  | 1     | 0 | 0 | 1 |              | Preemption  |
| 0           | 1 | 0  | 1     | 0 | 1 | 0 |              | }   |
|             |   | to |       |   |   |   |              | } Reserved for national use                       |
| 0           | 1 | 0  | 1     | 1 | 1 | 1 |              | }   |
| 0           | 1 | 1  | 0     | 0 | 0 | 0 |              | Requested transcoding/rate adaption unavailable   |
| 0           | 1 | 1  | 0     | 0 | 0 | 1 |              | Circuit pool mismatch                             |
| 0           | 1 | 1  | 0     | 0 | 1 | 0 |              | Switch circuit pool                               |
| 0           | 1 | 1  | 0     | 0 | 1 | 1 |              | Requested speech version unavailable              |
| 0           | 1 | 1  | 0     | 1 | 0 | 0 |              | LSA not allowed                                   |
| 0           | 1 | 1  | 0     | 1 | 0 | 1 |              | }   |
|             |   | to |       |   |   |   |              | } Reserved for international use                  |
| 0           | 1 | 1  | 1     | 1 | 1 | 1 |              | }   |
| 1           | 0 | 0  | 0     | 0 | 0 | 0 |              | Ciphering algorithm not supported                 |
| 1           | 0 | 0  | 0     | 0 | 0 | 1 |              | }   |
|             |   | to |       |   |   |   |              | } Reserved for international use                  |
| 1           | 0 | 0  | 0     | 1 | 1 | 1 |              | }   |
| 1           | 0 | 0  | 0     | 1 | 1 | 1 |              | }   |
|             |   | to |       |   |   |   |              | } Reserved for national use                       |
| 1           | 0 | 0  | 1     | 1 | 1 | 1 |              | }   |
| 1           | 0 | 1  | 0     | 0 | 0 | 0 |              | Terrestrial circuit already allocated             |
| 1           | 0 | 1  | 0     | 0 | 0 | 1 |              | Invalid message contents                          |
| 1           | 0 | 1  | 0     | 0 | 1 | 0 |              | Information element or field missing              |
| 1           | 0 | 1  | 0     | 0 | 1 | 1 |              | Incorrect value                                   |
| 1           | 0 | 1  | 0     | 1 | 0 | 0 |              | Unknown Message type                              |
| 1           | 0 | 1  | 0     | 1 | 0 | 1 |              | Unknown Information Element                       |

| Cause value |   |   |       |   |   |   | Cause                              |
|-------------|---|---|-------|---|---|---|------------------------------------|
| Class       |   |   | Value |   |   |   | Number                             |
| 1           | 0 | 1 | 0     | 1 | 1 | 0 | } Reserved for international use   |
| 1           | 0 | 1 | 0     | 1 | 1 | 1 |                                    |
| 1           | 0 | 1 | 1     | 0 | 0 | 0 | } Reserved for national use        |
| 1           | 0 | 1 | 1     | 1 | 1 | 1 |                                    |
| 1           | 1 | 0 | 0     | 0 | 0 | 0 | Protocol Error between BSS and MSC |
| 1           | 1 | 0 | 0     | 0 | 0 | 1 | VGCS/VBS call non existent         |
| 1           | 1 | 0 | 0     | 0 | 1 | 0 | } Reserved for international use   |
| 1           | 1 | 0 | 0     | 1 | 1 | 1 |                                    |
| 1           | 1 | 0 | 1     | 0 | 0 | 0 | } Reserved for national use        |
| 1           | 1 | 0 | 1     | 1 | 1 | 1 |                                    |
| 1           | 1 | 1 | 0     | 0 | 0 | 0 | } Reserved for international use   |
| 1           | 1 | 1 | 0     | 1 | 1 | 1 |                                    |
| 1           | 1 | 1 | 1     | 0 | 0 | 0 | } Reserved for national use        |
| 1           | 1 | 1 | 1     | 1 | 1 | 1 |                                    |

### 3.2.2.6 IMSI

The IMSI is coded as a sequence of BCD digits, compressed two into each octet. This is a variable length element, and includes a length indicator. The remainder of this element is coded as defined in 3GPP TS 24.008 [6].

The element coding is:

|  |   |   |   |   |   |   |   |                    |         |
|--|---|---|---|---|---|---|---|--------------------|---------|
| 8  | 7 | 6 | 5 | 4 | 3 | 2 | 1 | Element identifier | octet 1 |
| Length   |   |   |   |   |   |   |   |                    | octet 2 |
| Rest of element coded as in 3GPP TS 24.008 [6], not including 3GPP TS 24.008 [6] element identifier or 3GPP TS 24.008 [6] octet length value |   |   |   |   |   |   |   | octet 3 - n        |         |

### 3.2.2.7 TMSI

The TMSI is a fixed length element. The TMSI is an unstructured number of 4 octets in length.

The coding is:

|        |   |   |   |   |   |   |   |                    |         |
|--------|---|---|---|---|---|---|---|--------------------|---------|
| 8      | 7 | 6 | 5 | 4 | 3 | 2 | 1 | Element identifier | octet 1 |
| Length |   |   |   |   |   |   |   |                    | octet 2 |
| TMSI   |   |   |   |   |   |   |   | octet 3 - 6        |         |

The TMSI field is unstructured.

### 3.2.2.8 Number Of MSs

This is a fixed length element which indicates the number of handover candidates that have been sent to the MSC.

The coding is:

|                               |   |   |   |   |   |   |   |                    |         |
|-------------------------------|---|---|---|---|---|---|---|--------------------|---------|
| 8                             | 7 | 6 | 5 | 4 | 3 | 2 | 1 | Element identifier | octet 1 |
| Number of handover candidates |   |   |   |   |   |   |   |                    | octet 2 |

Octet 2 is a binary indication of the number of handover candidates. Bit 1 is the least significant bit.

### 3.2.2.9 Layer 3 Header Information

This element is used to supply the BSS with information that needs to be included in the header of layer 3 messages over the radio interface.

|                        |   |   |   |   |   |   |   |         |
|------------------------|---|---|---|---|---|---|---|---------|
| 8                      | 7 | 6 | 5 | 4 | 3 | 2 | 1 |         |
| Element identifier     |   |   |   |   |   |   |   | octet 1 |
| Length                 |   |   |   |   |   |   |   | octet 2 |
| Protocol discriminator |   |   |   |   |   |   |   | octet 3 |
| Transaction identifier |   |   |   |   |   |   |   | octet 4 |

The length indicator is a binary indication of the number of octets following in the element.

The transaction identifier and protocol discriminator fields are coded as defined in 3GPP TS 24.008 [6]. The protocol discriminator occupies bit 1 to 4 in octet 3 of Layer 3 header information, the Transaction identifier occupies bit 1 to 4 in octet 4 of the Layer 3 header information.

### 3.2.2.10 Encryption Information

This element contains the user data encryption information used to control any encryption equipment at the BSS.

It is a variable length element.

It is coded as follows:

|                      |   |   |   |   |   |   |   |             |
|----------------------|---|---|---|---|---|---|---|-------------|
| 8                    | 7 | 6 | 5 | 4 | 3 | 2 | 1 |             |
| Element identifier   |   |   |   |   |   |   |   | octet 1     |
| Length               |   |   |   |   |   |   |   | octet 2     |
| Permitted algorithms |   |   |   |   |   |   |   | octet 3     |
| Key                  |   |   |   |   |   |   |   | octet 4 - n |

The length indicator (octet 2) is a binary number indicating the absolute length of the contents after the length indicator octet.

The permitted algorithms octet is a bit map indicating the A5 encryption algorithms and no encryption. From this bit map the BSS may select an A5 algorithm or no encryption to be used.

| <u>Bit No</u> | <u>meaning</u> |
|---------------|----------------|
| 1             | No encryption  |
| 2             | GSM A5/1       |
| 3             | GSM A5/2       |
| 4             | GSM A5/3       |
| 5             | GSM A5/4       |
| 6             | GSM A5/5       |
| 7             | GSM A5/6       |
| 8             | GSM A5/7       |

A bit position encoded as 1 indicates that the BSS may use the option represented by that bit position. A bit position encoded as 0 indicates that the BSS shall not use the option represented by that bit position. A permitted algorithms octet containing all bits encoded as 0 shall not be used.

The key shall be present if at least one of the A5 encryption algorithms is permitted. Over MAP/E interface to 3G\_MSC-B the key shall be present if available. When present, the key shall be 8 octets long.

### 3.2.2.11 Channel Type

This element contains all of the information that the BSS requires to determine the required radio resource(s).

The channel type information element has a minimum length of 5 octets and a maximum length of 10 octets. It is coded as follows:

|  |   |   |   |                         |   |   |   |   |
|--|---|---|---|-------------------------|---|---|---|---|
| 8  | 7 | 6 | 5 | 4                       | 3 | 2 | 1 |   |
| Element identifier   |   |   |   |                         |   |   |   | octet 1                                   |
| Length   |   |   |   |                         |   |   |   | octet 2                                   |
| Spare  |   |   |   | Speech / data indicator |   |   |   | octet 3                                   |
| Channel rate and type  |   |   |   |                         |   |   |   | octet 4                                   |
| Permitted speech version indication / data rate + transparency indicator |   |   |   |                         |   |   |   | octet 5<br>or<br>octet 5 with extension * |

\* If the speech / data indicator (octet 3) indicates "speech" or "data", octet 5 may optionally be extended. Otherwise octet 5 shall not be extended.

The "speech / data indicator" field is coded as follows:

| code                           | meaning    |
|--------------------------------|------------|
| 0001                           | Speech     |
| 0010                           | Data       |
| 0011                           | Signalling |
| All other values are reserved. |            |

For values 0001 and 0010 a dedicated terrestrial resource is also required.

The "channel rate and type" is coded as follows:

If octet 3 indicates data then octet 4 shall be coded as:

| code      | meaning  |
|-----------|--|
| 0000 1000 | Full rate TCH channel Bm   |
| 0000 1001 | Half rate TCH channel Lm   |
| 0000 1010 | Full or Half rate TCH channel, Full rate preferred, changes allowed also after first channel allocation as a result of the request.  |
| 0000 1011 | Full or Half rate TCH channel, Half rate preferred, changes allowed also after first channel allocation as a result of the request.  |
| 0001 1010 | Full or Half rate TCH channel, Full rate preferred, changes not allowed after first channel allocation as a result of the request.   |
| 0001 1011 | Full or Half rate TCH channel. Half rate preferred, changes not allowed after first channel allocation as a result of the request.   |
| 0010 0xxx | Full rate TCH channels in a multislot configuration, changes by the BSS of the the number of TCHs and if applicable the used radio interface rate per channel allowed after first channel allocation as a result of the request. |
| 0011 0xxx | Full rate TCH channels in a multislot configuration, changes by the BSS of the number of TCHs or the used radio interface rate per channel not allowed after first channel allocation as a result of the request.                |

xxx (bits 3-1) indicates maximum number of traffic channels;

| bits | meaning |
|------|---------|
| 321  |         |
| 000  | 1 TCHs  |
| 001  | 2 TCHs  |
| 010  | 3 TCHs  |
| 011  | 4 TCHs  |
| 100  | 5 TCHs  |
| 101  | 6 TCHs  |
| 110  | 7 TCHs  |
| 111  | 8 TCHs  |

All other values are reserved.

If octet 3 indicates speech then octet 4 shall be coded as:

| code      | meaning  |
|-----------|--|
| 0000 1000 | Full rate TCH channel Bm. Preference between the permitted speech versions for full rate TCH as indicated in octet 5, 5a etc..   |
| 0000 1001 | Half rate TCH channel Lm. Preference between the permitted speech versions for half rate TCH as indicated in octet 5, 5a etc..   |
| 0000 1010 | Full or Half rate TCH channel, Full rate preferred, changes between full rate and half rate allowed also after first channel allocation as a result of the request. Preference between the permitted speech versions for the respective channel rates as indicated in octet 5, 5a etc. |
| 0000 1011 | Full or Half rate TCH channel, Half rate preferred, changes between full rate and half rate allowed also after first channel allocation as a result of the request. Preference between the permitted speech versions for the respective channel rates as indicated in octet 5, 5a etc. |
| 0001 1010 | Full or Half rate TCH channel, Full rate preferred, changes between full rate and half rate not allowed after first channel allocation as a result of the request. Preference between the permitted speech versions for the respective channel rates as indicated in octet 5, 5a etc.  |
| 0001 1011 | Full or Half rate TCH channel. Half rate preferred, changes between full rate and half rate not allowed after first channel allocation as a result of the request. Preference between the permitted speech versions for the respective channel rates as indicated in octet 5, 5a etc.  |
| 0000 1111 | Full or Half rate TCH channel. Preference between the permitted speech versions as indicated in octet 5, 5a etc., changes between full and half rate allowed also after first channel allocation as a result of the request  |
| 0001 1111 | Full or Half rate TCH channel. Preference between the permitted speech versions as indicated in octet 5, 5a etc., changes between full and half rate not allowed after first channel allocation as a result of the request   |

All other values are reserved.

If octet 3 indicates signalling then octet 4 shall be coded as:

| code      | meaning   |
|-----------|---|
| 0000 0000 | SDCCH or Full rate TCH channel Bm or Half rate TCH channel Lm<br>0000 0001SDCCH   |
| 0000 0010 | SDCCH or Full rate TCH channel Bm   |
| 0000 0011 | SDCCH or Half rate TCH channel Lm   |
| 0000 1000 | Full rate TCH channel Bm  |
| 0000 1001 | Half rate TCH channel Lm  |
| 0000 1010 | Full or Half rate TCH channel, Full rate preferred, changes allowed also after first channel allocation as a result of the request. |
| 0000 1011 | Full or Half rate TCH channel, Half rate preferred, changes allowed also after first channel allocation as a result of the request. |
| 0001 1010 | Full or Half rate TCH channel, Full rate preferred, changes not allowed after first channel allocation as a result of the request.  |
| 0001 1011 | Full or Half rate TCH channel. Half rate preferred, changes not allowed after first channel allocation as a result of the request.  |

All other values are reserved.

The " permitted speech version indication / data rate + transparency indicator" octet is coded as follows:

- If octet 3 indicates speech then octet 5 shall be coded as follows:



| 8   | 7                                   | 6 | 5 | 4 | 3 | 2 | 1 |          |
|-----|-------------------------------------|---|---|---|---|---|---|----------|
| ext | permitted speech version identifier |   |   |   |   |   |   | octet 5  |
| ext | permitted speech version identifier |   |   |   |   |   |   | octet 5a |
| ext | permitted speech version identifier |   |   |   |   |   |   | octet 5b |
| ext | permitted speech version identifier |   |   |   |   |   |   | octet 5c |
| ext | permitted speech version identifier |   |   |   |   |   |   | octet 5d |
| 0   | permitted speech version identifier |   |   |   |   |   |   | octet 5e |

Bit 8 indicates extension of octet 5.

- 0 no extension, i.e. value "0" indicates that this octet is the last octet.
- 1 extension, i.e. value "1" indicates that at least one additional octet is included.

- If more than one permitted speech version is indicated by octet 5 (with extension), then the speech version choice is left to the BSS.

Bits 7-1 indicate the permitted speech version identifier;

bits

| <u>765 4321</u> | <u>meaning</u>                 |
|-----------------|--------------------------------|
| 000 0001        | GSM speech full rate version 1 |
| 001 0001        | GSM speech full rate version 2 |
| 010 0001        | GSM speech full rate version 3 |
| 000 0101        | GSM speech half rate version 1 |
| 001 0101        | GSM speech half rate version 2 |
| 010 0101        | GSM speech half rate version 3 |

NOTE: Bits 7 - 1 indicate six speech versions.

The GSM speech versions are also referred as follows (see 3GPP TS 26.103 [44]):

- GSM speech full rate version 1: GSM FR
- GSM speech full rate version 2: GSM EFR
- GSM speech full rate version 3: FR AMR
- GSM speech half rate version 1: GSM HR
- GSM speech half rate version 2: not defined in this version of the protocol
- GSM speech half rate version 3: HR AMR

All other values of permitted speech version identifiers are for future use. If an unknown value is received and more than one octet 5 is received the sender expects the receiver to behave as if it has made a choice of speech version.

The rules for coding preferences in octet 5, 5a - 5e are the following:

- In those cases when one specific channel rate is indicated in octet 4, the non-empty set of permitted speech versions is included. Within this set the permitted speech versions are included in order of speech version preferences.
- In those cases when a preference for a channel rate is indicated in octet 4, the non-empty sets of permitted speech versions for the respective channel rate are included in order of the channel rate preferences indicated in octet 4. Within a set of permitted speech versions for a channel rate, the permitted speech versions are included in order of speech version preferences.
- In those cases when no preference or specific channel rate is indicated in octet 4, the permitted speech versions are included in order of speech version preferences.

Always octet 5 has the highest preference followed by octet 5a and so on. For each channel rate allowed by octet 4 at least one speech version shall be present.

If octet 5 indicates no extension and bits 7-1 is coded "000 0001", then the preference is interpreted based upon the octet 4 value as follows:

- in those cases when octet 4 indicates one specific channel rate, then "speech version 1" for the indicated channel rate is permitted.

- in those cases when octet 4 indicates a preference for a channel rate, then "speech version 1" for any of the allowed channel rates is permitted.
- in those cases when octet 4 does neither indicate a preference for a channel rate nor a specific channel rate, then "speech version 1" for any of the allowed channel rates is permitted and speech full rate version 1 is preferred.

If octet 3 indicates data, and octet 4 does not indicate multislot configuration, then octet 5 shall be coded as follows:

|     |                      |      |       |   |   |   |          |         |
|-----|----------------------|------|-------|---|---|---|----------|---------|
| 8   | 7                    | 6    | 5     | 4 | 3 | 2 | 1        |         |
| ext | T/NT                 | Rate |       |   |   |   |          | octet 5 |
| ext | allowed r i/f rates  |      |       |   |   |   | octet 5a |         |
| ext | asymmetry indication |      | spare |   |   |   | octet 5b |         |

Bit 8 indicates extension of octet 5.

- 0 no extension, i.e. value "0" indicates that this octet is the last octet.
- 1 extension, i.e. value "1" indicates that at least one additional octet is included.

Bit 7 :

- 0 Transparent service
- 1 Non-transparent service.

For non-transparent service bits 6-1 indicate the radio interface data rate;

| <u>65 4321</u> | <u>meaning</u>  |
|----------------|---|
| 00 0000        | 12 kbit/s if the channel is a full rate TCH, or<br>6 kbit/s if the channel is a half rate TCH |
| 11 0100        | 43.5 kbit/s   |
| 11 0001        | 29 kbit/s   |
| 01 1000        | 14.5 kbit/s   |
| 01 0000        | 12 kbits/s  |
| 01 0001        | 6 kbits/s   |

If bit 7 in octet 5 indicates non-transparent service and octet 5a is included the 'rate' in octet 5 indicates the wanted air interface data rate and the 'allowed r i/f rates' indicates the other possible data rates allowed.

All other values are reserved.

For transparent service bits 6-1 indicate the data rate;

| <u>65 4321</u> | <u>meaning</u>  |
|----------------|---|
| 11 1010        | 32.0 kbit/s   |
| 11 1001        | 28.8 kbit/s   |
| 01 1000        | 14.4 kbit/s   |
| 01 0000        | 9.6kbit/s   |
| 01 0001        | 4.8kbit/s   |
| 01 0010        | 2.4kbit/s   |
| 01 0011        | 1.2Kbit/s   |
| 01 0100        | 600 bit/s   |
| 01 0101        | 1200/75 bit/s (1200 network-to-MS / 75 MS-to-network) |

If bit 7 in octet 5 indicates transparent service octet 5 shall not be extended.

All other values are reserved.

Octet 5a shall be coded as follows;

- Bit 8 reserved for extension.  
A coding of 0 indicates no extension

Bits 7 to 1 indicate allowed radio interface data rate, per channel;

- Bit 7: 0 43.5 kbit/s (TCH/F43.2) not allowed

- 1 43.5 kbit/s (TCH/F43.2) allowed
- Bit 6: 0 32.0 kbit/s (TCH/F32.0) not allowed  
1 32.0 kbit/s (TCH/F32.0) allowed
- Bit 5: 0 29.0 kbit/s (TCH/F28.8) not allowed  
1 29.0 kbit/s (TCH/F28.8) allowed
- Bit 4: 0 14.5 kbit/s (TCH/F14.4) not allowed  
1 14.5 kbit/s (TCH/F14.4) allowed
- Bit 3: Spare
- Bit 2: 0 12.0 kbit/s (TCH/F9.6) not allowed  
1 12.0 kbit/s (TCH/F9.6) allowed
- Bit 1: 0 6.0 kbit/s (TCH/F4.8) not allowed  
1 6.0 kbit/s (TCH/F4.8) allowed

Octet 5b shall be coded as follows:

- Bit 8 reserved for extension.  
A coding of 0 indicates no extension

Bits 7 and 6 indicate the asymmetry preference:

- Bit 76
- 00 Not applicable
- 10 Downlink biased asymmetry is preferred
- 01 Uplink biased asymmetry is preferred
- 11 Spare

Bits 5 to 1 are spare

NOTE: "Not applicable" means that a symmetric service is preferred

If octet 5b is not included, symmetry shall be presumed.

If octet 3 indicates data and octet 4 indicates Full rate TCH channels in a multislot configuration, octet 5 and 5a shall be coded as follows;

|     |                      |      |       |   |   |   |   |          |
|-----|----------------------|------|-------|---|---|---|---|----------|
| 8   | 7                    | 6    | 5     | 4 | 3 | 2 | 1 |          |
| ext | T/NT                 | Rate |       |   |   |   |   | octet 5  |
| ext | allowed r i/f rates  |      |       |   |   |   |   | octet 5a |
| ext | asymmetry indication |      | spare |   |   |   |   | octet 5b |

Octet 5 shall be coded as follows;

- Bit 8 : extension bit  
0 indicates no extension  
1 indicates that at least one additional octet is included
- Bit 7 : 0 Transparent service  
1 Non-transparent service.

For non-transparent service bits 6-1 indicates wanted total radio interface data rate;

| <b>65 4321</b> | <b>meaning</b>  |
|----------------|---|
| 01 0110        | 58 / 58 kbit/s (4x14.5 kbit/s or 2 x29.0 kbit/s)                            |
| 01 0100        | 48.0 / 43.5 / 43.5 kbit/s (4x12 kbit/s or 3x14.5 kbit/s or 1x43.5 kbit/s)   |
| 01 0011        | 36.0 / 29.0 / 29.0 kbit/s (3x12 kbit/s or 2x14.5 kbit/s or 1 x 29.0 kbit/s) |
| 01 0010        | 24.0 / 24.0 (4x6 kbit/s or 2x12 kbit/s)                                     |
| 01 0001        | 18.0 / 14.5 kbit/s (3x6 kbit/s or 1x14.5 kbit/s)                            |

01 0000          12.0 / 12.0 kbit/s (2x6 kbit/s or 1x12 kbit/s)

All other values are reserved.

For transparent service bits 6-1 indicates requested air interface user rate;

| <b>65 4321</b> | <b>meaning</b>             |
|----------------|----------------------------|
| 01 1111        | 64 kbit/s, bit transparent |
| 01 1110        | 56 kbit/s, bit transparent |
| 01 1101        | 56 kbit/s                  |
| 01 1100        | 48 kbit/s                  |
| 01 1011        | 38.4 kbit/s                |
| 01 0001        | 32 kbit/s                  |
| 01 1010        | 28.8 kbit/s                |
| 01 1001        | 19.2 kbit/s                |
| 01 1000        | 14.4 kbit/s                |
| 01 0000        | 9.6 kbit/s                 |

All other values are reserved.

Octet 5a shall be coded as follows;

|             |  |
|-------------|--|
| Bit 8       | reserved for extension.<br>A coding of 0 indicates no extension                      |
| Bits 7 to 1 | indicates allowed radio interface data rate, per channel;                            |
| Bit 7:      | 0 43.5 kbit/s (TCH/F43.2) not allowed<br>1 43.5 kbit/s (TCH/F43.2) allowed           |
| Bit 6:      | 0 32.0 kbit/s (TCH/F32.0) not allowed<br>1 32.0 kbit/s (TCH/F32.0) allowed           |
| Bit 5:      | 0 29.0 kbit/s (TCH/F28.8) not allowed<br>1 29.0 kbit/s (TCH/F28.8) allowed           |
| Bit 4:      | 0 14.5/14.4 kbit/s (TCH/F14.4) not allowed<br>1 14.5/14.4 kbit/s (TCH/F14.4) allowed |
| Bit 3:      | Spare  |
| Bit 2:      | 0 12.0/9.6 kbit/s (TCH F/9.6) not allowed<br>1 12.0/9.6 kbit/s (TCH F/9.6) allowed   |
| Bit 1:      | 0 6.0/4.8 kbit/s (TCH F/4.8) not allowed<br>1 6.0/4.8 kbit/s (TCH F/4.8) allowed     |

If octet 5a is not included, allowance of radio interface data rates of 12.0 and 6.0 shall be presumed.

NOTE: For data services, the information in the channel type Information Element is used to set the "E-bits" and map the "D-bits" (as described in 3GPP TS 44.002 and 3GPP TS 48.020 [18]) and to select the correct channel coding.

NOTE: 43.5 kbit/s is used only for nontransparent services.

Octet 5b is coded as follows:

|       |   |
|-------|---|
| Bit 8 | reserved for extension.<br>A coding of 0 indicates no extension |
|-------|---|

Bits 7 and 6 indicate the asymmetry preference:

Bit

|    |  |
|----|--|
| 76 | <u>meaning</u>                         |
| 00 | Not applicable                         |
| 10 | Downlink biased asymmetry is preferred |
| 01 | Uplink biased asymmetry is preferred   |
| 11 | Spare                                  |

Bits 5 to 1 are spare

NOTE: "Not applicable" means that a symmetric service is preferred

If octet 5b is not included, symmetry shall be presumed.

If octet 3 indicates signalling then octet 5 is spare.

### 3.2.2.12 Periodicity

This element defines the periodicity of a particular procedure. It is fixed length, 2 octets.

The coding is as follows:

|                    |   |   |   |   |   |   |   |         |
|--------------------|---|---|---|---|---|---|---|---------|
| 8                  | 7 | 6 | 5 | 4 | 3 | 2 | 1 |         |
| Element identifier |   |   |   |   |   |   |   | octet 1 |
| Periodicity        |   |   |   |   |   |   |   | octet 2 |

When the Resource Indication Method IE is set to either "method i) of subclause 3.1.3.1" or "method iii) of subclause 3.1.3.1" and the periodicity parameter is not 0000 0000 then the coding of the periodicity parameter is:

|           |        |
|-----------|--------|
| 0000 0001 | Period |
| 1111 1111 | -      |

where the period is the binary value of octet 2 \* 100 ms (ie 100 ms to 25,500 ms).

When the Resource Indication Method IE is set to "method i) of subclause 3.1.3.1" and the periodicity parameter is 0000 0000 then the BSS shall ignore this IE.

When the Resource Indication Method IE is set to "method iii) of subclause 3.1.3.1" and the periodicity parameter is 0000 0000 then the BSS shall treat the message according to subclause 3.1.19.4, case 2.

When the Resource Indication Method IE is set to either "method ii) of subclause 3.1.3.1" or "method iv) of subclause 3.1.3.1" then the Periodicity IE shall be ignored.

### 3.2.2.13 Extended Resource Indicator

This element defines which additional resource information related to a given cell the BSS shall transfer to the MSC. It may also indicate the subsequent reporting mode for that cell.

The coding is as follows:

|                    |   |   |   |   |   |    |      |         |
|--------------------|---|---|---|---|---|----|------|---------|
| 8                  | 7 | 6 | 5 | 4 | 3 | 2  | 1    |         |
| Element identifier |   |   |   |   |   |    |      | octet 1 |
| spare              |   |   |   |   |   | SM | TARR | octet 2 |

SM = Subsequent mode

TARR = Total Accessible Resource Requested

The coding of the Total Accessible Resource Requested field is as follows:

- 0 no extra Resource Information is requested
- 1 The total number of accessible channels is requested

If the Resource Indication Method is not set to "method ii of subclause 3.1.3.1" then the Subsequent Mode field is ignored.

If the Resource Indication Method is set to "method ii of subclause 3.1.3.1" then the Subsequent Mode field is decoded as follows:

- 0 method iv) of subclause 3.1.3.1.
- 1 if the reporting mode prior to receipt of this IE was i) or iii) of subclause 3.1.3.1 then the subsequent mode shall be respectively i) or iii); otherwise the subsequent mode shall be method iv) of subclause 3.1.3.1.

### 3.2.2.14 Total Resource Accessible

This element gives the total number of full and half rate channels accessible on any given cell at the time of construction of the message.

It defines these parameters in terms of the number of channels which are accessible or in use. No separation between the defined interference bands is made.

The element is coded as follows:

|   |   |   |   |   |   |   |   |                    |
|---|---|---|---|---|---|---|---|--------------------|
| 8   | 7 | 6 | 5 | 4 | 3 | 2 | 1 |                    |
| Element identifier                            |   |   |   |   |   |   |   | octet 1            |
| Total number of accessible full rate channels |   |   |   |   |   |   |   | octet 2<br>octet 3 |
| Total number of accessible half rate channels |   |   |   |   |   |   |   | octet 4<br>octet 5 |

Octets 2 and 3 give a 16 bit binary representation of the total number of full rate channels accessible (i.e. available for service or currently assigned).

Octets 4 and 5 give a 16 bit binary representation of the number of half rate channels accessible (i.e. available for service or currently assigned). This will include half rate channels already counted in octets 2 and 3, if these correspond to full rate channels that can be used as half rate channels.

(eg. If there is an accessible half rate channel and an accessible full rate channel that can be used as two half rate channels, then the full rate count will be 1 and the half rate count will be 3).

Octets 3 and 5 are the least significant octets, and bit 1 is the least significant bit.

### 3.2.2.15 LSA Identifier

This element uniquely identifies a LSA and is of fixed length containing the following fields:

|                    |   |   |   |   |   |   |   |         |
|--------------------|---|---|---|---|---|---|---|---------|
| 8                  | 7 | 6 | 5 | 4 | 3 | 2 | 1 |         |
| Element identifier |   |   |   |   |   |   |   | octet 1 |
| Length             |   |   |   |   |   |   |   | octet 2 |
| LSA ID             |   |   |   |   |   |   |   | octet 3 |
| LSA ID cont.       |   |   |   |   |   |   |   | octet 4 |
| LSA ID cont.       |   |   |   |   |   |   |   | octet 5 |

The octets 3-5 are coded as specified in 3GPP TS 43.003 [2], 'Identification of Localised Service Area'. Bit 8 of octet 3 is the MSB.

### 3.2.2.16 LSA Identifier List

This element uniquely identifies LSAs and is of variable length containing the following fields:

|                      |   |   |   |   |   |    |   |            |
|----------------------|---|---|---|---|---|----|---|------------|
| 8                    | 7 | 6 | 5 | 4 | 3 | 2  | 1 |            |
| Element identifier   |   |   |   |   |   |    |   | octet 1    |
| Length               |   |   |   |   |   |    |   | octet 2    |
| Spare                |   |   |   |   |   | EP |   | octet 3    |
| LSA identification 1 |   |   |   |   |   |    |   | octet 4-6  |
| ⋮                    |   |   |   |   |   |    |   | ⋮          |
| LSA identification n |   |   |   |   |   |    |   | .. to 3+3n |

The coding of octet 2 is a binary number indicating the length of the remaining element. The length depends on the number of LSAs to be identified. If the escape PLMN (see 3GPP TS 43.073 [40]) is broadcast the EP bit (bit 1 of octet 3) is set to 1, otherwise it is set to 0.

|              |   |   |   |   |   |   |   |           |
|--------------|---|---|---|---|---|---|---|-----------|
| 8            | 7 | 6 | 5 | 4 | 3 | 2 | 1 |           |
| LSA ID       |   |   |   |   |   |   |   | octet x+1 |
| LSA ID cont. |   |   |   |   |   |   |   | octet x+2 |
| LSA ID cont. |   |   |   |   |   |   |   | octet x+3 |

Where  $x = 3 + 3(i-1)$

The octets (x+1)-(x+3) are coded as shown in 3GPP TS 43.003 [2], 'Identification of Localised Service Area'. Bit 8 of octet (x+1) is the MSB.

### 3.2.2.17 Cell Identifier

This element uniquely identifies a cell within a BSS and is of variable length containing the following fields:

|                     |   |   |   |                                   |   |   |   |             |
|---------------------|---|---|---|-----------------------------------|---|---|---|-------------|
| 8                   | 7 | 6 | 5 | 4                                 | 3 | 2 | 1 |             |
| Element identifier  |   |   |   |                                   |   |   |   | octet 1     |
| Length              |   |   |   |                                   |   |   |   | octet 2     |
| Spare               |   |   |   | Cell identification discriminator |   |   |   | octet 3     |
| Cell identification |   |   |   |                                   |   |   |   | octet 4 - n |

The coding of octet 2 is a binary number indicating the length of the remaining element. The length depends on the Cell identification discriminator (octet 3).

The coding of "Cell identification discriminator" (bits 1 to 4 of octet 3) is a binary number indicating if the whole or a part of Cell Global Identification, CGI, according to 3GPP TS 43.003 [2] is used for cell identification in octet 4-n. The "Cell identification discriminator" is coded as follows:

|      |   |
|------|---|
| 0000 | The whole Cell Global Identification, CGI, is used to identify the cell.                                |
| 0001 | Location Area Code, LAC, and Cell Identity, CI, is used to identify the cell.                           |
| 0010 | Cell Identity, CI, is used to identify the cell.  |
| 0011 | No cell is associated with the transaction.   |
| 1000 | Intersystem Handover to UTRAN or cdma2000. PLMN-ID, LAC and RNC-ID, is used to identify the target RNC. |
| 1001 | Intersystem Handover to UTRAN or cdma2000. The RNC-ID is coded to identify the target RNC.              |
| 1010 | Intersystem Handover to UTRAN or cdma2000. LAC and RNC-ID are encoded to identify the target RNC.       |
| 1011 | Serving Area Identity, SAI, is used to identify the Serving Area of UE within UTRAN or cdma2000.        |

All other values are reserved.

The coding of octet 4-n depends on the Cell identification discriminator (octet 3). Below the coding is shown for each Cell identification discriminator:

NOTE: no coding is specified for a Cell identification discriminator value of "0011" as no additional information is required.

Coding of Cell Identification for Cell identification discriminator = 0000

For GSM 900 and DCS 1800:

|               |   |   |   |           |   |   |   |          |
|---------------|---|---|---|-----------|---|---|---|----------|
| 8             | 7 | 6 | 5 | 4         | 3 | 2 | 1 |          |
| MCC dig 2     |   |   |   | MCC dig 1 |   |   |   | octet 4  |
| 1             | 1 | 1 | 1 | MCC dig 3 |   |   |   | octet 5  |
| MNC dig 2     |   |   |   | MNC dig 1 |   |   |   | octet 6  |
| LAC           |   |   |   |           |   |   |   | octet 7  |
| LAC cont.     |   |   |   |           |   |   |   | octet 8  |
| CI value      |   |   |   |           |   |   |   | octet 9  |
| CI value cont |   |   |   |           |   |   |   | octet 10 |

The octets 4 - 8 are coded as shown in 3GPP TS 24.008 [6], Table 'Location Area Identification information element'.

The octets 9 - 10 are coded as shown in 3GPP TS 24.008 [6], Table 'Cell Identity information element'.

For PCS 1900 for NA:

|               |   |   |   |           |   |   |   |          |
|---------------|---|---|---|-----------|---|---|---|----------|
| 8             | 7 | 6 | 5 | 4         | 3 | 2 | 1 |          |
| MCC dig 2     |   |   |   | MCC dig 1 |   |   |   | octet 4  |
| MNC dig 3     |   |   |   | MCC dig 3 |   |   |   | octet 5  |
| MNC dig 2     |   |   |   | MNC dig 1 |   |   |   | octet 6  |
| LAC           |   |   |   |           |   |   |   | octet 7  |
| LAC cont.     |   |   |   |           |   |   |   | octet 8  |
| CI value      |   |   |   |           |   |   |   | octet 9  |
| CI value cont |   |   |   |           |   |   |   | octet 10 |

The octets 4 - 8 are coded as shown in 3GPP TS 24.008 [6], Table 'Location Area Identification information element'.

The octets 9 - 10 are coded as shown in 3GPP TS 24.008 [6], Table 'Cell Identity information element'.

Coding of Cell Identification for Cell identification discriminator = 0001

|               |   |   |   |   |   |   |   |         |
|---------------|---|---|---|---|---|---|---|---------|
| 8             | 7 | 6 | 5 | 4 | 3 | 2 | 1 |         |
| LAC           |   |   |   |   |   |   |   | octet 4 |
| LAC cont.     |   |   |   |   |   |   |   | octet 5 |
| CI value      |   |   |   |   |   |   |   | octet 6 |
| CI value cont |   |   |   |   |   |   |   | octet 7 |

Coding of Cell Identification for Cell identification discriminator = 0010

|               |   |   |   |   |   |   |   |         |
|---------------|---|---|---|---|---|---|---|---------|
| 8             | 7 | 6 | 5 | 4 | 3 | 2 | 1 |         |
| CI value      |   |   |   |   |   |   |   | octet 4 |
| CI value cont |   |   |   |   |   |   |   | octet 5 |

The octets 4 - 5 are coded as shown in 3GPP TS 24.008 [6], Table 'Cell Identity information element'

Cell identification discriminator = 1000

For intersystem handover from GSM to UMTS or cdma2000:

|              |   |   |   |           |   |   |   |          |
|--------------|---|---|---|-----------|---|---|---|----------|
| 8            | 7 | 6 | 5 | 4         | 3 | 2 | 1 |          |
| MCC dig 2    |   |   |   | MCC dig 1 |   |   |   | octet 4  |
| MNC dig 3    |   |   |   | MCC dig 3 |   |   |   | octet 5  |
| MNC dig 2    |   |   |   | MNC dig 1 |   |   |   | octet 6  |
| LAC          |   |   |   |           |   |   |   | octet 7  |
| LAC cont.    |   |   |   |           |   |   |   | octet 8  |
| RNC-ID       |   |   |   |           |   |   |   | octet 9  |
| RNC-ID cont. |   |   |   |           |   |   |   | octet 10 |

The octets 4 - 8 are coded as shown in 3GPP TS 24.008 [6], Table 'Location Area Identification information element'.

The octet 5 bits 5 - 8 are filled by '1111' if 2 digit MNC is used.



The octets 9 - 10 are coded as the RNC-ID, specified in 3GPP TS 25.413 [31] in subclause 9.2.1.25 in the Table "Target ID". The least significant bit of RNC-ID is octet 10 bit 1 and most significant bit is octet 9 bit 4. In the octet 9 bits 5-8 are filled by '0000'.

Cell identification discriminator = 1001

For intersystem handover from GSM to UMTS or cdma2000:

|              |   |   |   |   |   |   |   |         |
|--------------|---|---|---|---|---|---|---|---------|
| 8            | 7 | 6 | 5 | 4 | 3 | 2 | 1 |         |
| RNC-ID       |   |   |   |   |   |   |   | octet 4 |
| RNC-ID cont. |   |   |   |   |   |   |   | octet 5 |

The octets 4 - 5 are coded as the RNC-ID, specified in 3GPP TS 25.413 [31] in section 9.2.1.25 in the Table "Target ID". The least significant bit of RNC-ID is octet 5 bit 1 and most significant bit is octet 4 bit 4. In the octet 4 bits 5-8 are filled by '0000'.

Cell identification discriminator = 1010

For intersystem handover from GSM to UMTS or cdma2000:

|              |   |   |   |   |   |   |   |         |
|--------------|---|---|---|---|---|---|---|---------|
| 8            | 7 | 6 | 5 | 4 | 3 | 2 | 1 |         |
| LAC          |   |   |   |   |   |   |   | octet 4 |
| LAC cont.    |   |   |   |   |   |   |   | octet 5 |
| RNC-ID       |   |   |   |   |   |   |   | octet 6 |
| RNC-ID cont. |   |   |   |   |   |   |   | octet 7 |

The octets 4 - 5 are coded as shown in 3GPP TS 24.008 [6], Table 'Location Area Identification information element'.

The octets 6 - 7 are coded as the RNC-ID, specified in 3GPP TS 25.413 [31] in section 9.2.1.25 in the Table "Target ID". The least significant bit of RNC-ID is octet 7 bit 1 and most significant bit is octet 6 bit 4. In the octet 6 bits 5-8 are filled by '0000'.

Coding of the SAI for

Cell identification discriminator = 1011

The coding of SAI is defined in 3GPP TS 25.413 [31] " UTRAN Iu Interface RANAP Signalling ", without the protocol extension container.

### 3.2.2.18 Priority

This element indicates the priority of the request. It is coded as follows:

|                    |   |   |   |   |   |   |   |         |
|--------------------|---|---|---|---|---|---|---|---------|
| 8                  | 7 | 6 | 5 | 4 | 3 | 2 | 1 |         |
| Element identifier |   |   |   |   |   |   |   | octet 1 |
| Length             |   |   |   |   |   |   |   | octet 2 |
| Priority           |   |   |   |   |   |   |   | octet 3 |

Octet 2 is a binary indication of the length of the rest of the element.

Octet 3 is coded as follows:

|       |     |                |   |   |   |    |     |         |
|-------|-----|----------------|---|---|---|----|-----|---------|
| 8     | 7   | 6              | 5 | 4 | 3 | 2  | 1   |         |
| spare | pci | priority level |   |   |   | qa | pvi | octet 3 |

Bit 8 is spare, set to 0

pci = Preemption Capability indicator (see note)

- 0 this allocation request shall not preempt an existing connection
- 1 this allocation request may preempt an existing connection

priority level:

|         |  |
|---------|--|
| 6 5 4 3 |  |
| 0 0 0 0 | spare                                      |
| 0 0 0 1 | priority level 1 = highest priority        |
| 0 0 1 0 | priority level 2 = second highest priority |
| :: ::   |  |
| 1 1 1 0 | priority level 14 = lowest priority        |
| 1 1 1 1 | priority not used                          |

qa = queuing allowed indicator

|   |                     |
|---|---------------------|
| 0 | queuing not allowed |
| 1 | queuing allowed     |

pvi = Preemption Vulnerability indicator (see note)

|   |  |
|---|--|
| 0 | this connection shall not be preempted by another allocation request |
| 1 | this connection might be preempted by another allocation request     |

NOTE: Preemption Capability indicator applies to the allocation of resources for an event and as such it provides the trigger to the preemption procedures/processes of the BSS. Preemption Vulnerability indicator applies for the entire duration of a connection and as such indicates whether the connection is a target of the preemption procedures/processes of the BSS.

### 3.2.2.19 Classmark Information Type 2

The classmark information type 2 defines certain attributes of the mobile station equipment in use on a particular transaction.

It is coded as follows:

|                    |   |   |   |   |   |   |   |             |
|--------------------|---|---|---|---|---|---|---|-------------|
| 8                  | 7 | 6 | 5 | 4 | 3 | 2 | 1 |             |
| Element identifier |   |   |   |   |   |   |   | octet 1     |
| Length             |   |   |   |   |   |   |   | octet 2     |
| Classmark          |   |   |   |   |   |   |   | octet 3 - 5 |

Octet 2 is a binary indication of the length of the remainder of the element in octets. The length shall be determined by the length of the Mobile Station Classmark 2 element of 3GPP TS 24.008 [6].

The classmark octets 3, 4 and 5 are coded in the same way as the equivalent octets in the Mobile station classmark 2 element of 3GPP TS 24.008 [6].

### 3.2.2.20 Classmark Information Type 3

The classmark information type 3 defines certain attributes of the mobile station equipment in use on a particular transaction.

It is coded as follows:

|                    |   |   |   |   |   |   |   |              |
|--------------------|---|---|---|---|---|---|---|--------------|
| 8                  | 7 | 6 | 5 | 4 | 3 | 2 | 1 |              |
| Element identifier |   |   |   |   |   |   |   | octet 1      |
| Length             |   |   |   |   |   |   |   | octet 2      |
| Classmark          |   |   |   |   |   |   |   | octet 3 - 14 |

Octet 2 is a binary indication of the length of the remainder of the element in octets. The length octet has a minimum value of 1 and a maximum of 12. The length shall be determined by the length of the Mobile Station Classmark 3 element of 3GPP TS 24.008 [6].

The classmark octets 3 to 14 are coded in the same way as the equivalent octets in the Mobile station classmark 3 element of 3GPP TS 24.008 [6].

### 3.2.2.21 Interference Band To Be Used

This fixed length element is coded as follows:

|                    |   |   |   |   |   |   |   |
|--------------------|---|---|---|---|---|---|---|
| 8                  | 7 | 6 | 5 | 4 | 3 | 2 | 1 |
| Element identifier |   |   |   |   |   |   |   |
| Band to be used    |   |   |   |   |   |   |   |

octet 1  
octet 2

Octet 2 is coded as:

Bits 876 Spare  
 Bits 54321 A bit map indicating which interference bands are acceptable, the LSB represents the least level of interference.

### 3.2.2.22 RR Cause

This fixed length element is passed from the radio interface to the MSC transparently, when received in a 3GPP TS 24.008 [6] message.

|                    |   |   |   |   |   |   |   |
|--------------------|---|---|---|---|---|---|---|
| 8                  | 7 | 6 | 5 | 4 | 3 | 2 | 1 |
| Element identifier |   |   |   |   |   |   |   |
| RR cause           |   |   |   |   |   |   |   |

octet 1  
octet 2

Octet 2 is coded as the equivalent field from 3GPP TS 24.008 [6].

### 3.2.2.23 LSA Information

This element uniquely identifies LSAs, the priority, the preferential access indicator and the active mode support indicator of each LSA. The access right outside these LSAs is also defined. The element is of variable length containing the following fields:

|                                     |   |   |   |   |   |   |          |
|-------------------------------------|---|---|---|---|---|---|----------|
| 8                                   | 7 | 6 | 5 | 4 | 3 | 2 | 1        |
| Element identifier                  |   |   |   |   |   |   |          |
| Length                              |   |   |   |   |   |   |          |
| Spare                               |   |   |   |   |   |   | LSA only |
| LSA identification and attributes 1 |   |   |   |   |   |   |          |
| ⋮                                   |   |   |   |   |   |   |          |
| LSA identification and attributes n |   |   |   |   |   |   |          |

octet 1  
octet 2  
octet 3  
octet 4-7  
.. to 3+4n

The coding of octet 2 is a binary number indicating the length of the remaining element. The length depends on the number of LSAs to be identified.

If the LSA only access indicator (bit 1 of octet 3) is set to 1 the subscriber has only access to the LSAs that are defined by the LSA Information element. The LSA only access indicator is set to 0 for allowing an emergency call.

Coding of the i-th LSA identification with attributes:

|              |   |     |      |          |   |   |   |
|--------------|---|-----|------|----------|---|---|---|
| 8            | 7 | 6   | 5    | 4        | 3 | 2 | 1 |
| spare        |   | act | pref | priority |   |   |   |
| LSA ID       |   |     |      |          |   |   |   |
| LSA ID cont. |   |     |      |          |   |   |   |
| LSA ID cont. |   |     |      |          |   |   |   |

octet x+1  
octet x+2  
octet x+3  
octet x+4

Where  $x = 3 + 4(i-1)$

Bits 1 to 4 of octet (x+1) define the priority of the LSA identification.

Bit 4321  
 0000 priority 1 = lowest priority  
 0001 priority 2 = second lowest priority  
 ::::

1111 priority 16 = highest priority

If the preferential access indicator (bit 5 of octet (x+1)) is set to 1 the subscriber has preferential access in the LSA. If the active mode support indicator (bit 6 of octet (x+1)) is set to 1 the subscriber has active mode support in the LSA.

The octets (x+2)-(x+4) are coded as specified in 3GPP TS 43.003 [2], 'Identification of Localised Service Area'. Bit 8 of octet (x+2) is the MSB.

### 3.2.2.24 Layer 3 Information

This is a variable length element used to pass radio interface messages from one network entity to another.

|                     |   |   |   |   |   |   |   |             |
|---------------------|---|---|---|---|---|---|---|-------------|
| 8                   | 7 | 6 | 5 | 4 | 3 | 2 | 1 |             |
| Element identifier  |   |   |   |   |   |   |   | octet 1     |
| Length              |   |   |   |   |   |   |   | octet 2     |
| Layer 3 information |   |   |   |   |   |   |   | octet 3 - n |

Octet 1 identifies the element. Octet 2 gives the length of the following layer 3 information.

Octet j (j = 3, 4, ..., n) is the unchanged octet j-2 of either:

- a radio interface layer 3 message as defined in 3GPP TS 44.018 [32] or,
- Handover To UTRAN Command as defined in UMTS 25.331, where n-2 is equal to the length of that radio interface layer 3 message.

### 3.2.2.25 DLCI

This is a fixed length element indicating the radio interface SAPI.

|                    |   |   |   |   |   |   |   |         |
|--------------------|---|---|---|---|---|---|---|---------|
| 8                  | 7 | 6 | 5 | 4 | 3 | 2 | 1 |         |
| Element identifier |   |   |   |   |   |   |   | octet 1 |
| DLCI               |   |   |   |   |   |   |   | octet 2 |

Octet 2 is coded as the DLCI octet described in 08.06.

### 3.2.2.26 Downlink DTX Flag

A fixed length element indicating whether the DTX function in the BSS is to be disabled on a particular radio channel.

|                    |   |   |   |   |   |   |   |         |
|--------------------|---|---|---|---|---|---|---|---------|
| 8                  | 7 | 6 | 5 | 4 | 3 | 2 | 1 |         |
| Element identifier |   |   |   |   |   |   |   | octet 1 |
| Downlink DTX flag  |   |   |   |   |   |   |   | octet 2 |

The Downlink DTX Flag is coded as follows:

- bits 8 to 2 are spare;
- bit 1 is set to one if the MSC forbids the BSS to activate DTX in the downlink direction; it is set to 0 otherwise.

### 3.2.2.27 Cell Identifier List

This element uniquely identifies cells and is of variable length containing the following fields:

| 8                     | 7 | 6 | 5 | 4                                 | 3 | 2 | 1 |             |
|-----------------------|---|---|---|-----------------------------------|---|---|---|-------------|
| Element identifier    |   |   |   |                                   |   |   |   | octet 1     |
| Length                |   |   |   |                                   |   |   |   | octet 2     |
| Spare                 |   |   |   | Cell identification discriminator |   |   |   | octet 3     |
| Cell identification 1 |   |   |   |                                   |   |   |   | octet 4-4+m |
| ⋮                     |   |   |   |                                   |   |   |   |             |
| Cell identification n |   |   |   |                                   |   |   |   | .. to 4+n   |

The coding of octet 2 is a binary number indicating the Length of the remaining element. The Length depends on the Cell identification discriminator (bits 1 to 4 of octet 3) as well as the number of cells to be identified.

The coding of the Cell identification discriminator is a binary number indicating if the whole or a part of Cell Global identification, CGI, according to 3GPP TS 43.003 [2] is used for cell identification of the cells in the list. The Cell identification discriminator is coded as follows:

|      |  |
|------|--|
| 0000 | The whole Cell Global Identification, CGI, is used to identify the cells.                                    |
| 0001 | Location Area Code, LAC, and Cell Identify, CI, is used to identify the cells.                               |
| 0010 | Cell Identity, CI, is used to identify the cells.  |
| 0011 | No cell is associated with the transaction.  |
| 0100 | Location Area Identification, LAI, is used to identify all cells within a Location Area.                     |
| 0101 | Location Area Code, LAC, is used to identify all cells within a location area.                               |
| 0110 | All cells on the BSS are identified.   |
| 1000 | Intersystem Handover to UTRAN or cdma2000. PLMN-ID, LAC, and RNC-ID, are encoded to identify the target RNC. |
| 1001 | Intersystem Handover to UTRAN or cdma2000. The RNC-ID is coded to identify the target RNC.                   |
| 1010 | Intersystem Handover to UTRAN or cdma2000. LAC and RNC-ID are encoded to identify the target RNC.            |

All other values are reserved.

Values 0100, 0101 and 0110 are only applicable for page message.

The coding of the Cell Identifications 1 to n (octets 4 to 4+nm) depends on the Cell identification discriminator (octet 3). Below the coding of the i-th Cell Identification is shown for each Cell identification discriminator (with "i" in the range 1 to n):

NOTE: no coding is specified for Cell identification discriminator values of "0011" and "0110" as no additional information is required.

Coding of the i-th Cell Identification for Cell identification discriminator = 0000

For GSM 900 and DCS 1800:

| 8             | 7 | 6 | 5 | 4         | 3 | 2 | 1 |           |
|---------------|---|---|---|-----------|---|---|---|-----------|
| MCC dig 2     |   |   |   | MCC dig 1 |   |   |   | octet x+1 |
| 1             | 1 | 1 | 1 | MCC dig 3 |   |   |   | octet x+2 |
| MNC dig 2     |   |   |   | MNC dig 1 |   |   |   | octet x+3 |
| LAC           |   |   |   |           |   |   |   | octet x+4 |
| LAC cont.     |   |   |   |           |   |   |   | octet x+5 |
| CI value      |   |   |   |           |   |   |   | octet x+6 |
| CI value cont |   |   |   |           |   |   |   | octet x+7 |

Where  $x = 3 + 7(i-1)$ .

The octets (x+1)-(x+5) are coded as shown in 3GPP TS 24.008 [6], Table 'Location Area Identification information element'.

The octets (x+6)-(x+7) are coded as shown in 3GPP TS 24.008 [6], Table 'Cell Identity information element'.

For PCS 1900 for NA:

|               |   |   |   |           |   |   |   |           |
|---------------|---|---|---|-----------|---|---|---|-----------|
| 8             | 7 | 6 | 5 | 4         | 3 | 2 | 1 |           |
| MCC dig 2     |   |   |   | MCC dig 1 |   |   |   | octet x+1 |
| MCC dig 3     |   |   |   | MCC dig 3 |   |   |   | octet x+2 |
| MNC dig 2     |   |   |   | MNC dig 1 |   |   |   | octet x+3 |
| LAC           |   |   |   |           |   |   |   | octet x+4 |
| LAC cont.     |   |   |   |           |   |   |   | octet x+5 |
| CI value      |   |   |   |           |   |   |   | octet x+6 |
| CI value cont |   |   |   |           |   |   |   | octet x+7 |

Where  $x = 3 + 7(i-1)$ .

The octets (x+1)-(x+5) are coded as shown in 3GPP TS 24.008 [6], Table 'Location Area Identification information element'.

The octets (x+6)-(x+7) are coded as shown in 3GPP TS 24.008 [6], Table 'Cell Identity information element' .

Coding of i-th Cell Identification for  
Cell identification discriminator = 0001

|               |   |   |   |   |   |   |   |           |
|---------------|---|---|---|---|---|---|---|-----------|
| 8             | 7 | 6 | 5 | 4 | 3 | 2 | 1 |           |
| LAC           |   |   |   |   |   |   |   | octet x+1 |
| LAC cont.     |   |   |   |   |   |   |   | octet x+2 |
| CI value      |   |   |   |   |   |   |   | octet x+3 |
| CI value cont |   |   |   |   |   |   |   | octet x+4 |

Where  $x = 3 + 4(i-1)$

The octets (x+1)-(x+2) are coded as shown in 3GPP TS 24.008 [6], Table 'Location Area Identification information element'.

The octets (x+3)-(x+4) are coded as shown in 3GPP TS 24.008 [6], Table 'Cell Identity information element'.

Coding of i-th Cell Identification for Cell identification discriminator = 0010

|               |   |   |   |   |   |   |   |           |
|---------------|---|---|---|---|---|---|---|-----------|
| 8             | 7 | 6 | 5 | 4 | 3 | 2 | 1 |           |
| CI value      |   |   |   |   |   |   |   | octet x+1 |
| CI value cont |   |   |   |   |   |   |   | octet x+2 |

Where  $x = 3 + 2(i-1)$

The octets (x+1)-(x+2) are coded as shown in 3GPP TS 24.008 [6], Table 'Cell Identity information element' .

Coding of i-th Cell Identification for Cell identification discriminator = 0100

For GSM 900 and DCS 1800:

|           |   |   |   |           |   |   |   |           |
|-----------|---|---|---|-----------|---|---|---|-----------|
| 8         | 7 | 6 | 5 | 4         | 3 | 2 | 1 |           |
| MCC dig 2 |   |   |   | MCC dig 1 |   |   |   | octet x+1 |
| 1         | 1 | 1 | 1 | MCC dig 3 |   |   |   | octet x+2 |
| MNC dig 2 |   |   |   | MNC dig 1 |   |   |   | octet x+3 |
| LAC       |   |   |   |           |   |   |   | octet x+4 |
| LAC cont. |   |   |   |           |   |   |   | octet x+5 |

Where  $x = 3 + 5(i-1)$

The octets (x+1)-(x+5) are coded as shown in 3GPP TS 24.008 [6], Table 'Location Area Identification information element'.

For PCS 1900 for NA:

|           |   |   |   |           |   |   |   |           |
|-----------|---|---|---|-----------|---|---|---|-----------|
| 8         | 7 | 6 | 5 | 4         | 3 | 2 | 1 |           |
| MCC dig 2 |   |   |   | MCC dig 1 |   |   |   | octet x+1 |
| MCC dig 3 |   |   |   | MCC dig 3 |   |   |   | octet x+2 |
| MNC dig 2 |   |   |   | MNC dig 1 |   |   |   | octet x+3 |
| LAC       |   |   |   |           |   |   |   | octet x+4 |
| LAC cont. |   |   |   |           |   |   |   | octet x+5 |

Where  $x = 3 + 5(i-1)$

The octets (x+1)-(x+5) are coded as shown in 3GPP TS 24.008 [6], Table 'Location Area Identification information element'.

Coding of i-th Cell Identification for Cell identification discriminator = 0101

|           |   |   |   |   |   |   |   |           |
|-----------|---|---|---|---|---|---|---|-----------|
| 8         | 7 | 6 | 5 | 4 | 3 | 2 | 1 |           |
| LAC       |   |   |   |   |   |   |   | octet x+1 |
| LAC cont. |   |   |   |   |   |   |   | octet x+2 |

Where  $x = 3 + 2(i-1)$

The octets (x+1)-(x+2) are coded as shown in 3GPP TS 24.008 [6], Table 'Location Area Identification information element'.

The appropriate coding for not identified cells is "0" for all bits of LAC and CI for all possible Cell Identification Discriminator values.

Coding of the Target ID for Cell identification discriminator = 1000

For intersystem handover from GSM to UMTS or cdma2000:

|              |   |   |   |           |   |   |   |          |
|--------------|---|---|---|-----------|---|---|---|----------|
| 8            | 7 | 6 | 5 | 4         | 3 | 2 | 1 |          |
| MCC dig 2    |   |   |   | MCC dig 1 |   |   |   | octet 4  |
| MNC dig 3    |   |   |   | MCC dig 3 |   |   |   | octet 5  |
| MNC dig 2    |   |   |   | MNC dig 1 |   |   |   | octet 6  |
| LAC          |   |   |   |           |   |   |   | octet 7  |
| LAC cont.    |   |   |   |           |   |   |   | octet 8  |
| RNC-ID       |   |   |   |           |   |   |   | octet 9  |
| RNC-ID cont. |   |   |   |           |   |   |   | octet 10 |

The octets 4 - 8 are coded as shown in 3GPP TS 24.008 [6], Table 'Location Area Identification information element'.

The octet 5 bits 5 - 8 are filled by '1111' if 2 digit MNC is used.

The octets 9 - 10 are coded as the RNC-ID, specified in 3GPP TS 25.413 [31] in section 9.2.1.25 in the Table "Target ID". The least significant bit of RNC-ID is octet 10 bit 1 and most significant bit is octet 9 bit 4. In the octet 9 bits 5-8 are filled by '0000'.

Coding of the Target ID for Cell identification discriminator = 1001

For intersystem handover from GSM to UMTS or cdma2000:

|              |   |   |   |   |   |   |   |         |
|--------------|---|---|---|---|---|---|---|---------|
| 8            | 7 | 6 | 5 | 4 | 3 | 2 | 1 |         |
| RNC-ID       |   |   |   |   |   |   |   | octet 4 |
| RNC-ID cont. |   |   |   |   |   |   |   | octet 5 |

The octets 4 - 5 are coded as the RNC-ID, specified in 3GPP TS 25.413 [31] in section 9.2.1.25 in the Table "Target ID". The least significant bit of RNC-ID is octet 5 bit 1 and most significant bit is octet 4 bit 4. In the octet 4 bits 5-8 are filled by '0000'.

Coding of the Target ID for Cell identification discriminator = 1010

For intersystem handover from GSM to UMTS or cdma2000:

|              |   |   |   |   |   |   |   |
|--------------|---|---|---|---|---|---|---|
| 8            | 7 | 6 | 5 | 4 | 3 | 2 | 1 |
| LAC          |   |   |   |   |   |   |   |
| LAC cont.    |   |   |   |   |   |   |   |
| RNC-ID       |   |   |   |   |   |   |   |
| RNC-ID cont. |   |   |   |   |   |   |   |

octet 4  
octet 5  
octet 6  
octet 7

The octets 4 - 5 are coded as shown in 3GPP TS 24.008 [6], Table 'Location Area Identification information element'.

The octets 6 - 7 are coded as the RNC-ID, specified in 3GPP TS 25.413 [31] in section 9.2.1.25 in the Table "Target ID". The least significant bit of RNC-ID is octet 7 bit 1 and most significant bit is octet 6 bit 4. In the octet 6 bits 5-8 are filled by '0000'.

### 3.2.2.28 Response Request

The presence of this element indicates that a Handover Required Reject message is required by the BSS, if the Handover Required message does not result in a handover.

The element has a fixed length of one octet:

|                    |   |   |   |   |   |   |   |
|--------------------|---|---|---|---|---|---|---|
| 8                  | 7 | 6 | 5 | 4 | 3 | 2 | 1 |
| Element identifier |   |   |   |   |   |   |   |

octet 1

### 3.2.2.29 Resource Indication Method

This element defines the way the BSS shall transfer the resource information related to a cell to the MSC. The coding is as follows:

|                    |   |   |   |                            |   |   |   |
|--------------------|---|---|---|----------------------------|---|---|---|
| 8                  | 7 | 6 | 5 | 4                          | 3 | 2 | 1 |
| Element identifier |   |   |   |                            |   |   |   |
| Spare              |   |   |   | Resource indication method |   |   |   |

octet 1  
octet 2

The coding of the Resource Indication parameter is:

|      |   |
|------|---|
| 0000 | the method i) of subclause 3.1.3.1 is selected,   |
| 0001 | the method ii) of subclause 3.1.3.1 is selected,  |
| 0010 | the method iii) of subclause 3.1.3.1 is selected, |
| 0011 | the method iv) of subclause 3.1.3.1 is selected.  |

All other values are reserved.

### 3.2.2.30 Classmark Information Type 1

The classmark information type 1 defines certain attributes of the mobile station equipment in use on a particular transaction.

It is coded as follows:

|                    |   |   |   |   |   |   |   |
|--------------------|---|---|---|---|---|---|---|
| 8                  | 7 | 6 | 5 | 4 | 3 | 2 | 1 |
| Element identifier |   |   |   |   |   |   |   |
| Classmark          |   |   |   |   |   |   |   |

octet 1  
octet 2

The classmark octet 2 is coded in the same way as the equivalent octet in the classmark 1 element of 3GPP TS 24.008 [6].



### 3.2.2.31 Circuit Identity Code List

This element defines in conjunction with a Circuit Identity Code (3.2.2.2.) a list of terrestrial channels.

|                    |   |   |   |   |   |   |   |            |
|--------------------|---|---|---|---|---|---|---|------------|
| 8                  | 7 | 6 | 5 | 4 | 3 | 2 | 1 |            |
| Element identifier |   |   |   |   |   |   |   | octet 1    |
| Length             |   |   |   |   |   |   |   | octet 2    |
| Range              |   |   |   |   |   |   |   | octet 3    |
| Status             |   |   |   |   |   |   |   | octet 4-35 |

The following codes are used in the range and status fields:

#### Range:

A number in pure binary representation ranging from 0 to 255. The number represented by the range code +1 indicates the range of circuits affected by the message.

#### Status:

The Status subfield contains up to 256 Status bits numbered from 0 up to 255. Status bit 0 is located in bit position 1 of the first Status subfield octet and refers to the circuit indicated in the CIC subfield {should be "associated Circuit Identity Code Information Element" not "CIC subfield"} itself. Other Status bits follow in numerical order.

Each Status bit is associated with a circuit identification code such that Status bit  $n$  is associated with CIC  $m+n$ , where  $m$  is the CIC contained in the message. {"where  $m$  is the CIC identified in the associated Circuit Identity Code Information Element in the message" }

Status bit  $n$  is located in bit position  $nb$  of the  $no$ -th octet of the Status subfield with:

$$\begin{aligned} nb &= (n \bmod 8) + 1 \\ \text{and} \\ no &= (n \div 8) + 1. \end{aligned}$$

The number of relevant Status bits in a given Status subfield is equal to the range value +1.

The Status bits are coded as follows:

- in the CIRCUIT GROUP BLOCK message
  - 0 no indication
  - 1 block
- in the CIRCUIT GROUP BLOCKING ACKNOWLEDGE message
  - 0 no indication
  - 1 blocking acknowledgement
- in the CIRCUIT GROUP UNBLOCK message
  - 0 no indication
  - 1 unblock
- in the CIRCUIT GROUP UNBLOCKING ACKNOWLEDGE message
  - 0 no indication
  - 1 unblocking acknowledgement
- in the UNEQUIPPED CIRCUIT message
  - 0 no indication
  - 1 unequipped

### 3.2.2.32 Diagnostics

|                    |   |   |   |   |   |   |   |
|--------------------|---|---|---|---|---|---|---|
| 8                  | 7 | 6 | 5 | 4 | 3 | 2 | 1 |
| Element identifier |   |   |   |   |   |   |   |
| Length             |   |   |   |   |   |   |   |
| Error pointer      |   |   |   |   |   |   |   |
| Message received   |   |   |   |   |   |   |   |

octet 1  
octet 2  
octet 3-4  
octet 5-n

The coding of the error pointer field is as follows:

Octet 3 gives the number of octets between octet 4 (not included) and the first octet (included) of the part of the message received which provoked the error. Thus:

|           |   |
|-----------|---|
| 0000 0000 | Error location not determined   |
| 0000 0001 | The first octet of the message received (i.e. the message type) was found erroneous (unknown) |
| 0000 0010 | The second octet of the message received was found erroneous                                  |
| 0000 0011 | The third octet of the message received was found erroneous                                   |
| etc.      |   |

The last three values are reserved for the BSSAP header:

|           |   |
|-----------|---|
| 1111 1101 | The first octet of the BSSAP header (Discrimination) was found erroneous    |
| 1111 1110 | (DTAP only) The DLCI (second) octet of the BSSAP header was found erroneous |
| 1111 1111 | The last octet of the BSSAP header (length indicator) was found erroneous   |

Octet 4 is coded as follows:

|     |       |   |   |   |             |   |   |   |
|-----|-------|---|---|---|-------------|---|---|---|
| bit | 8     | 7 | 6 | 5 | 4           | 3 | 2 | 1 |
|     | 0     | 0 | 0 | 0 | bit pointer |   |   |   |
|     | spare |   |   |   |             |   |   |   |

The bit pointer field is coded as follows:

|      |  |
|------|--|
| bits | 4321   |
| 0000 | No particular part of the octet is indicated                                       |
| 0001 | An error was provoked by the field whose most significant bit is in bit position 1 |
| 0010 | An error was provided by the field whose most significant bit is in bit position 2 |
| 0011 | An error was provided by the field whose most significant bit is in bit position 3 |
| 0100 | An error was provided by the field whose most significant bit is in bit position 4 |
| 0101 | An error was provided by the field whose most significant bit is in bit position 5 |
| 0110 | An error was provided by the field whose most significant bit is in bit position 6 |
| 0111 | An error was provided by the field whose most significant bit is in bit position 7 |
| 1000 | An error was provided by the field whose most significant bit is in bit position 8 |

All other values are reserved.

The "message received" field should be the contents, as far as can be determined, of the received message which provoked the error.

### 3.2.2.33 Chosen Channel

This Information Element contains a description of the channel allocated to the MS.

For VGCS/VBS calls this Information Element contains a description of the channel allocated for the call in the cell.

It is coded as follows:

|                    |   |   |   |         |   |   |   |
|--------------------|---|---|---|---------|---|---|---|
| 8                  | 7 | 6 | 5 | 4       | 3 | 2 | 1 |
| Element identifier |   |   |   |         |   |   |   |
| Channel mode       |   |   |   | Channel |   |   |   |

octet 1  
octet 2

The channel mode field is coded as follows:

| Bit  | meaning   |
|------|---|
| 0000 | no channel mode indication                        |
| 1001 | speech (full rate or half rate)                   |
| 1110 | data, 14.5 kbit/s radio interface rate            |
| 1011 | data, 12.0 kbit/s radio interface rate            |
| 1100 | data, 6.0 kbit/s radio interface rate             |
| 1101 | data, 3.6 kbit/s radio interface rate             |
| 1000 | signalling only                                   |
| 0001 | data, 29.0 kbit/s radio interface rate            |
| 0010 | data, 32.0 kbit/s radio interface rate            |
| 0011 | data, 43.5 kbit/s radio interface rate            |
| 0100 | data, 43.5 kbit/s downlink and 14.5 kbit/s uplink |
| 0101 | data, 29.0 kbit/s downlink and 14.5 kbit/s uplink |
| 0110 | data, 43.5 kbit/s downlink and 29.0 kbit/s uplink |
| 0111 | data, 14.5 kbit/s downlink and 43.5 kbit/s uplink |
| 1010 | data, 14.5 kbit/s downlink and 29.0 kbit/s uplink |
| 1111 | data, 29.0 kbit/s downlink and 43.5 kbit/s uplink |

All other values are reserved.

The channel field is coded as follows:

| Bit  | meaning          |
|------|------------------|
| 0000 | None (Note *)    |
| 0001 | SDCCH            |
| 1000 | 1 Full rate TCH  |
| 1001 | 1 Half rate TCH  |
| 1010 | 2 Full Rate TCHs |
| 1011 | 3 Full Rate TCHs |
| 1100 | 4 Full Rate TCHs |
| 1101 | 5 Full Rate TCHs |
| 1110 | 6 Full Rate TCHs |
| 1111 | 7 Full Rate TCHs |
| 0100 | 8 Full Rate TCHs |

NOTE \*: This value may be returned in the chosen channel information for VGCS/VBS calls in the case where the BSS has decided to de-allocate resources or allocate no resources for the call.

All other values are reserved.

### 3.2.2.34 Cipher Response Mode

This information element is used by the MSC to indicate whether the IMEI is to be included in the CIPHERING MODE COMPLETE message to be sent by the Mobile Station.

|                      |   |   |   |   |   |   |   |         |
|----------------------|---|---|---|---|---|---|---|---------|
| 8                    | 7 | 6 | 5 | 4 | 3 | 2 | 1 |         |
| Element identifier   |   |   |   |   |   |   |   | octet 1 |
| Cipher response mode |   |   |   |   |   |   |   | octet 2 |

Octet 2 is coded as:-

Bits 8,7,6,5,4,3,2 - Spare

Bit 1 = 0 - IMEISV must not be included by the Mobile Station

Bit 1 = 1 - IMEISV must be included by the Mobile Station

### 3.2.2.35 Layer 3 Message Contents

This is a variable length element used to pass the contents (from octet 3 up to the last octet) of radio interface messages from one network entity to another.

|                          |   |   |   |   |   |   |   |
|--------------------------|---|---|---|---|---|---|---|
| 8                        | 7 | 6 | 5 | 4 | 3 | 2 | 1 |
| Element identifier       |   |   |   |   |   |   |   |
| Length                   |   |   |   |   |   |   |   |
| Layer 3 message contents |   |   |   |   |   |   |   |

octet 1  
octet 2  
octet 3 - n

The length indicator (octet 2) is a binary number indicating the absolute length of the contents after the length indicator octet.

Octet  $j$  ( $j = 3, 4, \dots, n$ ) is the unchanged octet  $j$  of a radio interface layer 3 message as defined in 3GPP TS 24.008 [6],  $n$  is equal to the length of that radio interface layer 3 message.

### 3.2.2.36 Channel Needed

This information element contains an indication for the mobile station of which channel is needed for the transaction linked to the paging procedure.

It is coded as follows:

|                    |   |   |   |   |   |         |   |
|--------------------|---|---|---|---|---|---------|---|
| 8                  | 7 | 6 | 5 | 4 | 3 | 2       | 1 |
| Element identifier |   |   |   |   |   |         |   |
| Spare              |   |   |   |   |   | Channel |   |

octet 1  
octet 2

The Channel field is coded as follows:

|     |            |                            |
|-----|------------|----------------------------|
| Bit | <b>2 1</b> |                            |
|     | 0 0        | Any channel                |
|     | 0 1        | SDCCCH                     |
|     | 1 0        | TCH/F (Full rate)          |
|     | 1 1        | TCH/H or TCH/F (Dual rate) |

### 3.2.2.37 Trace Type

A fixed length element indicating the type of trace information to be recorded.

|                    |   |   |   |   |   |   |   |
|--------------------|---|---|---|---|---|---|---|
| 8                  | 7 | 6 | 5 | 4 | 3 | 2 | 1 |
| Element identifier |   |   |   |   |   |   |   |
| Trace type         |   |   |   |   |   |   |   |

octet 1  
octet 2

Octet 2 contains the trace type.

Octet 2 is coded as the MSC/BSS Trace Type specified in 3GPP TS 52.008 [41].

### 3.2.2.38 TriggerID

A variable length element indicating the identity of the entity which initiated the trace.

|                    |   |   |   |   |   |   |   |
|--------------------|---|---|---|---|---|---|---|
| 8                  | 7 | 6 | 5 | 4 | 3 | 2 | 1 |
| Element identifier |   |   |   |   |   |   |   |
| Length             |   |   |   |   |   |   |   |
| Entity identity    |   |   |   |   |   |   |   |

octet 1  
octet 2  
octets 3-22

Octets 3-22 may be typically an OMC identity.

### 3.2.2.39 Trace Reference

A fixed length element providing a trace reference number allocated by the triggering entity

|                    |   |   |   |   |   |   |   |
|--------------------|---|---|---|---|---|---|---|
| 8                  | 7 | 6 | 5 | 4 | 3 | 2 | 1 |
| Element identifier |   |   |   |   |   |   |   |
| TraceReference     |   |   |   |   |   |   |   |

octet 1  
octet 2-3

### 3.2.2.40 TransactionID

A potentially variable length element indicating a particular transaction within a trace.

|                    |   |   |   |   |   |   |   |
|--------------------|---|---|---|---|---|---|---|
| 8                  | 7 | 6 | 5 | 4 | 3 | 2 | 1 |
| Element identifier |   |   |   |   |   |   |   |
| Length             |   |   |   |   |   |   |   |
| Transaction number |   |   |   |   |   |   |   |

octet 1  
octet 2  
octet 3-4

### 3.2.2.41 Mobile Identity

A variable length element.

|                    |   |   |   |   |   |   |   |
|--------------------|---|---|---|---|---|---|---|
| 8                  | 7 | 6 | 5 | 4 | 3 | 2 | 1 |
| Element identifier |   |   |   |   |   |   |   |
| Length             |   |   |   |   |   |   |   |
| Mobile identity    |   |   |   |   |   |   |   |

octet 1  
octet 2  
octet 3-n

Octet 3-n contain either the IMSI, IMEISV or IMEI as coded in 3GPP TS 24.008 [6], not including 3GPP TS 24.008 [6] element identifier or 3GPP TS 24.008 [6] octet length value.

### 3.2.2.42 OMCID

A variable length element indicating the destination OMC to which trace information is to be sent.

|                    |   |   |   |   |   |   |   |
|--------------------|---|---|---|---|---|---|---|
| 8                  | 7 | 6 | 5 | 4 | 3 | 2 | 1 |
| Element identifier |   |   |   |   |   |   |   |
| Length             |   |   |   |   |   |   |   |
| OMC identity       |   |   |   |   |   |   |   |

octet 1  
octet 2  
octets 3-22

For the OMC identity, see 3GPP TS 52.020 [28]

### 3.2.2.43 Forward Indicator

A fixed length element indicating whether the trace is to be continued in a BSS to which the call has been handed over.

|                    |   |   |   |                   |   |   |   |
|--------------------|---|---|---|-------------------|---|---|---|
| 8                  | 7 | 6 | 5 | 4                 | 3 | 2 | 1 |
| Element identifier |   |   |   |                   |   |   |   |
| spare              |   |   |   | Forward indicator |   |   |   |

octet 1  
octet 2

Octet 2 is coded as follows:

|     |   |   |   |   |   |
|-----|---|---|---|---|---|
| bit | 4 | 3 | 2 | 1 |   |
|     | 0 | 0 | 0 | 1 | forward to subsequent BSS, no trace at MSC  |
|     | 0 | 0 | 1 | 0 | forward to subsequent BSS, and trace at MSC |

All other values are reserved.

Bits 5 - 8 are spare.

### 3.2.2.44 Chosen Encryption Algorithm

This element indicates the encryption algorithm being used by the BSS.

It is coded as follows:

|                      |   |   |   |   |   |   |   |         |
|----------------------|---|---|---|---|---|---|---|---------|
| 8                    | 7 | 6 | 5 | 4 | 3 | 2 | 1 |         |
| Element identifier   |   |   |   |   |   |   |   | octet 1 |
| Algorithm identifier |   |   |   |   |   |   |   | octet 2 |

The algorithm identifier caters for the possible future introduction of different user data encryption algorithms. It is coded as:

|           |   |
|-----------|---|
| 0000 0001 | No encryption used                        |
| 0000 0010 | GSM user data encryption version 1(A5/1). |
| 0000 0011 | GSM A5/2                                  |
| 0000 0100 | GSM A5/3                                  |
| 0000 0101 | GSM A5/4                                  |
| 0000 0110 | GSM A5/5                                  |
| 0000 0111 | GSM A5/6                                  |
| 0000 1000 | GSM A5/7                                  |

All other values are Reserved for future international use.

### 3.2.2.45 Circuit Pool

This element indicates the circuit pool of a circuit or group of circuits.

It is coded as follows:

|                     |   |   |   |   |   |   |   |         |
|---------------------|---|---|---|---|---|---|---|---------|
| 8                   | 7 | 6 | 5 | 4 | 3 | 2 | 1 |         |
| Element identifier  |   |   |   |   |   |   |   | octet 1 |
| Circuit pool number |   |   |   |   |   |   |   | octet 2 |

Predefined circuit pools are currently Circuit pool number 1 to Circuit pool number 32.

The circuit pool element is coded as follows (along with the definition of the predefined circuit pools):

| Coding    | Pool                  | Supported channels and speech coding algorithms   |
|-----------|-----------------------|---|
| 0000 0001 | Circuit pool number 1 | FR speech version 1<br>FR data (12, 6, 3.6 kbit/s)  |
| 0000 0010 | Circuit pool number 2 | HR speech version 1<br>HR data (6, 3.6 kbit/s)  |
| 0000 0011 | Circuit pool number 3 | FR speech version 1<br>FR data (12, 6, 3.6 kbit/s)<br>HR speech version 1<br>HR data (6, 3.6 kbit/s)                        |
| 0000 0100 | Circuit pool number 4 | FR speech version 2<br>FR data (12, 6, 3.6 kbit/s)  |
| 0000 0101 | Circuit pool number 5 | FR speech version 1<br>FR speech version 2<br>FR data (12, 6, 3.6 kbit/s)   |
| 0000 0110 | Circuit pool number 6 | FR speech version 2<br>FR data (12, 6, 3.6 kbit/s)<br>HR speech version 1<br>HR data (6, 3.6 kbit/s)                        |
| 0000 0111 | Circuit pool number 7 | FR speech version 1<br>FR speech version 2<br>FR data (12, 6, 3.6 kbit/s)<br>HR speech version 1<br>HR data (6, 3.6 kbit/s) |

| <b>Coding</b> | <b>Pool</b>            | <b>Supported channels and speech coding algorithms</b>  |
|---------------|------------------------|---|
| 0000 1000     | Circuit pool number 8  | HSCSD max 2 x FR data (12, 6 kbit/s)  |
| 0000 1001     | Circuit pool number 9  | FR data (12, 6, 3.6 kbit/s)<br>HR data (6, 3.6 kbit/s)<br>HSCSD max 2 x FR data (12, 6 kbit/s)  |
| 0000 1010     | Circuit pool number 10 | FR speech version 1<br>FR speech version 2<br>FR data (12, 6, 3.6 kbit/s)<br>HR speech version 1<br>HR data (6, 3.6 kbit/s)<br>HSCSD max 2 x FR data (12, 6 kbit/s)   |
| 0000 1011     | Circuit pool number 11 | HSCSD max 4 x FR data (12, 6 kbit/s)  |
| 0000 1100     | Circuit pool number 12 | FR data (12, 6, 3.6 kbit/s)<br>HR data (6, 3.6 kbit/s)<br>HSCSD max 4 x FR data (12, 6 kbit/s)  |
| 0000 1101     | Circuit pool number 13 | FR speech version 1<br>FR speech version 2<br>FR data (12, 6, 3.6 kbit/s)<br>HR speech version 1<br>HR data (6, 3.6 kbit/s)<br>HSCSD max 4 x FR data (12, 6 kbit/s)   |
| 0000 1110     | Circuit pool number 14 | HSCSD max 6 x FR data (12, 6 kbit/s)<br>EDGE max 2 x FR data (32.0 kbit/s)  |
| 0000 1111     | Circuit pool number 15 | FR data (14.5 kbit/s)   |
| 0001 0000     | Circuit pool number 16 | HSCSD max 2 x FR data (14.5 kbit/s)<br>EDGE FR data (29.0 kbit/s)   |
| 0001 0001     | Circuit pool number 17 | HSCSD max 4 x FR data (14.5 kbit/s)<br>EDGE max 2 x FR data (29.0 kbit/s)<br>EDGE FR data (43.5 kbit/s)   |
| 0001 0010     | Circuit pool number 18 | FR data (14.5, 12, 6, 3.6 kbit/s)<br>HR data (6, 3.6 kbit/s)<br>HSCSD max 2 x FR data (14.5, 12, 6 kbit/s)<br>EDGE FR data (29.0 kbit/s)  |
| 0001 0011     | Circuit pool number 19 | FR data (14.5, 12, 6, 3.6 kbit/s)<br>HR data (6, 3.6 kbit/s)<br>HSCSD max 4 x FR data (14.5, 12, 6 kbit/s)<br>EDGE max 2 x FR data (29.0 kbit/s)<br>EDGE FR data (43.5 kbit/s)  |
| 0001 0100     | Circuit pool number 20 | FR speech version 1<br>FR speech version 2<br>FR data (14.5, 12, 6, 3.6 kbit/s)<br>HR speech version 1<br>HR data (6, 3.6 kbit/s)   |
| 0001 0101     | Circuit pool number 21 | FR speech version 1<br>FR speech version 2<br>FR data (14.5, 12, 6, 3.6 kbit/s)<br>HR speech version 1<br>HR data (6, 3.6 kbit/s)<br>HSCSD max 2 x FR data (14.5, 12, 6 kbit/s)<br>EDGE FR data (29.0 kbit/s)                                       |
| 0001 0110     | Circuit pool number 22 | FR speech version 1<br>FR speech version 2<br>FR data (14.5, 12, 6, 3.6 kbit/s)<br>HR speech version 1<br>HR data (6, 3.6 kbit/s)<br>HSCSD max 4 x FR data (14.5, 12, 6 kbit/s)<br>EDGE max 2 x FR data (29.0 kbit/s)<br>EDGE FR data (43.5 kbit/s) |
| 0001 0111     | Circuit pool number 23 | FR speech version 3<br>HR speech version 3  |

| <b>Coding</b> | <b>Pool</b>            | <b>Supported channels and speech coding algorithms</b>  |
|---------------|------------------------|---|
| 0001 1000     | Circuit pool number 24 | FR speech version 3<br>FR data (12, 6, 3.6 kbit/s)<br>HR speech version 3   |
| 0001 1001     | Circuit pool number 25 | FR speech version 1<br>FR speech version 2<br>FR speech version 3<br>FR data (12, 6, 3.6 kbit/s)<br>HR speech version 3   |
| 0001 1010     | Circuit pool number 26 | FR speech version 1<br>FR speech version 2<br>FR speech version 3<br>FR data (14.5, 12, 6, 3.6 kbit/s)<br>HR speech version 3   |
| 0001 1011     | Circuit pool number 27 | FR speech version 1<br>FR speech version 2<br>FR speech version 3<br>FR data (12, 6, 3.6 kbit/s)<br>HR speech version 1<br>HR speech version 3<br>HR data (6, 3.6 kbit/s)   |
| 0001 1100     | Circuit pool number 28 | FR speech version 1<br>FR speech version 2<br>FR speech version 3<br>FR data (14.5, 12, 6, 3.6 kbit/s)<br>HR speech version 1<br>HR speech version 3<br>HR data (6, 3.6 kbit/s)   |
| 0001 1101     | Circuit pool number 29 | FR speech version 1<br>FR speech version 2<br>FR speech version 3<br>FR data (12, 6, 3.6 kbit/s)<br>HR speech version 1<br>HR speech version 3<br>HR data (6, 3.6 kbit/s)<br>HSCSD max 2 x FR data (12, 6 kbit/s)   |
| 0001 1110     | Circuit pool number 30 | FR speech version 1<br>FR speech version 2<br>FR speech version 3<br>FR data (14.5, 12, 6, 3.6 kbit/s)<br>HR speech version 1<br>HR speech version 3<br>HR data (6, 3.6 kbit/s)<br>HSCSD max 2 x FR data (14.5, 12, 6 kbit/s)<br>EDGE FR data (29.0 kbit/s) |
| 0001 1111     | Circuit pool number 31 | FR speech version 1<br>FR speech version 2<br>FR speech version 3<br>FR data (12, 6, 3.6 kbit/s)<br>HR speech version 1<br>HR speech version 3<br>HR data (6, 3.6 kbit/s)<br>HSCSD max 4 x FR data (12, 6 kbit/s)   |



| Coding   | Pool                   | Supported channels and speech coding algorithms   |
|--|------------------------|---|
| 0010 0000  | Circuit pool number 32 | FR speech version 1<br>FR speech version 2<br>FR speech version 3<br>FR data (14.5, 12, 6, 3.6 kbit/s)<br>HR speech version 1<br>HR speech version 3<br>HR data (6, 3.6 kbit/s)<br>HSCSD max 4 x FR data (14.5, 12, 6 kbit/s)<br>EDGE max 2 x FR data (29.0 kbit/s)<br>EDGE FR data (43.5 kbit/s)                                       |
| 0010 0001  | Circuit pool number 33 | FR data (14.5, 12, 6, 3.6 kbit/s)<br>HR data (6, 3.6 kbit/s)<br>HSCSD max 4 x FR data (14.5, 12, 6 kbit/s)<br>EDGE max 2 x FR data (29.0 kbit/s)<br>EDGE FR data (43.5 kbit/s)<br>EDGE max 2 x FR data (32.0 kbit/s)  |
| 0010 0010  | Circuit pool number 34 | FR speech version 1<br>FR speech version 2<br>FR data (14.5, 12, 6, 3.6 kbit/s)<br>HR speech version 1<br>HR data (6, 3.6 kbit/s)<br>HSCSD max 4 x FR data (14.5, 12, 6 kbit/s)<br>EDGE max 2 x FR data (29.0 kbit/s)<br>EDGE FR data (43.5 kbit/s)<br>EDGE max 2 x FR data (32.0 kbit/s)   |
| 0010 0011  | Circuit pool number 35 | FR speech version 1<br>FR speech version 2<br>FR speech version 3<br>FR data (14.5, 12, 6, 3.6 kbit/s)<br>HR speech version 1<br>HR speech version 3<br>HR data (6, 3.6 kbit/s)<br>HSCSD max 4 x FR data (14.5, 12, 6 kbit/s)<br>EDGE max 2 x FR data (29.0 kbit/s)<br>EDGE FR data (43.5 kbit/s)<br>EDGE max 2 x FR data (32.0 kbit/s) |
| 1000 xxxx  | For national/local use |   |
| All other values are reserved for future international use |                        |   |

### 3.2.2.46 Circuit Pool List

This element defines a list of BSS preferred circuit pools in order of preference.

It is coded as follows:

|                                     |   |   |   |   |   |   |   |           |
|-------------------------------------|---|---|---|---|---|---|---|-----------|
| 8                                   | 7 | 6 | 5 | 4 | 3 | 2 | 1 |           |
| Element identifier                  |   |   |   |   |   |   |   | octet 1   |
| Length                              |   |   |   |   |   |   |   | octet 2   |
| Circuit pool number (1st preferred) |   |   |   |   |   |   |   | octet 3   |
| ⋮                                   |   |   |   |   |   |   |   |           |
| Circuit pool number (nth preferred) |   |   |   |   |   |   |   | octet n+2 |

The Circuit pool number is coded as specified in 3.2.2.45.

### 3.2.2.47 Time Indication

This element defines the period where the information shall be valid. It is fixed length, 2 octets.

The coding is as follows:

|                    |   |   |   |   |   |   |   |         |
|--------------------|---|---|---|---|---|---|---|---------|
| 8                  | 7 | 6 | 5 | 4 | 3 | 2 | 1 |         |
| Element identifier |   |   |   |   |   |   |   | octet 1 |
| Time               |   |   |   |   |   |   |   | octet 2 |

The Time field of this Information Element message in octet 2 is coded as follows:

```

0000 0000      (note)
0000 0001
:
1111 1110      Time,
    
```

where the time is the binary value of octet 2 \* 10s (ie 10s to 2540s).

If the Time field contains the value 255 (1111 1111), the receiving entity shall consider the time as infinite.

NOTE: The value 0 has a special meaning in the Load indication procedure (refer to subclause 3.1.20).

### 3.2.2.48 Resource Situation

This element gives, for respective indicated channel type, the total number of channels accessible and the number of channels available on any given cell at the time of construction of the message.

The number of channels available may be defined in up to five interference bands, the boundaries of these bands being set by O and M as follows:

```

Interference level:  0 -----
                    Band 1
                    X1 -----
                    Band 2
                    X2 -----
                    Band 3
                    X3 -----
                    Band 4
                    X4 -----
                    Band 5
                    X5 -----
    
```

The element is coded as follows:

|   |                    |   |   |              |   |   |   |           |
|---|--------------------|---|---|--------------|---|---|---|-----------|
| 8   | 7                  | 6 | 5 | 4            | 3 | 2 | 1 |           |
| Element identifier                          |                    |   |   |              |   |   |   | octet 1   |
| Length                                      |                    |   |   |              |   |   |   | octet 2   |
| Resource and interference<br>band indicator |                    |   |   | Channel type |   |   |   | octet 3   |
| 7/15<br>ind.                                | Number of channels |   |   |              |   |   |   | octet 4   |
|   |                    |   |   |              |   |   |   | octet 4a  |
| Resource and interference<br>band indicator |                    |   |   | Channel type |   |   |   | octet 5   |
| 7/15<br>ind.                                | Number of channels |   |   |              |   |   |   | octet 6   |
|   |                    |   |   |              |   |   |   | octet 6a  |
|   |                    |   |   |              |   |   |   |           |
| Resource and interference<br>band indicator |                    |   |   | Channel type |   |   |   | octet N-1 |
| 7/15<br>ind.                                | Number of channels |   |   |              |   |   |   | octet N   |
|   |                    |   |   |              |   |   |   | octet Na  |

The length indicator is a binary representation of the length of the following element.

The Resource type octet (octets 3, 5, etc.) is coded as follows:

The Channel type field (bits 1-4 of octets 3, 5, etc.) is coded as follows:

| Bit     | meaning       |
|---------|---------------|
| 4 3 2 1 |               |
| 0 0 0 1 | SDCCH         |
| 1 0 0 0 | Full Rate TCH |
| 1 0 0 1 | Half Rate TCH |

All other values are reserved.

The Resource and interference band indicator field (bits 5-8 of octets 3, 5, etc.) is coded as follows:

| Bit     | meaning  |
|---------|--|
| 8 7 6 5 |  |
| 0 0 0 0 | Total number of channels accessible (i.e. available for service or currently assigned) |
| 0 0 0 1 | Number of channels available in interference band 1                                    |
| 0 0 1 0 | Number of channels available in interference band 2                                    |
| 0 0 1 1 | Number of channels available in interference band 3                                    |
| 0 1 0 0 | Number of channels available in interference band 4                                    |
| 0 1 0 1 | Number of channels available in interference band 5                                    |
| 1 1 1 0 | Number of channels available without supplied interference band classification         |

All other values are reserved.

The Number of channels octets (octets 4, 6, etc.) is coded as follows:

The Number of channels is a single octet element if the 7/15 indication bit (bit 8 of octets 4, 6, etc.) is set to 0. If the 7/15 indication bit is set to 1 then it is a 2 octet field. It give a 7 (or 15) bit binary representation of the number of channels with resource type as indicated in the nearest preceding resource type octet. The coding convention used when a field extends over more than one octet is defined in subclause 3.2.2.

The number of half rate channels will include half rate channels counted as full rate channels, if these correspond to full rate channels that can be used as half rate channels.

(e.g. If there is one idle half rate channel and one idle full rate channel that can be used as two half rate channels, then the full rate count will be 1 and the half rate count will be 3).

The Resource type octet and the Number of channels octet(s) are repeated for each of the resource type reported.

For each of the channel type reported, the total number of channels accessible and at least one indication of available channels shall be included.

The number of channels available without supplied interference band classification is included only in case the interference band definition is not available for the reported channel type.

### 3.2.2.49 Current Channel Type 1

This Information Element contains a description of the channel allocated to the MS.

It is coded as follows:

|                    |   |   |   |         |   |   |   |         |
|--------------------|---|---|---|---------|---|---|---|---------|
| 8                  | 7 | 6 | 5 | 4       | 3 | 2 | 1 |         |
| Element identifier |   |   |   |         |   |   |   | octet 1 |
| Channel mode       |   |   |   | Channel |   |   |   | octet 2 |

The channel mode field is coded as follows:

| Bit         | meaning                                |
|-------------|--|
| <b>8765</b> |  |
| 0000        | signalling only                        |
| 0001        | speech (full rate or half rate)        |
| 0110        | data, 14.5 kbit/s radio interface rate |
| 0011        | data, 12.0 kbit/s radio interface rate |
| 0100        | data, 6.0 kbit/s radio interface rate  |
| 0101        | data, 3.6 kbit/s radio interface rate  |
| 0111        | data, 29 kbit/s radio interface rate   |
| 1000        | data, 32 kbit/s radio interface rate   |

|      |   |
|------|---|
| 1001 | data, 43.5 kbit/s radio interface rate            |
| 0010 | data, 43.5 kbit/s downlink and 14.5 kbit/s uplink |
| 1010 | data, 29.0 kbit/s downlink and 14.5 kbit/s uplink |
| 1011 | data, 43.5 kbit/s downlink and 29.0 kbit/s uplink |
| 1100 | data, 14.5 kbit/s downlink and 43.5 kbit/s uplink |
| 1101 | data, 14.5 kbit/s downlink and 29.0 kbit/s uplink |
| 1110 | data, 29.0 kbit/s downlink and 43.5 kbit/s uplink |
| 1111 | is reserved                                       |

All other values are for future use. If the receiver receives an unknown channel mode it shall not be rejected but the receiver shall assume that the channel mode is to be changed.

The channel field is coded as follows:

| Bit         | meaning          |
|-------------|------------------|
| <b>4321</b> |                  |
| 0001        | SDCCH            |
| 1000        | 1 Full rate TCH  |
| 1001        | 1 Half rate TCH  |
| 1010        | 2 Full Rate TCHs |
| 1011        | 3 Full Rate TCHs |
| 1100        | 4 Full Rate TCHs |
| 1101        | 5 Full Rate TCHs |
| 1110        | 6 Full Rate TCHs |
| 1111        | 7 Full Rate TCHs |
| 0100        | 8 Full Rate TCHs |
| 0000        | is reserved      |

All other values are for future use. If the receiver receives a unknown channel field it shall not be rejected but the receiver shall assume that the channel is to be changed.

Consistencies between channel fields and channel modes shall not be checked.

### 3.2.2.50 Queuing Indicator

This element contains a recommendation of the BSS concerning application of queuing.

The element has a fixed length of two octets.

|                    |   |   |   |   |     |       |   |         |
|--------------------|---|---|---|---|-----|-------|---|---------|
| 8                  | 7 | 6 | 5 | 4 | 3   | 2     | 1 |         |
| Element identifier |   |   |   |   |     |       |   | octet 1 |
| spare              |   |   |   |   | qri | spare |   | octet 2 |

Octet 2 is coded as follows:

qri = queuing recommendation indicator

|   |  |
|---|--|
| 0 | it is recommended not to allow queuing |
| 1 | it is recommended to allow queuing     |

### 3.2.2.51 Speech Version

This element indicates the speech version being used by the BSS.

It is coded as follows:

|                    |                           |   |   |   |   |   |   |         |
|--------------------|---------------------------|---|---|---|---|---|---|---------|
| 8                  | 7                         | 6 | 5 | 4 | 3 | 2 | 1 |         |
| Element identifier |                           |   |   |   |   |   |   | octet 1 |
| spare              | Speech version identifier |   |   |   |   |   |   | octet 2 |

The bits 7 - 1 of octet 2 are coded in the same way as the permitted speech version identifier in the Channel type information element.

3.2.2.52 Assignment Requirement

|                        |   |   |   |   |   |   |   |
|------------------------|---|---|---|---|---|---|---|
| 8                      | 7 | 6 | 5 | 4 | 3 | 2 | 1 |
| Element identifier     |   |   |   |   |   |   |   |
| Assignment requirement |   |   |   |   |   |   |   |

octet 1  
octet 2

Octet 2

- 00000000 Delay allowed.
- 00000001 Immediate and the resources shall not be de-allocated until the end of the call (channel establishment on demand forbidden by the MSC).
- 00000010 Immediate and the resources may further be de-allocated by the BSS (channel establishment on demand forbidden by the MSC).

All other values are reserved.

3.2.2.53 Void

3.2.2.54 Talker Flag

|                    |   |   |   |   |   |   |   |
|--------------------|---|---|---|---|---|---|---|
| 8                  | 7 | 6 | 5 | 4 | 3 | 2 | 1 |
| Element identifier |   |   |   |   |   |   |   |

octet 1

3.2.2.55 Group Call Reference

It is coded as follows:

|   |   |   |   |   |   |   |   |
|---|---|---|---|---|---|---|---|
| 8   | 7 | 6 | 5 | 4 | 3 | 2 | 1 |
| Element identifier                            |   |   |   |   |   |   |   |
| Length  |   |   |   |   |   |   |   |
| Descriptive group or broadcast call reference |   |   |   |   |   |   |   |

octet 1  
octet 2  
octets 3-7

Octet 2 is a binary indication of the length of the remainder of the element in octets.

The octets 3 - 8 are coded in the same way as the octets 2-6 in the Descriptive group or broadcast call reference information element as defined in 3GPP TS 24.008 [6].

3.2.2.56 eMLPP Priority

This Information Element contains the eMLPP priority of the call.

It is coded as follows:

|                    |   |   |   |               |   |   |   |
|--------------------|---|---|---|---------------|---|---|---|
| 8                  | 7 | 6 | 5 | 4             | 3 | 2 | 1 |
| Element identifier |   |   |   |               |   |   |   |
| spare              |   |   |   | call priority |   |   |   |

octet 1  
octet 2

The call priority field (bit 3 to 1 of octet 2) is coded in the same way as the call priority field (bit 3 to 1 of octet 5) in the Descriptive group or broadcast call reference information element as defined in 3GPP TS 24.008 [6].

### 3.2.2.57 Configuration Evolution Indication

This information element indicates whether subsequent assignment requests should be expected and the limitation for these subsequent assignments.

|                    |   |   |   |     |   |   |   |         |
|--------------------|---|---|---|-----|---|---|---|---------|
| 8                  | 7 | 6 | 5 | 4   | 3 | 2 | 1 |         |
| Element identifier |   |   |   |     |   |   |   | octet 1 |
| spare              |   |   |   | SMI |   |   |   | octet 2 |

SMI: Subsequent Modification Indication. This indicates the maximum number of TCH/F that could be requested in subsequent assignments.

The SMI field is coded as follows:

|     |   |
|-----|---|
| Bit | <b>4321</b>   |
|     | 0000 No Modification is allowed                               |
|     | 0001 Modification is allowed and maximum number of TCH/F is 1 |
|     | 0010 Modification is allowed and maximum number of TCH/F is 2 |
|     | 0011 Modification is allowed and maximum number of TCH/F is 3 |
|     | 0100 Modification is allowed and maximum number of TCH/F is 4 |

All other values are reserved.

### 3.2.2.58 Old BSS to New BSS information

This information element is defined as a general container for passing Field Elements transparently between BSSs via the MSC.

These Field Elements are passed in the "Old BSS to New BSS information elements" octets field. The error handling performed by the receiving entity for the "Old BSS to New BSS information elements" field is that specified in subclause 3.1.19.7.

|   |   |   |   |   |   |   |   |           |
|---|---|---|---|---|---|---|---|-----------|
| 8                                       | 7 | 6 | 5 | 4 | 3 | 2 | 1 |           |
| Element identifier                      |   |   |   |   |   |   |   | octet 1   |
| Length                                  |   |   |   |   |   |   |   | octet 2   |
| Old BSS to New BSS information elements |   |   |   |   |   |   |   | octet 3-n |

The length indicator (octet 2) is a binary number indicating the absolute length of the contents after the length indicator octet and may be set to zero.

The Old BSS to New BSS information elements field is made up of 0 or more Field Elements listed in the table shown below.

Field elements may occur in any order in the Old BSS to New BSS information elements field.

The construction of the Field Elements allows the receiver to ignore unknown Field Elements.

Due to backward compatibility issues Field Elements in the "Old BSS to New BSS information" may duplicate Information Elements in the HANDOVER REQUEST, when this occurs and the new BSS detects an inconsistency between this information then the information contained in the "Old BSS to New BSS information" shall take precedence as long as the coding is understood by the new BSS.

Reception of an erroneous "Old BSS to New BSS information" shall not cause a rejection of the HANDOVER REQUEST message; the "Old BSS to New BSS information" information element shall be discarded and the handover resource allocation procedure shall continue.

| FIELD ELEMENT                       | REFERENCE | LEN |
|-------------------------------------|-----------|-----|
| Extra information                   | 3.2.3.1   | 3   |
| Current Channel Type 2              | 3.2.3.2   | 4   |
| Target cell radio information       | 3.2.3.3   | 3   |
| GPRS Suspend information            | 3.2.3.4   | 19  |
| MultiRate configuration information | 3.2.3.5   | 3-8 |
| Dual Transfer Mode information      | 3.2.3.6   | 3   |
| Inter RAT Handover Info             | 3.2.3.7   | 3-n |
| cdma2000 Capability Information     | 3.2.3.8   | n   |

3.2.2.59 Void

3.2.2.60 LCS QoS

This element indicates the Quality of Service requirements for the location request.

It is coded as follows:

|                    |   |   |   |   |   |   |   |                                 |
|--------------------|---|---|---|---|---|---|---|---------------------------------|
| 8                  | 7 | 6 | 5 | 4 | 3 | 2 | 1 | octet 1<br>octet 2<br>octet 3-n |
| Element identifier |   |   |   |   |   |   |   |                                 |
| Length             |   |   |   |   |   |   |   |                                 |
| QoS                |   |   |   |   |   |   |   |                                 |

The coding of octet 2 is a binary number indicating the length of the remaining element.

The QoS octets 3 to n are coded in the same way as the equivalent octets in the LCS QoS element of 3GPP TS 49.031 [19a].

3.2.2.61 LSA Access Control Suppression

This information element is included if LSA access control function shall be suppressed in the BSS.

It is coded as follows:

|                    |   |   |   |   |   |   |    |                    |
|--------------------|---|---|---|---|---|---|----|--------------------|
| 8                  | 7 | 6 | 5 | 4 | 3 | 2 | 1  | octet 1<br>octet 2 |
| Element identifier |   |   |   |   |   |   | EM |                    |
| spare              |   |   |   |   |   |   |    |                    |

If the connection is an emergency call the MSC shall set the emergency field (bit 1 of octet 2) to 1. If the emergency field is set to 1, the BSS shall suppress exclusive access, LSA only access and preferential access functionality.

3.2.2.62 LCS Priority

The LCS Priority defines the priority of the location request.

It is coded as follows:

|                    |   |   |   |   |   |   |   |                                 |
|--------------------|---|---|---|---|---|---|---|---------------------------------|
| 8                  | 7 | 6 | 5 | 4 | 3 | 2 | 1 | octet 1<br>octet 2<br>octet 3-n |
| Element identifier |   |   |   |   |   |   |   |                                 |
| Length             |   |   |   |   |   |   |   |                                 |
| Priority           |   |   |   |   |   |   |   |                                 |

The coding of octet 2 is a binary number indicating the length of the remaining element.

The Priority octets 3 to n are coded in the same way as the equivalent octets in the LCS Priority element of 3GPP TS 49.031 [19a].

### 3.2.2.63 Location Type

The Location Type information element indicates the type of location request.

It is coded as follows:

|                    |   |   |   |   |   |   |   |           |
|--------------------|---|---|---|---|---|---|---|-----------|
| 8                  | 7 | 6 | 5 | 4 | 3 | 2 | 1 |           |
| Element identifier |   |   |   |   |   |   |   | octet 1   |
| Length             |   |   |   |   |   |   |   | octet 2   |
| Location Type      |   |   |   |   |   |   |   | octet 3-n |

The coding of octet 2 is a binary number indicating the length of the remaining element.

The Location Type octets 3 to n are coded in the same way as the equivalent octets in the Location Type element of 3GPP TS 49.031 [19a].

### 3.2.2.64 Location Estimate

This is a variable length information element providing an estimate of a geographic location of a target MS.

It is coded as follows:

|                    |   |   |   |   |   |   |   |           |
|--------------------|---|---|---|---|---|---|---|-----------|
| 8                  | 7 | 6 | 5 | 4 | 3 | 2 | 1 |           |
| Element identifier |   |   |   |   |   |   |   | octet 1   |
| Length             |   |   |   |   |   |   |   | octet 2   |
| Location estimate  |   |   |   |   |   |   |   | octet 3-n |

The length indicator is a binary indication of the number of octets following in the element.

The Location Estimate field is composed of 1 or more octets with an internal structure according to 3GPP TS 23.032 [3a].

### 3.2.2.65 Positioning Data

This element indicates the data on the positioning process for possible use in billing in location method evaluation.

It is coded as follows:

|                    |   |   |   |   |   |   |   |           |
|--------------------|---|---|---|---|---|---|---|-----------|
| 8                  | 7 | 6 | 5 | 4 | 3 | 2 | 1 |           |
| Element identifier |   |   |   |   |   |   |   | octet 1   |
| Length             |   |   |   |   |   |   |   | octet 2   |
| Positioning data   |   |   |   |   |   |   |   | octet 3-n |

The coding of octet 2 is a binary number indicating the length of the remaining element.

The Positioning Data octets 3 to n are coded in the same way as the equivalent octets in the Positioning Data element of 3GPP TS 49.031 [19a].

### 3.2.2.66 LCS Cause

This element indicates the data on the positioning process for possible use in billing in location method evaluation.

It is coded as follows:

|                    |   |   |   |   |   |   |   |           |
|--------------------|---|---|---|---|---|---|---|-----------|
| 8                  | 7 | 6 | 5 | 4 | 3 | 2 | 1 |           |
| Element identifier |   |   |   |   |   |   |   | octet 1   |
| Length             |   |   |   |   |   |   |   | octet 2   |
| LCS Cause          |   |   |   |   |   |   |   | octet 3-n |

The coding of octet 2 is a binary number indicating the length of the remaining element.



The LCS Cause octets 3 to n are coded in the same way as the equivalent octets in the LCS Cause element of 3GPP TS 49.031 [19a].

### 3.2.2.67 LCS Client Type

This element identifies the type of LCS Client.

It is coded as follows:

|                    |   |   |   |   |   |   |   |           |
|--------------------|---|---|---|---|---|---|---|-----------|
| 8                  | 7 | 6 | 5 | 4 | 3 | 2 | 1 |           |
| Element identifier |   |   |   |   |   |   |   | octet 1   |
| Length             |   |   |   |   |   |   |   | octet 2   |
| LCS Client Type    |   |   |   |   |   |   |   | octet 3-n |

The LCS Client Type octets 3 to n are coded in the same way as the equivalent octet in the LCS Client Type element of 3GPP TS 49.031 [19a].

### 3.2.2.68 APDU

This information element is defined as a general container for passing information transparently between BSSs or between BSS and SMLC via the MSC.

It is coded as follows:

|                    |   |   |   |   |   |   |   |           |
|--------------------|---|---|---|---|---|---|---|-----------|
| 8                  | 7 | 6 | 5 | 4 | 3 | 2 | 1 |           |
| Element identifier |   |   |   |   |   |   |   | octet 1   |
| Length             |   |   |   |   |   |   |   | octet 2-3 |
| APDU               |   |   |   |   |   |   |   | octet 4-n |

The length indicator is a binary indication of the number of octets following in the element.

The APDU octets 4 to n are coded in the same way as the equivalent octet in the APDU element of 3GPP TS 49.031 [19a].

### 3.2.2.69 Network Element Identity

This is a variable length information element identifying a network element, by association with either a designated cell site or a designated location area.

It is coded as follows:

|                          |   |   |   |   |   |   |   |           |
|--------------------------|---|---|---|---|---|---|---|-----------|
| 8                        | 7 | 6 | 5 | 4 | 3 | 2 | 1 |           |
| Element identifier       |   |   |   |   |   |   |   | octet 1   |
| Length                   |   |   |   |   |   |   |   | octet 2   |
| Network Element Identity |   |   |   |   |   |   |   | octet 3-n |

The coding of octet 2 is a binary number indicating the length of the remaining element.

The Network Element Identity octets 3 to n are coded in the same way as the equivalent octets in the Network Element Identity element of 3GPP TS 49.031 [19a].

### 3.2.2.70 GPS Assistance Data

This is a variable length information element indicating the requested GPS assistance data.

It is coded as follows:

|                     |   |   |   |   |   |   |   |           |
|---------------------|---|---|---|---|---|---|---|-----------|
| 8                   | 7 | 6 | 5 | 4 | 3 | 2 | 1 |           |
| Element identifier  |   |   |   |   |   |   |   | octet 1   |
| Length              |   |   |   |   |   |   |   | octet 2   |
| GPS Assistance Data |   |   |   |   |   |   |   | octet 3-n |

The coding of octet 2 is a binary number indicating the length of the remaining element.

The GPS Assistance Data octets 3 to n are coded in the same way as the equivalent octets in the Requested GPS Data element of 3GPP TS 49.031 [19a].

### 3.2.2.71 Deciphering Keys

This is a variable length information element indicating the requested GPS assistance data.

It is coded as follows:

|                    |   |   |   |   |   |   |   |           |
|--------------------|---|---|---|---|---|---|---|-----------|
| 8                  | 7 | 6 | 5 | 4 | 3 | 2 | 1 |           |
| Element identifier |   |   |   |   |   |   |   | octet 1   |
| Length             |   |   |   |   |   |   |   | octet 2   |
| Deciphering Keys   |   |   |   |   |   |   |   | octet 3-n |

The coding of octet 2 is a binary number indicating the length of the remaining element.

The Deciphering Key octets 3 to n are coded in the same way as the equivalent octets in the Deciphering Key element of 3GPP TS 49.031 [19a].

### 3.2.2.72 Return Error Request

This is a variable length information element indicating a request from the source for an error response if the message cannot be delivered to its final destination.

It is coded as follows:

|                    |   |   |   |   |   |   |   |           |
|--------------------|---|---|---|---|---|---|---|-----------|
| 8                  | 7 | 6 | 5 | 4 | 3 | 2 | 1 |           |
| Element identifier |   |   |   |   |   |   |   | octet 1   |
| Length             |   |   |   |   |   |   |   | octet 2   |
| Return Error Type  |   |   |   |   |   |   |   | octet 3-n |

The coding of octet 2 is a binary number indicating the length of the remaining element.

The Return Error Type octets from 3 to n are coded in the same way as the equivalent octets in the Return Error Request element of 3GPP TS 49.031 [19a].

### 3.2.2.73 Return Error Cause

This is a variable length information element indicating the reason for unsuccessful delivery of a message to its final destination.

It is coded as follows:

|                    |   |   |   |   |   |   |   |           |
|--------------------|---|---|---|---|---|---|---|-----------|
| 8                  | 7 | 6 | 5 | 4 | 3 | 2 | 1 |           |
| Element identifier |   |   |   |   |   |   |   | octet 1   |
| Length             |   |   |   |   |   |   |   | octet 2   |
| Cause Value        |   |   |   |   |   |   |   | octet 3-n |

The coding of octet 2 is a binary number indicating the length of the remaining element.

The Cause Value octets from 3 to n are coded in the same way as the equivalent octets in the Return Error Cause element of 3GPP TS 49.031 [19a].

### 3.2.2.74 Segmentation

This is a variable length information element containing segmentation and message information for a segmented APDU.

It is coded as follows:

|                                      |   |   |   |   |   |   |   |           |
|--------------------------------------|---|---|---|---|---|---|---|-----------|
| 8                                    | 7 | 6 | 5 | 4 | 3 | 2 | 1 |           |
| Element identifier                   |   |   |   |   |   |   |   | octet 1   |
| Length                               |   |   |   |   |   |   |   | octet 2   |
| Segmentation and Message Information |   |   |   |   |   |   |   | octet 3-n |

The coding of octet 2 is a binary number indicating the length of the remaining element.

The Segmentation and Message information octets from 3 to n are coded in the same way as the equivalent octets in the Segmentation element of 3GPP TS 49.031 [19a].

### 3.2.2.75 Service Handover

The Service Handover defines information to use for handover to UTRAN or cdma2000. It is coded as follows:

|                              |   |   |   |   |   |   |   |         |
|------------------------------|---|---|---|---|---|---|---|---------|
| 8                            | 7 | 6 | 5 | 4 | 3 | 2 | 1 |         |
| Element identifier           |   |   |   |   |   |   |   | octet 1 |
| Length                       |   |   |   |   |   |   |   | octet 2 |
| Service Handover information |   |   |   |   |   |   |   | octet 3 |

Octet 2 is a binary indication of the length of the remainder of the element in octets.

Service Handover information is coded as follows:

Bits 4 - 8: Spare.

Bits 1 - 3:

3 2 1

- 0 0 0 Handover to UTRAN or cdma2000 should be performed  
Handover to UTRAN or cdma2000 is preferred. The handover evaluation of the target cell for handovers shall take into account the preference for UTRAN or cdma2000.
- 0 0 1 Handover to UTRAN or cdma2000 should not be performed  
Handover to GSM is preferred. The handover evaluation of the target cell for handovers shall take into account the preference for GSM.
- 0 1 0 Handover to UTRAN or cdma2000 shall not be performed  
Handover to UTRAN or cdma2000 is not allowed.

All other values are interpreted as no information available for service based handover.

### 3.2.2.76 Source RNC to target RNC transparent information (UMTS)

This information element is defined as a general container for passing (e.g. UE Capability Information, Target Cell ID) RNC specific information transparently through the core network from BSS to RNC.

|  |   |   |   |   |   |   |   |           |
|--|---|---|---|---|---|---|---|-----------|
| 8  | 7 | 6 | 5 | 4 | 3 | 2 | 1 |           |
| Element identifier                             |   |   |   |   |   |   |   | octet 1   |
| Length   |   |   |   |   |   |   |   | octet 2   |
| Source RNC to target RNC information container |   |   |   |   |   |   |   | octet 3-n |

The Source RNC to Target RNC Information container structure and encoding is defined in relevant RANAP specification 3GPP TS 25.413 [31], excluding RANAP tag.

### 3.2.2.77 Source RNC to target RNC transparent information (cdma2000)

This information element is defined as a general container for passing (e.g. cdma2000 Capability Information, Target Cell ID) RNC specific information transparently through the core network from BSS to RNC.

|  |   |   |   |   |   |   |   |           |
|--|---|---|---|---|---|---|---|-----------|
| 8  | 7 | 6 | 5 | 4 | 3 | 2 | 1 |           |
| Element identifier                             |   |   |   |   |   |   |   | octet 1   |
| Length   |   |   |   |   |   |   |   | octet 2   |
| Source RNC to target RNC information container |   |   |   |   |   |   |   | octet 3-n |

The Source RNC to Target RNC Information container structure and encoding is defined in relevant RANAP specification 3GPP TS 25.413 [31], excluding RANAP tag.

## 3.2.3 Signalling Field Element Coding

The coding rules for signalling field elements are the same as the signalling element coding rules which are defined in subclause 3.2.2.

Signalling field elements shall always include a Field Length indicator. A Field Length indicator with a value of zero shall not be considered as an error.

| Field Element Identifier Coding | Field Element name                  | Reference |
|---------------------------------|-------------------------------------|-----------|
| 0000 0001                       | Extra information                   | 3.2.3.1   |
| 0000 0010                       | Current Channel Type 2              | 3.2.2.2   |
| 0000 0011                       | Target cell radio information       | 3.2.3.3   |
| 0000 0100                       | GPRS Suspend information            | 3.2.3.4   |
| 0000 0101                       | MultiRate configuration information | 3.2.3.5   |
| 0000 0110                       | Dual Transfer Mode information      | 3.2.3.6   |
| 0000 0111                       | Inter RAT Handover Info             | 3.2.3.7   |
| 0000 1000                       | cdma2000 Capability Information     | 3.2.3.8   |

All other values are for future use.

### 3.2.3.1 Extra information

This field element provides a general flag mechanism that allows the old BSS to indicate to the new BSS flag information.

It is coded as follows:

|                          |   |   |   |   |   |   |   |         |
|--------------------------|---|---|---|---|---|---|---|---------|
| 8                        | 7 | 6 | 5 | 4 | 3 | 2 | 1 |         |
| Field Element identifier |   |   |   |   |   |   |   | octet 1 |
| Length                   |   |   |   |   |   |   |   | octet 2 |
|                          |   |   |   |   |   |   |   | octet 3 |

Octet 2 is a binary indication of the length of the rest of the field element.

Octet 3 is coded as follows:

|       |   |   |   |   |   |     |      |         |
|-------|---|---|---|---|---|-----|------|---------|
| 8     | 7 | 6 | 5 | 4 | 3 | 2   | 1    |         |
| spare |   |   |   |   |   | lcs | prec | octet 3 |

Bit 8 to 2 are flags that indicate no information.

prec = Pre-emption Recommendation

- 0 The old BSS recommends that this allocation request should not cause a pre-emption an existing connection.

- 1 The old BSS recommends that this allocation request is allowed to preempt an existing connection based on the information supplied in the Priority information element, if available.

In the case the "prec" bit is not present or the Extra Information field element is not present then the new BSS should run pre-emption as specified by the Priority information element, if available.

In the case where the Priority information element is not present in the request then the "prec" element, if present, shall be ignored.

lcs = Location Services (LCS) information

- 0 No ongoing LCS procedure.
- 1 An ongoing LCS procedure was interrupted by handover. The new BSS may notify the SMLC when the handover is completed.

### 3.2.3.2 Current Channel type 2

This Field Element contains a description of the channel allocated to the MS.

It is coded as follows:

|                    |   |   |   |   |   |   |   |         |
|--------------------|---|---|---|---|---|---|---|---------|
| 8                  | 7 | 6 | 5 | 4 | 3 | 2 | 1 |         |
| Element identifier |   |   |   |   |   |   |   | octet 1 |
| Length             |   |   |   |   |   |   |   | octet 2 |
| Channel mode       |   |   |   |   |   |   |   | octet 3 |
| Channel field      |   |   |   |   |   |   |   | octet 4 |

The channel mode field is coded as follows:

- Bit **4321**
- 0000 signalling only
- 0001 speech (full rate or half rate)
- 0110 data, 14.5 kbit/s radio interface rate
- 0011 data, 12.0 kbit/s radio interface rate
- 0100 data, 6.0 kbit/s radio interface rate
- 0101 data, 3.6 kbit/s radio interface rate
- 1111 is reserved

All other values indicate that no information is provided.

Bits 8 to 5 are spare.

The channel field is coded as follows:

- Bit **4321**
- 0001 SDCCH
- 1000 1 Full rate TCH
- 1001 1 Half rate TCH
- 1010 2 Full Rate TCHs
- 1011 3 Full Rate TCHs
- 1100 4 Full Rate TCHs
- 1101 5 Full Rate TCHs
- 1110 6 Full Rate TCHs
- 1111 7 Full Rate TCHs
- 0100 8 Full Rate TCHs
- 0000 is reserved

All other values indicate that no information is provided.

Bits 8 to 5 are spare.

### 3.2.3.3 Target cell radio information

It is coded as follows:

|                    |   |   |   |   |   |   |   |
|--------------------|---|---|---|---|---|---|---|
| 8                  | 7 | 6 | 5 | 4 | 3 | 2 | 1 |
| Element identifier |   |   |   |   |   |   |   |
| Length             |   |   |   |   |   |   |   |
|                    |   |   |   |   |   |   |   |

octet 1  
octet 2  
octet 3

Octet 2 is a binary indication of the length of the rest of the element.

Octet 3 is coded as follows:

|   |   |   |   |             |   |   |   |
|---|---|---|---|-------------|---|---|---|
| 8 | 7 | 6 | 5 | 4           | 3 | 2 | 1 |
|   |   |   |   | RXLEV-NCELL |   |   |   |

octet 3

Bit 8 to 6 is spare, set to 0

Bit 5 to 1 is the RXLEV-NCELL field.

The RXLEV-NCELL field is coded as the binary representation of a value N. N corresponds according to the mapping defined in TS. 3GPP TS 45.008 to the received signal strength on the target cell.

### 3.2.3.4 GPRS Suspend Information

This Field Element contains the contents of the Gb interface SUSPEND ACK PDU.

It is coded as follows:

|                          |   |   |   |   |   |   |   |
|--------------------------|---|---|---|---|---|---|---|
| 8                        | 7 | 6 | 5 | 4 | 3 | 2 | 1 |
| Element identifier       |   |   |   |   |   |   |   |
| Length                   |   |   |   |   |   |   |   |
| Gb interface TLLI IEI    |   |   |   |   |   |   |   |
| Length of TLLI           |   |   |   |   |   |   |   |
| TLLI                     |   |   |   |   |   |   |   |
| Gb interface RAI IEI     |   |   |   |   |   |   |   |
| Length of RAI            |   |   |   |   |   |   |   |
| RAI                      |   |   |   |   |   |   |   |
| Gb interface SRN IEI     |   |   |   |   |   |   |   |
| Length of SRN            |   |   |   |   |   |   |   |
| Suspend reference number |   |   |   |   |   |   |   |

octet 1  
octet 2  
octet 3  
octet 4  
oct 5 - 5+m  
octet 6+m  
octet 7+m  
oct 7+m - n  
octet n+1  
octet n+2  
oct n+3 -p

The coding of the fields are not relevant to 3GPP TS 48.008 [6].

### 3.2.3.5 MultiRate configuration Information

This Field Element contains a description of the multi-rate speech codec configuration currently used.

It is coded as follows:

|   |   |   |   |   |   |   |   |
|---|---|---|---|---|---|---|---|
| 8   | 7 | 6 | 5 | 4 | 3 | 2 | 1 |
| Element identifier  |   |   |   |   |   |   |   |
| Length  |   |   |   |   |   |   |   |
| Rest of element coded as in 3GPP TS 44.018 [32],<br>not including 3GPP TS 44.018 [32] element identifier<br>or 3GPP TS 44.018 [32] octet length value |   |   |   |   |   |   |   |

octet 1  
octet 2  
octet 3-n

### 3.2.3.6 Dual Transfer Mode information

This Field Element contains information about a mobile in dual transfer mode. This information may be used for the target BSS to allocate the resources for the RR connection (e.g. TCH/H, TCH in an EGPRS transceiver).

It is coded as follows:

|                    |   |   |   |   |              |            |            |         |
|--------------------|---|---|---|---|--------------|------------|------------|---------|
| 8                  | 7 | 6 | 5 | 4 | 3            | 2          | 1          |         |
| Element identifier |   |   |   |   |              |            |            | octet 1 |
| Length             |   |   |   |   |              |            |            | octet 2 |
| Spare              |   |   |   |   | EGPRS<br>ind | STO<br>ind | DTM<br>ind | Octet 3 |

Octet Bit 1 is the dual transfer mode indicator. It indicates whether the MS is in dedicated mode or in dual transfer mode. It is coded as follows:

- Bit 1**
- 0 The MS is in dedicated mode in the old cell
  - 1 The MS is in dual transfer mode in the old cell

Bit 2 is the single timeslot operation indicator. It indicates whether the MS has a TCH/H and a PDCH/H; see 3GPP TS 45.002. It is coded as follows:

- Bit 2**
- 0 The MS is in multislot operation in the old cell
  - 1 The MS is in single timeslot operation in the old cell

Bit 3 is the EGPRS indicator. It is coded as follows:

- Bit 3**
- 0 The MS has no TBF using E-GPRS in the old cell
  - 1 The MS has a TBF using E-GPRS in the old cell

Bits 8 to 4 of octet 3 are spare.

### 3.2.3.7 Inter RAT Handover Info

The Inter RAT Handover Info information element is coded as follows:

|                          |   |   |   |   |   |   |   |           |
|--------------------------|---|---|---|---|---|---|---|-----------|
| 8                        | 7 | 6 | 5 | 4 | 3 | 2 | 1 |           |
| Field Element identifier |   |   |   |   |   |   |   | octet 1   |
| Length                   |   |   |   |   |   |   |   | octet 2   |
| Inter RAT Handover Info  |   |   |   |   |   |   |   | octet 3-n |

Octets 3-n are encoded as Inter RAT Handover Info as defined in TS 3GPP TS 25.331.

### 3.2.3.8 cdma2000 Capability Information

The cdma2000 Capability Information element is coded as follows:

|                                 |   |   |   |   |   |   |   |           |
|---------------------------------|---|---|---|---|---|---|---|-----------|
| 8                               | 7 | 6 | 5 | 4 | 3 | 2 | 1 |           |
| Field Element identifier        |   |   |   |   |   |   |   | octet 1   |
| Length                          |   |   |   |   |   |   |   | octet 2   |
| cdma2000 capability information |   |   |   |   |   |   |   | octet 3-n |

Octets 3 - n are encoded as octets 3-n of the cdma2000 Classmark Change message defined in 3GPP TS 44.018 [32].

### 3.2.4 List of Timers in the BSSMAP Procedures

| Timer | Title  | Time |
|-------|--|------|
| T1    | Time to receipt of BLOCKING ACKNOWLEDGE.at the BSS                               | O&M  |
| T2    | Reset guard period at the MSC  | O&M  |
| T4    | Time to receipt of RESET ACKNOWLEDGE at the BSS                                  | O&M  |
| T5    | Overload timer in the MSC, see 3.1.12.1  | O&M  |
| T6    | Overload timer in the MSC, see 3.1.12.1  | O&M  |
| T7    | Handover required periodicity  | O&M  |
| T8    | Time to receipt of successful handover information                               | O&M  |
| T10   | Time to return of ASSIGNMENT COMPLETE<br>or<br>ASSIGNMENT FAILURE from MS (note) | O&M  |
| T11   | Maximum allowed queuing time for assignment                                      | O&M  |
| T12   | Time to receipt of RESET CIRCUIT ACKNOWLEDGE at the MSC                          | O&M  |
| T13   | Reset guard period at the BSS  | O&M  |
| T16   | Time to receipt of RESET ACKNOWLEDGE at the MSC                                  | O&M  |
| T17   | Overload timer in the BSS, see 3.1.12.1  | O&M  |
| T18   | Overload timer in the BSS, see 3.1.12.1  | O&M  |
| T19   | Time to receipt of RESET CIRCUIT ACKNOWLEDGE at the BSS                          | O&M  |
| T20   | Time to receipt of CIRCUIT GROUP BLOCKING ACKNOWLEDGE at the BSS..               | O&M  |
| T21   | Time to receipt of BLOCKING ACKNOWLEDGE at the MSC                               | O&M  |
| T22   | Time to receipt of CIRCUIT GROUP BLOCKING ACKNOWLEDGE at the MSC                 | O&M  |
| Tqho  | Maximum allowed queuing time for handover  | O&M  |

NOTE: T10 is not the same as T3107 as defined in 3GPP TS 24.008 [6]

## 3.3 SDL Representation Of The Procedures At The BSS

The SDL diagrams may be inserted at a later stage after updating and carefully checking of consistency with the main text.

---

## 4 Broadcast Information Control Channel

Information that is transferred in the Broadcast Control Channel is stored locally at the BSS. The scheduling of this information on the BCCH is controlled autonomously by the BSS.

The set of information that is transmitted in the BCCH is derived locally or downloaded to the BSS via the BSS Operation and Maintenance Application Part.

---

## 5 Vocabulary

This clause contains definition of terms:

### **BSS**

Base Station System. This is the equipment which is accessed through the interface defined in the 08-series of Technical Specifications. It contains the functionality described in 3GPP TS 48.002 [16], and supports one or more cells. See 3GPP TS 41.004 [1].

### **BSSAP**

The Base Station System Application Part, this is the subsystem that contains the process dealing with radio resource control and management known as the Base Station System Management Application Part (BSSMAP) and transparent transfer of call control and mobility management information known as the Direct Transfer Application Part (DTAP). The BSSAPs at the BSS and the MSC are connected by means of SCCP connections.



## **DTAP**

The DTAP, Direct Transfer Application Part is a process which allows the direct transfer of messages between individual MSs and the MSC with no interpretation of layer 3 information at the BSS.

## **BSSMAP**

Base Station System Management Application Part. This is the process within the BSS that controls radio resources in response to instructions from the MSC.

## **INTERNAL HANDOVER**

An internal handover is a handover which takes place between channels on a cell or cells controlled by a single BSS. This handover operates without reference to the MSC (although the MSC will be informed on completion). Handovers of this type in one cell are called internal intra cell handovers and between cells are called internal inter cell handovers.

Handovers between channels on the same cell or between cells on the same BSS which are controlled by the MSC are external handovers and use identical procedures to those for inter-BSS handovers.

## **INTERSYSTEM HANDOVER**

An intersystem handover is a handover which takes place between different radio access systems (e.g. GSM BSS and UTRAN or GSM BSS and cdma2000 RAN)..

## **DIRECTED RETRY**

Directed Retry is the process of assigning a Mobile Station to a TCH in a cell other than the serving cell, e.g. in situations of congestion. It is triggered by the assignment procedure and employs internal or external handover procedures.

## **VGCS/VBS**

**VGCS/VBS call controlling SCCP connection:** The VGCS/VBS call controlling SCCP connection is an SCCP connection which supports the signalling for call SETUP of a VGCS/VBS call. One of these connections is needed to support each instance of a VGCS/VBS call within a BSS.

**VGCS/VBS resource controlling SCCP connection:** The VGCS/VBS resource controlling SCCP connection is an SCCP connection which supports the allocation of resources for a VGCS/VBS call. One or more of these connections is needed to support each instance of a VGCS/VBS call. The exact number of these SCCP connections is equal to the number of cells to which the VGCS/VBS call is to be supported.

## 6 List of diagrams

| Figure       | Title  |
|--------------|--|
| 1            | Signalling protocol reference model                              |
| 2            | Assignment   |
| 3            | Handover execution   |
| 4            | Handover required indication                                     |
| 5            | Handover resource allocation                                     |
| 6            | Release  |
| 7            | Release due to reason at the BSS                                 |
| 8 (not used) |  |
| 9            | Classmark updating   |
| 10           | Blocking of terrestrial circuits                                 |
| 11           | Reset  |
| 12           | Resource indication  |
| 13           | Handover candidate enquiry                                       |
| 14           | Flow control   |
| 15           | Paging   |
| 16           | Overview of handover procedure between two BSS's on the same MSC |
| 17           | Cipher mode control  |
| 18           | SAPI "n" rejection   |
| 19           | Load indication  |
| 20           | SUCCESSFUL UPLINK ALLOCATION                                     |
| 21           | UNSUCCESSFUL UPLINK ALLOCATION                                   |
| 22           | UPLINK RELEASE INDICATION  |
| 23           | UPLINK SEIZE COMMAND   |
| 24           | UPLINK RELEASE COMMAND   |
| 25           | Blocking of terrestrial circuits, MSC initiated                  |
| 26           | Circuit re-selection   |

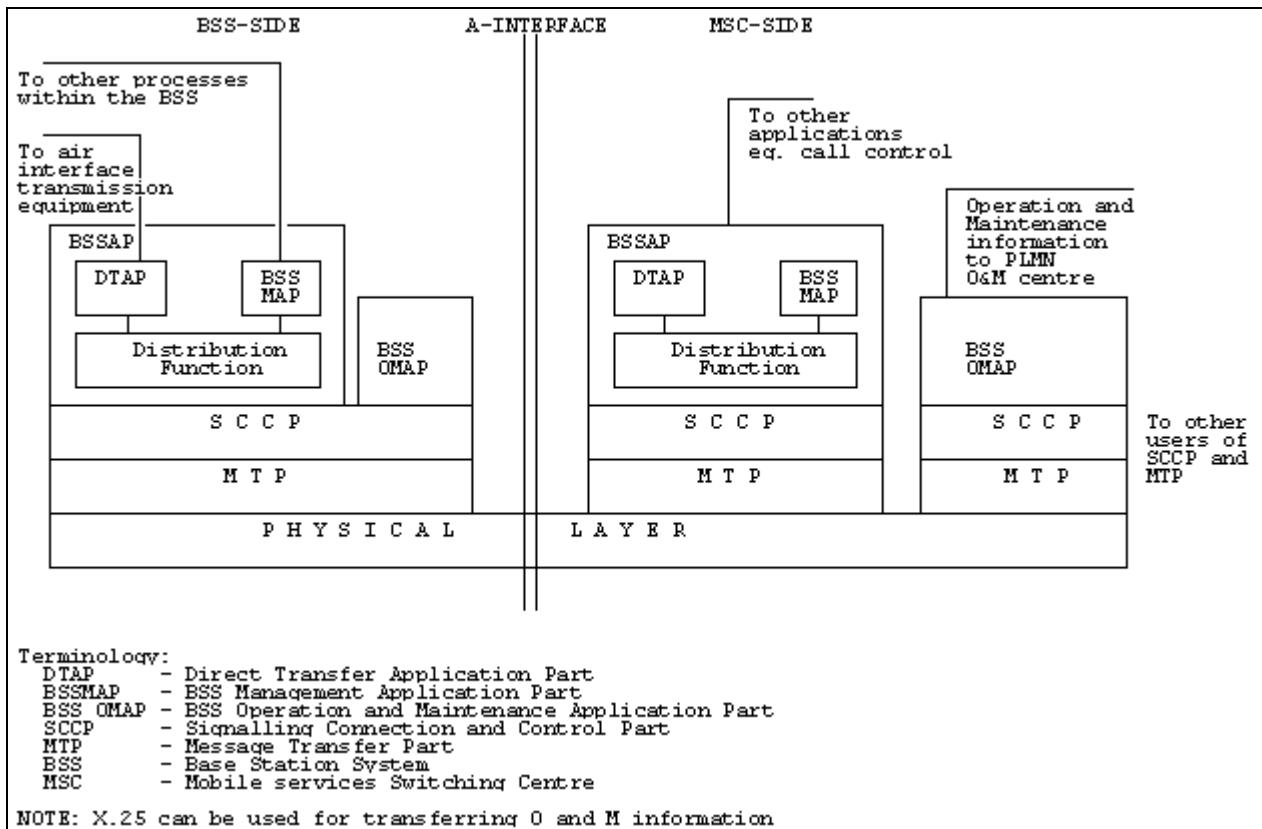

Figure 1: SIGNALLING PROTOCOL REFERENCE MODEL

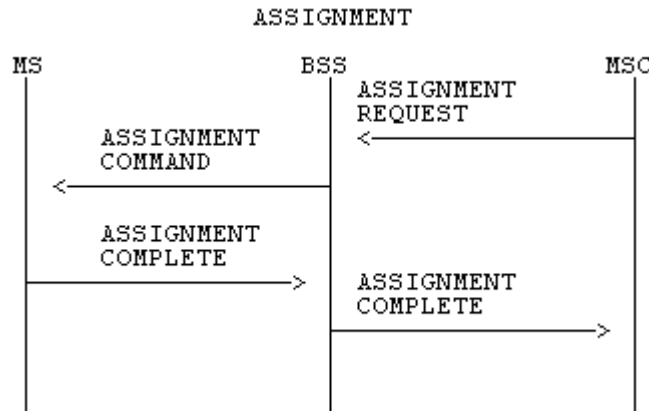

Figure 2

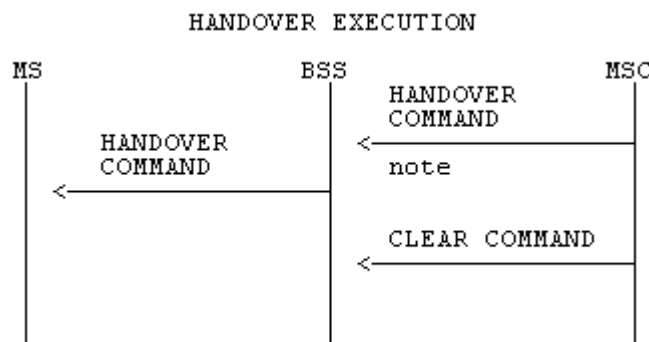

Figure 3

NOTE: A timer T8 is started to protect the overall procedure

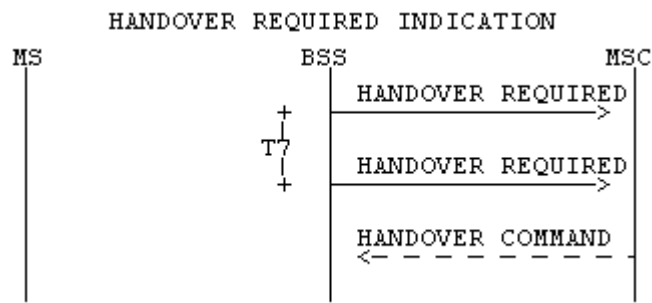

Figure 4

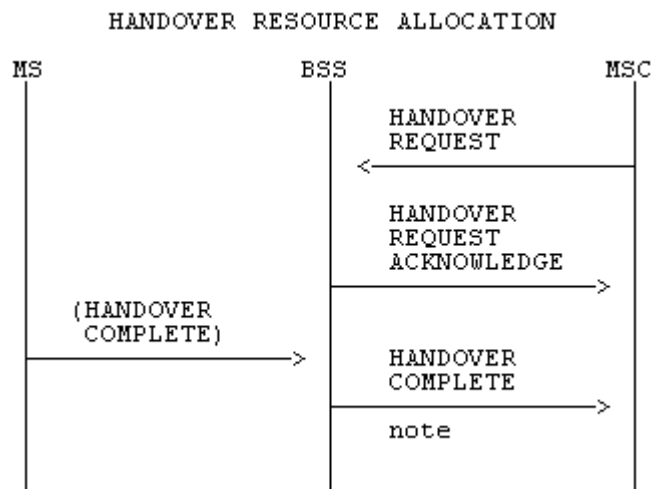

Figure 5

NOTE: The instant of generation of the Handover Complete is described in the text of 3GPP TS 48.008

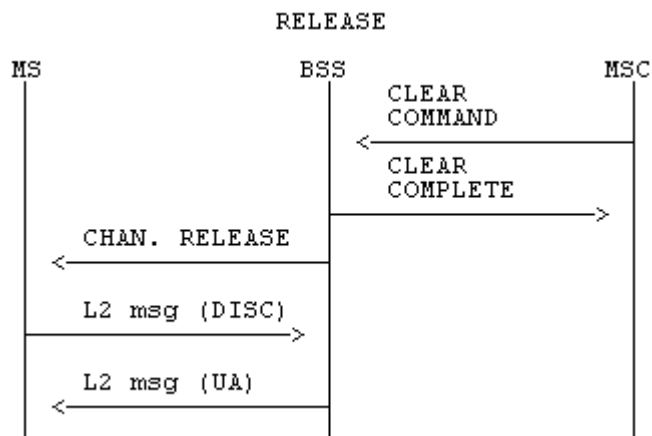

Figure 6

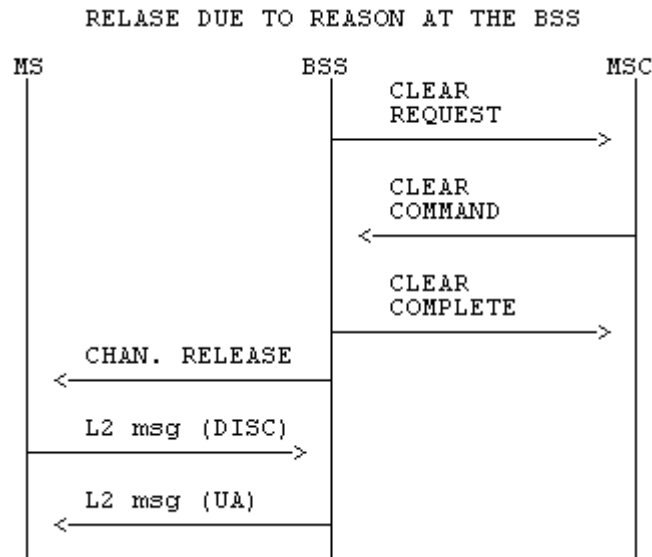

Figure 7

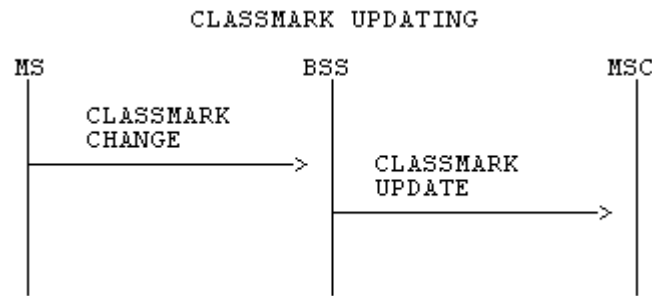

Figure 9

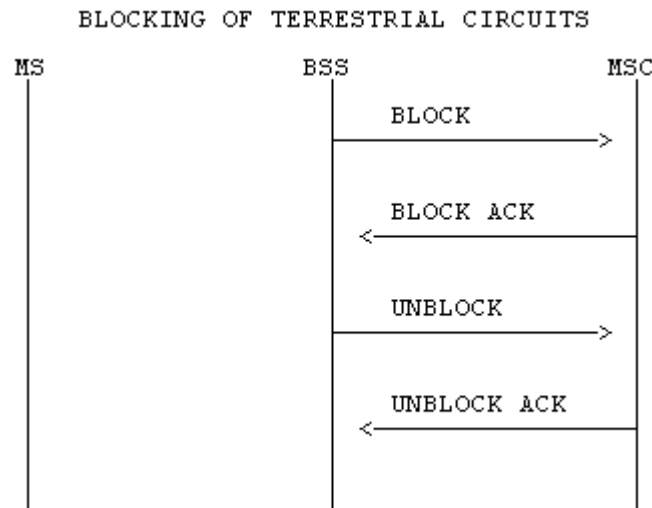

Figure 10

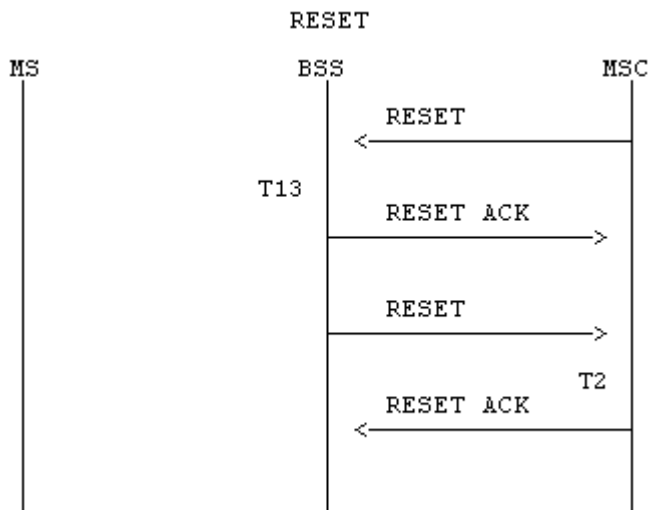

Figure 11

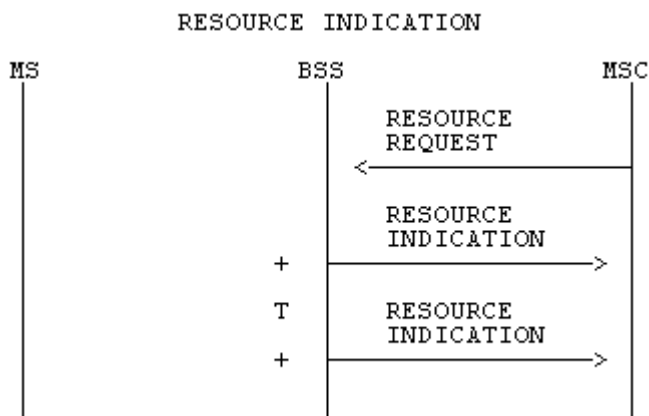

Figure 12

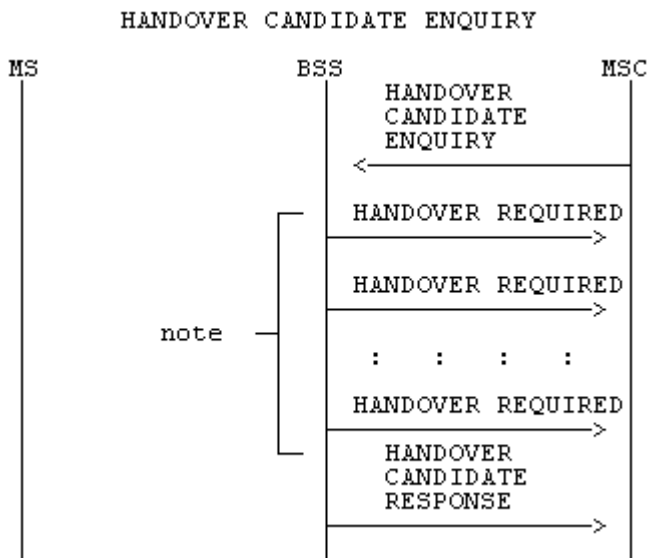

Figure 13

NOTE: Receipt of the Handover Candidate Enquiry Message causes the generation of a Handover Required message for each of candidate MS. These are sent as connection oriented messages. When all Handover Required messages have been generated a global Handover Candidate Response message is returned.

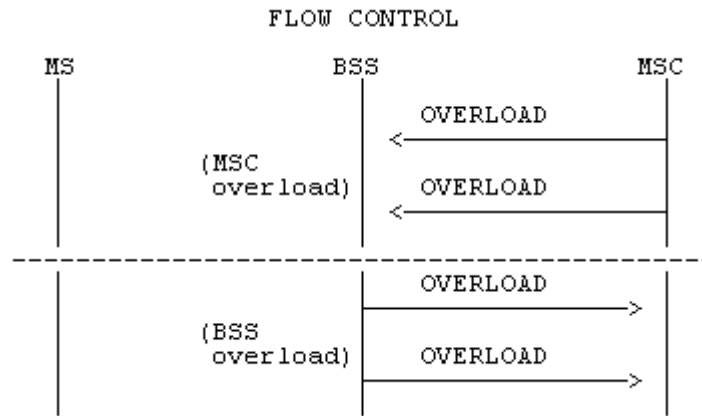

Figure 14

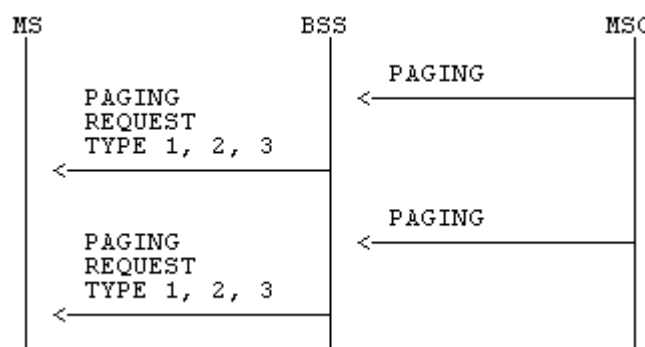

Figure 15

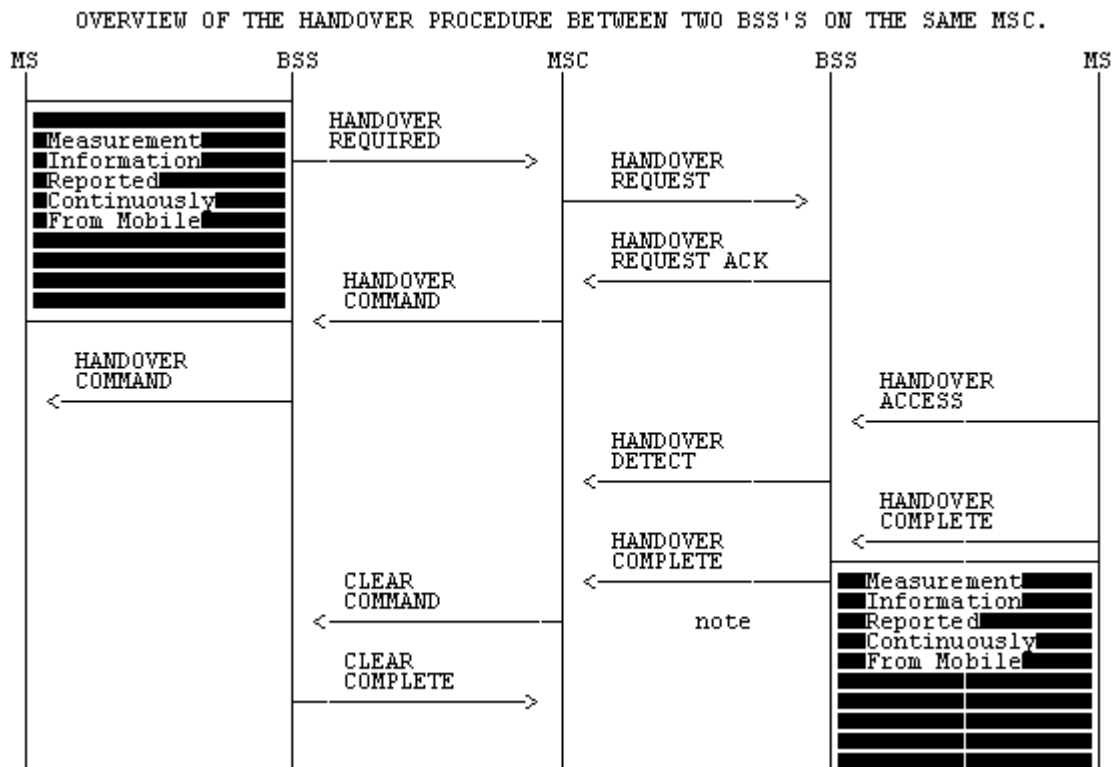

Figure 16

NOTE: The Handover Complete message can be sent as soon as the BSS is certain that the MS has successfully been captured.

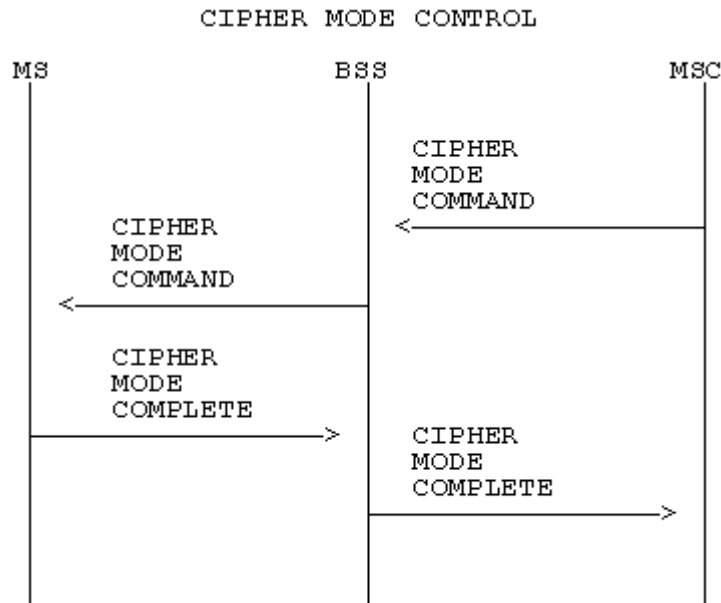

Figure 17

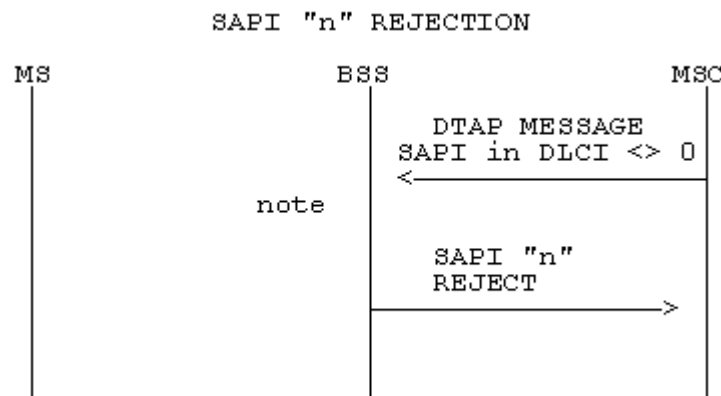

Figure 18

NOTE: The BSS or MS is not equipped for the SAPI request.

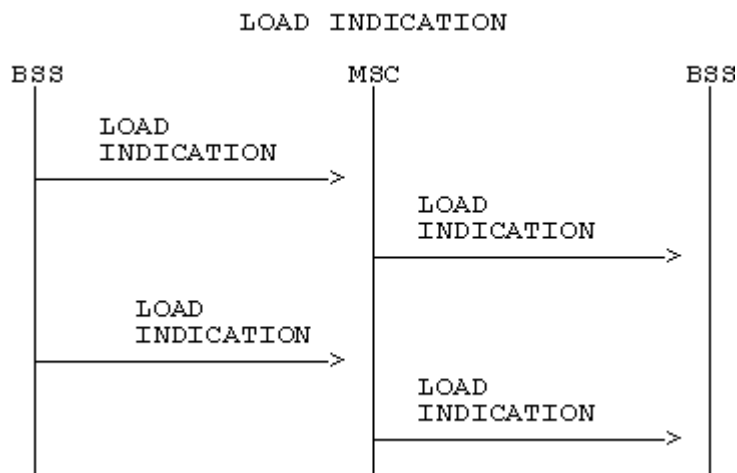

Figure 19



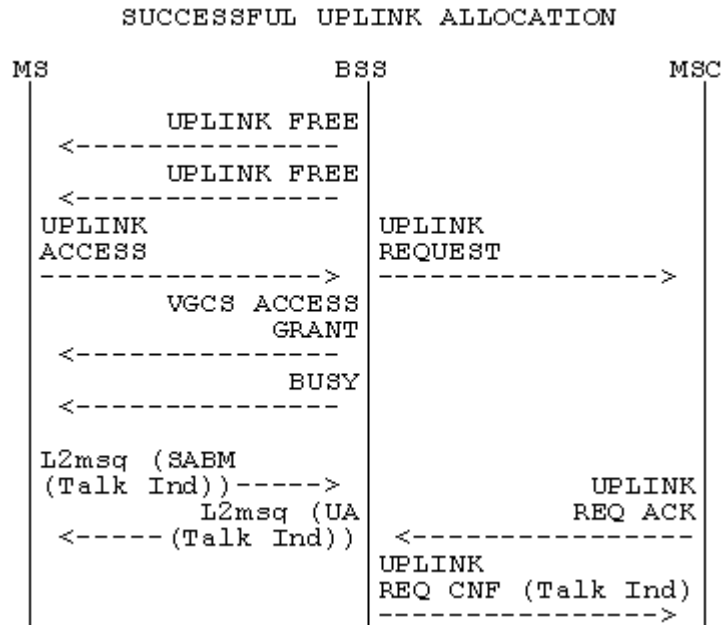

Figure 20

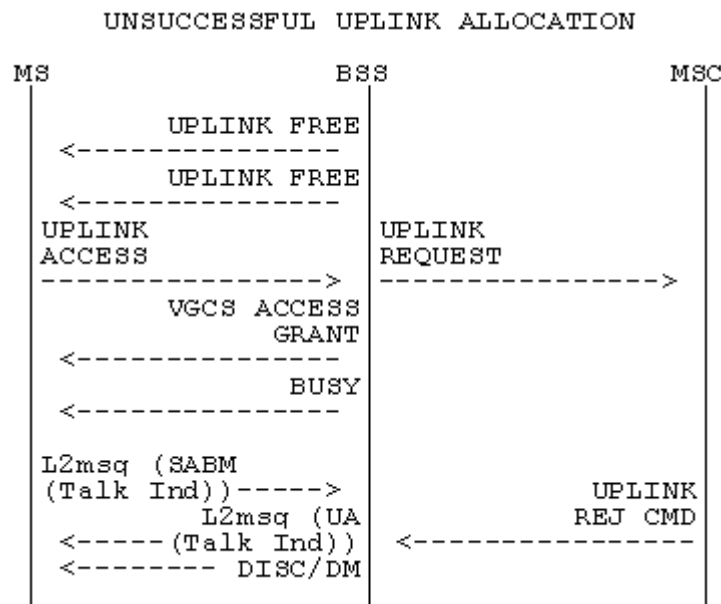

Figure 21

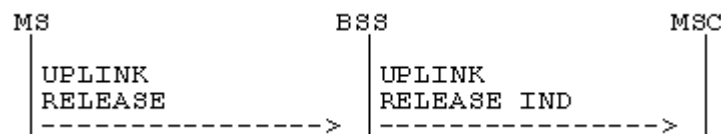

Figure 22

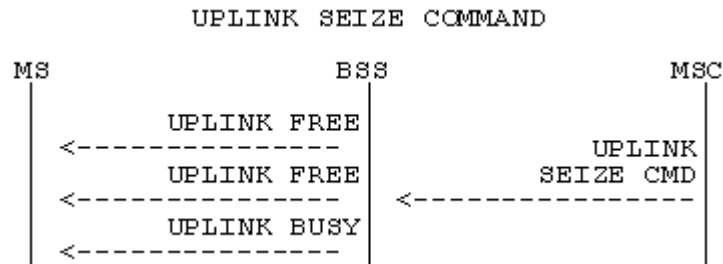

Figure 23

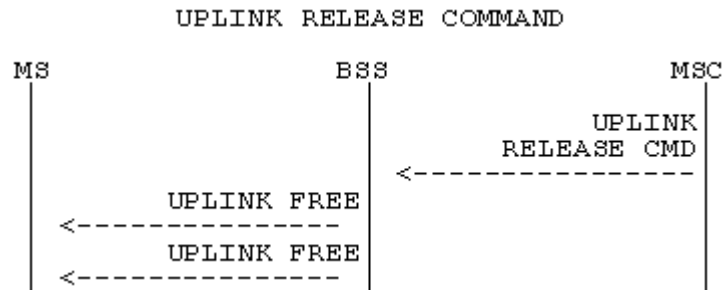

Figure 24

BLOCKING OF TERRESTRIAL CIRCUITS, MSC INITIATED

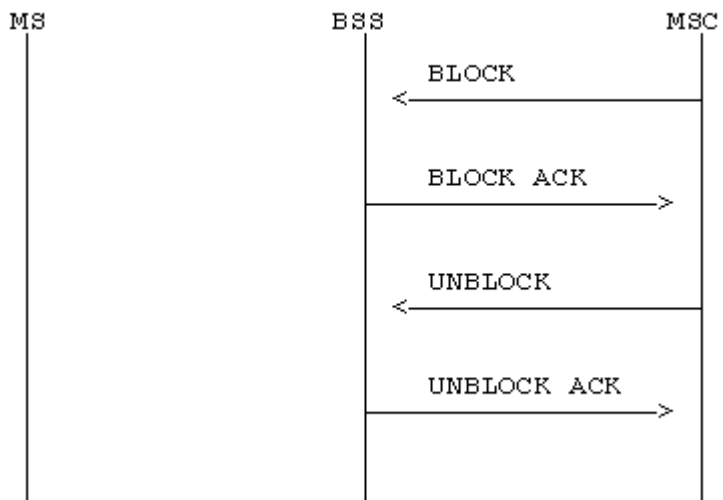

Figure 25

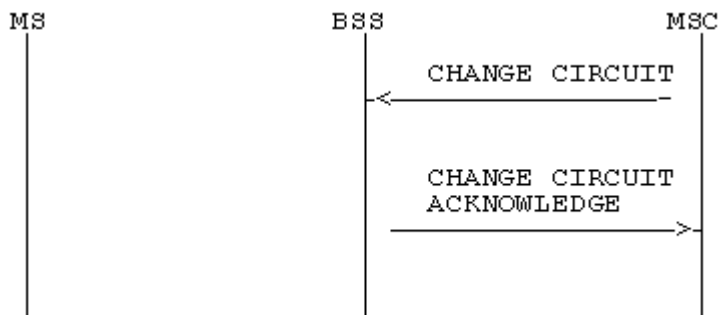

Figure 26

## Annex A (informative): Change control history

| TSG # | TSG Doc.  | CR  | Rev | Subject/Comment  | New           |
|-------|-----------|-----|-----|--|---------------|
|       |           |     |     | Conversion to 3GPP layout and number. Based upon 08.08 v9.0.0.   | 48.008 v4.0.0 |
| GP-01 | GP-000423 | 006 | 2   | DTM: clarification of the use of the COMMON ID message   | 4.1.0         |
| GP-01 | GP-000346 | 009 | 1   | Source Identification  | 4.1.0         |
| GP-01 | GP-000176 | 008 |     | Correction of Signalling Field Element Coding  | 4.1.0         |
| GP-01 | GP-000383 | 007 | 1   | 32 kbit/s UDI/RDI multimedia in GSM  | 4.1.0         |
| GP-01 | GP-000149 | 005 |     | DTM: deletion of reference to PDSS2  | 4.1.0         |
| GP-01 | GP-000141 | 004 |     | DTM: correction to DTM information in Old BSS to new BSS Information IE  | 4.1.0         |
| GP-01 | GP-000012 | 003 |     | Geographic Shape restriction in LCS  | 4.1.0         |
| GP-01 | GP-000033 | 002 |     | CLEAR REQUEST use precision with VGCS/VBS call   | 4.1.0         |
| GP-01 | GP-000477 | 013 |     | Old to New BSS container   | 4.1.0         |
| GP-01 | GP-000034 | 001 |     | VBS/VGCS assignment request message can be piggy-backed in a SCCP Connection Request message                                 | 4.1.0         |
|       |           |     |     | Oct 2000: Correction to references.  | 4.1.1         |
| GP-02 | GP-000837 | 014 | 1   | Notification response procedure precision  | 4.2.0         |
| GP-02 | GP-000619 | 015 |     | DTM: Addition of Common Id procedure   | 4.2.0         |
| GP-03 | GP-010318 | 016 | 1   | Clarification of asymmetry indication  | 4.3.0         |
| GP-03 | GP-010408 | 017 | 2   | Usage of Handover Performed message over MAP/E   | 4.3.0         |
| GP-03 | GP-010068 | 018 |     | Circuit pools for ECSD   | 4.3.0         |
| GP-04 | GP-010514 | 020 |     | Indication of successful Directed Retry in Assignment Complete (Rel 4).<br>NOTE: This cr number has been corrected from 009. | 4.4.0         |
| GP-04 | GP-010823 | 023 |     | Correction of coding of Signalling Field Element<br>NOTE: This cr number has been corrected from 012.                        | 4.4.0         |
| GP-04 | GP-010965 | 024 | 2   | Release 4 3GPP TS 48.008 Updates to support GERAN LCS Release 4<br>NOTE: This cr number has been corrected from 013R2.       | 4.4.0         |
| GP-06 | GP-011724 | 019 | 2   | Kc over MAP/E interface to 3G_MSC-B (Rel-4)  | 4.5.0         |
| GP-07 | GP-012831 | 035 | 3   | Transparent RRC containers in 2G-3G Handover Signalling( Rel 4)  | 4.6.0         |
| GP-08 | GP-020072 | 037 | 1   | Alignment of speech codecs references in GERAN specifications  | 4.7.0         |
| GP-08 | GP-020485 | 040 | 2   | Clarifications to service based handover to other RAT's  | 4.7.0         |
| GP-10 | GP-021450 | 048 |     | Length of Location Estimate IE in PERFORM LOCATION RESPONSE message  | 4.8.0         |
| GP-10 | GP-021745 | 054 |     | Multirate Configuration IE, Correction of Reference  | 4.8.0         |
| GP-10 | GP-021899 | 050 | 1   | Clarification of the Cell Identifier (Serving) IE in HANDOVER REQUEST message in UMTS to GSM handover                        | 4.8.0         |
| GP-10 | GP-021902 | 052 | 1   | Clarification of the RNC-ID coding in Cell Identifier and Cell Identifier List IEs   | 4.8.0         |

---

## History

| <b>Document history</b> |                |             |
|-------------------------|----------------|-------------|
| V4.4.0                  | April 2001     | Publication |
| V4.5.0                  | September 2001 | Publication |
| V4.6.0                  | January 2002   | Publication |
| V4.7.0                  | February 2002  | Publication |
| V4.8.0                  | July 2002      | Publication |