

ETSI TS 148 058 V6.1.0 (2005-01)

Technical Specification

**Digital cellular telecommunications system (Phase 2+);
Base Station Controller - Base Transceiver Station (BCS-BTS)
Interface Layer 3 Specification
(3GPP TS 48.058 version 6.1.0 Release 6)**



Reference

RTS/TSGG-0248058v610

Keywords

GSM

ETSI

650 Route des Lucioles
F-06921 Sophia Antipolis Cedex - FRANCE

Tel.: +33 4 92 94 42 00 Fax: +33 4 93 65 47 16

Siret N° 348 623 562 00017 - NAF 742 C
Association à but non lucratif enregistrée à la
Sous-Préfecture de Grasse (06) N° 7803/88

Important notice

Individual copies of the present document can be downloaded from:

<http://www.etsi.org>

The present document may be made available in more than one electronic version or in print. In any case of existing or perceived difference in contents between such versions, the reference version is the Portable Document Format (PDF). In case of dispute, the reference shall be the printing on ETSI printers of the PDF version kept on a specific network drive within ETSI Secretariat.

Users of the present document should be aware that the document may be subject to revision or change of status. Information on the current status of this and other ETSI documents is available at

<http://portal.etsi.org/tb/status/status.asp>

If you find errors in the present document, please send your comment to one of the following services:

http://portal.etsi.org/chaicor/ETSI_support.asp

Copyright Notification

No part may be reproduced except as authorized by written permission.
The copyright and the foregoing restriction extend to reproduction in all media.

© European Telecommunications Standards Institute 2005.
All rights reserved.

DECTTM, **PLUGTESTS**TM and **UMTS**TM are Trade Marks of ETSI registered for the benefit of its Members.
TIPHONTM and the **TIPHON logo** are Trade Marks currently being registered by ETSI for the benefit of its Members.
3GPPTM is a Trade Mark of ETSI registered for the benefit of its Members and of the 3GPP Organizational Partners.

Intellectual Property Rights

IPRs essential or potentially essential to the present document may have been declared to ETSI. The information pertaining to these essential IPRs, if any, is publicly available for **ETSI members and non-members**, and can be found in ETSI SR 000 314: *"Intellectual Property Rights (IPRs); Essential, or potentially Essential, IPRs notified to ETSI in respect of ETSI standards"*, which is available from the ETSI Secretariat. Latest updates are available on the ETSI Web server (<http://webapp.etsi.org/IPR/home.asp>).

Pursuant to the ETSI IPR Policy, no investigation, including IPR searches, has been carried out by ETSI. No guarantee can be given as to the existence of other IPRs not referenced in ETSI SR 000 314 (or the updates on the ETSI Web server) which are, or may be, or may become, essential to the present document.

Foreword

This Technical Specification (TS) has been produced by ETSI 3rd Generation Partnership Project (3GPP).

The present document may refer to technical specifications or reports using their 3GPP identities, UMTS identities or GSM identities. These should be interpreted as being references to the corresponding ETSI deliverables.

The cross reference between GSM, UMTS, 3GPP and ETSI identities can be found under <http://webapp.etsi.org/key/queryform.asp>.

Contents

Intellectual Property Rights	2
Foreword.....	2
Foreword.....	7
1 Scope	8
1.1 References	8
1.2 Abbreviations	9
2 Protocol model	9
3 Radio Link Layer Management Procedures	10
3.1 Link establishment indication.....	10
3.2 Link establishment request	11
3.3 Link release indication	11
3.4 Link release request.....	11
3.5 Transmission of a transparent L3-Message in acknowledged mode	12
3.6 Reception of a transparent L3-Message in acknowledged mode.....	12
3.7 Transmission of a transparent L3-Message in unacknowledged mode	12
3.8 Reception of a transparent L3-Message in unacknowledged mode.....	12
3.9 Link error indication.....	13
Dedicated channel management procedures	13
4.1 Channel activation	13
4.1.1 Signalling Procedure.....	13
4.1.2 Activation for Intra-Cell Channel Change	14
4.1.3 Activation for Asynchronous Handover	15
4.1.4 Activation for Synchronous Handover	15
4.1.5 Activation for Secondary Channels in Multislot Configuration	15
4.1.6 Channel reactivation	15
4.2 Channel MODE MODIFY	16
4.3 Handover detection.....	16
4.4 Start of encryption	17
4.5 Measurement reporting.....	17
4.5.1 Basic measurement reporting.....	18
4.5.2 Measurement pre-processing	18
4.5.2.1 Pre-processing configuration.....	19
4.5.2.2 Pre-processed measurement reporting.....	19
4.5.3 Extended measurement reporting	19
4.6 Deactivate SACCH.....	20
4.7 Radio channel release	20
4.8 MS power control.....	20
4.9 Transmission power control	21
4.10 Connection failure	22
4.11 Physical context request	22
4.12 SACCH information modify	22
4.13 Talker detection.....	23
4.14 Listener detection	23
4.15 Remote Codec Configuration	23
4.16 Round Trip Delay Report.....	23
4.17 Pre-handover Warning	24
4.18 MultiRate Codec Configuration Change	24
4.19 MultiRate Codec Configuration Change Performed	25
4.20 TFO Report	25
4.21 TFO Modification Request.....	25
5 Common channel management procedures.....	26
5.1 Channel request by MS	26
5.2 Paging.....	26

5.3	Delete indication	26
5.4	CCCH load indication	27
5.5	Broadcast information modify.....	27
5.6	Short Message Cell Broadcast.....	27
5.7	IMMEDIATE ASSIGNMENT	30
5.8	Notification.....	31
6	TRX management procedures	31
6.1	Radio resource indication	31
6.2	SACCH filling information modify.....	32
6.3	Flow control	32
6.4	Error reporting.....	33
6a	Location services procedures	33
6a.1	LLP message transport	33
7	Error handling	34
7.1	General	34
7.2	Message discriminator error.....	34
7.3	Message type error	34
7.4	Message sequence error.....	34
7.5	General information element errors.....	34
7.6	Mandatory information element errors.....	34
7.7	Optional information element errors	35
7.8	Conditional information element errors	35
8	Message formats and contents.....	35
8.0	General	35
8.1	Transparent messages.....	36
8.2	Non-transparent messages (BSC-BTS specific messages).....	36
8.3	Radio link layer management messages	36
8.3.1	DATA REQUEST	37
8.3.2	DATA INDICATION.....	37
8.3.3	ERROR INDICATION.....	37
8.3.4	ESTABLISH REQUEST	37
8.3.5	ESTABLISH CONFIRM.....	38
8.3.6	ESTABLISH INDICATION	38
8.3.7	RELEASE REQUEST	38
8.3.8	RELEASE CONFIRM.....	38
8.3.9	RELEASE INDICATION	39
8.3.10	UNIT DATA REQUEST.....	39
8.3.11	UNIT DATA INDICATION	39
8.4	DEDICATED CHANNEL MANAGEMENT MESSAGES.....	39
8.4.1	CHANNEL ACTIVATION.....	40
8.4.2	CHANNEL ACTIVATION ACKNOWLEDGE.....	41
8.4.3	CHANNEL ACTIVATION NEGATIVE ACKNOWLEDGE.....	41
8.4.4	CONNECTION FAILURE INDICATION	42
8.4.5	DEACTIVATE SACCH.....	42
8.4.6	ENCRYPTION COMMAND	42
8.4.7	HANDOVER DETECTION.....	42
8.4.8	MEASUREMENT RESULT	42
8.4.9	MODE MODIFY	43
8.4.10	MODE MODIFY ACKNOWLEDGE.....	43
8.4.11	MODE MODIFY NEGATIVE ACKNOWLEDGE.....	44
8.4.12	PHYSICAL CONTEXT REQUEST	44
8.4.13	PHYSICAL CONTEXT CONFIRM	44
8.4.14	RF CHANNEL RELEASE.....	44
8.4.15	MS POWER CONTROL.....	44
8.4.16	BS POWER CONTROL.....	45
8.4.17	PREPROCESS CONFIGURE	45
8.4.18	PREPROCESSED MEASUREMENT RESULT	45
8.4.19	RF CHANNEL RELEASE ACKNOWLEDGE	45
8.4.20	SACCH INFO MODIFY	45

8.4.21	TALKER DETECTION	46
8.4.22	LISTENER DETECTION	46
8.4.23	REMOTE CODEC CONFIGURATION REPORT	46
8.4.24	ROUND TRIP DELAY REPORT	47
8.4.25	PRE-HANDOVER NOTIFICATION	47
8.4.26	MULTIRATE CODEC MODIFICATION REQUEST	47
8.4.27	MULTIRATE CODEC MODIFICATION ACKNOWLEDGE	47
8.4.28	MULTIRATE CODEC MODIFICATION NEGATIVE ACKNOWLEDGE	47
8.4.29	MULTIRATE CODEC MODIFICATION PERFORMED	48
8.4.30	TFO REPORT	48
8.4.31	TFO MODIFICATION REQUEST	48
8.5	COMMON CHANNEL MANAGEMENT MESSAGES	48
8.5.1	BCCH INFORMATION	49
8.5.2	CCCH LOAD INDICATION	49
8.5.3	CHANNEL REQUIRED	50
8.5.4	DELETE INDICATION	50
8.5.5	PAGING COMMAND	50
8.5.6	IMMEDIATE ASSIGN COMMAND	50
8.5.7	SMS BROADCAST REQUEST	51
8.5.8	SMS BROADCAST COMMAND	51
8.5.9	CBCH LOAD INDICATION	51
8.5.10	NOTIFICATION COMMAND	52
8.6	TRX MANAGEMENT MESSAGES	52
8.6.1	RF RESOURCE INDICATION	52
8.6.2	SACCH FILLING	52
8.6.3	OVERLOAD	53
8.6.4	ERROR REPORT	53
8.7	LOCATION SERVICES MESSAGES	53
8.7.1	LOCATION INFORMATION	53
9	Information element codings	54
9.1	Message discriminator	54
9.2	MESSAGE TYPE	54
9.3	Other information elements	56
9.3.1	Channel Number	57
9.3.2	Link Identifier	57
9.3.3	Activation Type	58
9.3.4	BS Power	59
9.3.5	Channel Identification	59
9.3.6	Channel Mode	60
9.3.7	Encryption information	62
9.3.8	Frame Number	62
9.3.9	Handover reference	62
9.3.10	L1 Information	63
9.3.11	L3 Information (message name)	63
9.3.12	MS Identity	63
9.3.13	MS Power	63
9.3.14	Paging Group	64
9.3.15	Paging Load	64
9.3.16	Physical Context	64
9.3.17	Access Delay	65
9.3.18	RACH Load	65
9.3.19	Request Reference	65
9.3.20	Release Mode	66
9.3.21	Resource Information	66
9.3.22	RLM Cause	66
9.3.23	Starting Time	67
9.3.24	Timing Advance	67
9.3.25	Uplink Measurements	67
9.3.26	Cause	68
9.3.27	Measurement result number	70
9.3.28	Message Identifier	70

9.3.29	SACCH Information	70
9.3.30	System Info Type	71
9.3.31	MS Power Parameters	72
9.3.32	BS Power Parameters	72
9.3.33	Pre-processing Parameters	73
9.3.34	Pre-processed Measurements	73
9.3.35	Full Immediate Assign Info	73
9.3.36	SMSCB Information	74
9.3.37	MS Timing Offset	74
9.3.38	Erroneous Message	74
9.3.39	Full BCCH Information (message name)	74
9.3.40	Channel Needed	75
9.3.41	CB Command type	75
9.3.42	SMSCB Message	76
9.3.43	CBCH Load Information	76
9.3.44	SMSCB Channel Indicator	76
9.3.45	Group call reference	77
9.3.46	Channel description	77
9.3.47	NCH DRX information	77
9.3.48	Command indicator	77
9.3.49	eMLPP Priority	78
9.3.50	UIC	78
9.3.51	Main channel reference	78
9.3.52	MultiRate configuration	79
9.3.53	MultiRate Control	79
9.3.54	Supported Codec Types	79
9.3.55	Codec Configuration	81
9.3.56	Round Trip Delay	82
9.3.57	TFO Status	82
9.3.58	LLP APDU	83
9.3.59	TFO transparent container	83
Annex A (informative): Change History		84
History		85

Foreword

This Technical Specification has been produced by the 3rd Generation Partnership Project (3GPP).

The contents of the present document are subject to continuing work within the TSG and may change following formal TSG approval. Should the TSG modify the contents of the present document, it will be re-released by the TSG with an identifying change of release date and an increase in version number as follows:

Version x.y.z

where:

- x the first digit:
 - 1 presented to TSG for information;
 - 2 presented to TSG for approval;
 - 3 or greater indicates TSG approved document under change control.
- y the second digit is incremented for all changes of substance, i.e. technical enhancements, corrections, updates, etc.
- z the third digit is incremented when editorial only changes have been incorporated in the document.

1 Scope

The present document specifies the general structure of layer 3 and traffic management procedures and messages used on the A-bis interface to support signalling procedures as defined in 3GPP TS 24.008 and 3GPP TS 44.018. Support for Location Services (LCS) related signalling, as defined in 3GPP TS 23.071, is also included. 3GPP TS 23.071 identifies new A-bis signalling to support BTS-embedded Type B LMUs as well as standalone, Type B LMUs. The standalone Type B LMU supports the layer 1 and 2 signalling for the A-bis as well as the Location Service message defined in the present document.

The use and general aspects of the Base Station Controller (BSC) to Base Station Transceiver (BTS) interface (the A-bis interface) are given in 3GPP TS 48.051.

Network management procedures and messages for the A-bis interface are defined in 3GPP TS 08.59.

The functional split between BSC and BTS is defined in 3GPP TS 48.052. The procedures and messages required to support this split are defined in detail in the present document.

1.1 References

The following documents contain provisions which, through reference in this text, constitute provisions of the present document.

- References are either specific (identified by date of publication, edition number, version number, etc.) or non-specific.
- For a specific reference, subsequent revisions do not apply.
- For a non-specific reference, the latest version applies. In the case of a reference to a 3GPP document (including a GSM document), a non-specific reference implicitly refers to the latest version of that document *in the same Release as the present document*.

- [1] 3GPP TR 21.905: "Vocabulary for 3GPP Specifications".
- [2] 3GPP TS 43.020: "Security related network functions".
- [2a] 3GPP TS 23.071: "Location Services; Functional description – Stage 2".
- [3] 3GPP TS 44.004: "Layer 1 General requirements".
- [4] 3GPP TS 44.005: "Data Link (DL) layer General aspects".
- [5] 3GPP TS 44.006: "Mobile Station - Base Station System (MS - BSS) interface Data Link (DL) layer specification".
- [6] 3GPP TS 24.008: "Mobile radio interface layer 3 specification; Core Network Protocols; Stage 3".
- [7] 3GPP TS 44.012: "Short Message Service Cell Broadcast (SMSCB) support on the mobile radio interface".
- [7a] 3GPP TS 44.071: "Mobile radio interface layer 3 Location Services (LCS) specification".
- [8] 3GPP TS 45.002: "Multiplexing and multiple access on the radio path".
- [9] 3GPP TS 45.005: "Radio transmission and reception".
- [10] 3GPP TS 45.008: "Radio subsystem link control".
- [11] 3GPP TS 45.009: "Link Adaptation".
- [12] 3GPP TS 45.010: "Radio subsystem synchronization".
- [13] 3GPP TS 48.006: "Signaling transport specification mechanism for the Base Station System – Mobile-services Switching Centre (BSS - MSC) interface".

- [14] 3GPP TS 48.008: "Mobile-services Switching Centre – Base Station System (MSC-BSS) interface; Layer 3 specification".
- [15] 3GPP TS 48.051: "Base Station Controller - Base Transceiver Station (BSC - BTS) interface; General aspects".
- [16] 3GPP TS 48.052: "Base Station Controller - Base Transceiver Station (BSC - BTS) interface; Interface principles".
- [17] 3GPP TS 48.056: "Base Station Controller - Base Transceiver Station (BSC - BTS) interface; Layer 2 specification".
- [18] 3GPP TS 26.103: "Speech Codec List for GSM and UMTS".
- [19] 3GPP TS 44.018: "Radio Resource Control Protocol".

1.2 Abbreviations

For the purposes of the present document, the abbreviations defined in 3GPP TR 21.905 apply.

2 Protocol model

A model for L3 can be found in figure 2.1.

L2 addressing is made to TRX (or BCF) using the TEI of LAPD. Different L2 links are used for traffic management messages (RSL, Radio Signalling Link), network management messages (OML, Operation & Maintenance Link) and L2 management messages (L2ML, Layer 2 Management Link).

For traffic management, two types of signalling messages have been defined:

Transparent Messages: Messages which are forwarded by BTS without interpretation or changes.

Non-Transparent Messages: Messages which are sent only between BSC and BTS and which BTS is acting upon or which are the results of BTS actions.

In addition, the messages have been grouped into four main groups: Radio Link Layer Management, Dedicated Channel Management, Common Channel Management and TRX Management messages.

Discrimination between these types and groups is based on the Message Discriminator which is sent as the first octet in all messages. Transparent and non-transparent messages are discriminated by a transparency flag (T-bit) in the Message Discriminator. Transparent messages are merely forwarded to L2 on the radio interface.

In order to address the relevant radio channel, a Channel Number element is included to support the distribution of messages to relevant physical channels on the TRX. A Link Identifier element supports the distribution on logical links/channels on the radio interface (compare the DLCI element of the A interface, 3GPP TS 48.006).

All messages in this GTS are to be transmitted on the A-bis interface using the I format of LAPD, except for MEASUREMENT RESULT which is sent in UI format.

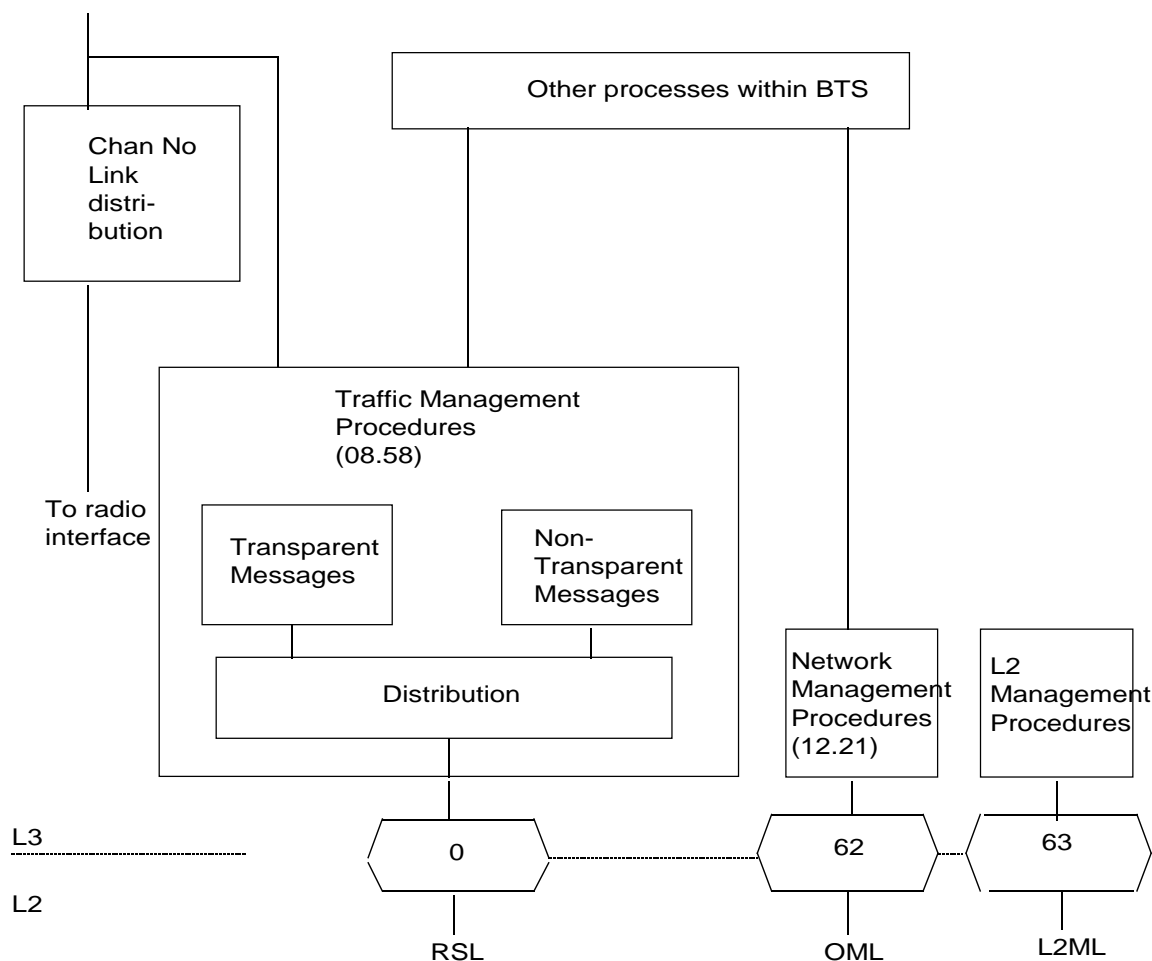

Figure 2.1/48.058: L3 model

3 Radio Link Layer Management Procedures

This sub-clause describes procedures related to the management of a link layer connection on the radio path.

3.1 Link establishment indication

This procedure is used by BTS to indicate to BSC that a layer 2 link on the radio path has been established in multi-frame mode at the initiative of an MS. BSC can use this indication to set up an SCCP connection to MSC.

Upon reception of a SABM frame on a link on an active channel, the BTS sends an ESTablish INDication message to BSC. The message contains the contents of the information field of the SABM frame if present.

The procedure is used in all establishment cases, for all channels and all SAPIs.

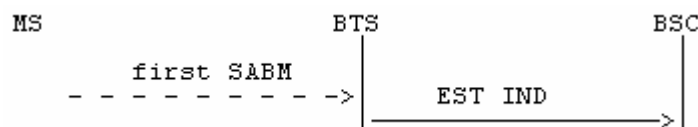

3.2 Link establishment request

This procedure is used by BSC to request the establishment of a link layer connection in multi-frame mode on the radio path.

The procedure is started by BSC sending an ESTablish REQuest message to BTS. BTS then establishes the link by sending an SABM frame. Upon reception of the acknowledgement (UA-frame) from MS, BTS sends an ESTablish CONFirm message to BSC.

In case of a failure, BTS sends a RELease INDication and an ERRor INDication message to BSC (cf. 3GPP TS 44.006).

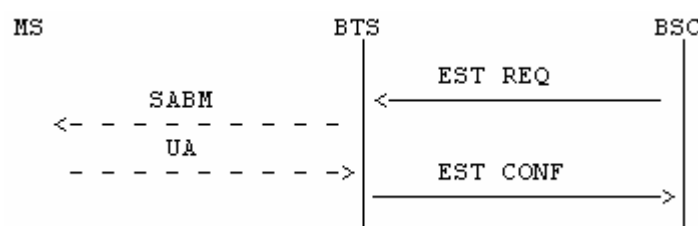

3.3 Link release indication

This procedure is used by BTS to indicate to BSC that a link layer connection on the radio path has been released at the initiative of an MS.

When receiving a DISC frame on a link layer connection in multi-frame mode, BTS sends a RELease INDication message to BSC. (If the link layer is in idle mode, BTS will send a DM frame to MS but does not notify BSC.)

Collision cases are treated as specified in 3GPP TS 44.006.

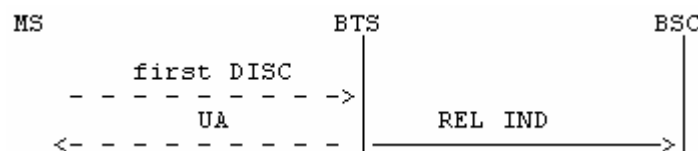

3.4 Link release request

This procedure is used by BSC to request the release of a link layer connection on the radio path.

The procedure is started by BSC sending a RELease REQuest message to BTS. BTS then sends a DISC frame to MS. When it has received the acknowledgement (UA or DM frame), BTS sends a RELease CONFirm message to BSC.

Collision cases are treated as specified in 3GPP TS 44.006.

If BTS has repeated the DISC frame N200 times, BTS sends a RELease INDication and an ERRor INDication message to BSC (cf. 3GPP TS 44.006).

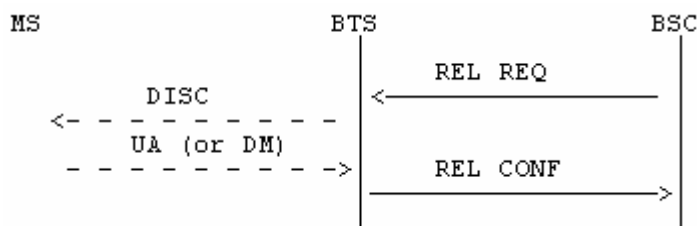

3.5 Transmission of a transparent L3-Message in acknowledged mode

This procedure is used by BSC to request the sending of a L3 message to MS in acknowledged mode.

BSC sends a DATA REQuest message to BTS. The message contains the complete L3 message to be sent in acknowledged mode.

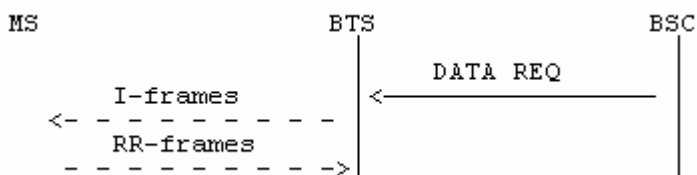

3.6 Reception of a transparent L3-Message in acknowledged mode

This procedure is used by BTS to indicate the reception of a L3 message in acknowledged mode.

BTS sends a DATA INDication message to BSC. The message contains the received L3 message.

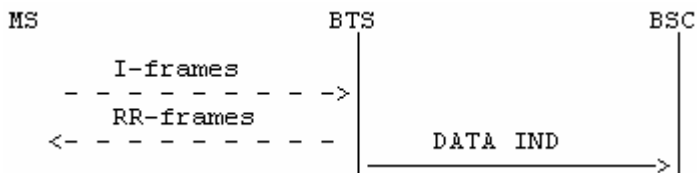

3.7 Transmission of a transparent L3-Message in unacknowledged mode

This procedure is used by BSC to request the sending of a L3 message to MS in unacknowledged mode.

BSC sends a UNIT DATA REQuest message to BTS. The message contains the L3 message to be sent to MS in unacknowledged mode.

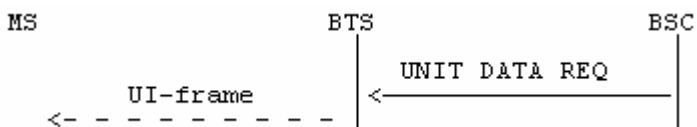

3.8 Reception of a transparent L3-Message in unacknowledged mode

This procedure is used by BTS to indicate the reception of a L3 message in unacknowledged mode.

BTS sends a UNIT DATA INDication message to BSC. The message contains the received L3 message.

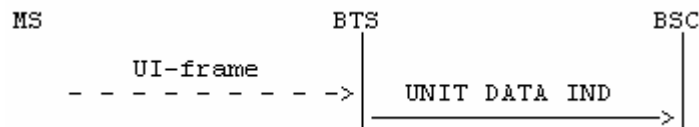

3.9 Link error indication

This procedure is used by BTS to indicate an abnormal case such as the following.

- a protocol error as specified in 3GPP TS 44.006;
- a link layer failure, i.e. the repetition of an I-frame N200 times without an acknowledgement;
- the repetition of an SABM or DISC frame N200 times without an acknowledgement;
- the reception of an SABM frame in multi-frame established state.

When such an event has occurred, BTS notifies BSC by sending an ERROR INDication message containing the relevant cause information.

A BTS that supports enhanced power control (EPC) shall activate a channel in EPC mode if so ordered by the BSC in the CHANNEL ACTIVATION message. Further, it shall use enhanced power control procedures as defined in 3GPP TS 45.008 for MS (uplink) power control and/or BS (downlink) power control if so ordered by the BSC in the CHANNEL ACTIVATION message (or the BS POWER CONTROL or MS POWER CONTROL messages).

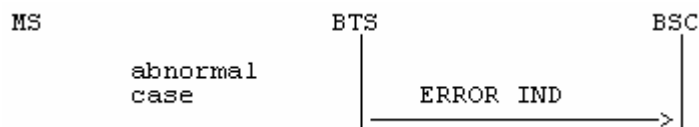

Dedicated channel management procedures

4.1 Channel activation

This procedure is used to activate a channel at the BTS for an MS which later will be commanded to this channel by an IMMEDIATE ASSIGN, an ASSIGN CoMmanD, an ADDitional ASSIGNment; a NOTIFICATION, a CHANNEL RELEASE (with a Channel description) a HANdOver CoMmanD or a CONFIguration CHange CoMmanD message.

In the handover case, the procedure is used between the target BSC and the target BTS to activate a channel for a subsequent handover from the old BTS.

4.1.1 Signalling Procedure

BSC determines what channel shall be used and starts up that channel at BTS by sending a CHANnel ACTIVation message to the relevant TRX. This message contains the reason for the activation (immediate assignment, assignment, asynchronous/synchronous handover, additional assignment, activation of a secondary channel in a multislot configuration), the identification of the channel to be used (channel no) and a complete description of the channel (full/half rate, speech/data, coding/rate adaption, hopping sequence, encryption key etc.).

If the Encryption Information field is present, the activation is done with ciphering active. If the Encryption Information element is not present, activation is done without ciphering.

After activating the channel as requested, TRX responds with the CHANnel ACTIVation ACKnowledge message. This message contains the current frame number at BTS. The frame number is used by BSC to determine the Starting Time parameter to be included in the following assignment message to MS. (A suitable number has to be added to current frame number to take all possible signalling delays into account).

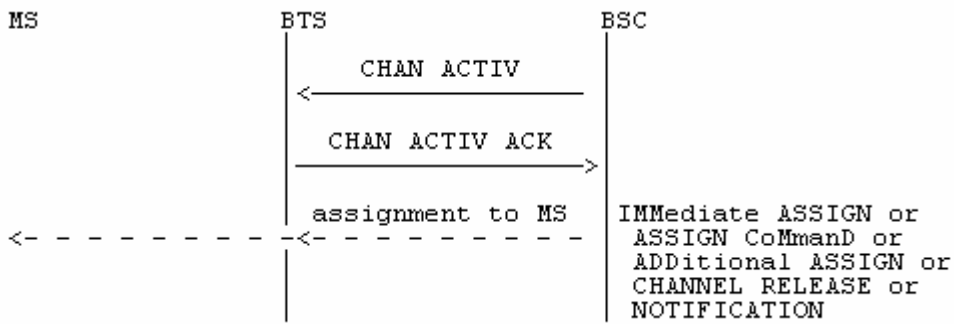

If the TRX for some reason cannot activate the resource as requested by the CHANnel Activation message, the TRX shall return a CHANnel ACTIVation Negative ACKnowledge message with the most appropriate cause value.

Possible cause values may be:

- O&M intervention (e.g. channel blocked);
- resource not available (e.g. speech coder, encryption device);
- equipment failure;
- channel already activated;
- etc.

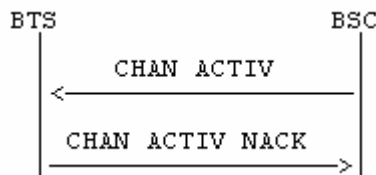

In the handover case, the procedure is initiated by the target BSC when this receives the HANDOver REQuest message from MSC (or autonomously by BSC for BSC internal handover). The BSC sends a CHANnel ACTIVation message to the relevant TRX. The message contains the Handover Reference value which can be used by the BTS to check the Handover Access from MS. After activation of the channel TRX responds with a CHANnel ACTIVation ACKnowledge message containing the current frame number at BTS.

The BSC can then determine the Starting Time parameter to be included in the HANDOver REQuest ACKnowledge message to MSC (and the HANDOver CoMmanD message to MS).

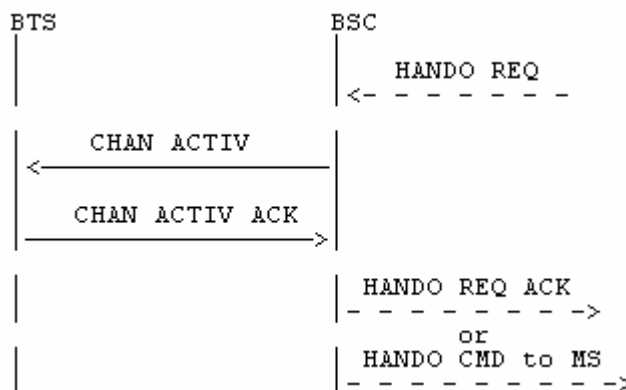

4.1.2 Activation for Intra-Cell Channel Change

This activation precedes the Immediate Assignment, Assignment or Additional assignment procedures. The Timing Advance element must be included in the CHANNEL ACTIVATION message.

BTS activates the channel and starts transmission and reception on the main channel in the indicated mode. Ciphering is started if so indicated in the encryption information.

The reception and transmission on SACCH is also started immediately.

If the BS and/or MS power elements and/or the Physical Context element are present, the reception and transmission processes and the L1-header of SACCH are initialized accordingly.

4.1.3 Activation for Asynchronous Handover

BTS starts transmission immediately on the main channel in the indicated mode and with encryption if so indicated. If the MS Power element is present the BTS may start transmission also on the SACCH.

When receiving a correct access burst with the correct handover reference, BTS starts the normal reception process on the main channel in the indicated mode and starts receiving (and sending if not started earlier) on SACCH. Deciphering is started if so indicated. The handover detection procedure towards BSC is also started.

4.1.4 Activation for Synchronous Handover

BTS starts transmission immediately on the main channel in the indicated mode and with encryption if so indicated. If the MS Power and Timing Advance element are present, BTS shall start transmission also on SACCH with the timing advance and MS power control parameters indicated. If only the MS power element is present the BTS may start transmission also on the SACCH.

When receiving a correct access burst with the correct handover reference, BTS starts the normal reception process on the main channel in the indicated mode, with deciphering applied if so indicated, and starts receiving (and sending if not started earlier) on SACCH. The handover detection procedure towards BSC is also started. Alternatively, the reception of a correctly decoded frame from the MS on the main channel, in the indicated mode and deciphering applied if so indicated, allows the start of sending on SACCH (if not already started) and starts the handover detection procedure towards the BSC.

NOTE: The activation for synchronous handover can be used for pseudo synchronized handover.

4.1.5 Activation for Secondary Channels in Multislot Configuration

BTS activates the channel and starts transmission and reception on the traffic and SACCH channels in the indicated mode. Ciphering is applied if so indicated in the encryption information.

If the BS and/or MS power elements and/or the Physical Context element are present, the reception if applicable and transmission processes and the L1-header of SACCH are initialized accordingly.

4.1.6 Channel reactivation

This procedure is used by BSC to request a reactivation of an active channel. During the reactivation, information flows, e.g., user information such as speech or data, that are common for the two phases of operation, are not interrupted.

BSC initiates the procedure by sending a CHANNEL ACTivation message to BTS where the activation type indicates "reactivation", the BTS shall reactivate the channel with the new parameters. After having successfully reactivate the channel with the parameters supplied the BTS responds with a CHANNEL ACTivation ACKnowledge message to BSC.

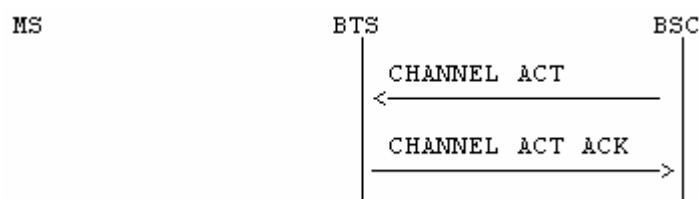

If the TRX for some reason cannot reactivate the channel as requested in the CHANNEL ACTIVATION message, the TRX shall return a CHANNEL ACTIVATION Negative ACKnowledge message with the most appropriate cause value.

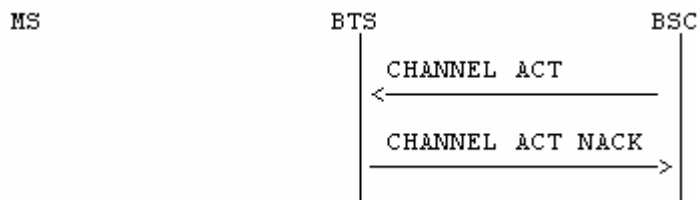

4.2 Channel MODE MODIFY

This procedure is used by BSC to request a change of the channel mode and/or a change between uni-directional and bi-directional channel types of an active channel. In addition, for secondary channels in a multislot configuration, the procedure can be used by BSC to request a change in the encryption information of an active channel.

BSC initiates the procedure by sending a MODE MODIFY message to BTS. The message contains the new mode to be used. After having changed to the new mode, BTS responds with a MODE MODIFY ACKnowledge message to BSC.

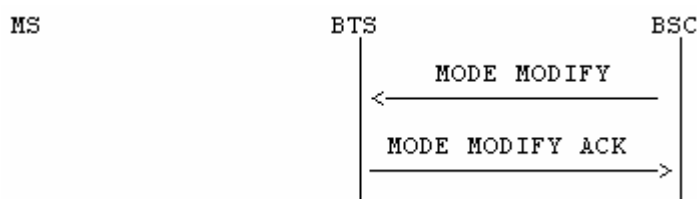

If the TRX for some reason cannot modify the channel as requested in the MODE MODIFY message, the TRX shall return a MODE MODIFY Negative ACKnowledge message with the most appropriate cause value.

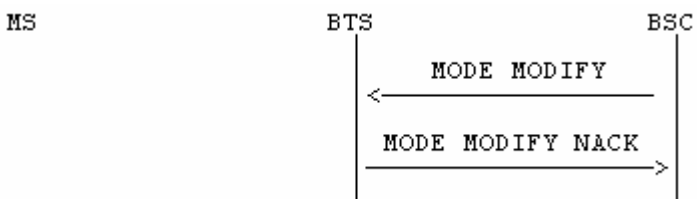

4.3 Handover detection

This procedure is used between the target BTS and BSC when a handed over MS accesses the new BTS.

The procedure is initiated by BTS upon detection of an MS on a channel activated for handover as described in sub-clause 4.1.3 for the asynchronous handover and in sub-clause 4.1.4 for synchronous handover.

In case of an asynchronous handover, BTS builds the PHYSICAL INFORMATION message as specified in 3GPP TS 44.018, sends the message to MS in unacknowledged mode on the main signalling link and starts timer T3105. A HANDOVER DETECTION message is sent to BSC. This message contains the measured delay of the access burst. If the timer expires before the reception of a correctly decoded frame from MS, BTS repeats the PHYSICAL INFORMATION message to MS as specified in 3GPP TS 44.018. If the PHYSICAL INFORMATION message has been repeated N_{y1} times without a correctly decoded frame being received from MS, the BTS shall send a CONNECTION FAILURE message to BSC with the cause value "handover access failure".

In case of a synchronous handover, BTS only sends a HANDOVER DETECTION message to BSC (no PHYSICAL INFORMATION message sent to MS). If the handover detection is based on the detection of an handover access burst with the correct handover reference, see sub-clause 4.1.4, the measured delay of the access burst is included in the HANDOVER DETECTION message.

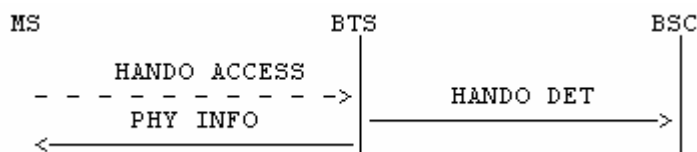

4.4 Start of encryption

This procedure is used to start encryption according to the procedure defined in 3GPP TS 44.018.

The procedure is initiated by BSC upon reception of the CIPHER MODE COMMAND message from MSC (see 3GPP TS 48.008).

BSC sends the ENCRyption CoMmanD message to the relevant TRX and channel. In case of a Multislot configuration the message is sent only to the TCH used as a main channel (defined in 3GPP TS 45.002). The message contains all information required to select and load the user data and encryption device with the appropriate key and also the complete Cipherring Mode Command message to be sent to MS.

After receipt of this message, TRX sends the CIPHERing MODE CoMmanD message to MS in unciphered form and starts deciphering as described in 3GPP TS 44.018 and 3GPP TS 43.020. The start of deciphering and the sending of the Cipherring Mode Command message to MS must be done simultaneously.

When receiving the CIPHERing MODE CoMmanD, MS starts both deciphering and enciphering and sends the CIPHERing MODE CoMplete message.

TRX starts enciphering upon reception of any correct layer 2 frame which is received after start of deciphering.

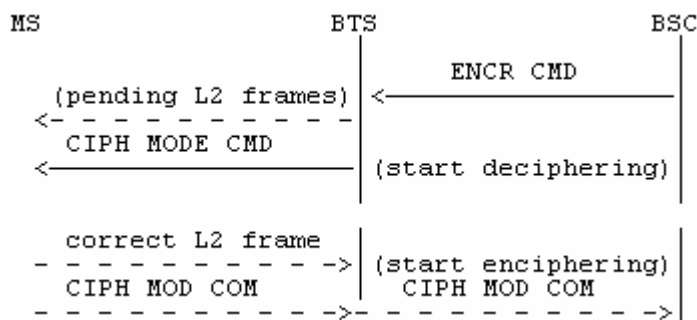

If the TRX for some reason can not perform the enciphering as requested in the ENCRYPTION COMMAND, the TRX shall return an ERROR REPORT message, e.g., with the cause "Encryption algorithm not implemented".

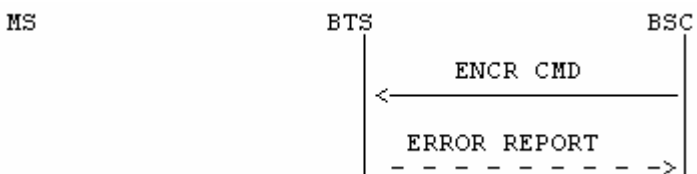

4.5 Measurement reporting

These procedures are used to report to BSC all parameters and measurement results required by BSC for handover requirement determination. One procedure is also used to report to the BSC extended measurements made by Mobile Stations.

MS measures downlink received signal level and quality from the serving cell and received signal level from surrounding cells as defined in 3GPP TS 45.005 and 3GPP TS 45.008. The measurement results are reported in Measurement Report messages sent in every SACCH block (every 480 ms) or, in case SACCH is used also for other signalling, in at least every second SACCH block (every 960 ms).

In addition, the MS which implements ECSD options shall use fast inband procedure for downlink quality reporting if the use of such procedure has been ordered by the BSC.

In addition, an MS on a channel in enhanced power control (EPC) mode shall measure the quality on the downlink and send EPC Downlink Quality Reports in each EPCCH block (every 120 ms) as defined in 3GPP TS 45.008, if so ordered by the BSC (see 3GPP TS 44.018).

The TRX measures the received signal level and the quality on the uplink of the current channel. The averaging period is one SACCH block period (same as the basic period for MS).

In addition, a TRX that supports EPC shall measure the quality on the uplink for each channel in EPC mode. The averaging period is one EPC reporting period (see 3GPP TS 45.008).

These measurements made by MS and TRX form the basic raw data for the handover algorithms in BSC/MSC. The support of forwarding this raw data over the A-bis interface is mandatory for both BTS and BSC. The procedure to be used for this basic measurement reporting is defined in sub-clause 4.5.1.

In addition, the BTS and BSC may optionally support some pre-processing in BTS of these basic measurements. The additional and optional procedures required to support this pre-processing are defined in sub-clause 4.5.2.

Extended measurements made by MS shall be forwarded to the BSC, using the same procedure as for "normal" measurements. This case is described in sub-clause 4.5.3.

4.5.1 Basic measurement reporting

This procedure is used by BTS to report the results of the basic radio measurements made by MS and TRX according to 3GPP TS 45.008 and 3GPP TS 45.005. The support of this procedure is mandatory in all BTS:s and all BSC:s. It is the default procedure to use unless otherwise indicated (see sub-clause 4.5.2.1).

TRX reports all these measurements in MEASUREMENT RESULT messages to BSC. The sending of the MEASUREMENT RESULT messages is synchronized with the reception of SACCH blocks from MS.

If an uplink SACCH block does not contain a MEASUREMENT REPORT or an EXTENDED MEASUREMENT REPORT (see sub-clause 4.5.3) from MS (e.g. when it sends a short message), only the uplink measurement results are included with an indication that the MS measurements are missing.

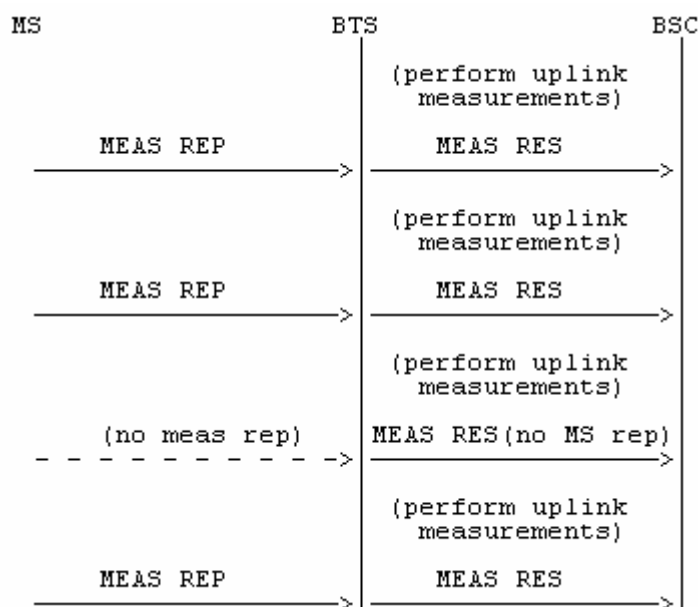

4.5.2 Measurement pre-processing

These additional and optional procedures are included to support some pre-processing in BTS of radio measurement data. When used, they may replace the basic procedure defined in sub-clause 4.5.1. However, it shall be possible to change back to the basic procedure.

Pre-processing in BTS must not affect the procedures on the A interface (e.g. the Handover Candidate Enquiry procedure).

4.5.2.1 Pre-processing configuration

This procedure is used by BSC to modify the pre-processing parameters according to reported communication conditions (e.g. degradation of the communication).

In order to change the parameters, BSC sends a PREPROCESS CONFIGURE message to BTS.

A parameter setting in the PREPROCESS CONFIGURE message indicates if the basic procedure defined in sub-clause 4.5.1 or pre-processing is to be used.

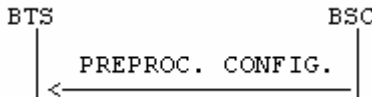

4.5.2.2 Pre-processed measurement reporting

This procedure is used by BTS to report the results of measurement pre- processing.

To report the results, BTS sends a PREPROCESSED MEASUREMENT RESULT message to BSC.

The conditions to send the message are set in the PREPROCESS CONFIGURE message.

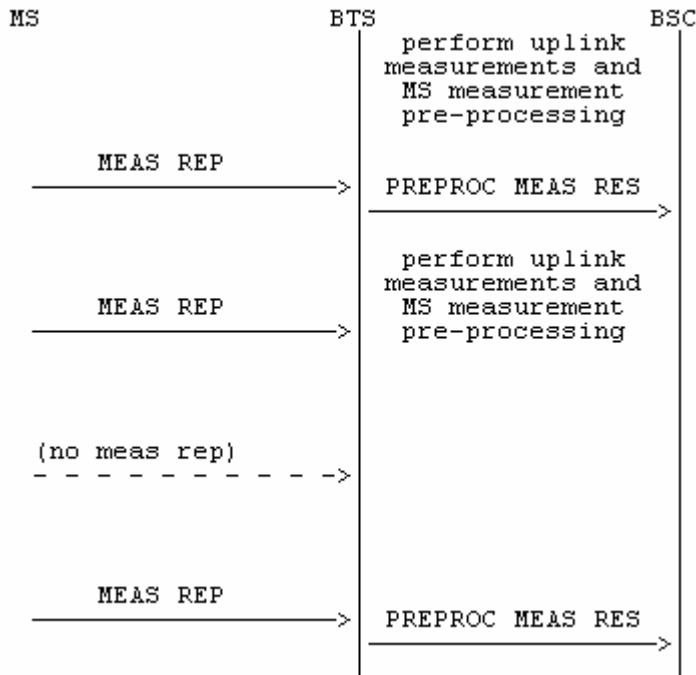

4.5.3 Extended measurement reporting

This procedure is used by BTS to report the results of the extended measurements made by MS according to 3GPP TS 45.008.

If an uplink SACCH block contains an EXTENDED MEASUREMENT REPORT from MS, it shall be forwarded to the BSC using the same procedure as when reporting regular measurement reports from an MS. Though, no measurement pre-processing is possible.

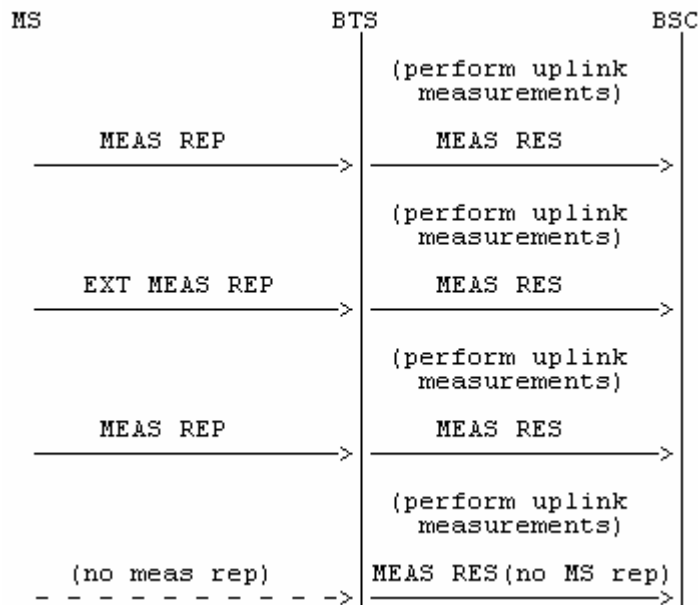

4.6 Deactivate SACCH

This procedure is used by BSC to deactivate the SACCH at BTS according to the Channel Release procedure defined in 3GPP TS 44.018.

When sending the Channel Release message to MS, BSC also sends the DEACTIVATE SACCH message to BTS to deactivate the SACCH (see 3GPP TS 44.018, Channel Release procedure).

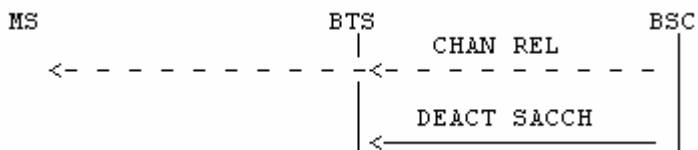

4.7 Radio channel release

This procedure is used by BSC to release a radio channel which is no longer needed.

When an activated radio channel is no longer needed, BSC sends an RF CHANNEL RELEASE message to the relevant TRX and channel. After having released the addressed resources, the BTS sends a RF CHANNEL RELEASE ACKNOWLEDGE to BSC.

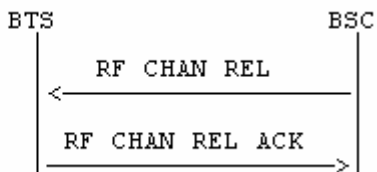

4.8 MS power control

This procedure is used by BSC to set the MS power level or the parameters required by TRX for the control of MS power.

The initial parameters are set by BSC in the CHANNEL ACTIVATION message (see Channel Activation procedure). If these parameters are to be changed for an active channel, BSC sends a MS POWER CONTROL message to TRX.

The support of the power control and the enhanced power control performed by BTS is optional.

If power control is supported by BTS and it is to be used, this is indicated by optional parameters in the MS POWER CONTROL message (or the CHANNEL ACTIVATION message). Based on the measurements performed on the uplink, TRX then attempts to keep the power control parameters within the limits set by the MS POWER CONTROL message (or by the CHANNEL ACTIVATION message) by changing the MS Power Level field of the L1 header sent to MS in each SACCH block. MS confirms the power in the uplink L1 header.

When the BTS supports MS power control the BSC can modify the MS power parameters during the connection (e.g. because of a classmark change) by sending a MS POWER CONTROL message containing the new parameters.

The MS POWER CONTROL and the CHANNEL ACTIVATION message must also contain a maximum power permitted for the MS.

In addition, the BTS which implements ECSD option shall use fast inband procedure for fast power control if the use of such procedure has been ordered by the BSC.

A BTS that supports enhanced power control (EPC) shall use EPC procedures for MS (uplink) power control (see 3GPP TS 45.008) if so ordered by the BSC in the MS POWER CONTROL message (or CHANNEL ACTIVATION message). Based on the measurements performed on the uplink, TRX then attempts to keep the power control parameters within the limits set by the MS POWER CONTROL message (or by the CHANNEL ACTIVATION message) by sending EPC Uplink Power Control Commands to the MS in each EPCCH block. MS confirms the power in the uplink L1 header on the SACCH.

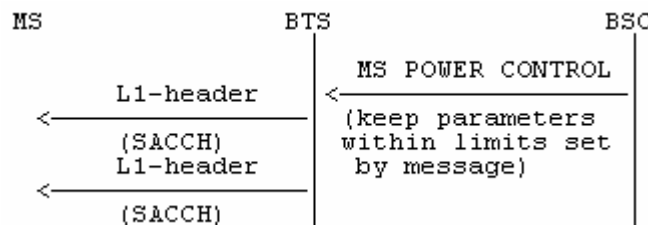

4.9 Transmission power control

This is an optional procedure which is used between BSC and BTS to set the TRX transmission power level or the parameters required by TRX for the control of TRX transmission power.

The initial parameters are set by BSC in the CHANNEL ACTIVATION message (see Channel Activation procedure). If these parameters are to be changed for an active channel, BSC sends a BS POWER CONTROL message to TRX.

The support of the power control, the fast power control and the enhanced power control performed by BTS are optional.

If power control is supported by BTS and it is to be used, this is indicated by optional parameters in the BS POWER CONTROL message (or the CHANNEL ACTIVATION message). Based on the Measurement Report messages sent by MS, the TRX will then attempt to keep the power control parameters within the limits set in the BS POWER CONTROL message (or by the CHANNEL ACTIVATION message) by changing the transmitted power on that channel.

If fast power control mechanism is supported by BTS and is to be used, this is indicated by optional parameters in the BS POWER CONTROL message (or by the CHANNEL ACTIVATION message). Based on the Fast Measurement Report messages sent by MS, the TRX will then attempt to keep the power control parameters within the limits set in the BS POWER CONTROL message (or by the CHANNEL ACTIVATION message) by changing the transmitted power on that channel.

A BTS that supports enhanced power control (EPC) shall use EPC procedures for BS (downlink) power control (see 3GPP TS 45.008) if so ordered by the BSC in the BS POWER CONTROL message (or CHANNEL ACTIVATION message). Based on the EPC Downlink Quality Reports sent by the MS, the TRX shall then attempt to keep the power control parameters within the limits set in the BS POWER CONTROL message (or by the CHANNEL ACTIVATION message) by changing the transmitted power on that channel.

NOTE: The EPC mode field is only valid in the channel activation message.

The maximum power of the TRX is determined from network planning criteria. However, BSC may indicate a lower maximum power in the BS POWER CONTROL message (or the CHANNEL ACTIVATION message).

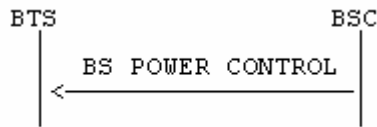

4.10 Connection failure

This procedure is used by BTS to indicate to BSC that an active connection has been broken (e.g. due to a radio link failure as defined in 3GPP TS 45.008).

When BTS detects that a connection has been broken, BTS sends a CONNecTion FAILure INDication message to BSC with the most proper cause value. Further actions are defined in 3GPP TS 44.018.

Some possible cause values are:

- radio link failure (as defined in 3GPP TS 45.008);
- hardware failure (e.g. transcoder failure);
- etc.



4.11 Physical context request

This is an optional procedure which allows the BSC to obtain information on the "physical context" of a radio channel just prior to a channel change. This information may be forwarded to the new TRX (possibly in another collocated cell).

The procedure is initiated by BSC sending a PHYsical CONTEXT REQuest message to TRX. TRX responds with a PHYsical CONTEXT CONFirm message which contains information on the "physical context" of the channel.

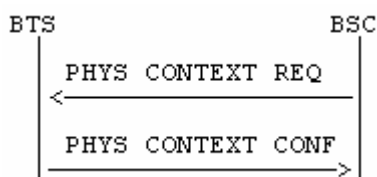

4.12 SACCH information modify

This procedure is used by the BSC to modify the SACCH filling information (System Information) sent on an individual SACCH channel. For this purpose, the BSC sends a SACCH INFO MODIFY message to the BTS. The SACCH filling information as given in the SACCH INFO MODIFY message shall be used on the indicated channel until the channel is released or the information is changed by another SACCH INFO MODIFY message.

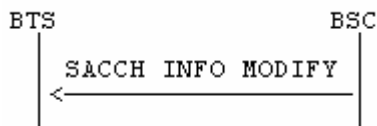

4.13 Talker detection

The procedure is used by the BTS during the period the channel is activated for a voice group call. Upon detection of an MS on a channel activated for group call as specified in sub-clause 4.1, the BTS builds the VGCS UPLINK GRANT message as specified in 3GPP TS 44.018, sends the message to the MS in unacknowledged mode on the main signalling link and starts timer T3115. A TALKER DETECTION message is sent to the BSC. This message contains the measured delay of the access burst. If the timer expires before the reception of a correctly decoded frame from the MS, the BTS repeats the VGCS UPLINK GRANT message to the MS as specified in 3GPP TS 44.018. If the VGCS UPLINK GRANT message has been repeated $Ny2$ times without a correctly decoded frame being received from the MS, the BTS shall send a CONNECTION FAILURE INDICATION message to the BSC with cause value "talker access failure".

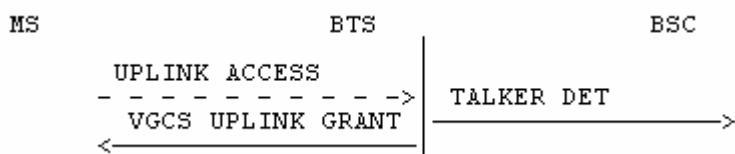

4.14 Listener detection

The procedure is used by the BTS during the period the channel is activated for a voice group call. Upon detection of an uplink access having the value reserved for replying to an uplink access request as specified in sub-clause 4.1. The BTS builds the LISTENER DETECTION message and sends the message to the BSC. This message contains the measured delay of the access burst.

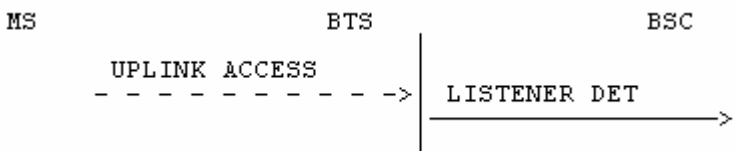

4.15 Remote Codec Configuration

This procedure is used by the BTS to report to the BSC the codec information received from the remote BSS prior to a MultiRate Codec TFO establishment or within TFO. This information can be used by the BSC to solve potential codec type and codec mode mismatches.

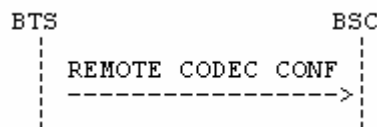

4.16 Round Trip Delay Report

This procedure is used by the BTS to report to the BSC the BTS to Transcoder or BTS to Remote BTS round trip transmission delay. This information can be used by the BSC to set the correct timing for a pre-handover warning and to optimise the AMR Configuration and/or Adaptation algorithm.

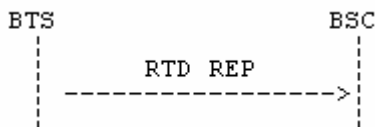

4.17 Pre-handover Warning

This procedure is used by the BSC to notify the serving BTS that a handover is going to be performed and allow the serving BTS to take the necessary steps in preparation of the handover (adaptation freezing for MultiRate Codec, TFO discontinuation,....). The Pre-handover Warning may disable (withdraw the 'general authorisation' of) the RATSCCH mechanism between BTS and MS for a while or permanently to ensure consistent configurations in BSC, BTSs and MS during and after handover. The BSC shall provide to the BTS the codec configuration parameters after Handover.

In case the announced handover has failed, the BSC sends the Pre-handover Notification again to the serving BTS, this time with the codec configuration parameters as before the handover attempt in order to re-establish the BTS operation (adaptation enable for MultiRate Codec, TFO enable, RATSCCH authorisation, ...).

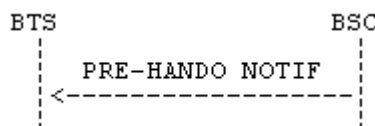

4.18 MultiRate Codec Configuration Change

This procedure is used by the BSC to authorise the BTS to change the MultiRate Codec Configuration to solve a codec mismatch prior to TFO establishment or within TFO. The BTS shall use the RATSCCH inband signalling with the MS as defined by Rec 3GPP TS 45.009.

Once the MultiRate Codec Configuration has been changed, the BTS shall send a MultiRate CODEC MOD ACK to the BSC to acknowledge the execution of the codec change. The MultiRate CODEC MOD ACK contains the final MultiRate Codec configuration.

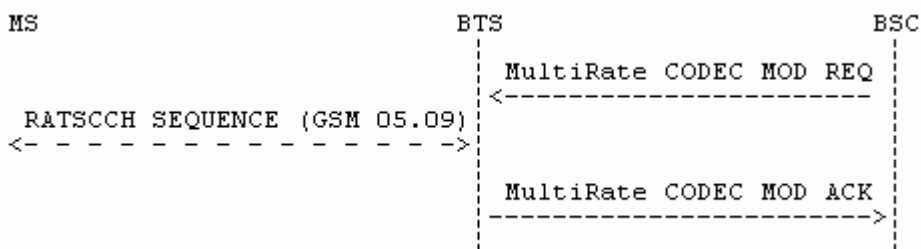

If for any reason, the BTS is not able to complete the MultiRate Codec Configuration change, it should send a MultiRate CODEC MOD Negative ACK with the most appropriate cause.

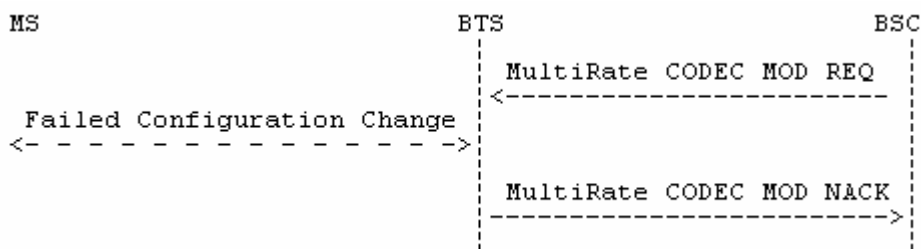

Possible causes are:

- tbd

This procedure is also used by the BTS to indicate to the BSC the optimal codec configuration for TFO, in the case where the TC or the BTS runs the TFO algorithm, and the BSC is responsible for changing the codec configuration. The BSC does not acknowledge this message.



4.19 MultiRate Codec Configuration Change Performed

This procedure is used by the BTS to report to the BSC that a MultiRate Codec Modification was performed using the RATSCCH in-band signalling capability. The BTS shall report the MultiRate codec configuration after the completion of the procedure.

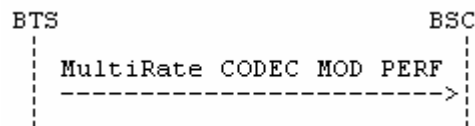

4.20 TFO Report

This procedure is used by the BTS to report to the BSC that TFO (based on AMR) is established, or is not in operation anymore.

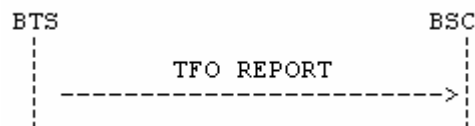

4.21 TFO Modification Request

This procedure is used by the BSC to change the TFO configuration while operating with AMR: enabling or disabling TFO.

This procedure shall be used only during an established call. At call setup, Channel Activation procedure shall be used. During an in-call modification from data to speech, Mode Modify procedure shall be used.

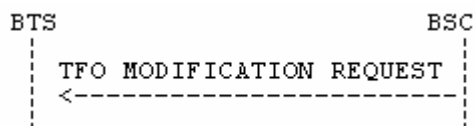

5 Common channel management procedures

5.1 Channel request by MS

The procedure is initiated by TRX upon detection of a random access from an MS (CHANnel REQuest message from MS). TRX then sends a CHANnel ReQuired message to BSC containing the Request Reference parameter (random number selected by MS plus some low order bits of the TDMA frame number for the access) and the measured delay of the Access Burst.

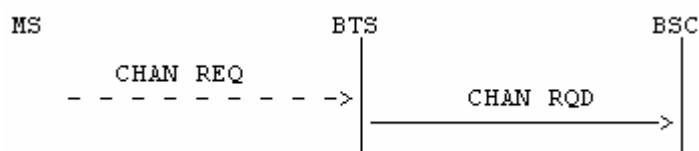

5.2 Paging

This procedure is used to request the paging of one mobile station on a given paging subchannel.

The paging of an MS is initiated by BSC sending a PAGing CoMmanD message to BTS. The message contains the MS identity (TMSI or IMSI), the paging population number of the MS, optionally an indication for the MS about which combination of channels will be needed for the subsequent transaction related to the paging and optionally an indication of the eMLPP priority of the call.

The PAGING REQuest messages to be sent on the radio path are built and sent by BTS.

The use by BTS of the "extended paging" facilities and the general downlink scheduling of the downlink CCCH is operator dependant and is not specified in this GTS. This process may also be influenced by O&M procedures.

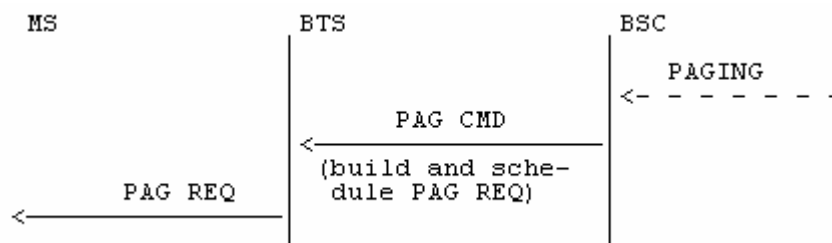

5.3 Delete indication

This procedure is used by BTS to indicate that due to overload on the downlink CCCH, an IMMEDIATE ASSIGN COMMAND has been deleted.

For that purpose BTS sends a DELETE INDication message to BSC.



5.4 CCCH load indication

This procedure is used by a BTS to inform the BSC of the load on a particular CCCH timeslot.

The CCCH LOAD INDication message is sent regularly from BTS to BSC if the load exceeds some value set by O&M. The sending rate is also set by O&M.

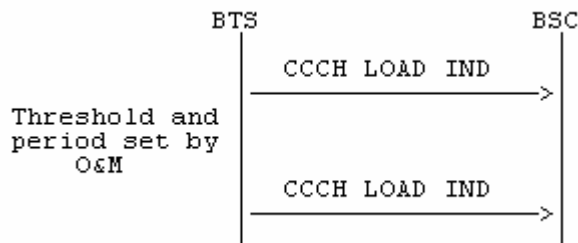

5.5 Broadcast information modify

This procedure is used by BSC to indicate to BTS the new information to be broadcast on BCCH.

For that purpose, BSC sends a BCCH INFO message to BTS.



5.6 Short Message Cell Broadcast

Short Message Service Cell Broadcast messages are sent to BTS as SMS BROADCAST REQUEST or SMS BROADCAST COMMAND messages.

With the SMS BROADCAST REQUEST mode of operation, the BSC handles the queuing, repetition and transmission of the messages taking the capacity of the CBCHs (basic and extended channel (see 3GPP TS 45.002)) into account. The BSC is also responsible for the segmentation of the SMS Cell Broadcast messages on the Radio interface:

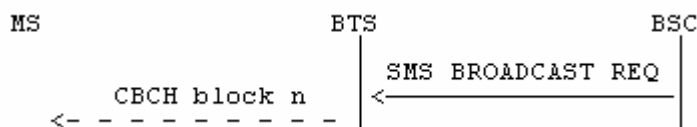

With the SMS BROADCAST COMMAND mode of operation, the BSC can request the broadcast of a complete Cell Broadcast message. The BSC handles the queuing, repetition and transmission of the messages taking the capacity of the CBCHs (basic and extended channel [see 3GPP TS 45.002]) into account. The BSC is responsible for the segmentation of the SMS Cell Broadcast messages on the Radio interface:

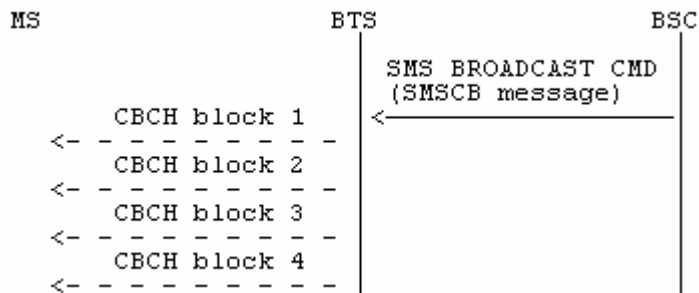

With the SMS BROADCAST COMMAND mode of operation, the BSC can also set the BTS broadcast default mode. The BTS is then responsible for transmission of a default message when no other message is to be broadcast.

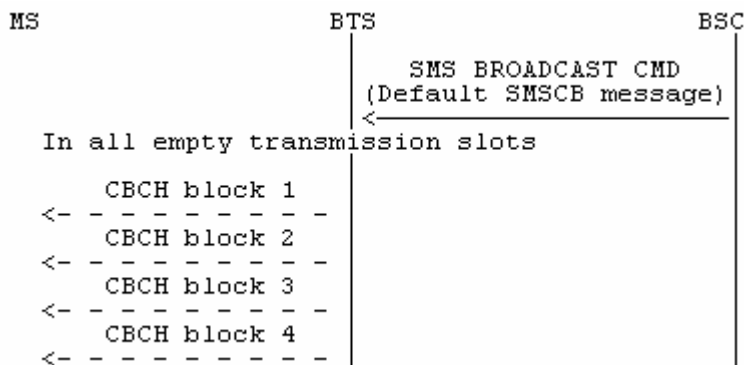

Even though BSC handles the transmission of messages taking the capacity of CBCH into account, BTS can indicate to BSC if an overflow or underflow situation is about to happen in the CBCH. With the CBCH LOAD INDICATION mode of operation, the BTS can request immediate broadcast of m (=amount indicated in the CBCH Load Information element) scheduled SMSCB messages in the underflow situation. BSC shall transmit m scheduled messages and after that continue the broadcast of messages according to its own timetable. If BTS requests more messages than BSC is possessing, then BSC shall transmit only the amount it is possessing. CBCH LOAD INDICATION mode of operation could only be applied when DRX mode is used (see 3GPP TS 44.012).

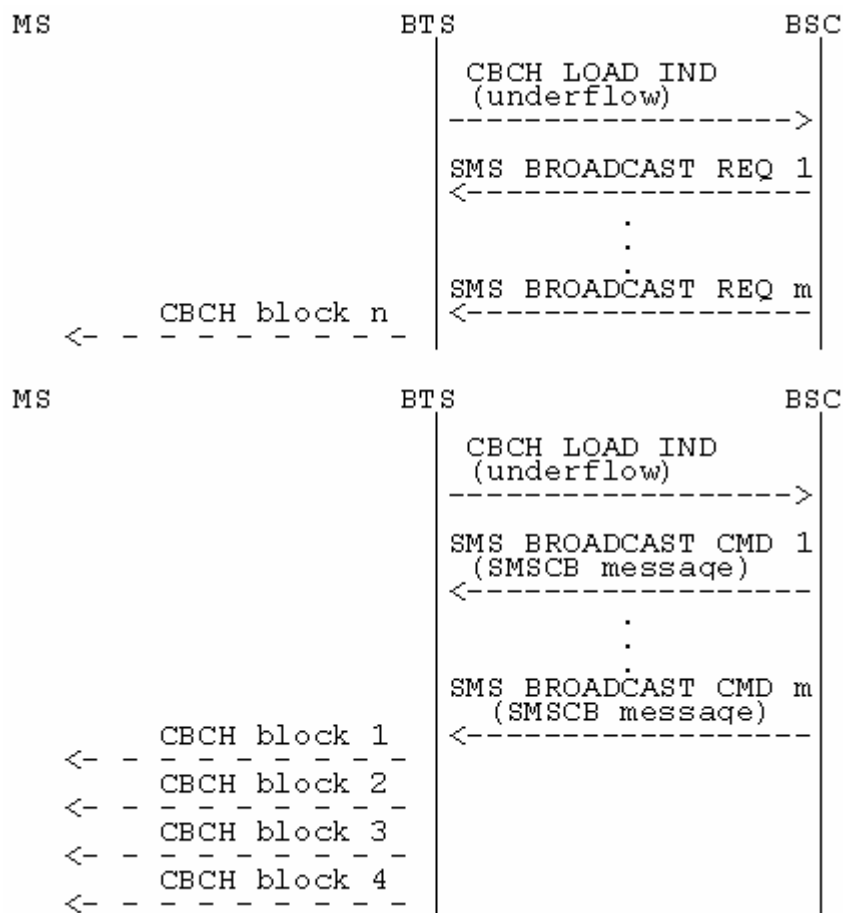

With the CBCH LOAD INDICATION mode of operation, the BTS can also request immediate stop of broadcast for a period of m (=amount indicated in the CBCH Load Information element) message slots in the overflow situation. BSC shall stop the broadcast for a period of m message slots and after that continue the broadcast of messages according to its own timetable.

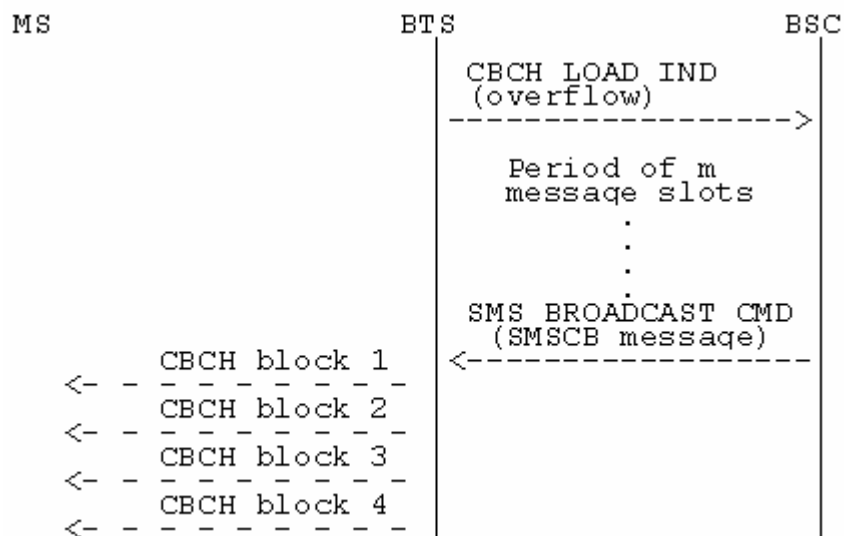
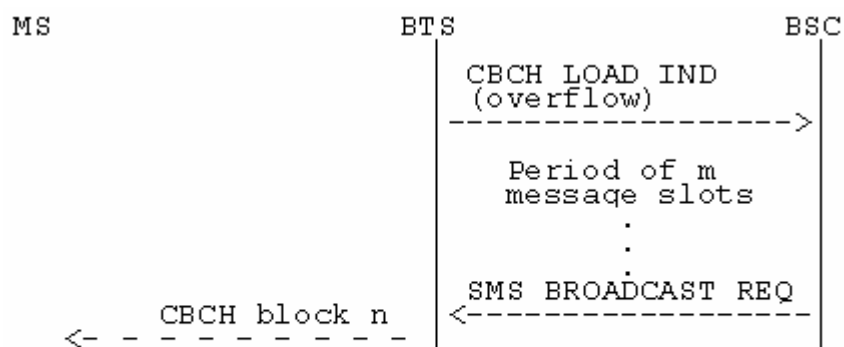

5.7 IMMEDIATE ASSIGNMENT

This procedure is used by BSC to request the transmission of an immediate assign message on downlink CCCH. To initiate the immediate assign, the BSC sends an IMMEDIATE ASSIGN COMMAND message. The message contains the complete immediate assign message as defined in 3GPP TS 44.018 (IMMEDIATE ASSIGNMENT or IMMEDIATE ASSIGNMENT EXTENDED or IMMEDIATE ASSIGNMENT REJECT) with the "Page Mode" element set to the value "no change". Upon receipt of the message, the BTS may transmit the immediate assignment message as received or combine several to construct the IMMEDIATE ASSIGNMENT EXTENDED or IMMEDIATE ASSIGNMENT REJECT. The BTS may also update the "Page Mode" element before transmission.

The IMMEDIATE ASSIGNMENT EXTENDED message is either sent by the BSC in the IMMEDIATE ASSIGN COMMAND, or built by the BTS from up to two IMMEDIATE ASSIGN COMMAND messages.

The IMMEDIATE ASSIGNMENT REJECT message is either sent by the BTS as received in the IMMEDIATE ASSIGN COMMAND message or built by the BTS from the contents of two or more IMMEDIATE ASSIGN COMMAND messages. For the latter case the BTS may consider request references with identical contents within the same message as duplicates and all but one may be suppressed.

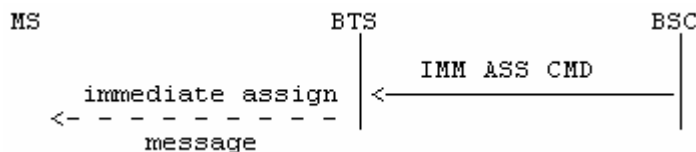

5.8 Notification

This procedure is used to request that notification be performed by the BTS. The BSC indicates the exact action required by the BTS in the command indicator.

The NOTIFICATION messages to be sent on the radio path are built and sent by BTS.

The BSC manages the NCH DRX information whilst the BTS manages the scheduling of the messages on the NCH.

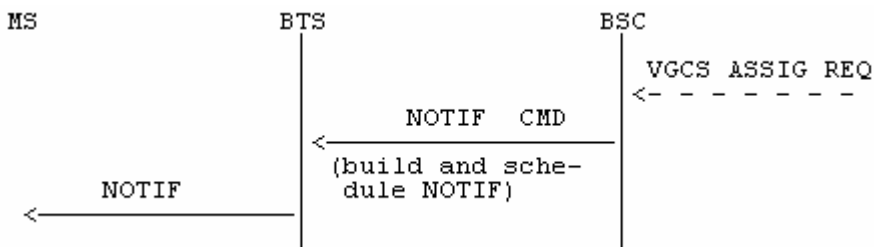

If the BTS for some reason can not perform the notification commanded by the BSC, then the BTS shall return an ERROR REPORT message with the relevant cause value.

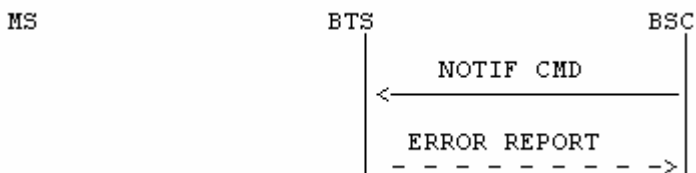

6 TRX management procedures

6.1 Radio resource indication

This procedure is used to inform BSC on the interference levels on idle channels of a TRX.

In the RF RESOURCE INDICATION message, TRX reports the interference level for each of the channels which have been idle (not active) for the whole measurement period. See also 3GPP TS 48.008 and 3GPP TS 45.008.

The RF RESOURCE INDICATION message is sent regularly with a rate set by O&M.

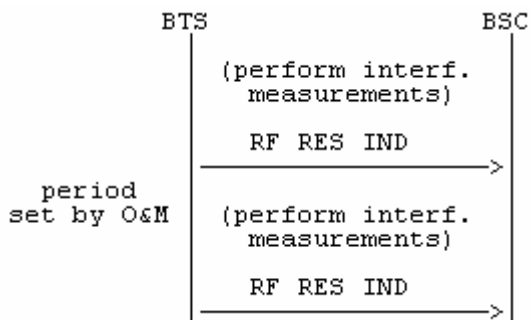

6.2 SACCH filling information modify

This procedure is used by BSC to indicate to BTS the new information to be used as filling information on SACCHs.

For that propose BSC sends a SACCH FILLing message to BTS.

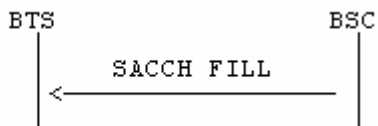

6.3 Flow control

This procedure is defined to give some degree of flow control. It can be used for TRX processor overload, downlink CCCH overload and ACCH overload.

The algorithm used in BSC to control the traffic flow is as follows:

Upon receipt of the first OVERLOAD message, BSC reduces the traffic by one step and starts timers T1 and T2. During T1 all OVERLOAD messages are ignored in order not to reduce the traffic too rapidly. Reception of an OVERLOAD message after T1 but still during T2 will decrease the traffic by one more step and timers T1 and T2 are restarted. This step by step reduction of traffic is continued until maximum reduction is obtained.

If T2 expires (i.e. no OVERLOAD message was received during T2), the traffic will be increased by one step and T2 restarted. This step by step increase of traffic will be continued until full load has been resumed.

The number of steps and the method of reducing the load is considered to be implementation dependent. For example, the amount of random accesses and thereby access grants can be reduced by use of the RACH Control parameters (e.g. Access Control Class or Cell Barred) or the Cell Selection parameters (e.g. CELL-RESELECT-HYSTERESIS or RXLEV- ACCESS-MIN) in the system information messages of 3GPP TS 44.018.

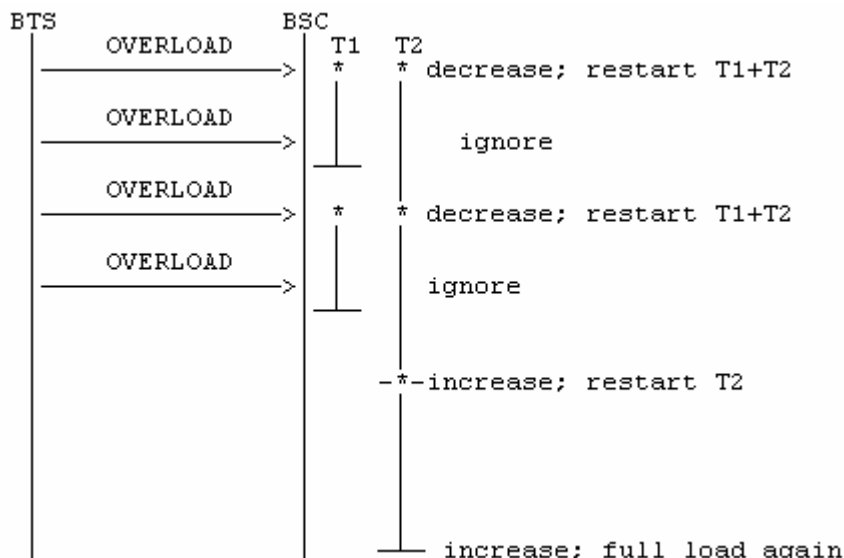

6.4 Error reporting

This procedure is used by BTS to report detected errors as described in clause 7 below if they cannot be reported by any other procedure.

When TRX detects the reception of an erroneous message, it sends an ERROR REPORT message to BSC with the most appropriate cause value. In order to identify the erroneous message, the Message Type, the Channel Number, the Link Identifier and/or the complete erroneous message can be included.



6a Location services procedures

These procedures are related to Location Services (LCS).

6a.1 LLP message transport

This procedure is used to convey LLP messages between the BTS-or Standalone Type B LMU and the BSC, as defined in the Location Services (LCS) Stage 2 document 3GPP TS 23.071.

The sending entity (BSC, Standalone Type B LMU or BTS) sends a Location Information message containing an embedded LLP message to the receiving entity (BSC, Standalone Type B LMU or BTS).

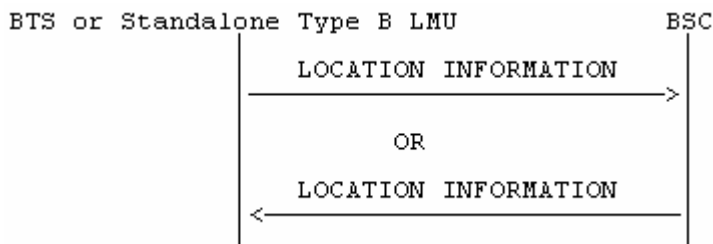

7 Error handling

7.1 General

The procedures specified above apply to those messages which pass the checks described below.

The behaviour of BSC in erroneous cases is implementation dependent.

The behaviour of BTS in erroneous cases is to ignore the message and to send a report to BSC. The report can be sent in either of the following messages:

- CHANNEL ACTIVATION NACK in connection with channel activations;
- MODE MODIFY NACK in connection with a channel mode change;
- ERROR REPORT in other cases.

For procedures controlled by the BSC, and in particular procedures where the BSC sends a request for resources at the BTS and waits for an acknowledge, the implementation in the BSC must provide means for avoiding deadlock situations at the BTS as e.g. hanging resources.

7.2 Message discriminator error

A message with a non-specified message discriminator is erroneous.

7.3 Message type error

A message with a non-specified message type is considered correct, but is ignored by BTS.

7.4 Message sequence error

A message with an existing message type which is not possible according to the specification and to the state of the BTS is erroneous.

7.5 General information element errors

This category includes:

- Information element out of sequence;
- Abnormally duplicated element;
- Missing element.

A message with such an error is erroneous.

7.6 Mandatory information element errors

This includes:

- a) Non-existing element type.
- b) Information length error.
- c) Content which does not comply with the specification (value reserved for future use is considered as case d)).
- d) Value indicated as reserved for future use.

- e) Bits reserved for future use not set to 0.
- f) Content complying with specification but incompatible with the state.
- g) Content complying with the specification but inconsistent.

All cases except e) are considered erroneous.

In case e), BTS simply ignores the reserved (RFU) bits.

7.7 Optional information element errors

The same categories of errors as in previous sub-clause apply.

In cases other than b), e), f) and g), BTS ignores the element and processes the rest of the message.

Cases b), f) and g) are considered erroneous.

In case e), BTS ignores the reserved (RFU) bits.

7.8 Conditional information element errors

The same categories of errors as in sub-clause 7.6 apply.

If the conditions for presence of the element are met, the same erroneous cases as in sub-clause 7.6 apply.

If the conditions for presence of the element are not met, the same erroneous cases as in sub-clause 7.7 apply.

8 Message formats and contents

8.0 General

This sub-clause defines the format and contents of the messages sent over the A-bis interface. Similar coding principles as in 3GPP TS 24.008 and 3GPP TS 48.008 are used.

For each message, the contained Information Elements are listed. For each Information Element, the following information is given:

- Name of Information Element;
- Reference sub-clause for the coding of the Information Element;
- Presence condition for the Information Element;
 - M Mandatory, must always be present;
 - receiver:** if not present, consider message erroneous;
 - C Conditional, presence depending on e.g.
 - a) value of other element;
 - b) presence of optional element;
 - receiver:** if not present when condition met, consider message erroneous, else accept message;
 - O Optional, **receiver:** present or not, accept message;
- Format of Information Element:

- T Type only, fixed length, only Element Identifier;
- V Value only, fixed length, no Element Identifier included;
- TV Type and Value, fixed length, Element Identifier included;
- TLV Type, Length and Value, variable length, Element Identifier and Length Indicator included;

- Total length of Information Element; for variable length, lower and upper limits.

NOTE: Maximum message length is determined by the N201 parameter of 3GPP TS 48.056.

In a message, the message discriminator is transmitted first. The purpose is to distinguish between transparent messages (T-bit set to 1) and non-transparent messages (T-bit set to 0) and also between messages related to Radio Link Layer Management, Dedicated Channel Management, Common Channel Management and TRX Management. The octets are sent in the order shown in the description of the messages and information elements.

8.1 Transparent messages

Transparent messages are used at the A-bis interface to convey layer 3 messages for the radio interface as defined in 3GPP TS 44.018 and for which BTS has to take or has taken no specific action. The T- bit of the Message Discriminator is set to 1.

In the uplink direction (messages from MS), all messages received in I- frames and all messages received in UI-frames except for the MEASurement REPort message are considered as transparent. They are forwarded to BSC as DATA INDication and UNIT DATA INDication messages respectively.

In the downlink direction (messages to MS) all messages as defined in 3GPP TS 44.018 are transparent except for the following messages, which are replaced by BSC-BTS specific messages over the A- bis interface and where BTS will send the corresponding L3 message over the radio interface after the necessary actions have been taken:

Message to MS	Replaced on A-bis interface by
CIPHering MODe CoMmanD	ENCRyption CoMmanD
PAGing REQuest	PAGing CoMmanD
NOTIFication	NOTIFication CoMmanD
SYSTEM INFOrmation	BCCH INFOrmation and SACCH FILLing
EXTENDED MEASUREMENT ORDER	SACCH FILLing
Immediate assign (3 types)	IMMEDIATE ASSIGN COMMAND

Transparent messages are sent by BSC as DATA REQuest or UNIT DATA REQuest messages.

8.2 Non-transparent messages (BSC-BTS specific messages)

These messages are used over the A-bis interface for messages on which BTS has to take some action (BSC to BTS direction) and for messages which are the result from actions taken by BTS (BTS to BSC direction). The T-bit of the Message Discriminator is set to 0.

8.3 Radio link layer management messages

These messages are related to Radio Link Layer Management procedures. They all have the following general format:

INFORMATION ELEMENT	REFERENCE	PRESENCE	FORMAT	LENGTH
Message discriminator	9.1	M	V	1
Message type	9.2	M	V	1
Channel number	9.3.1	M	TV	2
Link Identifier	9.3.2	M	TV	2
(Information elements depending on message type)				

The messages concerned are the following:

Message name	Reference sub-clause
DATA REQuest	8.3.1
DATA INDication	8.3.2
ERROR INDication	8.3.3
ESTablish REQuest	8.3.4
ESTablish CONFirm	8.3.5
ESTablish INDication	8.3.6
RELease REQuest	8.3.7
RELease CONFirm	8.3.8
RELease INDication	8.3.9
UNIT DATA REQuest	8.3.10
UNIT DATA INDication	8.3.11

8.3.1 DATA REQUEST

This message is sent from BSC to BTS to request the sending of a message in acknowledged mode on a radio link layer connection.

INFORMATION ELEMENT	REFERENCE	PRESENCE	FORMAT	LENGTH
Message discriminator	9.1	M	V	1
Message type	9.2	M	V	1
Channel number	9.3.1	M	TV	2
Link Identifier	9.3.2	M	TV	2
L3 Information	9.3.11	M	TLV	>=3

8.3.2 DATA INDICATION

This message is sent from BTS to BSC to indicate the reception of a message in acknowledged mode on a radio link layer connection.

INFORMATION ELEMENT	REFERENCE	PRESENCE	FORMAT	LENGTH
Message discriminator	9.1	M	V	1
Message type	9.2	M	V	1
Channel number	9.3.1	M	TV	2
Link Identifier	9.3.2	M	TV	2
L3 Information	9.3.11	M	TLV	>=3

8.3.3 ERROR INDICATION

This message is sent from BTS to BSC to indicate an abnormal case for a radio link layer connection.

INFORMATION ELEMENT	REFERENCE	PRESENCE	FORMAT	LENGTH
Message discriminator	9.1	M	V	1
Message type	9.2	M	V	1
Channel number	9.3.1	M	TV	2
Link Identifier	9.3.2	M	TV	2
RLM Cause	9.3.22	M	TLV	2-4

8.3.4 ESTABLISH REQUEST

This message is sent from BSC to BTS to request the establishment of a multi-frame mode (acknowledged mode) link layer connection on the radio path.

INFORMATION ELEMENT	REFERENCE	PRESENCE	FORMAT	LENGTH
Message discriminator	9.1	M	V	1
Message type	9.2	M	V	1
Channel number	9.3.1	M	TV	2
Link Identifier	9.3.2	M	TV	2

8.3.5 ESTABLISH CONFIRM

This message is sent from BTS to BSC to confirm the establishment of a radio link layer connection in multi-frame (acknowledged) mode.

INFORMATION ELEMENT	REFERENCE	PRESENCE	FORMAT	LENGTH
Message discriminator	9.1	M	V	1
Message type	9.2	M	V	1
Channel number	9.3.1	M	TV	2
Link Identifier	9.3.2	M	TV	2

8.3.6 ESTABLISH INDICATION

This message is sent from BTS to BSC to indicate the establishment of a radio link layer connection in multi-frame mode, initiated by an MS.

INFORMATION ELEMENT	REFERENCE	PRESENCE	FORMAT	LENGTH
Message discriminator	9.1	M	V	1
Message type	9.2	M	V	1
Channel number	9.3.1	M	TV	2
Link Identifier	9.3.2	M	TV	2
L3 Information	9.3.11	O (note 1)	TLV	3-23
NOTE 1: The L3 Information field is present only if the SABM frame contained a non-empty information field				

NOTE: The "establish mode" parameter appearing in 3GPP TS 44.006 is used only on the MS side.

8.3.7 RELEASE REQUEST

This message is sent from BSC to BTS to request the release of multi-frame mode of a radio link layer connection.

INFORMATION ELEMENT	REFERENCE	PRESENCE	FORMAT	LENGTH
Message discriminator	9.1	M	V	1
Message type	9.2	M	V	1
Channel number	9.3.1	M	TV	2
Link Identifier	9.3.2	M	TV	2
Release Mode	9.3.20	M	TV	2

8.3.8 RELEASE CONFIRM

This message is sent from BTS to BSC to confirm the release of multi-frame mode of a radio link layer connection.

INFORMATION ELEMENT	REFERENCE	PRESENCE	FORMAT	LENGTH
Message discriminator	9.1	M	V	1
Message type	9.2	M	V	1
Channel number	9.3.1	M	TV	2
Link Identifier	9.3.2	M	TV	2

8.3.9 RELEASE INDICATION

This message is sent from BTS to BSC to indicate the release of a radio link layer connection (initiated by MS).

INFORMATION ELEMENT	REFERENCE	PRESENCE	FORMAT	LENGTH
Message discriminator	9.1	M	V	1
Message type	9.2	M	V	1
Channel number	9.3.1	M	TV	2
Link Identifier	9.3.2	M	TV	2

8.3.10 UNIT DATA REQUEST

This message is sent from BSC to BTS to request the sending of a message in unacknowledged mode on a radio link layer connection.

INFORMATION ELEMENT	REFERENCE	PRESENCE	FORMAT	LENGTH
Message discriminator	9.1	M	V	1
Message type	9.2	M	V	1
Channel number	9.3.1	M	TV	2
Link Identifier	9.3.2	M	TV	2
L3 Information	9.3.11	M	TLV	3-25

8.3.11 UNIT DATA INDICATION

This message is sent from BTS to BSC to indicate the reception of a message in unacknowledged mode on a radio link layer connection.

INFORMATION ELEMENT	REFERENCE	PRESENCE	FORMAT	LENGTH
Message discriminator	9.1	M	V	1
Message type	9.2	M	V	1
Channel number	9.3.1	M	TV	2
Link Identifier	9.3.2	M	TV	2
L3 Information	9.3.11	M	TLV	3-23

8.4 DEDICATED CHANNEL MANAGEMENT MESSAGES

These messages are related to Dedicated Channel Management procedures. They all have the following general format:

INFORMATION ELEMENT	REFERENCE	PRESENCE	FORMAT	LENGTH
Message discriminator	9.1	M	V	1
Message type	9.2	M	V	1
Channel number	9.3.1	M	TV	2
(Information elements depending on message type)				

The messages concerned are the following:

Message name	Reference sub-clause
CHANnel ACTIVation	8.4.1
CHANnel ACTIVation ACKnowledge	8.4.2
CHANnel ACTIVation Negative ACK	8.4.3
CONNection FAILure INDication	8.4.4
DEACTIVATE SACCH	8.4.5
ENCRyption CoMmanD	8.4.6
HANDOver DETection	8.4.7
TALKER DETection	8.4.21
LISTENER DETection	8.4.22
MEASurement RESult	8.4.8
MODE MODIFY REQuest	8.4.9
MODE MODIFY ACKnowledge	8.4.10
MODE MODIFY Negative ACKnowledge	8.4.11
PHYSical CONTEXT REQuest	8.4.12
PHYSical CONTEXT CONFirm	8.4.13
RF CHANnel RELease	8.4.14
MS POWER CONTROL	8.4.15
BS POWER CONTROL	8.4.16
PREPROCecc CONFIGure	8.4.17
PREPROCecced MEASurement RESult	8.4.18
RF CHANnel RELease ACKnowledge	8.4.19
SACCH INFO MODIFY	8.4.20
REMOTE CODEC CONFiguration REPort	8.4.23
Round Trip Delay REPort	8.4.24
PRE-HANDOver NOTIFication	8.4.25
MultiRate CODEC MODification REQuest	8.4.26
MultiRate CODEC MOD ACKnowledge	8.4.27
MultiRate CODEC MOD Negative ACK	8.4.28
MultiRate CODEC MOD PERformed	8.4.29
TFO REPort	8.4.30
TFO MODification REQuest	8.4.31

8.4.1 CHANNEL ACTIVATION

This message is sent from BSC to BTS in order to activate a radio channel. The attributes of the channel are defined in the message.

INFORMATION ELEMENT	REFERENCE	PRESENCE	FORMAT	LENGTH
Message discriminator	9.1	M	V	1
Message type	9.2	M	V	1
Channel number	9.3.1	M	TV	2
Activation Type	9.3.3	M	TV	2
Channel Mode	9.3.6	M	TLV	8-9
Channel Identification	9.3.5	O 7)	TLV	8
Encryption information	9.3.7	O 1)	TLV	>=3
Handover Reference	9.3.9	C 2)	TV	2
BS Power	9.3.4	O 3)	TV	2
MS Power	9.3.13	O 3)	TV	2
Timing Advance	9.3.24	C 3) 4)	TV	2
BS Power Parameters	9.3.32	O 5)	TLV	>=2
MS Power Parameters	9.3.31	O 5)	TLV	>=2
Physical Context	9.3.16	O 6)	TLV	>=2
SACCH Information	9.3.29	O 8)	TLV	>=3
UIC	9.3.50	O 9)	TLV	3
Main channel reference	9.3.51	O 10)	TV	2
MultiRate configuration	9.3.52	O 11)	TLV	>=4
MultiRate Control	9.3.53	O 12)	TV	2
Supported Codec Types	9.3.54	O 12)	TLV	>=5
TFO transparent container	9.3.59	O 12)	TLV	>=3

- 1) The Encryption Information element is only included if ciphering is to be applied.
- 2) The Handover Reference element is only included if activation type is handover.
- 3) If BS Power, MS Power and/or Timing Advance elements are present, they are to be used to set the initial transmission power and the initial L1-header.
- 4) The Timing Advance element must be included if activation type is intra cell channel change.
- 5) The BS and MS Power Parameters elements are included to indicate that BS and/or MS power control is to be performed by BTS. The maximum power to be used is indicated in the BS and MS Power elements respectively.
- 6) Optional element for additional physical channel information.
- 7) Included if compatibility with phase1 is required.
- 8) Optional element for setting the SACCH filling information individually for this channel. If this element is present, the SACCH filling information as given by this element shall be used for this channel (replacing any SACCH filling information as given by the SACCH FILLING message(s)) until the channel is released or the information is changed by a SACCH INFO MODIFY message. (If this element is not present, the SACCH filling as given by the SACCH FILLING message(s) shall be used.)
- 9) The UIC element may be included for voice group calls. It is used in the same way as the BSIC for decoding the random access bursts when decoding uplink access bursts. If not included, the BSIC shall be used for decoding uplink access bursts.
- 10) Optional element for multislot operation, it may be used in case of power control in the BTS.
- 11) Included if the Channel Mode indicates that a multi-rate speech codec is used.
- 12) Optionally included if the Channel Mode indicates that a multi-rate speech codec is used and TFO control is required or to give to the BTS the possibility to change autonomously the multi-rate codec configuration.

8.4.2 CHANNEL ACTIVATION ACKNOWLEDGE

This message is sent from BSC to BTS to acknowledge that the requested channel activation has been completed correctly.

INFORMATION ELEMENT	REFERENCE	PRESENCE	FORMAT	LENGTH
Message discriminator	9.1	M	V	1
Message type	9.2	M	V	1
Channel number	9.3.1	M	TV	2
Frame number	9.3.8	M	TV	3

The Frame Number element is used by BSC to calculate the Starting Time parameter when required.

8.4.3 CHANNEL ACTIVATION NEGATIVE ACKNOWLEDGE

This message is sent from BTS to BSC to indicate that the channel activation could not be performed as requested.

INFORMATION ELEMENT	REFERENCE	PRESENCE	FORMAT	LENGTH
Message discriminator	9.1	M	V	1
Message type	9.2	M	V	1
Channel number	9.3.1	M	TV	2
Cause	9.3.26	M	TLV	>=3

If the Channel Activation message was received with an erroneous Channel number information element, the Channel Activation Negative Acknowledge message is returned with the Channel Number information element equal to the received (and erroneous) Channel number and the Cause value "Mandatory Information Element Error" with Diagnostics equal to the Channel number element identifier value.

8.4.4 CONNECTION FAILURE INDICATION

This message is sent from BTS to BSC to indicate that an active connection has been broken for some reason.

INFORMATION ELEMENT	REFERENCE	PRESENCE	FORMAT	LENGTH
Message discriminator	9.1	M	V	1
Message type	9.2	M	V	1
Channel number	9.3.1	M	TV	2
Cause	9.3.26	M	TLV	>=3

8.4.5 DEACTIVATE SACCH

This message is sent from BSC to BTS in order to deactivate the SACCH of an active channel.

INFORMATION ELEMENT	REFERENCE	PRESENCE	FORMAT	LENGTH
Message discriminator	9.1	M	V	1
Message type	9.2	M	V	1
Channel number	9.3.1	M	TV	2

8.4.6 ENCRYPTION COMMAND

This message is sent from BSC to BTS to start ciphering mode operation.

INFORMATION ELEMENT	REFERENCE	PRESENCE	FORMAT	LENGTH
Message discriminator	9.1	M	V	1
Message type	9.2	M	V	1
Channel number	9.3.1	M	TV	2
Encryption information	9.3.7	M	TLV	>=3
Link Identifier	9.3.2	M	TV	2
L3 Info (CIPH MOD CMD)	9.3.11	M	TLV	6

The L3 Info element contains the complete Ciphering Mode Command message as defined in 3GPP TS 44.018.

8.4.7 HANDOVER DETECTION

This message is sent from BTS to BSC when BTS correctly receives information from an MS on the handover activated channel.

INFORMATION ELEMENT	REFERENCE	PRESENCE	FORMAT	LENGTH
Message discriminator	9.1	M	V	1
Message type	9.2	M	V	1
Channel number	9.3.1	M	TV	2
Access Delay	9.3.17	O 1)	TV	2

- 1) The Access Delay element is included if the sending of the handover detection message was triggered by the reception of a handover access burst with the correct handover reference.

8.4.8 MEASUREMENT RESULT

This message from BTS to BSC is used to report to BSC the results of radio channel measurements made by BTS (uplink) and to convey the measurement reports from MS received on SACCH and in the L1 headers.

INFORMATION ELEMENT	REFERENCE	PRESENCE	FORMAT	LENGTH
Message discriminator	9.1	M	V	1
Message type	9.2	M	V	1
Channel number	9.3.1	M	TV	2
Measurement result number	9.3.27	M	TV	2
Uplink Measurements	9.3.25	M	TLV	>=5
BS Power	9.3.4	M	TV	2
L1 Information	9.3.10	O 1)	TV	3
L3 Info (MEAS REP, EXT MEAS REP or ENH MEAS REP)	9.3.11	O 1)	TLV	21
MS Timing Offset	9.3.37	O 2)	TV	2

- 1) The L1 Information element contains the last received L1-header (MS Power and Timing Advance) from MS and the L3 Information element contains the complete MEASurement REPort message EXTended MEASurement REPort message or ENHanced MEASurement REPort message received from MS. They are included only if received since last (EXTended/ENHanced) MEASurement RESult message.
- 2) MS Timing Offset can be optionally included to increase the accuracy of possible distance measurements.

8.4.9 MODE MODIFY

This message is sent from BSC to BTS to request a change of channel mode of an active channel.

INFORMATION ELEMENT	REFERENCE	PRESENCE	FORMAT	LENGTH
Message discriminator	9.1	M	V	1
Message type	9.2	M	V	1
Channel number	9.3.1	M	TV	2
Channel Mode	9.3.6	M	TLV	8-9
Encryption information	9.3.7	O 1)	TLV	>=3
Main channel reference	9.3.45	O 2)	TV	2
MultiRate configuration	9.3.52	O 3)	TLV	>=3
Multirate Control	9.3.53	O 4)	TV	2
Supported Codec Types	9.3.54	O 4)	TLV	>=5
TFO transparent container	9.3.59	O 4)	TLV	>=3

- 1) The Encryption Information element is only included if ciphering is to be applied.
- 2) Optional element for multislot operation, it may be used in case of power control in the BTS.
- 3) Included if the Channel Mode indicates that a multi-rate speech codec is used.
- 4) Optionally included if the Channel Mode indicates that a multi-rate speech codec is used and TFO control is required or to give to the BTS the possibility to change autonomously the multi-rate codec configuration.

8.4.10 MODE MODIFY ACKNOWLEDGE

This message is sent from BTS to BSC to confirm the change of channel mode of an active channel.

INFORMATION ELEMENT	REFERENCE	PRESENCE	FORMAT	LENGTH
Message discriminator	9.1	M	V	1
Message type	9.2	M	V	1
Channel number	9.3.1	M	TV	2

8.4.11 MODE MODIFY NEGATIVE ACKNOWLEDGE

This message is sent from BTS to BSC to indicate that the channel mode modification could not be performed as requested.

INFORMATION ELEMENT	REFERENCE	PRESENCE	FORMAT	LENGTH
Message discriminator	9.1	M	V	1
Message type	9.2	M	V	1
Channel number	9.3.1	M	TV	2
Cause	9.3.26	M	TLV	>=3

8.4.12 PHYSICAL CONTEXT REQUEST

This message is sent from BSC to BTS to request the "physical context" of an active channel.

INFORMATION ELEMENT	REFERENCE	PRESENCE	FORMAT	LENGTH
Message discriminator	9.1	M	V	1
Message type	9.2	M	V	1
Channel number	9.3.1	M	TV	2

8.4.13 PHYSICAL CONTEXT CONFIRM

This message is sent from BTS to BSC as a response to a PHYSICAL CONTEXT REQUEST message. The message contains the "physical context" information.

INFORMATION ELEMENT	REFERENCE	PRESENCE	FORMAT	LENGTH
Message discriminator	9.1	M	V	1
Message type	9.2	M	V	1
Channel number	9.3.1	M	TV	2
BS Power	9.3.4	M	TV	2
MS Power	9.3.13	M	TV	2
Timing Advance	9.3.24	M	TV	2
Physical Context	9.3.16	O 1)	TLV	>=2

- 1) Optional element for additional physical channel information.

8.4.14 RF CHANNEL RELEASE

This message is sent from BSC to BTS to inform that a radio channel is no longer needed.

INFORMATION ELEMENT	REFERENCE	PRESENCE	FORMAT	LENGTH
Message discriminator	9.1	M	V	1
Message type	9.2	M	V	1
Channel number	9.3.1	M	TV	2

8.4.15 MS POWER CONTROL

This message is sent from BSC to BTS to change the MS power level or the parameters used by TRX to control the MS power.

INFORMATION ELEMENT	REFERENCE	PRESENCE	FORMAT	LENGTH
Message discriminator	9.1	M	V	1
Message type	9.2	M	V	1
Channel number	9.3.1	M	TV	2
MS Power	9.3.13	M	TV	2
MS Power Parameters	9.3.31	O 1)	TLV	>=2

- 1) If the MS Power Parameters element is present it indicates that the MS power control is to be performed by TRX. The MS Power element then indicates the maximum MS power to be used.

8.4.16 BS POWER CONTROL

This message is sent from BSC to BTS to change the TRX transmission power level or the parameters used by TRX to control its transmission power.

INFORMATION ELEMENT	REFERENCE	PRESENCE	FORMAT	LENGTH
Message discriminator	9.1	M	V	1
Message type	9.2	M	V	1
Channel number	9.3.1	M	TV	2
BS Power	9.3.4	M	TV	2
BS Power Parameters	9.3.32	O 1)	TLV	>=2

- 1) If the BS Power Parameters element is present it indicates that the TRX transmission power control is to be performed by TRX. The BS Power element then indicates the maximum transmission power to be used.

8.4.17 PREPROCESS CONFIGURE

This message is sent from BSC to BTS to modify the pre-processing parameters used by BTS.

INFORMATION ELEMENT	REFERENCE	PRESENCE	FORMAT	LENGTH
Message discriminator	9.1	M	V	1
Message type	9.2	M	V	1
Channel number	9.3.1	M	TV	2
Preproc. Parameters	9.3.33	M	TLV	>=3

8.4.18 PREPROCESSED MEASUREMENT RESULT

This message is used by BTS to report the results of radio parameter pre-processing.

INFORMATION ELEMENT	REFERENCE	PRESENCE	FORMAT	LENGTH
Message discriminator	9.1	M	V	1
Message type	9.2	M	V	1
Channel number	9.3.1	M	TV	2
Preproc. Measurements	9.3.34	M	TLV	>=2

8.4.19 RF CHANNEL RELEASE ACKNOWLEDGE

This message is sent from BTS to BSC as an acknowledge to a RF CHANnel RELease message.

INFORMATION ELEMENT	REFERENCE	PRESENCE	FORMAT	LENGTH
Message discriminator	9.1	M	V	1
Message type	9.2	M	V	1
Channel number	9.3.1	M	TV	2

8.4.20 SACCH INFO MODIFY

This message is sent from BSC to BTS to modify the SACCH filling information sent on an individual SACCH channel. This new SACCH filling information shall be sent on the indicated channel until the channel is released or the information is changed by another SACCH INFO MODIFY message.

INFORMATION ELEMENT	REFERENCE	PRESENCE	FORMAT	LENGTH
Message discriminator	9.1	M	V	1
Message type	9.2	M	V	1
Channel number	9.3.1	M	TV	2
System Info Type	9.3.30	M	TV	2
L3 Info	9.3.11	O 1)	TLV	22
Starting Time	9.3.23	O 2)	TV	3

- 1) If the L3 Info information element is not included, this indicates that transmission of the indicated message shall be stopped, i.e. message shall no longer be sent on this channel.
- 2) The Starting Time element is optionally used to indicate when transmission of the new information is to start and when transmission is to stop.

The System Info Type element indicates the type of SYSTEM INFORMATION/EXTENDED MEASUREMENT ORDER message which follows in the L3 Info field.

The L3 Information element contains the relevant SYSTEM INFORMATION/EXTENDED MEASUREMENT ORDER message as defined in 3GPP TS 44.018.

8.4.21 TALKER DETECTION

This message is sent from BTS to BSC when BTS correctly receives on a channel activated for VGCS an access from an MS indicating that it requires the uplink of the channel.

INFORMATION ELEMENT	REFERENCE	PRESENCE	FORMAT	LENGTH
Message discriminator	9.1	M	V	1
Message type	9.2	M	V	1
Channel number	9.3.1	M	TV	2
Access Delay	9.3.17	O 1)	TV	2

- 1) The Access Delay element is included if the sending of the uplink access message was triggered by the reception of an uplink access burst with the correct values.

8.4.22 LISTENER DETECTION

This message is sent from BTS to BSC when BTS correctly receives on a channel activated for VGCS or VBS an access from an MS indicating its presence on the channel.

INFORMATION ELEMENT	REFERENCE	PRESENCE	FORMAT	LENGTH
Message discriminator	9.1	M	V	1
Message type	9.2	M	V	1
Channel number	9.3.1	M	TV	2
Access Delay	9.3.17	O 1)	TV	2

- 1) The Access Delay element is included if the sending of the uplink access message was triggered by the reception of an uplink access burst with the correct value.

8.4.23 REMOTE CODEC CONFIGURATION REPORT

This message is sent by the BTS to the BSC to report the codec information received from a remote BTS prior to TFO establishment or in TFO.

INFORMATION ELEMENT	REFERENCE	PRESENCE	FORMAT	LENGTH
Message discriminator	9.1	M	V	1
Message type	9.2	M	V	1
Channel number	9.3.1	M	TV	2
Codec Configuration	9.3.55	M	TLV	>=3
Supported Codec Types	9.3.54	M	TLV	>=5
TFO transparent container	9.3.59	O 4)	TLV	>=3

8.4.24 ROUND TRIP DELAY REPORT

This message is sent by the BSC to the BTS to report the computed round trip transmission delay between the BTS and the transcoder or between the BTS and the remote BTS when TFO is established.

INFORMATION ELEMENT	REFERENCE	PRESENCE	FORMAT	LENGTH
Message discriminator	9.1	M	V	1
Message type	9.2	M	V	1
Channel number	9.3.1	M	TV	2
Round Trip Delay	9.3.56	M	TV	2

8.4.25 PRE-HANDOVER NOTIFICATION

This message is sent by the BSC to the serving BTS to notify the BTS that an handover is going to be performed. It is also sent by the BSC to the serving BTS if the announced handover has failed.

INFORMATION ELEMENT	REFERENCE	PRESENCE	FORMAT	LENGTH
Message discriminator	9.1	M	V	1
Message type	9.2	M	V	1
Channel number	9.3.1	M	TV	2
MultiRateControl	9.3.53	M	TV	2
Codec Configuration	9.3.55	M	TLV	>=3
TFO transparent container	9.3.59	O 4)	TLV	>=3

8.4.26 MULTIRATE CODEC MODIFICATION REQUEST

This message is sent by the BSC to the BTS to request and authorise the BTS to change the Multi-Rate codec configuration using inband signalling message exchange.

It is also sent by the BTS to the BSC, in the case where the TC or the BTS runs the TFO algorithm, and the BSC is responsible for changing the codec configuration. In this case, it is not acknowledged by the BSC.

INFORMATION ELEMENT	REFERENCE	PRESENCE	FORMAT	LENGTH
Message discriminator	9.1	M	V	1
Message type	9.2	M	V	1
Channel number	9.3.1	M	TV	2
MultiRate Configuration	9.3.52	O 1)	TLV	>=4

- 1) Not included if the BTS can solve the codec mismatch for TFO establishment

8.4.27 MULTIRATE CODEC MODIFICATION ACKNOWLEDGE

This message is sent by the BTS to the BSC to acknowledge the performed change of the MultiRate Codec configuration, when it was requested by the BSC with the MultiRate CODEC MODification REQuest message

INFORMATION ELEMENT	REFERENCE	PRESENCE	FORMAT	LENGTH
Message discriminator	9.1	M	V	1
Message type	9.2	M	V	1
Channel number	9.3.1	M	TV	2
MultiRate Configuration	9.3.52	O 1)	TLV	>=4

8.4.28 MULTIRATE CODEC MODIFICATION NEGATIVE ACKNOWLEDGE

This message is sent by the BTS to the BSC to report a failure to change the MultiRate Codec Configuration.

INFORMATION ELEMENT	REFERENCE	PRESENCE	FORMAT	LENGTH
Message discriminator	9.1	M	V	1
Message type	9.2	M	V	1
Channel number	9.3.1	M	TV	2
Cause	9.3.26	M	TLV	>=3

8.4.29 MULTIRATE CODEC MODIFICATION PERFORMED

This message is sent by the BTS to the BSC to inform the BSC of a performed change of the MultiRate Codec Configuration in case the BTS is generally authorised to perform this change and has initiated this on its own.

INFORMATION ELEMENT	REFERENCE	PRESENCE	FORMAT	LENGTH
Message discriminator	9.1	M	V	1
Message type	9.2	M	V	1
Channel number	9.3.1	M	TV	2
MultiRate Configuration	9.3.52	M	TLV	>=4

8.4.30 TFO REPORT

This message is sent by the BTS to the BSC to inform the BSC that Tandem Free Operation with AMR is established, or is not established anymore.

INFORMATION ELEMENT	REFERENCE	PRESENCE	FORMAT	LENGTH
Message discriminator	9.1	M	V	1
Message type	9.2	M	V	1
Channel number	9.3.1	M	TV	2
TFO Status	9.3.57	M	TV	1

8.4.31 TFO MODIFICATION REQUEST

This message is sent by the BSC to the BTS to change the configuration of TFO while operating with AMR.

INFORMATION ELEMENT	REFERENCE	PRESENCE	FORMAT	LENGTH
Message discriminator	9.1	M	V	1
Message type	9.2	M	V	1
Channel number	9.3.1	M	TV	2
MultiRateControl	9.3.53	M	TV	2
Supported Codec Type	9.3.54	O 1)	TLV	>=5
TFO transparent container	9.3.59	O 4)	TLV	>=3

- 1) Optionally included if TFO is enabled within I.E. MultiRateControl

8.5 COMMON CHANNEL MANAGEMENT MESSAGES

These messages are related to Common Channel Management procedures. They all have the following general format:

INFORMATION ELEMENT	REFERENCE	PRESENCE	FORMAT	LENGTH
Message discriminator	9.1	M	V	1
Message type	9.2	M	V	1
Channel number	9.3.1	M	TV	2
(Information elements depending on message type)				

The messages concerned are the following:

Message name	Reference sub-clause
BCCH INFOrmation	8.5.1
CCCH LOAD INDication	8.5.2
CHANnel ReQuireD	8.5.3
DELETE INDication	8.5.4
PAGING CoMmanD	8.5.5
NOTification CoMmanD	8.5.10
IMMEDIATE ASSIGN COMMAND	8.5.6
SMS BroadCast REQuest	8.5.7
SMS Broadcast Command	8.5.8
CBCH LOAD INDICATION	8.5.9

8.5.1 BCCH INFORMATION

This message is sent from BSC to BTS to indicate new information to be broadcast on BCCH.

INFORMATION ELEMENT	REFERENCE	PRESENCE	FORMAT	LENGTH
Message discriminator	9.1	M	V	1
Message type	9.2	M	V	1
Channel number	9.3.1	M	TV	2
System Info Type	9.3.30	M	TV	2
Full BCCH Info (SYS INFO)	9.3.39	O 1)	TLV	25
Starting Time	9.3.23	O 2)	TV	3

- 1) If the Full BCCH information element is not included this indicates that transmission of the indicated SYSTEM INFORMATION message shall be stopped.
- 2) The Starting Time element is optionally used to indicate when transmission of the new information is to start or when transmission is to stop.

The System Info Type element indicates the type of SYSTEM INFORMATION message which follows in the Full BCCH Information element.

The Full BCCH Information element contains the relevant SYSTEM INFORMATION message as defined in 3GPP TS 44.018.

8.5.2 CCCH LOAD INDICATION

This message is sent from BTS to BSC to report the current load on the indicated CCCH timeslot (random access, RACH, and paging, PCH).

INFORMATION ELEMENT	REFERENCE	PRESENCE	FORMAT	LENGTH
Message discriminator	9.1	M	V	1
Message type	9.2	M	V	1
Channel number (note)	9.3.1	M	TV	2
RACH Load	9.3.18	C 1)	TLV	>=8
Paging Load	9.3.15	C 2)	TV	3

NOTE: The BTS may set the "Channel Number" information element in this message to either the "uplink CCCH" or the "downlink CCCH" on that timeslot number.

- 1) The RACH load information element is included only if the Channel number information indicates "uplink CCCH".
- 2) The Paging load information element is included only if the Channel number information indicates "downlink CCCH".

8.5.3 CHANNEL REQUIRED

This message is sent from BTS to BSC to indicate the reception of a CHANnel REQuest message (special access burst message) from an MS.

INFORMATION ELEMENT	REFERENCE	PRESENCE	FORMAT	LENGTH
Message discriminator	9.1	M	V	1
Message type	9.2	M	V	1
Channel number	9.3.1	M	TV	2
Request Reference	9.3.19	M	TV	4
Access Delay	9.3.17	M	TV	2
Physical Context	9.3.16	O 1)	TLV	>=2

- 1) Optional element for additional physical channel information.

The Request Reference element contains the random access reference value sent by MS in the CHANnel REQuest message and some low order bits of the absolute frame number for the reception of the access burst.

8.5.4 DELETE INDICATION

This message is sent from BTS to BSC to indicate the deletion of an access grant message (IMMediate ASSIGN) due to overload of downlink CCCH.

INFORMATION ELEMENT	REFERENCE	PRESENCE	FORMAT	LENGTH
Message discriminator	9.1	M	V	1
Message type	9.2	M	V	1
Channel number	9.3.1	M	TV	2
Full Imm. Assign Info	9.3.35	M	TLV	25

8.5.5 PAGING COMMAND

This message is sent from BSC to BTS to request the paging of an MS.

INFORMATION ELEMENT	REFERENCE	PRESENCE	FORMAT	LENGTH
Message discriminator	9.1	M	V	1
Message type	9.2	M	V	1
Channel number	9.3.1	M	TV	2
Paging Group	9.3.14	M	TV	2
MS Identity	9.3.12	M	TLV	2-10
Channel Needed	9.3.40	O 1)	TV	2
eMLPP Priority	9.3.49	O 2)	TV	2

- 1) If the Channel Needed element is not present, the default value is assumed to be 00 (any channel).
- 2) If the eMLPP Priority is not present then the BTS does not include the eMLPP priority in the radio interface message.

The Paging Group element is used by BTS to calculate the correct DRX paging block to be used for the transmission of the PAGing REQuest message as defined in 3GPP TS 45.002.

8.5.6 IMMEDIATE ASSIGN COMMAND

This message is sent from BSC to BTS to request the transmission of an immediate assignment message.

INFORMATION ELEMENT	REFERENCE	PRESENCE	FORMAT	LENGTH
Message discriminator	9.1	M	V	1
Message type	9.2	M	V	1
Channel number	9.3.1	M	TV	2
Full Imm. Assign Info	9.3.35	M	TLV	25

The Full Imm. Assign Info element contains the relevant immediate assignment message as defined in 3GPP TS 44.018 (IMMEDIATE ASSIGNMENT or IMMEDIATE ASSIGNMENT EXTENDED or IMMEDIATE ASSIGNMENT REJECT) with the "Page Mode" element set to the value "no change".

8.5.7 SMS BROADCAST REQUEST

This message is sent from BSC to BTS to request the sending of a Short Message Service Cell Broadcast message.

INFORMATION ELEMENT	REFERENCE	PRESENCE	FORMAT	LENGTH
Message discriminator	9.1	M	V	1
Message type	9.2	M	V	1
Channel number	9.3.1	M	TV	2
SMSCB Information	9.3.36	M	TV	24
SMSCB Channel Indicator	9.3.44	O 1)	TV	2

The SMSCB Information element contains the complete information to be broadcast on the CBCH as defined in 3GPP TS 44.012 (including the Layer 2 header to be used on the radio path).

- 1) The SMSCB Channel Indicator IE indicates the CBCH which shall be used for broadcasting the data. If this information element is not present the basic CBCH (see 3GPP TS 45.002) shall be used.

8.5.8 SMS BROADCAST COMMAND

This message is sent from BSC to BTS to command Short Message Service Cell Broadcast.

INFORMATION ELEMENT	REFERENCE	PRESENCE	FORMAT	LENGTH
Message discriminator	9.1	M	V	1
Message type	9.2	M	V	1
Channel number	9.3.1	M	TV	2
CB Command type	9.3.41	M	TV	2
SMSCB message	9.3.42	M	TLV	2-90
SMSCB Channel Indicator	9.3.44	O 1)	TV	2

The CB Command type IE contains the command to be performed, allowing the BSC to:

- request immediate broadcast i.e. transmission in the next CBCH opportunity;
- set the BTS broadcast default mode.

The SMSCB message IE contains the actual message to be broadcast on the CBCH i.e. a maximum of 88 octets of data. The BTS is responsible for performing the segmentation, building the block types and padding if necessary, see 3GPP TS 44.012 for the message format on the radio path.

- 1) The SMSCB Channel Indicator IE indicates the CBCH which shall be used for broadcasting the data. If this information element is not present the basic CBCH [see 3GPP TS 45.002] shall be used.

8.5.9 CBCH LOAD INDICATION

This message is sent from BTS to BSC to indicate a CBCH underflow/overflow situation in the BTS and to request the BSC to accelerate or pause the cell broadcast for a period indicated by BTS.

INFORMATION ELEMENT	REFERENCE	PRESENCE	FORMAT	LENGTH
Message discriminator	9.1	M	V	1
Message type	9.2	M	V	1
Channel number	9.3.1	M	TV	2
CBCH Load Information	9.3.43	M	TV	2
SMSCB Channel Indicator	9.3.44	O 1)	TV	2

The CBCH Load Information element indicates the load situation in CBCH (underflow/overflow) and information about the requested acceleration/suspension period of cell broadcast.

1) The SMSCB Channel Indicator IE indicates the CBCH which shall be used for broadcasting the data. If this information element is not present the basic CBCH [see 3GPP TS 45.002] shall be used.

8.5.10 NOTIFICATION COMMAND

This message is sent from BSC to BTS to request a change of notification for voice group call.

INFORMATION ELEMENT	REFERENCE	PRESENCE	FORMAT	LENGTH
Message discriminator	9.1	M	V	1
Message type	9.2	M	V	1
Channel number	9.3.1	M	TV	2
Command indicator	9.3.48	M 1)	TLV	3-4
Group call reference	9.3.45	O	TLV	7
Channel Description	9.3.46	O	TLV	3-n
NCH DRX information	9.3.47	O	TLV	3

- 1) This information element indicates the type of command that is to be performed by the BTS with respect to information contained in the rest of the message.

8.6 TRX MANAGEMENT MESSAGES

These messages are related to TRX Management procedures. They all have the following general format (no channel number included):

INFORMATION ELEMENT	REFERENCE	PRESENCE	FORMAT	LENGTH
Message discriminator	9.1	M	V	1
Message type	9.2	M	V	1
(Information elements depending on message type)				

The messages concerned are the following:

<u>Message name</u>	<u>Reference sub-clause</u>
RF RESource INDication	8.6.1
SACCH FILLing	8.6.2
OVERLOAD	8.6.3
ERROR REPORT	8.6.4

8.6.1 RF RESOURCE INDICATION

This message is sent from BTS to BSC to indicate the interference level on idle channels of a TRX.

INFORMATION ELEMENT	REFERENCE	PRESENCE	FORMAT	LENGTH
Message discriminator	9.1	M	V	1
Message type	9.2	M	V	1
Resource Information	9.3.21	M	TLV	>=2

8.6.2 SACCH FILLING

This message is sent from BSC to BTS to indicate the new broadcast information to be used as filling information on downlink SACCH.

INFORMATION ELEMENT	REFERENCE	PRESENCE	FORMAT	LENGTH
Message discriminator	9.1	M	V	1
Message type	9.2	M	V	1
System Info Type	9.3.30	M	TV	2
L3 Info (SYS INFO)	9.3.11	O 1)	TLV	22
Starting Time	9.3.23	O 2)	TV	3

- 1) If the L3 Info information element is not included this indicates that transmission of the indicated SYSTEM INFORMATION message shall be stopped.
- 2) The Starting Time element is optionally used to indicate when transmission of the new information is to start and when transmission is to stop.

The System Info Type element indicates the type of SYSTEM INFORMATION message which follows in the L3 Info field.

The L3 Information element contains the relevant SYSTEM INFORMATION message as defined in 3GPP TS 44.018.

8.6.3 OVERLOAD

This message is sent from BTS to BSC to indicate an overload situation. Possible cause values include:

- CCCH overload;
- ACCH overload;
- processor overload.

INFORMATION ELEMENT	REFERENCE	PRESENCE	FORMAT	LENGTH
Message discriminator	9.1	M	V	1
Message type	9.2	M	V	1
Cause	9.3.26	M	TLV	>=3

8.6.4 ERROR REPORT

This message is sent from BTS to BSC to report a detected error which cannot be reported in any other message.

INFORMATION ELEMENT	REFERENCE	PRESENCE	FORMAT	LENGTH
Message discriminator	9.1	M	V	1
Message type	9.2	M	V	1
Cause	9.3.26	M	TLV	>=3
Message Identifier	9.3.28	O 1)	TV	2
Channel Number	9.3.1	O 2)	TV	2
Link identifier	9.3.2	O 3)	TV	2
Erroneous Message	9.3.38	O 4)	TLV	>=3

- 1) Used to indicate which type of message was considered erroneous.
- 2) Used to indicate for which radio channel the error is reported.
- 3) Used to indicate for which radio L2 link the error is reported.
- 4) This element may be used to carry the complete erroneous message as it was received from the BSC.

8.7 LOCATION SERVICES MESSAGES

These messages are related to Location Services (LCS).

8.7.1 LOCATION INFORMATION

This message is sent by the BSC, the BTS or Sandalone Type B LMU via Abis interface to convey an embedded LCS LLP message.

INFORMATION ELEMENT	REFERENCE	PRESENCE	FORMAT	LENGTH
Message discriminator	9.1	M	V	1
Message type	9.2	M	V	1
LLP APDU	9.3.58	M	LV	2-N

9 Information element codings

This sub-clause contains the codings of the signalling elements used. The following conventions are assumed for the sequence of transmission of bits and bytes:

- Each bit position is numbered as 1 to 8.

8	7	6	5	4	3	2	1
---	---	---	---	---	---	---	---
- The least significant bit is bit 1 and is transmitted first, followed by bits 2, 3, 4 etc.
- In an element, octets are identified by number. Octet 1 is transmitted first, then octet 2 etc.
- When a field extends over more than one octet, the order of bit values progressively decreases as the octet number increases. The least significant bit of the field is represented by the lowest numbered bit of the highest numbered octet of the field.
- For variable length elements, a length indicator is included. This indicates the number of octets following in the element.
- All spare or reserved bits are set to 0.

9.1 Message discriminator

A 1 octet field is used in all messages to discriminate between Transparent and Non-Transparent messages and also between Radio Link Layer Management, Dedicated Channel Management, Common Channel Management, TRX Management and Location Services messages.

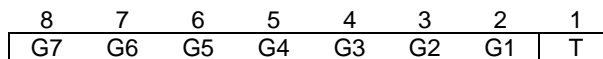

The T-bit is set to 1 to indicate that the message is to be/was considered transparent by BTS. All other messages shall have the T-bit set to 0.

The G-bits are used to group the messages as follows:

G7	G6	G5	G4	G3	G2	G1	Message Group
0	0	0	0	0	0	0	reserved
0	0	0	0	0	0	1	Radio Link Layer Management messages
0	0	0	0	1	0	0	Dedicated Channel Management messages
0	0	0	0	1	1	0	Common Channel Management messages
0	0	0	1	0	0	0	TRX Management messages
0	0	1	0	0	0	0	Location Services messages

All other values are reserved for future use.

9.2 MESSAGE TYPE

The Message Type uniquely identifies the function of the message being sent. It is a single octet and coded in the following way:

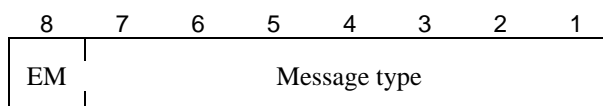

Bit 8 is the extension bit and is reserved for future use. The following message types are used (all other values are reserved):

8 7 6 5 4 3 2 1	Message	Reference
0 0 0 0 - - - -	Radio Link Layer Management messages:	

0 0 0 1	- DATA REQuest	8.3.1
0 0 1 0	- DATA INDication	8.3.2
0 0 1 1	- ERROR INDication	8.3.3
0 1 0 0	- ESTablish REQuest	8.3.4
0 1 0 1	- ESTablish CONFirm	8.3.5
0 1 1 0	- ESTablish INDication	8.3.6
0 1 1 1	- RELease REQuest	8.3.7
1 0 0 0	- RELease CONFirm	8.3.8
1 0 0 1	- RELease INDication	8.3.9
1 0 1 0	- UNIT DATA REQuest	8.3.10
1 0 1 1	- UNIT DATA INDication	8.3.11

0 0 0 1 - - - - Common Channel Management/TRX Management messages:

0 0 0 1	- BCCH INFOrmation	8.5.1
0 0 1 0	- CCCH LOAD INDication	8.5.2
0 0 1 1	- CHANnel ReQuireD	8.5.3
0 1 0 0	- DELETE INDication	8.5.4
0 1 0 1	- PAGING CoMmanD	8.5.5
0 1 1 0	- IMMEDIATE ASSIGN COMMAND	8.5.6
0 1 1 1	- SMS BroadCast REQuest	8.5.7
1 0 0 1	- RF RESource INDication	8.6.1
1 0 1 0	- SACCH FILLing	8.6.2
1 0 1 1	- OVERLOAD	8.6.3
1 1 0 0	- ERROR REPORT	8.6.4
1 1 0 1	- SMS BroadCast CoMmanD	8.5.8
1 1 1 0	- CBCH LOAD INDication	8.5.9
1 1 1 1	- NOTification CoMmanD	8.5.10

0 0 1 - - - - Dedicated Channel Management messages:

0 0 0 0 1	- CHANnel ACTIVation	8.4.1
0 0 0 1 0	- CHANnel ACTIVation ACKnowledge	8.4.2
0 0 0 1 1	- CHANnel ACTIVation Negative ACK	8.4.3
0 0 1 0 0	- CONNection FAILure	8.4.4
0 0 1 0 1	- DEACTIVATE SACCH	8.4.5
0 0 1 1 0	- ENCRyption CoMmanD	8.4.6
0 0 1 1 1	- HANDOver DETection	8.4.7
0 1 0 0 0	- MEASurement RESult	8.4.8
0 1 0 0 1	- MODE MODIFY REQuest	8.4.9
0 1 0 1 0	- MODE MODIFY ACKnowledge	8.4.10
0 1 0 1 1	- MODE MODIFY Negative ACKnowledge	8.4.11
0 1 1 0 0	- PHYsical CONTEXT REQuest	8.4.12
0 1 1 0 1	- PHYsical CONTEXT CONFirm	8.4.13
0 1 1 1 0	- RF CHANnel RELease	8.4.14
0 1 1 1 1	- MS POWER CONTROL	8.4.15
1 0 0 0 0	- BS POWER CONTROL	8.4.16
1 0 0 0 1	- PREPROCess CONFigure	8.4.17
1 0 0 1 0	- PREPROCessed MEASurement RESult	8.4.18
1 0 0 1 1	- RF CHANnel RELease ACKnowledge	8.4.19
1 0 1 0 0	- SACCH INFO MODIFY	8.4.20
1 0 1 0 1	- TALKER DETection	8.4.21
1 0 1 1 0	- LISTENER DETection	8.4.22
1 0 1 1 1	- REMOTE CODEC CONFiguration REPort	8.4.23
1 1 0 0 0	- Round Trip Delay REPort	8.4.24
1 1 0 0 1	- PRE-HANDOver NOTIFication	8.4.25
1 1 0 1 0	- MultiRate CODEC MODification REQuest	8.4.26
1 1 0 1 1	- MultiRate CODEC MOD ACKnowledge	8.4.27
1 1 1 0 0	- MultiRate CODEC MOD Negative ACKnowledge	8.4.28
1 1 1 0 1	- MultiRate CODEC MOD PERformed	8.4.29
1 1 1 1 0	- TFO REPort	8.4.30
1 1 1 1 1	- TFO MODification REQuest	8.4.31

0 1 - - - - -	Location Services messages:	
0 0 0 0 0 1	- Location Information	8.7.1

9.3 Other information elements

The information elements used and the coding of their Element Identifier fields are:

Element Identifier bits 8 7 6 5 4 3 2 1	Element name	Reference
0 0 0 0 0 0 0 1	Channel Number	9.3.1
0 0 0 0 0 0 1 0	Link Identifier	9.3.2
0 0 0 0 0 0 1 1	Activation Type	9.3.3
0 0 0 0 0 1 0 0	BS Power	9.3.4
0 0 0 0 0 1 0 1	Channel Identification	9.3.5
0 0 0 0 0 1 1 0	Channel Mode	9.3.6
0 0 0 0 0 1 1 1	Encryption Information	9.3.7
0 0 0 0 1 0 0 0	Frame Number	9.3.8
0 0 0 0 1 0 0 1	Handover Reference	9.3.9
0 0 0 0 1 0 1 0	L1 Information	9.3.10
0 0 0 0 1 0 1 1	L3 Information	9.3.11
0 0 0 0 1 1 0 0	MS Identity	9.3.12
0 0 0 0 1 1 0 1	MS Power	9.3.13
0 0 0 0 1 1 1 0	Paging Group	9.3.14
0 0 0 0 1 1 1 1	Paging Load	9.3.15
0 0 0 1 0 0 0 0	Physical Context	9.3.16
0 0 0 1 0 0 0 1	Access Delay	9.3.17
0 0 0 1 0 0 1 0	RACH Load	9.3.18
0 0 0 1 0 0 1 1	Request Reference	9.3.19
0 0 0 1 0 1 0 0	Release Mode	9.3.20
0 0 0 1 0 1 0 1	Resource Information	9.3.21
0 0 0 1 0 1 1 0	RLM Cause	9.3.22
0 0 0 1 0 1 1 1	Starting Time	9.3.23
0 0 0 1 1 0 0 0	Timing Advance	9.3.24
0 0 0 1 1 0 0 1	Uplink Measurements	9.3.25
0 0 0 1 1 0 1 0	Cause	9.3.26
0 0 0 1 1 0 1 1	Measurement result number	9.3.27
0 0 0 1 1 1 0 0	Message Identifier	9.3.28
0 0 0 1 1 1 0 1	reserved	
0 0 0 1 1 1 1 0	System Info Type	9.3.30
0 0 0 1 1 1 1 1	MS Power Parameters	9.3.31
0 0 1 0 0 0 0 0	BS Power Parameters	9.3.32
0 0 1 0 0 0 0 1	Pre-processing Parameters	9.3.33
0 0 1 0 0 0 1 0	Pre-processed Measurements	9.3.34
0 0 1 0 0 0 1 1	reserved	
0 0 1 0 0 1 0 0	SMSCB Information	9.3.36
0 0 1 0 0 1 0 1	MS Timing Offset	9.3.37
0 0 1 0 0 1 1 0	Erroneous Message	9.3.38
0 0 1 0 0 1 1 1	Full BCCH Information	9.3.39
0 0 1 0 1 0 0 0	Channel Needed	9.3.40
0 0 1 0 1 0 0 1	CB Command type	9.3.41
0 0 1 0 1 0 1 0	SMSCB message	9.3.42
0 0 1 0 1 0 1 1	Full Immediate Assign Info	9.3.35
0 0 1 0 1 1 0 0	SACCH Information	9.3.29
0 0 1 0 1 1 0 1	CBCH Load Information	9.3.43
Element Identifier bits 8 7 6 5 4 3 2 1	Element name	Reference
0 0 1 0 1 1 1 0	SMSCB Channel Indicator	9.3.44

00101111	Group call reference	9.3.45
00110000	Channel description	9.3.46
00110001	NCH DRX information	9.3.47
00110010	Command indicator	9.3.48
00110011	eMLPP Priority	9.3.49
00110100	UIC	9.3.50
00110101	Main channel reference	9.3.51
00110110	MultiRate configuration	9.3.52
00110111	MultiRate Control	9.3.53
00111000	Supported Codec Types	9.3.54
00111001	Codec Configuration	9.3.55
00111010	Round Trip Delay	9.3.56
00111011	TFO Status	9.3.57
00111100	LLP APDU	9.3.58
00111101	TFO transparent container	9.3.59
00111110		
to	Reserved for future use	
11101111		
11110000		
to	Not used	
11111111		

9.3.1 Channel Number

In the direction BSC to BTS the Channel Number parameter is used to indicate on which physical channel/subchannel the message is to be sent. In the direction BTS to BSC the Channel Number indicates on which physical channel/subchannel the message was received. It is coded in two octets as follows:

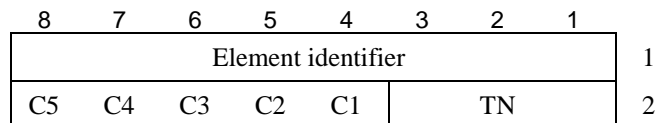

The C-bits describe the channel as follows:

C5	C4	C3	C2	C1	
0	0	0	0	1	Bm + ACCH's
0	0	0	1	T	Lm + ACCH's
0	0	1	T	T	SDCCH/4 + ACCH
0	1	T	T	T	SDCCH/8 + ACCH
1	0	0	0	0	BCCH
1	0	0	0	1	Uplink CCCH (RACH)
1	0	0	1	0	Downlink CCCH (PCH + AGCH)

The T-bits indicate, coded in binary, the sub-channel number as specified in 3GPP TS 45.002.

TN is time slot number, binary represented as in 3GPP TS 45.002.

9.3.2 Link Identifier

This element identifies the signalling channel and SAPI of the radio data link.

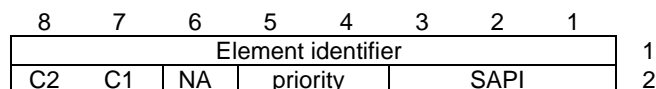

The NA bit (bit 6 in octet 2) is set to 1 to indicate that the Link Identifier is not applicable for this message. In all other cases it is set to 0.

The C-bits indicate the channel type as follows:

C2 C1	
0 0	main signalling channel (FACCH or SDCCH)
0 1	SACCH

All other values are reserved for future use.

The SAPI field contains the SAPI value as defined in 3GPP TS 44.005.

The priority field contains the message priority for SAPI 0, as defined in 3GPP TS 44.006, as follows:

0 0	normal priority
0 1	high priority
1 0	low priority

All other values for SAPI 0 and all values for other SAPIs are reserved for future use.

9.3.3 Activation Type

This element is used to indicate the type of activation requested in the CHANnel ACTIVation message. It is coded in two octets as follows:

8	7	6	5	4	3	2	1	
Element identifier								1
R	Reserved				A3	A2	A1	2

The R bit indicates if the procedure is an initial activation or a reactivation.

R	
0	Initial activation
1	Reactivation

The A-bits indicate the type of activation, which defines the access procedure and the operation of the data link layer, as follows:

<u>A3 A2 A1</u>		
0 0	-	Activation related to intra-cell channel change
	0	- related to immediate assignment procedure
	1	- related to normal assignment procedure
0 1	-	Activation related to inter-cell channel change (handover)
	0	- related to asynchronous handover procedure
	1	- related to synchronous handover procedure
1 0	-	Activation related to secondary channels
	0	- related to additional assignment procedure
	1	- related to multislot configuration

All other values reserved for future use.

NOTE: For the main TCH channel in a Multislot configuration activation types for intra-cell and inter-cell channel change are used.

9.3.4 BS Power

This information element indicates the TRX transmission power level and the use of fast power control and enhanced power control on a particular channel.

8	7	6	5	4	3	2	1	
Element identifier								1
Reserved		EPC mode	FPC_E PC	Power Level				2

The EPC mode field (octet 2) indicates whether the activated channel shall be in enhanced power control (EPC) mode. It is only valid for channels on which EPC may be used. It is coded as follows:

Value

- 0 Channel not in EPC mode
- 1 Channel in EPC mode

NOTE: The EPC mode field is only valid in the CHANNEL ACTIVATION message.

The FPC_EPC (Fast Power Control/Enhanced Power Control) field (octet 2) has different interpretation depending on the channel mode of the channel and whether the channel is in EPC mode.

If the channel mode is such that FPC may be used, the FPC_EPC field indicates whether Fast Measurement Reporting and Power Control mechanism is used. It is coded as follows:

Value

- 0 Fast Power Control not in use
- 1 Fast Power Control in use

If the channel is in EPC mode, the FPC_EPC field indicates whether EPC procedures are used for BS (downlink) power control. It is coded as follows:

Value

- 0 EPC not in use for BS power control
- 1 EPC in use for BS power control

If the channel mode is such that FPC may not be used and the channel is not in EPC mode, the BTS shall ignore the value of the FPC_EPC field and the BSC shall set its value to 0.

The Power Level field (octet 2) indicates the number of 2 dB steps by which the power shall be reduced from its nominal value, P_n , set by the network operator to adjust the coverage. Thus the Power Level values correspond to the following powers (relative to P_n):

Value	Power level
0 0 0 0	P_n
0 0 0 1	$P_n - 2$ dB
0 0 1 0	$P_n - 4$ dB
.	
.	
0 1 1 1 0	$P_n - 28$ dB
0 1 1 1 1	$P_n - 30$ dB
All other values are reserved for future use.	

See also 3GPP TS 45.005 and 3GPP TS 45.008.

9.3.5 Channel Identification

This information element describes some aspects of a channel together with its SACCH.

8	7	6	5	4	3	2	1	
Element identifier								1
Length								2
3GPP TS 44.018 "Channel Description"								*
3GPP TS 44.018 "Mobile Allocation"								*

A * denotes that the whole of the 3GPP TS 44.018 element including the element identifier and length should be included. The 3GPP TS 24.008 "Mobile Allocation" shall for compatibility reasons be included but empty, i.e. the length shall be zero.

9.3.6 Channel Mode

This element gives information on the mode of coding/decoding and transcoding/rate adaption of a channel.

8	7	6	5	4	3	2	1	
Element identifier								1
Length								2
Reserved for future use					DTXd	DTXu		3
Speech or data indicator								4
Channel rate and type								5
Speech coding algor./data rate + transp ind								6

The DTX bits of octet 3 indicate whether DTX is applied:

- 1 DTX is applied
- 0 DTX is not applied.

DTXd indicates use of DTX in the downlink direction (BTS to MS) and DTXu indicates use of DTX in the uplink direction (MS to BTS).

The "Speech or data indicator" field (octet 4) is coded as follows:

0000 0001	Speech
0000 0010	Data
0000 0011	Signalling

All other values are reserved.

The "Channel rate and type" field (octet 5) is coded as follows:

0000 0001	SDCCH
0000 1000	Full rate TCH channel Bm
0000 1001	Half rate TCH channel Lm
0000 1010	Full rate TCH channel bi-directional Bm, Multislot configuration
0001 1010	Full rate TCH channel uni-directional downlink Bm, Multislot configuration
0001 1000	Full rate TCH channel Bm Group call channel
0001 1001	Half rate TCH channel Lm Group call channel
0010 1000	Full rate TCH channel Bm Broadcast call channel
0010 1001	Half rate TCH channel Lm Broadcast call channel
All other values are reserved.	

The "speech coding algorithm/data rate + transparency indicator" field (octet 6) is coded as follows:

If octet 4 indicates speech, then octet 6 is coded as follows:

0000 0001	GSM speech coding algorithm version 1
0001 0001	GSM speech coding algorithm version 2
0010 0001	GSM speech coding algorithm version 3
0011 0001	GSM speech coding algorithm version 4
0000 1001	GSM speech coding algorithm version 5
0000 1101	GSM speech coding algorithm version 6
All other values are reserved.	

If octet 4 indicates signalling then octet 6 is coded as follows:

0000 0000 No resources required

All other values are reserved.

NOTE: the GSM speech coding algorithm versions are also referred as follows (see 3GPP TS 26.103 [18]):

- GSM speech coding algorithm version 1: GSM FR or GSM HR
- GSM speech coding algorithm version 2: GSM EFR (half rate not defined in this version of the protocol)
- GSM speech coding algorithm version 3: FR AMR or HR AMR
- GSM speech coding algorithm version 4: OFR AMR-WB or OHR AMR-WB
- GSM speech coding algorithm version 5: FR AMR-WB
- GSM speech coding algorithm version 6: OHR AMR

If octet 4 indicates data, then octet 6 is coded as follows:

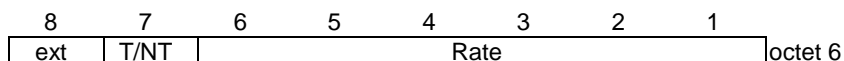

Bit 8: Reserved for extension

Bit 7: 0 Transparent service

1 Non-transparent service.

For the non-transparent service, bits 6 to 1 indicate the radio interface data rate:

65 4321

10 0001	asymmetric 43.5 kbit/s (downlink) + 14.5 kbit/s (uplink)
10 0010	asymmetric 29.0 kbit/s (downlink) + 14.5 kbit/s (uplink)
10 0011	asymmetric 43.5 kbit/s (downlink) + 29.0 kbit/s (uplink)
10 1001	asymmetric 14.5 kbit/s (downlink) + 43.5 kbit/s (uplink)
10 1010	asymmetric 14.5 kbit/s (downlink) + 29.0 kbit/s (uplink)
10 1011	asymmetric 29.0 kbit/s (downlink) + 43.5 kbit/s (uplink)
11 0100	43.5 kbit/s
11 0001	28.8 kbit/s
01 1000	14.5 kbit/s
01 0000	12 kbit/s
01 0001	6 kbit/s
all other values are reserved.	

For the transparent service, bits 6-1 indicate the data rate:

65 4321

11 1000	32 kbit/s
11 1001	29 kbit/s
01 1000	14.4 kbit/s
01 0000	9.6 kbit/s
01 0001	4.8 kbit/s
01 0010	2.4 kbit/s
01 0011	1.2 kbit/s

01 0100 600 bit/s
 01 0101 1 200/75 bit/s (1 200 network-to-MS, 75 MS-to-network)
 All other values are reserved.

9.3.7 Encryption information

This element is a variable length element. It contains necessary information to control encryption devices.

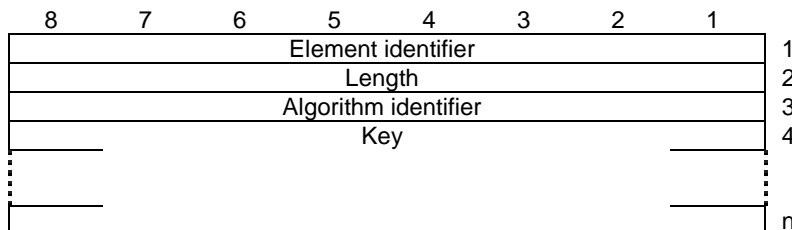

The Algorithm Identifier field (octet 3) indicates the relevant ciphering algorithm. It is coded as:

0000 0000	Reserved
0000 0001	No encryption shall be used.
0000 0010	GSM encryption algorithm version 1 (A5/1)
0000 0011	GSM A5/2
0000 0100	GSM A5/3
0000 0101	GSM A5/4
0000 0110	GSM A5/5
0000 0111	GSM A5/6
0000 1000	GSM A5/7
All other values are reserved	

The Key field (octets 4-n) indicates the ciphering key. It shall be an integral number of octets and the length is given as the value of the Length field minus 1.

9.3.8 Frame Number

This element contains the absolute frame number (FN) modulo 42432. It is used to carry the current timing in BTS to BSC for calculation of the Starting Time parameter required in some messages.

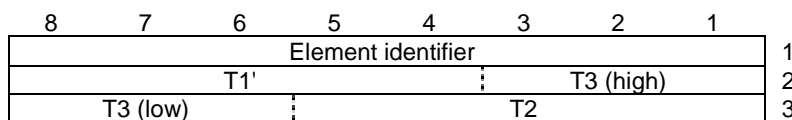

Octets 2-3 are coded as defined for octets 2-3 of the Starting Time information element of 3GPP TS 44.018.

9.3.9 Handover reference

The information is coded in two octets and contains the hand-over reference value.

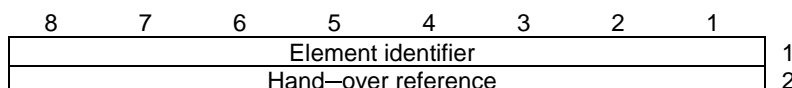

The Handover Reference octet contains the handover reference value as defined in 3GPP TS 44.018.

9.3.10 L1 Information

This element carries the information used in the L1 header of SACCH blocks.

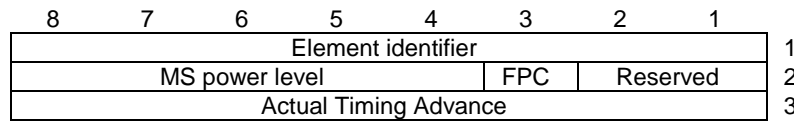

Octets 2-3 contain the L1 header information of SACCH blocks. The information fields and codings are as defined in 3GPP TS 44.004.

9.3.11 L3 Information (message name)

This element contains a link layer service data unit (L3 message). It is used to forward a complete L3 message as specified in 3GPP TS 24.008 or 3GPP TS 44.018 between BTS and BSC.

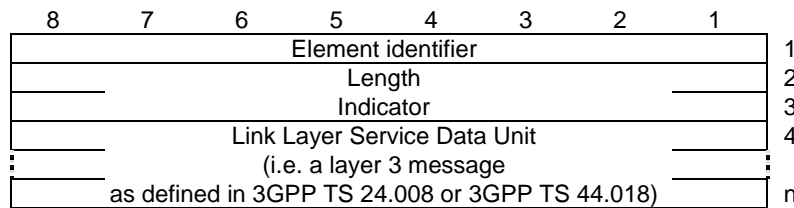

The Length Indicator field (octets 2-3) indicates in binary the remaining length of the element (octets 4-n). The most significant bit is bit 8 of octet 2 and the least significant bit is bit 1 of octet 3.

Octets 4-n contain the complete L3 message as defined in 3GPP TS 24.008 or in 3GPP TS 44.018. In the message format sub-clause, the 3GPP TS 24.008 or 3GPP TS 44.018 message name to be included is indicated within brackets.

9.3.12 MS Identity

This element carries the identity of an MS (TMSI or IMSI). It is a variable length element.

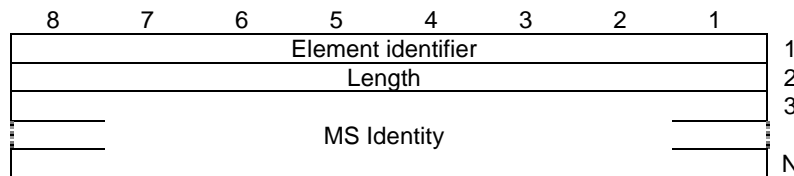

The MS Identity field (octets 3-N) is coded as specified for the Mobile Identity information element of 3GPP TS 24.008, octets 3-N.

9.3.13 MS Power

This element carries the power level of MS and indicates the use of fast power control and enhanced power control.

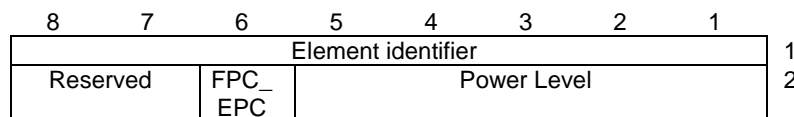

The FPC_EPC (Fast Power Control/Enhanced Power Control) field (octet 2) has different interpretation depending on the channel mode of the channel and whether the channel is in EPC mode.

If the channel mode is such that FPC may be used, the FPC_EPC field indicates whether Fast Measurement Reporting and Power Control mechanism is used. It is coded as follows:

Value

- 0 Fast Power Control not in use
- 1 Fast Power Control in use

If the channel is in EPC mode, the FPC_EPC field indicates whether EPC procedures are used for MS (uplink) power control. It is coded as follows:

Value

- 0 EPC not in use for MS power control
- 1 EPC in use for MS power control

If the channel mode is such that FPC may not be used and the channel is not in EPC mode, the BTS shall ignore the value of the FPC_EPC field and the BSC shall set its value to 0.

The coding and meaning of the Power Level field is as defined in 3GPP TS 45.005 and 3GPP TS 45.008. See also 3GPP TS 44.004.

9.3.14 Paging Group

This element carries the paging population of an MS to be paged.

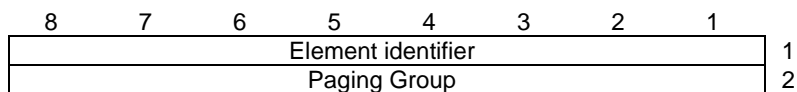

The Paging Group field (octet 2) contains the binary representation of the paging group as defined in 3GPP TS 45.002.

9.3.15 Paging Load

This element carries data about the load of a paging channel (PCH).

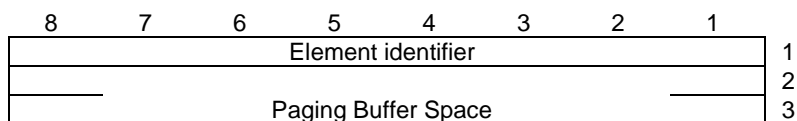

The Paging Buffer Space field (octets 2-3) indicates the remaining space for Paging Commands associated with this CCCH timeslot, given as the number of additional Paging Commands that it is possible to store. The number is binary coded with the most significant bit in bit 8 of octet 2 and the least significant bit in bit 1 of octet 3.

9.3.16 Physical Context

This element contains supplementary information on the transmission/reception process. It is a variable length element.

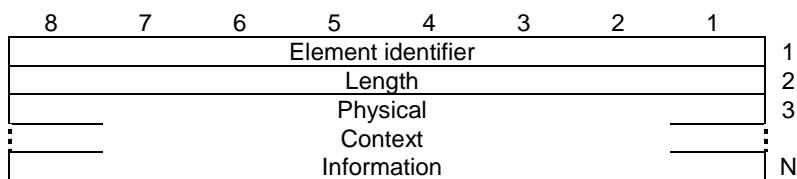

The Physical Context Information field is not specified. This information should not be analysed by BSC, but merely forwarded from one TRX/channel to another.

9.3.17 Access Delay

This element contains the delay of the access burst as measured by BTS at random access or at handover access.

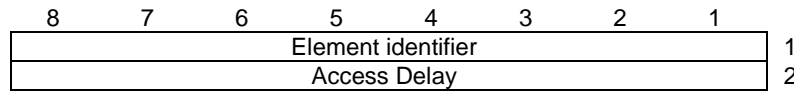

The Access Delay field contains the delay of the access burst as measured by BTS. The delay is expressed as defined for the Timing Advance TA in 3GPP TS 45.010 but with the range extended to 8 bits, i.e. the six least significant bits of the field correspond to the Timing Advance except for GSM 400 where all the 8 bits are used.

9.3.18 RACH Load

This element is used to carry information on the load of the RACH (Random Access Channel) associated with this CCCH timeslot. It is of variable length.

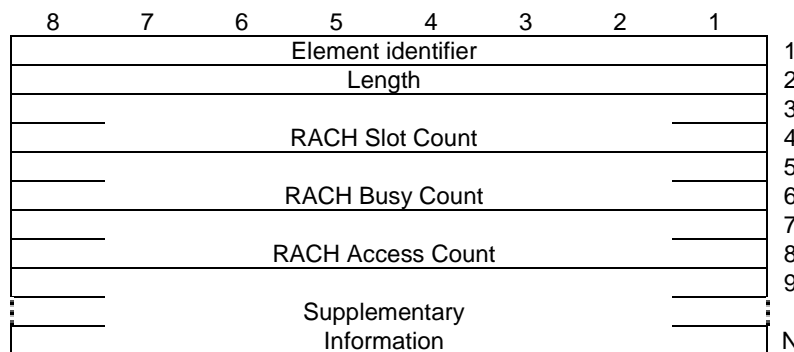

The RACH Slot Count field (octets 3-4) indicates the total number of available access slots over which the measurement (counting) was performed. The value is binary coded with the most significant bit in bit 8 of the first octet and the least significant bit in bit 1 of the second octet.

The RACH Busy Count field (octets 5-6) indicates the number of RACH burst periods during which the received signal level has exceeded a given threshold. This will give a measure of the number of "busy" random access slots. The value is binary coded with the most significant bit in bit 8 of the first octet and the least significant bit in bit 1 of the second octet.

The RACH Access Count field (octets 7-8) indicates the number of received access bursts during the same measurement period. The value is binary coded with the most significant bit in bit 8 of the first octet and the least significant bit in bit 1 of the second octet.

The busy count signal level threshold and the measurement period are parameters set by O&M.

The Supplementary Information field may carry additional operator dependent information.

9.3.19 Request Reference

This element carries the Request Reference parameters used for contention resolution on RACH.

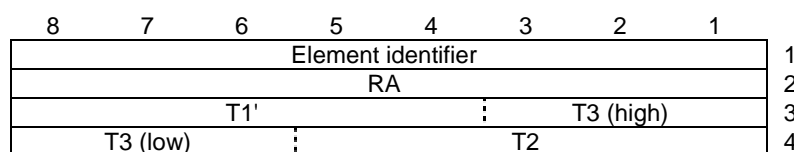

Octets 2-4 are coded as the corresponding fields of the Request Reference element of 3GPP TS 44.018. (Octet 2, RA, is the Random Access Information field set by MS in the CHANnel REQuest message. Octets 3-4 contain the absolute frame number modulo 42432 for the frame number when the access burst was received, see Starting Time information element of 3GPP TS 44.018).

9.3.20 Release Mode

This element is used to distinguish between normal release and local end release of the radio data link connection.

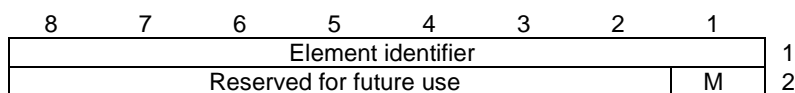

The M bit is coded as follows:

- 0 normal release
- 1 local end release

9.3.21 Resource Information

This element is used to indicate the interference level for each of the idle channels of a TRX.

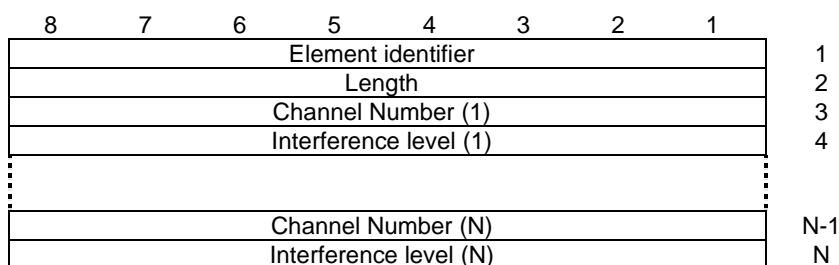

The Length field indicates in binary the remaining length of the element (octets 3-N).

Octets 3-N forms a list of Channel Numbers and Interference levels measured on the corresponding channel.

The Channel Number octet is coded as octet 2 of the Channel Number information element, sub-clause 9.3.1.

The Interference Level octet is coded as follows:

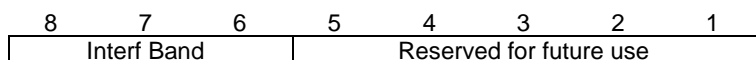

The Interf Band field (bits 6-8) indicates in binary the interference level expressed as one of five possible interference level bands as defined by O&M. The interference level is averaged over a period of Intave (parameter set by O&M, see 3GPP TS 45.008) immediately before the transmission of the RF RESource INDication message. See also 3GPP TS 48.008 and 3GPP TS 45.008.

9.3.22 RLM Cause

This element is used to indicate the precise protocol error or the reason for a release on the radio link layer.

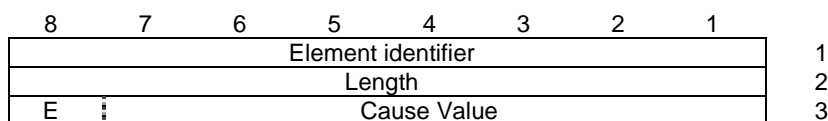

The Cause Value is a one octet field if the extension bit is set to 0. If the extension bit is set to 1, the Cause Value is a two octet field.

The Cause Value field is coded as follows:

8	7	6	5	4	3	2	1	
0	0	0	0	0	0	0	0	reserved
0	0	0	0	0	0	0	1	timer T200 expired (N200+1) times
0	0	0	0	0	0	1	0	re-establishment request
0	0	0	0	0	0	1	1	unsolicited UA response
0	0	0	0	1	0	0	0	unsolicited DM response
0	0	0	0	1	0	1	0	unsolicited DM response, multiple frame established state
0	0	0	0	1	1	0	0	unsolicited supervisory response
0	0	0	0	1	1	1	1	sequence error
0	0	0	1	0	0	0	0	U-frame with incorrect parameters
0	0	0	1	0	0	1	0	S-frame with incorrect parameters
0	0	0	1	0	1	0	0	I-frame with incorrect use of M bit
0	0	0	1	0	1	1	1	I-frame with incorrect length
0	0	0	1	1	0	0	0	frame not implemented
0	0	0	1	1	0	1	0	SABM command, multiple frame established state
0	0	0	1	1	1	0	0	SABM frame with information not allowed in this state
All other values are reserved for future use.								

9.3.23 Starting Time

This element provides the starting time expressed as FN modulo 42432 (FN is absolute frame number).

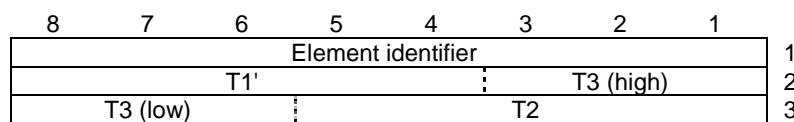

Octets 2-3 are coded as defined for octets 2-3 of the Starting Time information element of 3GPP TS 44.018.

9.3.24 Timing Advance

This element contains the timing advance to be used by MS in subsequent communications. It is calculated by BTS at the reception of a CHANnel REQuest message (random access burst) or a handover access burst.

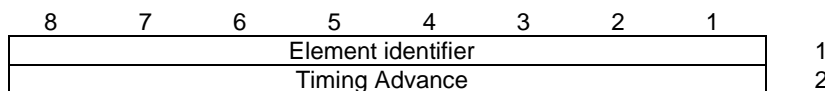

The Timing Advance field contains the timing advance TA as specified in 3GPP TS 45.010.

Bits 7-8 of octet 2 are used in GSM 400 for support of extended cell range. For all other bands bit 7-8 are spare according to 3GPP TS 44.018.

9.3.25 Uplink Measurements

This element is used to report the results of the TRX measurements on the uplink radio path of an activated basic radio channel. It is of variable length.

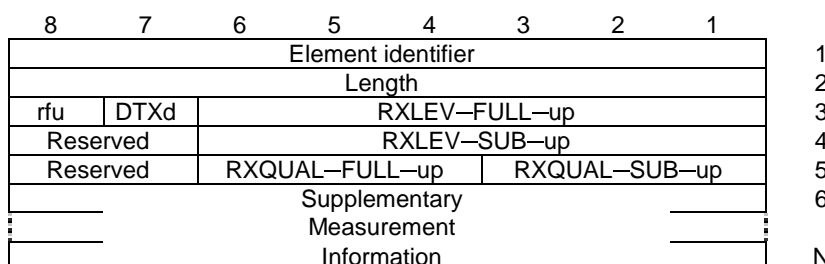

rfu = Reserved for Future Use.

The Length field indicates in binary the remaining length of the element (octets 3-N).

Octets 3-5 contain results from measurements made by TRX on the uplink.

The Supplementary Measurement Information field (octets 6-N) may carry additional operator dependent information.

The DTXd field (octet 3) indicates whether DTX was employed by TRX on the downlink transmission during the measurement period.

The RXLEV-FULL-up and RXLEV-SUB-up fields (octets 3-4) report the average uplink signal level as measured by TRX over the measurement period on all slots and on a subset of the slots respectively (see 3GPP TS 45.008). Each field is coded as defined in 3GPP TS 45.008.

The RXQUAL-FULL-up and RXQUAL-SUB-up fields (octet 5) report the average uplink quality as measured by TRX over the measurement period on all slots and on a subset of the slots respectively (see 3GPP TS 45.008). Each field is coded as defined in 3GPP TS 45.008.

9.3.26 Cause

The cause element is used to indicate the reason for a particular event to have occurred and is coded as shown below.

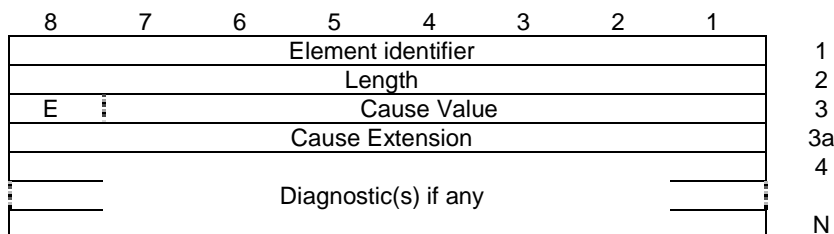

The Length field indicates in binary the remaining length of the element (octets 3-N).

The Cause Value is a single octet field (octet 3) if the extension bit E (bit 8) is set to 0. If it is set to 1 then the cause value is a 2 octet field (octets 3 and 3a).

The Cause Value is divided into two fields: a class (bits 5 to 7 of octet 3) and a value within the class (bits 1 to 4 of octet 3).

If the value of the first octet of the cause field is 1XXX 0000 then the second octet is reserved for national applications (XXX will still indicate the class).

Diagnostic information is not available for every cause, see the table below. When available, it is coded in the same way as the corresponding information element in clause 9. Inclusion of diagnostics is optional.

Classes:

- Class (000): Normal event
- Class (001): Normal event
- Class (010): Resource unavailable
- Class (011): Service or option not available
- Class (100): Service or option not implemented
- Class (101): Invalid message (e.g. parameter out of range)
- Class (110): Protocol error
- Class (111): Interworking

CAUSE VALUES:

Class	Value	Cause	Diagnostics
0 0 0	- - - -	Normal Event	
0 0 0	0 0 0 0	radio interface failure	Channel Number
0 0 0	0 0 0 1	radio link failure	Channel Number
0 0 0	0 0 1 0	handover access failure	Channel Number
0 0 0	0 0 1 1	talker access failure	Channel Number
0 0 0	0 1 0 0	reserved for international use	
0 0 0	0 1 0 1	reserved for international use	
0 0 0	0 1 1 0	reserved for international use	
0 0 0	0 1 1 1	O&M intervention	
0 0 0	1 0 0 0	reserved for international use	
0 0 0	1 : : :		
0 0 0	1 1 1 0		
0 0 0	1 1 1 1	normal event, unspecified	
0 0 1	- - - -	Normal Event	
0 0 1	0 0 0 0	reserved for international use	
0 0 1	0 : : :		
0 0 1	0 1 1 1		
0 0 1	1 0 0 0	reserved for national use	
0 0 1	1 : : :		
0 0 1	1 1 1 1		
0 1 0	- - - -	Resource unavailable	
0 1 0	0 0 0 0	equipment failure	
0 1 0	0 0 0 1	radio resource not available	Channel Number
0 1 0	0 0 1 0	terrestrial channel failure	Channel Number
0 1 0	0 0 1 1	CCCH overload	Channel Number
0 1 0	0 1 0 0	ACCH overload	Channel Number
0 1 0	0 1 0 1	processor overload	
0 1 0	0 1 1 0	reserved for international use	
0 1 0	0 1 1 1	BTS not equipped	
0 1 0	1 0 0 0	remote transcoder failure	Channel Number
0 1 0	1 0 0 1	notification overflow	Channel Number
0 1 0	1 0 1 0	reserved for international use	
0 1 0	1 0 1 1	reserved for international use	
0 1 0	1 1 0 0	reserved for national use	
0 1 0	1 1 0 1	reserved for national use	
0 1 0	1 1 1 0	reserved for national use	
0 1 0	1 1 1 1	resource not available, unspecified	
0 1 1	- - - -	Service or Option Not Available	
0 1 1	0 0 0 0	requested transcoding/rate adaption not available	Channel Number
0 1 1	0 0 0 1	reserved for international use	
0 1 1	: : : :		
0 1 1	1 1 1 0		
0 1 1	1 1 1 1	service or option not available, unspecified	
1 0 0	- - - -	Service or Option Not Implemented	
1 0 0	0 0 0 0	encryption algorithm not implemented	Channel Number
1 0 0	0 0 0 1	reserved for international use	
1 0 0	0 : : :		
1 0 0	0 1 1 1		
1 0 0	1 0 0 0	reserved for national use	
1 0 0	1 : : :		
1 0 0	1 1 1 0		
1 0 0	1 1 1 1	service or option not implemented, unspecified	
1 0 1	- - - -	Invalid Message	
1 0 1	0 0 0 0	radio channel already activated/allocated	Channel Number
1 0 1	0 0 0 1	reserved for international use	
1 0 1	0 : : :		
1 0 1	0 1 1 1		
1 0 1	1 0 0 0	reserved for national use	
1 0 1	1 : : :		
1 0 1	1 1 1 0		
1 0 1	1 1 1 1	invalid message, unspecified	
1 1 0	- - - -	Protocol Error	
1 1 0	0 0 0 0	message discriminator error	Message Discrim

Class	Value	Cause	Diagnostics
1 1 0	0 0 0 1	message type error	Message Type
1 1 0	0 0 1 0	message sequence error	Message Type
1 1 0	0 0 1 1	general information element error	
1 1 0	0 1 0 0	mandatory information element error	Element Identif
1 1 0	0 1 0 1	optional information element error	Element Identif
1 1 0	0 1 1 0	information element non-existent	Element Identif
1 1 0	0 1 1 1	information element length error	Element Identif
1 1 0	1 0 0 0	invalid information element contents	Inform. Element
1 1 0	1 0 0 1	reserved for international use	
1 1 0	1 0 1 0	reserved for international use	
1 1 0	1 0 1 1	reserved for international use	
1 1 0	1 1 0 0	reserved for national use	
1 1 0	1 1 0 1	reserved for national use	
1 1 0	1 1 1 0	reserved for national use	
1 1 0	1 1 1 1	protocol error, unspecified	
1 1 1	- - - -	Interworking	
1 1 1	0 0 0 0	reserved for international use	
1 1 1	0 : : :		
1 1 1	0 1 1 1		
1 1 1	1 0 0 0	reserved for national use	
1 1 1	1 : : :		
1 1 1	1 1 1 0		
1 1 1	1 1 1 1	interworking, unspecified	

9.3.27 Measurement result number

This element is used by BTS to number, (on a channel), the measurement result messages sent to BSC. It is set to 0 at activation time of the channel. The numbering is modulo 256.

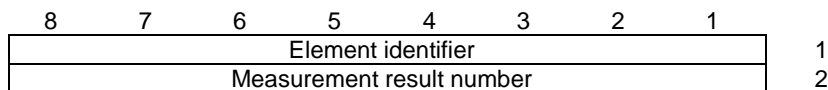

9.3.28 Message Identifier

This element is used to indicate a message type within a message.

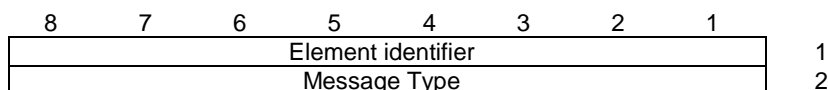

Octet 2 is coded as the Message Type information element, sub-clause 9.2.

9.3.29 SACCH Information

This element is used to carry the SACCH filling information (System Information messages, EXTENDED MEASUREMENT ORDER message or MEASUREMENT INFORMATION message) that is to be used on a specific channel. The MEASUREMENT INFORMATION message is periodically sent on SACCH.

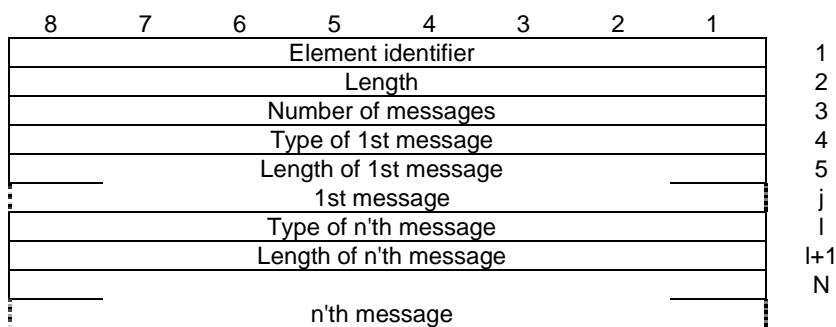

The Length field (octet 2) indicates in binary the total remaining length of the element (octets 3 - N).

The Number of SI messages field (octet 3) indicates in binary the number of messages contained in the element.

The coding of each of these messages consists of a type field (Type of n"th msg), a length field (Length of n"th message) and a message field (n"th message).

The "Type of n"th msg" field indicates the type of SYSTEM INFORMATION, or an EXTENDED MEASUREMENT ORDER message or a MEASUREMENT INFORMATION message that follows in the "n"th message" field. It is coded as follows:

Value	Message
0 0 0 0 0 1 0 1	SYSTEM INFORMATION 5
0 0 0 0 0 1 1 0	SYSTEM INFORMATION 6
0 0 0 0 1 1 0 1	SYSTEM INFORMATION 5bis
0 0 0 0 1 1 1 0	SYSTEM INFORMATION 5ter
0 1 0 0 0 1 1 1	EXTENDED MEASUREMENT ORDER
0 1 0 0 1 0 0 0	MEASUREMENT INFORMATION

All other values are reserved.

The "Length of n"th SI message" field indicates in binary the length of the "n"th message" field that follows.

The "n"th message" field contains a complete SACCH message as defined in 3GPP TS 44.018.

9.3.30 System Info Type

This element is used to indicate the type of SYSTEM INFORMATION message or an EXTENDED MEASUREMENT ORDER message or a MEASUREMENT INFORMATION message as defined in 3GPP TS 44.018.

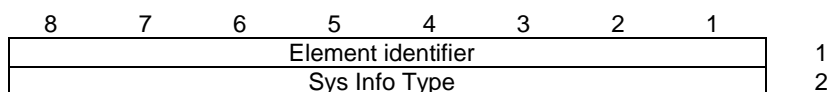

The Sys Info Field (octet 2) indicates the type of message. It is coded as follows:

Value	Message
0 0 0 0 0 0 0 0	SYSTEM INFORMATION 8
0 0 0 0 0 0 0 1	SYSTEM INFORMATION 1
0 0 0 0 0 0 1 0	SYSTEM INFORMATION 2
0 0 0 0 0 0 1 1	SYSTEM INFORMATION 3
0 0 0 0 0 1 0 0	SYSTEM INFORMATION 4
0 0 0 0 0 1 0 1	SYSTEM INFORMATION 5
0 0 0 0 0 1 1 0	SYSTEM INFORMATION 6
0 0 0 0 0 1 1 1	SYSTEM INFORMATION 7
0 0 0 0 1 0 0 0	SYSTEM INFORMATION 16
0 0 0 0 1 0 0 1	SYSTEM INFORMATION 17
0 0 0 0 1 0 1 0	SYSTEM INFORMATION 2bis
0 0 0 0 1 0 1 1	SYSTEM INFORMATION 2ter
0 0 0 0 1 1 0 1	SYSTEM INFORMATION 5bis
0 0 0 0 1 1 1 0	SYSTEM INFORMATION 5ter
0 0 0 0 1 1 1 1	SYSTEM INFORMATION 10
0 1 0 0 0 1 1 1	EXTENDED MEASUREMENT ORDER
0 1 0 0 1 0 0 0	MEASUREMENT INFORMATION
0 0 1 0 1 0 0 0	SYSTEM INFORMATION 13
0 0 1 0 1 0 0 1	SYSTEM INFORMATION 2quarter
0 0 1 0 1 0 1 0	SYSTEM INFORMATION 9
0 0 1 0 1 0 1 1	SYSTEM INFORMATION 18
0 0 1 0 1 1 0 0	SYSTEM INFORMATION 19
0 0 1 0 1 1 0 1	SYSTEM INFORMATION 20
All other values are reserved.	

9.3.31 MS Power Parameters

This element carries the parameters required by TRX for MS power control.

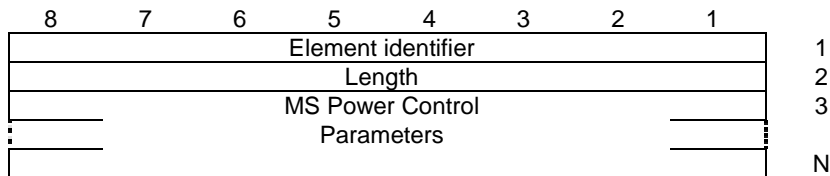

The MS Power Control Parameters field contains the parameters and limits required when MS power control is to be performed by BTS. The coding is operator dependant. Examples of possible parameters and algorithms can be found in 3GPP TS 45.008 (RXLEV, RX-QUAL-FULL, RX-QUAL-SUB, DISTANCE (Timing Advance) etc.).

9.3.32 BS Power Parameters

This element carries the parameters required by TRX for control of its own transmission power.

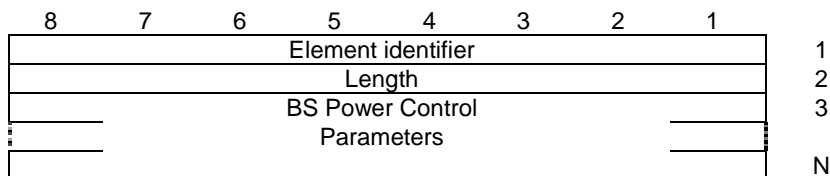

The BS Power Control Parameters field contains the parameters and limits required when TRX transmission power control is to be performed by BTS. The coding is operator dependant. Examples of possible parameters and algorithms can be found in 3GPP TS 45.008 (RXLEV, RX-QUAL-FULL, RX-QUAL-SUB, DISTANCE (Timing Advance) etc.).

9.3.33 Pre-processing Parameters

This element contains the parameters required by BTS for the pre-processing of radio measurement data.

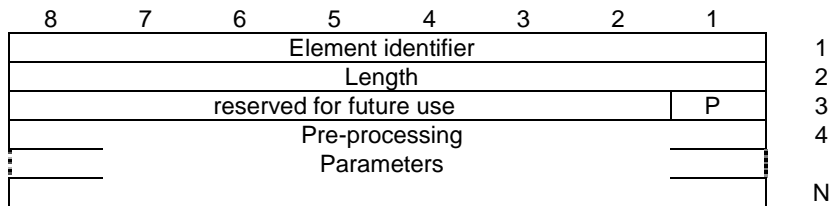

The P bit (bit 1 of octet 3) indicates whether pre-processing is to be used and it is coded as follows:

- 0 use the basic measurement reporting procedure (report raw data);
- 1 use the pre-processed measurement reporting procedure.

If pre-processing is to be used, the Pre-processing Parameters field (octets 4-N) contains the parameters required by BTS. The coding of this field is operator dependant.

9.3.34 Pre-processed Measurements

This element is used by BTS to report the results of the pre-processing of radio measurement data.

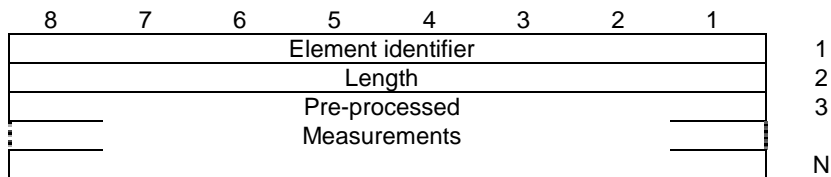

The Pre-processed Measurements field (octets 3-N) contains the results of the pre-processing in BTS. The coding of this field is operator dependant.

9.3.35 Full Immediate Assign Info

This element is used to convey a full L3 immediate assign message (3 types).

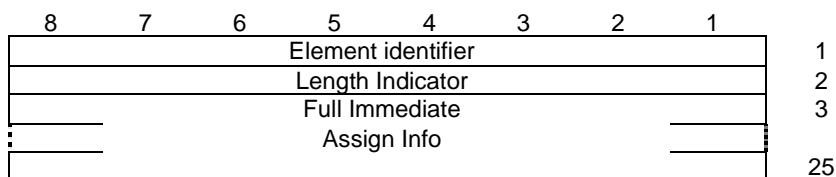

The Length Indicator field (octet 2) indicates in binary the remaining length of the element (octets 3-25).

The Full Immediate Assign Info field (octets 3-25) contains a complete immediate assign message (IMMEDIATE ASSIGNMENT or IMMEDIATE ASSIGNMENT EXTENDED or IMMEDIATE ASSIGNMENT REJECT) as defined in 3GPP TS 44.018.

9.3.36 SMSCB Information

This element is used to convey a complete frame to be broadcast on the CBCH including the Layer 2 header for the radio path.

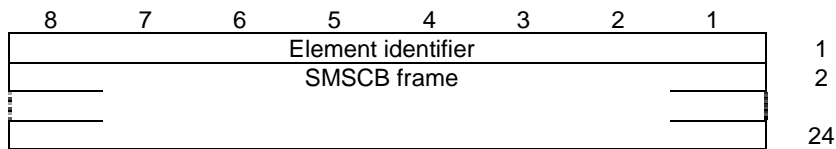

9.3.37 MS Timing Offset

The information is coded in two octets and contains the MS Timing Offset as measured by the BTS.

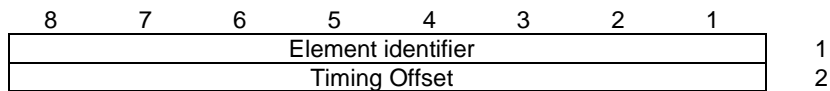

The meaning of the MS Timing Offset is as defined in 3GPP TS 45.010. The value of MS Timing Offset is the binary value of the 8-bit Timing Offset field (octet 2) - 63. The range of MS Timing Offset is therefore -63 to 192.

9.3.38 Erroneous Message

This information element is used to carry a complete A-bis interface message which was considered erroneous at reception.

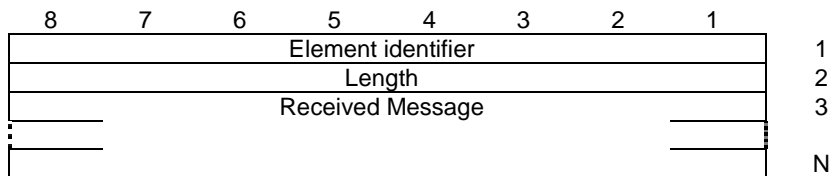

The Received Message field contains a complete A-bis interface L3 message as defined in clause 8 of this GTS, including Message Discriminator and Message Type.

9.3.39 Full BCCH Information (message name)

This information element contains a complete L3 message as specified in 3GPP TS 24.008.

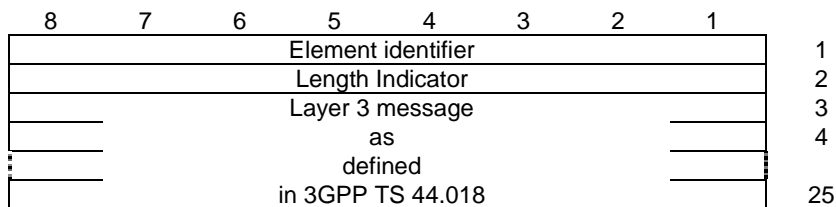

The Length Indicator field (octet 2) indicates in binary the remaining length of the element (octets 3-25). The most significant bit is bit 8 of octet 2 and the least significant bit is bit 1 of octet 2.

Octets 3-25 contain the complete L3 message as defined in 3GPP TS 44.018. In the message format sub-clause, the 3GPP TS 44.018 message name to be included is indicated within brackets.

9.3.40 Channel Needed

This information element is used to indicate to the mobile station which channel will be needed for the transaction linked to the paging procedure.

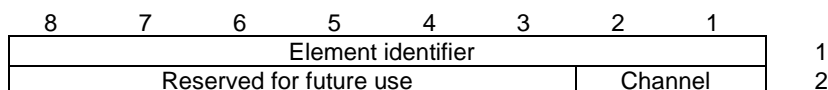

The Channel Field (bits 1-2 of octet 2) indicates the further combination of channel which will be needed. It is coded as follows:

Value	Channel Needed.
0 0	Any Channel.
0 1	SDCCH.
1 0	TCH/F (Full rate).
1 1	TCH/F or TCH/H (Dual rate).

9.3.41 CB Command type

This element is used to indicate the type of broadcast requested.

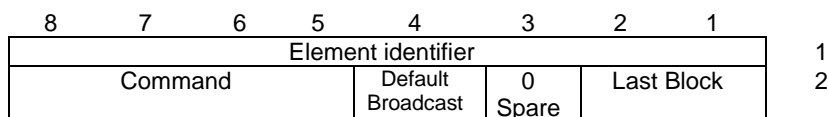

The Command Field (bits 5 to 8) indicates the command to be performed. It is coded as follows:

Value	Command
0 0 0 0	Normal message Broadcast.
1 0 0 0	Schedule message Broadcast.
1 1 1 0	Default message Broadcast.
1 1 1 1	Null message Broadcast.
All other values are reserved.	

When the Command Field is different from the value 1110 (Default message Broadcast), the BTS uses the SMSCB message IE together with the Command Field and the Last Block Field to build the blocks sent on the Radio interface, as defined by 3GPP TS 44.012. In that case bit 4 is ignored.

When the Command Field takes the value 1110 (Default message Broadcast), the BTS uses the SMSCB message IE together with the Default Broadcast Field and the Last Block Field to build the blocks sent on the Radio interface, as defined by 3GPP TS 44.012.

The Default Broadcast Field (bit 4) is coded as follows:

Value	Default message to be broadcast
0	Normal message.
1	Null message.

The BTS uses the Last Block Field to signal to the MS the last block containing useful information as defined by 3GPP TS 44.012. This Field (bits 1 and 2) is coded as follows:

Value	Last Block containing useful information
00	Block 4
01	Block 1
10	Block 2
11	Block 3

9.3.42 SMSCB Message

This element is used to convey the message to be broadcast on the CBCH.

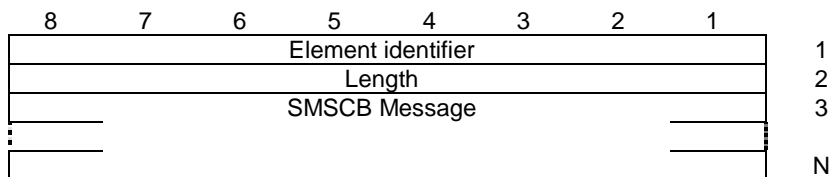

9.3.43 CBCH Load Information

This information element is used to indicate to the BSC the load situation of CBCH in the BTS.

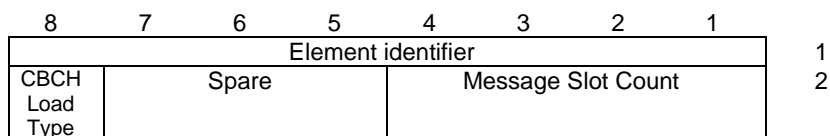

The CBCH Load Type field (bit 8 of octet 2) indicates either an underflow or an overflow situation of the CBCH in the BTS. It is coded as follows:

Value	CBCH Load Type
0	Underflow
1	Overflow

The Message Slot Count field (bits 1-4 of octet 2) indicates either the amount of SMSCB messages that are needed immediately by BTS or the amount of delay in message slots that is needed immediately by BTS depending on the value of the CBCH Load Type field. It is coded as follows:

CBCH Load Type	Message Slot Count
0	indicates the amount of SMSCB messages (1 to 15) that are needed immediately by BTS.
1	indicates the amount of delay in message slots (1 to 15) that is needed immediately by BTS.

9.3.44 SMSCB Channel Indicator

This element is used to indicate the CB channel [see 3GPP TS 45.002] to be used for broadcasting the data.

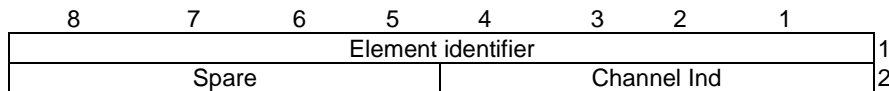

This element is used to indicate the CB channel to be used for broadcasting the data. The Channel Ind field is coded as follows:

Value	Channel Ind
0 0 0 0	Basic CBCH
0 0 0 1	Extended CBCH (supporting the extended CBCH by the network or MSs is optional)
all other values are reserved.	

9.3.45 Group call reference

It is coded as follows:

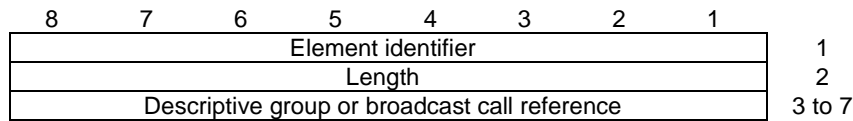

The octets 3 to 7 are coded in the same way as the octets 2 to 6 in the Descriptive group or broadcast call reference information element as defined in 3GPP TS 24.008.

9.3.46 Channel description

This is a variable length element used to pass a radio interface information element from BSC to BTS.

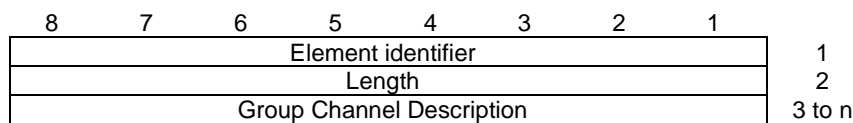

Octet j (j = 3, 4, ..., n) is the unchanged octet j-2 of a radio interface Group Channel description information element as defined in 3GPP TS 44.018, n-2 is equal to the length of the radio interface Group channel description information element.

9.3.47 NCH DRX information

This is a variable length element used to pass a radio interface information element from BSC to BTS.

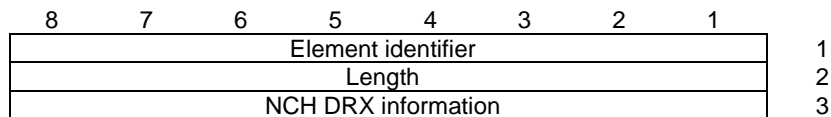

Octet 3 bits 1 and 2 are bits 1 and 2 of the radio interface NLN as defined in 3GPP TS 44.018.

Octet 3 bits 3, 4 and 5 are bits 1, 2 and 3 of the radio interface eMLPP priority as defined in 3GPP TS 44.018.

Octet 3 bit 6 is the NLN status parameter as defined in 3GPP TS 44.018.

Octet 3 bits 7 and 8 are spare and set to zero.

9.3.48 Command indicator

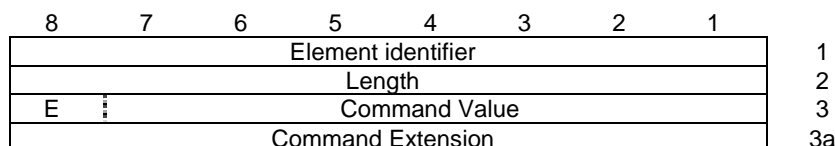

The Command Value is a single octet field (octet 3) if the extension bit E (bit 8) is set to 0. If it is set to 1 then the Command value is a 2 octet field (octets 3 and 3a).

COMMAND VALUES:

Value	Command
0 0 0 0 0 0	Start
0 0 0 0 0 1	Stop
0 0 0 0 1 0	reserved for international use
0 : : : : :	
1 0 0 0 0 0	
1 0 0 0 0 1	reserved for national use
1 : : : : :	
1 1 1 1 1 1	

9.3.49 eMLPP Priority

This Information Element contains the eMLPP priority of the call.

It is coded as follows:

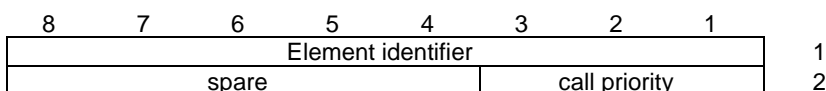

The call priority field (bit 3 to 1 of octet 2) is coded in the same way as the call priority field (bit 3 to 1 of octet 5) in the Descriptive group or broadcast call reference information element as defined in 3GPP TS 24.008.

9.3.50 UIC

It is coded as follows:

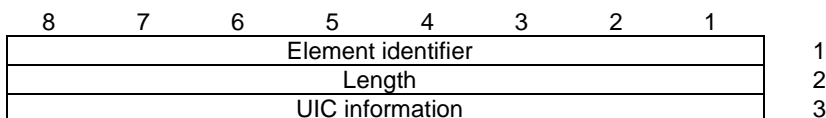

Octet 3 bits 1 to 6 contain the radio interface octet 2 bits 3 to 8 of the UIC information element as defined in 3GPP TS 44.018.

Octet 3 bits 7 and 8 are spare and set to zero.

9.3.51 Main channel reference

This element contains the main channel reference of a multislot connection.

It is coded in two octets as follows:

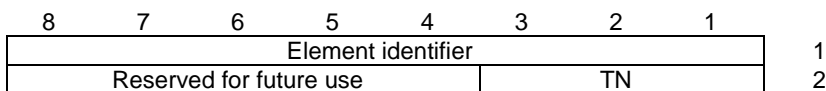

TN is time slot number, binary represented as in 3GPP TS 45.002.

9.3.52 MultiRate configuration

This element gives the description of the multirate speech codec configuration to be applied.

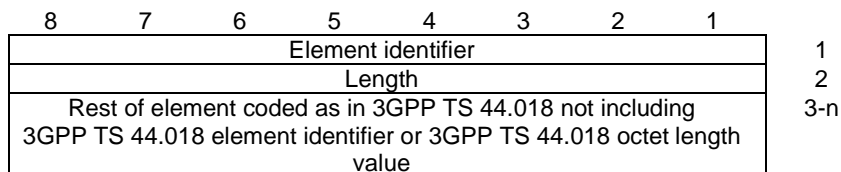

9.3.53 MultiRate Control

This element indicates whether TFO is enabled or not and whether the BSC authorises the BTS to perform autonomously multi-rate codec changes and whether an handover is to be expected.

It is coded in two octets as follows:

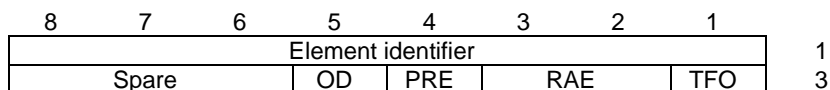

The TFO field (bit 1 of octet 3) indicates if TFO is enabled or not. It is coded as follows:

Value	TFO
0	Tandem Free Operation is enabled
1	Tandem Free Operation is disabled

The RAE field (bits 2-3, octet 3) defines whether the RATSCCH mechanism is enabled or not. It is coded as follows:

Value	RAE
0 0	RATSCCH mechanism is generally enabled, the BTS may change the AMR configuration within the given SCS and MACS constraints and within the given radio and Abis channel.
0 1	RATSCCH mechanism will potentially be enabled for one exchange. The BSC will use a MultiRate CODEC MOD REQ message for that purpose
1 0	reserved
1 1	RATSCCH mechanism is generally disabled

The PRE field (bit 4 of octet 3) indicates if an handover is to be expected soon or not. It is coded as follows:

Value	PRE
0	Handover is not expected, respectively has failed
1	Handover is expected soon

The OD field (bit 5 of octet 3) indicates if the BSC expects distant parameters or TFO Decision algorithm result from the BTS.

Value	PRE
0	The BTS shall report distant parameters
1	The BTS shall report TFO Decision algorithm result (optimised parameters).

9.3.54 Supported Codec Types

This element indicates the codec types supported by the BSS or remote BSS.

It is coded as follows:

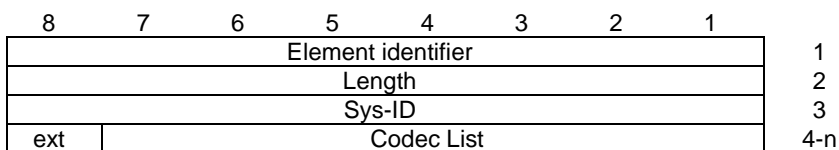

The Sys-ID field (octet 3) identifies the system that sends or has sent the configuration. It should be set to 0000 0000 for GSM.

The Codec List field (octet 4) lists the codec types that are supported by the BSS and Transcoder, and are therefore potential candidates for TFO establishment. It is coded as follows:

Bit 1:	Set to 1 if the GSM FR Speech Codec is supported.
Bit 2:	Set to 1 if the GSM HR Speech Codec is supported.
Bit 3:	Set to 1 if the GSM EFR Speech Codec is supported.
Bit 4:	Set to 1 if the GSM FR AMR Speech Codec is supported.
Bit 5:	Set to 1 if the GSM HR AMR Speech Codec is supported.
Bit 6:	Set to 1 if the UMTS AMR Speech Codec is supported.
Bit 7:	Set to 1 if the UMTS AMR 2 Speech Codec is supported.
Bit 8:	Extension bit. Set to 1 if at least one codec of Codec List extension 1 is supported, otherwise set to 0.

The Codec List extension 1 field (octet 5) lists additional codec types that are supported by the BSS and Transcoder, and are therefore potential candidates for TFO establishment. When no codec from this list is supported, then this field shall not be sent, and the extension bit of octet 4 shall be set to 0.

Bit 1:	Set to 1 if the FR AMR WB Speech Codec is supported.
Bit 2:	Set to 1 if the UMTS AMR WB Speech Codec is supported.
Bit 3:	Set to 1 if the 8PSK HR AMR Speech Codec is supported.
Bit 4:	Set to 1 if the 8PSK FR AMR WB Speech Codec is supported.
Bit 5:	Set to 1 if the 8PSK HR AMR WB Speech Codec is supported.
Bit 6-7:	Reserved, set to 0.
Bit 8:	Reserved for extension, set to 0.

If bit 4 of the Codec List field (octet 4) indicates that FR AMR is supported or if bit 5 of the Codec List field (octet 4) indicates that HR AMR is supported and bit 8 is set to 0, or if bit 6 of the Codec List field (octet 4) indicates that UMTS AMR is supported, or if bit 7 of the Codec List field (octet 4) indicates that UMTS AMR 2 is supported, or if bit 1, 3, 4 or 5 of the Codec List extension 1 field (octet 5) indicates that AMR WB is supported, the following two octets (after the Codec List field and its extensions) should be coded as follows:

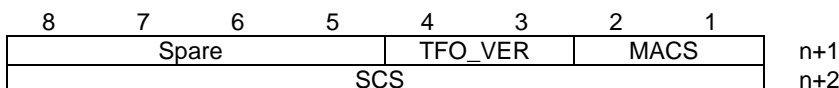

The MACS field indicates the Maximum number of AMR Codec ModeS the BSS can support in the Active Codec Set. It should be coded as follows:

0 0:	A maximum of four codec modes can be supported in the Active Codec Set
0 1:	A maximum of one codec mode can be supported in the Active Codec Set
1 0:	A maximum of two codec modes can be supported in the Active Codec Set
1 1:	A maximum of three codec modes can be supported in the Active Codec Set

The TFO_VER field indicates the TFO_VERSION.

0 0: Version 0 of TFO

All other values reserved for future use.

The SCS field indicates the Set of AMR Codec modes Supported by the BSS. It should be coded as follows for AMR FR and AMR HR:

Bit 8:	Set to 1 if the AMR 12.2 Codec Mode is supported.
Bit 7:	Set to 1 if the AMR 10.2 Codec Mode is supported.
Bit 6:	Set to 1 if the AMR 7.95 Codec Mode is supported.
Bit 5:	Set to 1 if the AMR 7.40 Codec Mode is supported.
Bit 4:	Set to 1 if the AMR 6.70 Codec Mode is supported.
Bit 3:	Set to 1 if the AMR 5.90 Codec Mode is supported.
Bit 2:	Set to 1 if the AMR 5.15 Codec Mode is supported.
Bit 1:	Set to 1 if the AMR 4.75 Codec Mode is supported.

If AMR WB is concerned, the SCS field (octets 7) is coded as follows:

Bit 6-8	Spare. Set to 0
Bit 5:	Set to 1 if the WB-AMR 23.85 Codec Mode is supported.
Bit 4:	Set to 1 if the WB-AMR 15.85 Codec Mode is supported.
Bit 3:	Set to 1 if the WB-AMR 12.65 Codec Mode is supported.
Bit 2:	Set to 1 if the WB-AMR 8.85 Codec Mode is supported.
Bit 1:	Set to 1 if the WB-AMR 6.60 Codec Mode is supported.

9.3.55 Codec Configuration

This element indicates the active codec in the BSS or the remote BSS

It is coded as follows:

8	7	6	5	4	3	2	1	
Element identifier								1
Length								2
Active Codec Type								3

The Active Codec Type field (bits 1-8, octet 3) indicates the type of codec in use. It is coded as follows:

0 0 0 0 . 0 0 0 0:	Full Rate Codec in use
0 0 0 0 . 0 0 0 1:	Half Rate Codec in use
0 0 0 0 . 0 0 1 0:	Enhanced Full Rate Codec in use
0 0 0 0 . 0 0 1 1:	FR Adaptive Multi Rate Codec in use
0 0 0 0 . 0 1 0 0:	HR Adaptive Multi Rate Codec in use
0 0 0 0 . 0 1 0 1:	UMTS Adaptive Multi Rate Codec in use
0 0 0 0 . 0 1 1 0:	UMTS Adaptive Multi Rate 2 Codec in use
0 0 0 0 . 1 0 0 1:	Full Rate Adaptive Multi-Rate WideBand Codec in use
0 0 0 0 1 0 1 0	UMTS Adaptive Multi-Rate WideBand Codec in use
0 0 0 0 1 0 1 1	8PSK Half Rate Adaptive Multi-Rate Codec in use
0 0 0 0 1 1 0 0	8PSK Full Rate Adaptive Multi-Rate WideBand Codec in use
0 0 0 0 1 1 0 1	8PSK Half Rate Adaptive Multi-Rate WideBand Codec in use
All other values are reserved for future use	

If the Active Codec Type field (octet 3) indicates that AMR (FR or HR) is the active codec type, then the following two octets (octets 4-5) shall provide the configuration in use. They shall be coded as follows:

8	7	6	5	4	3	2	1	
Spare						ICM		4
Active Codec Set								5

The ICM field (bits 1-2, octet 4) defines the Initial Codec Mode. It is coded as defined in the 3GPP TS 45.009.

The Active Codec Set (octet 5) defines the set of AMR codec modes used in the active set. It is coded as defined for the Set of AMR codec modes in the Multi-Rate configuration IE in the 3GPP TS 44.018.

If the Active Codec Type field (octet 3) indicates that AMR WB is the active codec type, then the following three octets (octets 4-6) shall provide the configuration in use. They shall be coded as follows:

8	7	6	5	4	3	2	1	
Spare						ICM		4
Active Codec Set								5
Active Codec Set								6

The ICM field (bits 1-2, octet 4) defines the Initial Codec Mode. It is coded as defined in the 3GPP TS 45.009.

The Active Codec Set (octets 5-6) defines the set of AMR codec modes used in the active set. It is coded as defined for the Set of AMR codec modes in the Multi-Rate configuration IE in the 3GPP TS 44.018.

9.3.56 Round Trip Delay

This element indicates the value of the calculated round trip delay between the BTS and the transcoder, or between the BTS and the remote BTS, if TFO is established.

It is coded in 2 octets as follows:

8	7	6	5	4	3	2	1	
Element identifier								1
RTD						Delay IND		2

The RTD field is the binary representation of the value of the round trip delay in 20 ms increments.

The Delay IND field indicates if the delay corresponds to a BTS to transcoder delay or to a BTS to remote BTS delay. It is coded as follows:

Value	Delay IND
0	The RTD field contains the BTS-Transcoder round trip delay
1	The RTD field contains the BTS-Remote BTS round trip delay

9.3.57 TFO Status

This element indicates if TFO is established. It is coded in 2 octets as follows:

8	7	6	5	4	3	2	1	
Element identifier								1
Spare						TFO		2

The TFO field shall be coded as follows:

Value	TFO
0	TFO is not established
1	TFO is established

9.3.58 LLP APDU

This is a variable length element that conveys an embedded message or message segment associated with the higher level protocol LLP, as defined in 3GPP TS 44.071. This element can be sent from the BSC to the BTS or to the Standalone Type B LMU, and vice versa.

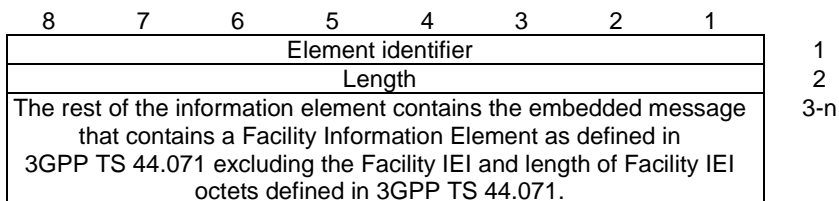

9.3.59 TFO transparent container

This is a variable length element that conveys a message associated with TFO protocol, as defined in 3GPP TS 28.062. This element can be sent from the BSC to the BTS or from the BTS to the BSC. The BTS shall retrieve the information it is able to understand, and forward transparently the complete information to the BSC or to the TRAU.

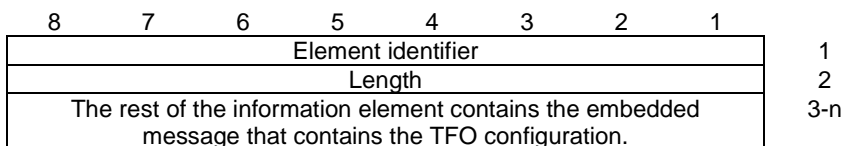

Annex A (informative): Change History

Meeting /Date	Document	CR	Rev	Subject	New Ver
September 2003		-	-	New version 6.0.0.based on version 5.6.0	6.0.0
GP-16	GP-031997	011		Editorial correction of references	6.0.0
GP-23	GP-050569	014	2	Incorrect length of group call reference IE	6.1.0
GP-23	GP-050570	017	1	Incorrect length of the eMLPP priority	6.1.0

History

Document history		
V6.1.0	January 2005	Publication