



**Electromagnetic compatibility
and radio spectrum matters (ERM);
The specification and implementation of design changes to
interrogators and specification of the test plan for
the Preliminary Tests and the Trial;
Modification of interrogators and specification of
test plans for the Preliminary Tests and Trial**

Reference

RTS/ERM-TG34-312

Keywords

DAA, ER-GSM, radio, RFID

ETSI

650 Route des Lucioles
F-06921 Sophia Antipolis Cedex - FRANCE

Tel.: +33 4 92 94 42 00 Fax: +33 4 93 65 47 16

Siret N° 348 623 562 00017 - NAF 742 C
Association à but non lucratif enregistrée à la
Sous-Préfecture de Grasse (06) N° 7803/88

Important notice

Individual copies of the present document can be downloaded from:

<http://www.etsi.org>

The present document may be made available in more than one electronic version or in print. In any case of existing or perceived difference in contents between such versions, the reference version is the Portable Document Format (PDF). In case of dispute, the reference shall be the printing on ETSI printers of the PDF version kept on a specific network drive within ETSI Secretariat.

Users of the present document should be aware that the document may be subject to revision or change of status. Information on the current status of this and other ETSI documents is available at

<http://portal.etsi.org/tb/status/status.asp>

If you find errors in the present document, please send your comment to one of the following services:

http://portal.etsi.org/chaicor/ETSI_support.fffasp

Copyright Notification

No part may be reproduced except as authorized by written permission.
The copyright and the foregoing restriction extend to reproduction in all media.

© European Telecommunications Standards Institute 2013.
All rights reserved.

DECT™, PLUGTESTS™, UMTS™ and the ETSI logo are Trade Marks of ETSI registered for the benefit of its Members.
3GPP™ and LTE™ are Trade Marks of ETSI registered for the benefit of its Members and
of the 3GPP Organizational Partners.
GSM® and the GSM logo are Trade Marks registered and owned by the GSM Association.

Contents

Intellectual Property Rights	4
Foreword.....	4
Introduction	4
1 Scope	5
2 References	5
2.1 Normative references	5
2.2 Informative references.....	5
3 Definitions, symbols and abbreviations	6
3.1 Definitions	6
3.2 Symbols.....	6
3.3 Abbreviations	6
4 Background Information	7
5 RFID Interrogator modifications.....	7
5.1 System concept.....	7
5.2 Hardware modifications	7
5.2.1 RFID specific.....	7
5.2.2 Railways specific	8
5.3 Software modifications.....	9
6 RFID Interrogator acceptance test.....	9
6.1 RFID standards.....	9
6.2 ETSI standards	9
6.3 (E)R-GSM mitigation tests.....	9
6.3.1 (E)R-GSM detection and decoding.....	9
6.3.2 Detection at start-up of interrogator.....	9
6.3.3 Detection at start-up of (E)R-GSM BTS.....	10
6.4 Acceptance test results	10
Annex A (informative): UHF RFID Interrogator modification description	11
Annex B (informative): UHF RFID Interrogator acceptance test results.....	15
B.1 Introduction	15
B.2 RFID standards.....	15
B.3 ETSI standards	17
B.3.1 Interrogator spectrum mask	17
B.3.2 Tag spectrum mask.....	22
B.4 (E)R-GSM mitigation tests.....	25
B.4.1 (E)R-GSM detection and decoding	25
B.4.2 Detection at start-up of interrogator	26
B.4.3 Detection at start-up of (E)R-GSM BTS	28
Annex C (informative): Bibliography.....	31
History	32

Intellectual Property Rights

IPRs essential or potentially essential to the present document may have been declared to ETSI. The information pertaining to these essential IPRs, if any, is publicly available for **ETSI members and non-members**, and can be found in ETSI SR 000 314: "*Intellectual Property Rights (IPRs); Essential, or potentially Essential, IPRs notified to ETSI in respect of ETSI standards*", which is available from the ETSI Secretariat. Latest updates are available on the ETSI Web server (<http://ipr.etsi.org>).

Pursuant to the ETSI IPR Policy, no investigation, including IPR searches, has been carried out by ETSI. No guarantee can be given as to the existence of other IPRs not referenced in ETSI SR 000 314 (or the updates on the ETSI Web server) which are, or may be, or may become, essential to the present document.

Foreword

This Technical Specification (TS) has been produced by ETSI Technical Committee Electromagnetic compatibility and Radio spectrum Matters (ERM).

Introduction

In order to accommodate the spectrum needs for the increasing number of RFID devices and systems, an extension band for high power RFID systems in the range between 915 MHz and 921 MHz has been requested. This band is already used by RFID in several countries worldwide and its designation in Europe would increase its functionality and simplify the international movement of goods using RFID identification systems. In Europe, a part of this new frequency band has to be shared between the primary user ER-GSM and RFID. In order to guarantee an interference-free coexistence between the two systems, mechanisms have to be implemented by RFID systems to reduce the probability of interference to an acceptable minimum. These techniques can be either of regulatory, technical or operational nature.

The present document includes a description of the modifications made to the hardware and software of two UHF RFID interrogators in order to implement demonstrators with the Detect And Avoid (DAA) technique defined in TS 102 902 [i.1] and TS 102 903 [i.2]. In addition a specification of acceptance tests for the modified interrogators is provided.

1 Scope

The present document specifies the practical implementation of the DAA mitigation technique for UHF RFID systems sharing the band 918 MHz to 921 MHz with ER-GSM. It covers the required modifications to UHF RFID interrogators as well as the subsequent acceptance tests. The purpose of the modified interrogators, (also called demonstrators) is to validate a subset of the mitigation techniques specified in [i.1] and [i.2]. The present document only covers the design modification and acceptance tests.

The system tests carried out together with ER-GSM will be covered in TR 101 602 [i.7].

2 References

References are either specific (identified by date of publication and/or edition number or version number) or non-specific. For specific references, only the cited version applies. For non-specific references, the latest version of the referenced document (including any amendments) applies.

Referenced documents which are not found to be publicly available in the expected location might be found at <http://docbox.etsi.org/Reference>.

NOTE: While any hyperlinks included in this clause were valid at the time of publication ETSI cannot guarantee their long term validity.

2.1 Normative references

The following referenced documents are necessary for the application of the present document.

- [1] ETSI EN 302 208 (V1.4.1): "Electromagnetic compatibility and Radio spectrum Matters (ERM); Radio Frequency Identification Equipment operating in the band 865 MHz to 868 MHz with power levels up to 2 W".

2.2 Informative references

The following referenced documents are not necessary for the application of the present document but they assist the user with regard to a particular subject area.

- [i.1] ETSI TS 102 902: "Electromagnetic compatibility and radio spectrum matters (ERM); Methods, parameters and test procedures for cognitive interference mitigation towards ER-GSM for use by UHF RFID using Detect-And-Avoid (DAA) or other similar techniques".
- [i.2] ETSI TS 102 903: "Electromagnetic compatibility and Radio spectrum Matters (ERM); Compliance tests for cognitive interference mitigation for use by UHF RFID using Detect-And-Avoid (DAA) or other similar techniques".
- [i.3] EIRENE System Requirements Specification Version 15.1.
- [i.4] ETSI TS 144 018: "Digital cellular telecommunications system (Phase 2+); Mobile radio interface layer 3 specification; Radio Resource Control (RRC) protocol (3GPP TS 44.018 version 10.6.0 Release 10)".
- [i.5] ETSI TR 102 649-2: "Electromagnetic compatibility and Radio spectrum Matters (ERM); Technical characteristics of Short Range Devices (SRD) and RFID in the UHF Band; System Reference Document for Radio Frequency Identification (RFID) and SRD equipment; Part 2: Additional spectrum requirements for UHF RFID, non-specific SRDs and specific SRDs".
- [i.6] ISO/IEC 18000-6:2010: "Information technology -- Radio frequency identification for item management -- Part 6: Parameters for air interface communications at 860 MHz to 960 MHz".

- [i.7] ETSI TR 101 602: "Electromagnetic compatibility and Radio spectrum Matters (ERM); Technical Report on Preliminary Tests and Trial to verify mitigation techniques for sharing spectrum between RFID and ER-GSM".

3 Definitions, symbols and abbreviations

3.1 Definitions

For the purposes of the present document, the following terms and definitions apply:

Detect And Avoid (DAA): technique to protect radio communication services by avoiding co-channel operation.

NOTE: Before transmitting, a system senses the channel within its operational bandwidth in order to detect the possible presence of other systems. If a channel is occupied, the system avoids transmission on this channel until it becomes available.

Downlink (DL): direction of communication from master to slave, where in the case of a typical RFID system the direction flows from the interrogator to tag

fixed: physically fixed, non- moving device; includes temporary installations as well

Listen Before Talk (LBT): spectrum access protocol requiring a cognitive radio to perform spectrum sensing before transmitting

location awareness: capability that allows a device to determine its location to a defined level of precision

mobile: physically moving device

Uplink (UL): direction of communication from Slave to Master

3.2 Symbols

For the purposes of the present document, the following symbols apply:

dB	decibel
f	frequency measured under normal test conditions

3.3 Abbreviations

For the purposes of the present document, the following abbreviations apply:

ARFCN	Absolute Radio Frequency Channel Number
BCCH	Broadcast Control CHannel
BLF	Backscatter-Link Frequency
BTS	Base Transceiver Station
DAA	Detect And Avoid
DL	DownLink
e.r.p.	effective radiated power
ECC	Electronic Communications Committee
EEPROM	Electrically Erasable and Programmable Read Only Memory
EIRENE	European Integrated Railway Radio Enhanced Network
ER-GSM	Extended Railways GSM
GSM	Global System for Mobile communication
GSM-R	GSM - Railway
IE	Information Element
LBT	Listen Before Talk
M	Number of subcarrier cycles per symbol
RFID	Radio Frequency IDentification
R-GSM	Railways Global System for Mobile communications

Tari	Reference time interval for a data-0 in Interrogator-to-tag signalling
TCH	Traffic CHannel
TX	Transmitter
UHF	Ultra High Frequency
UL	UpLink

4 Background Information

The present document specifies the requirements for test interrogators (demonstrators) as needed for validation of the successful co-existence of RFID with ER-GSM when operating in the same frequency band. The railways require a comprehensive trial of the mitigation technique before giving their formal agreement for RFID to share the band with ER-GSM. A successful outcome to the trial will also assist ECC in recommending the designation of additional spectrum for RFID at UHF.

The European Commission has identified RFID as a technology that can bring fundamental improvements to the Community. This is not only in terms of improvements to the efficiency of business but also in terms of the quality of people's lives. Already RFID is being adopted at an increasing rate across a wide range of applications. For example in 2010 global sales of RFID tags at UHF grew to 1,2 billion (see note), which is 73 % higher than market predictions. By 2022 it is estimated that the global annual consumption of tags at UHF will have reached 86 billion (see note).

NOTE: Source IDTechEx.

To make provision for this growth in demand, in 2008 ETSI submitted a request to ECC for additional spectrum at UHF for RFID. Details of this request are described in SRDoc TR 102 649-2 [i.5]. The document identified that the frequency range 915 MHz to 921 MHz, which acts as a guard band between the uplink and downlink for GSM, was substantially unused. ECC was asked to consider whether this band could be designated for use by RFID.

Not long afterwards the railways requested the extension of the GSM-R band to include the frequency range 918 MHz to 921 MHz paired with 873 MHz to 876 MHz. The ECC agreed to this request. In subsequent discussions between the railways and ERM_TG34, the railways agreed to share the band with RFID systems with one obligation, RFID community has to provide reliable techniques to ensure GSM-R operation without causing harmful interferences.

5 RFID Interrogator modifications

5.1 System concept

The RFID interrogators to be used as demonstrators should be developed to support downlink detection of the R-GSM or ER-GSM signal. The downlink detection may be done by use of an external receiver, or the RFID receiver, which also detects the tag responses. The antenna could be a dedicated antenna to receive the R-GSM/ER-GSM transmissions, or instead one or more of the RFID antennas may be used.

The demonstrators shall support the data rates and subcarriers intended for the 400 kHz RFID TX channels and the 1 200 kHz channel spacing.

5.2 Hardware modifications

5.2.1 RFID specific

The demonstrators shall support at least the combinations of forward and return link settings as specified in Table 1.

Table 1: Forward and return link settings

Forward link	Return link
Tari \leq 10 μ s (towards 6,25 μ s)	M=4, BLF = 320 kHz
Tari \leq 10 μ s (towards 6,25 μ s)	M=4, BLF = 640 kHz

The demonstrators shall support the following transmit channels as in Table 2.

Table 2: Forward and return link settings

Frequency/MHz	Comment
916,3	See note 1
917,5	See note 1
918,7	See note 1
919,9	See note 1
919,3	See note 2
920,5	See note 2
921,7	See note 2
922,9	See note 2

NOTE 1: For use if ER-GSM band is supported by railways test equipment.
 NOTE 2: For use if ER-GSM band is not supported by railways test equipment and instead the channel frequencies have to be shifted by 3 MHz to be able to use R-GSM equipment.

5.2.2 Railways specific

Each demonstrator shall have means to detect BCCH channels in the R-GSM band and ER-GSM band.

The demonstrator shall be capable of scanning the (E)R-GSM downlink band and receive signals from the BCCH channel in the whole (E)R-GSM band. The demonstrator shall successfully receive and decode the BCCH transmission of each carrier identified in that spectrum. The message of relevance within the Broadcast Channel is the SYSTEM INFORMATION TYPE 1 (see clause 9.1.31 of TS 144 018 [i.4]) message containing the Cell Channel Description IE.

From the received information corresponding to the BCCH Cell Channel Description IE, the demonstrators shall create a list of all ARFCN used by (E)R-GSM in the local area of operation.

The detection of the BCCH information shall be possible down to -98 dBm, which is the minimum coverage power level specified for non-high speed railways tracks (see [i.3]).

The demonstrator shall not use any of the RFID TX channels with a centre frequency of less than 700 kHz away from the centre frequency of any channel stored in the ARFCN list, if the received GSM-R power level is \geq -98 dBm.

Figure 1 shows which ER-GSM channels prevent the use of either the 918,7 MHz or the 919,9 MHz RFID TX channel.

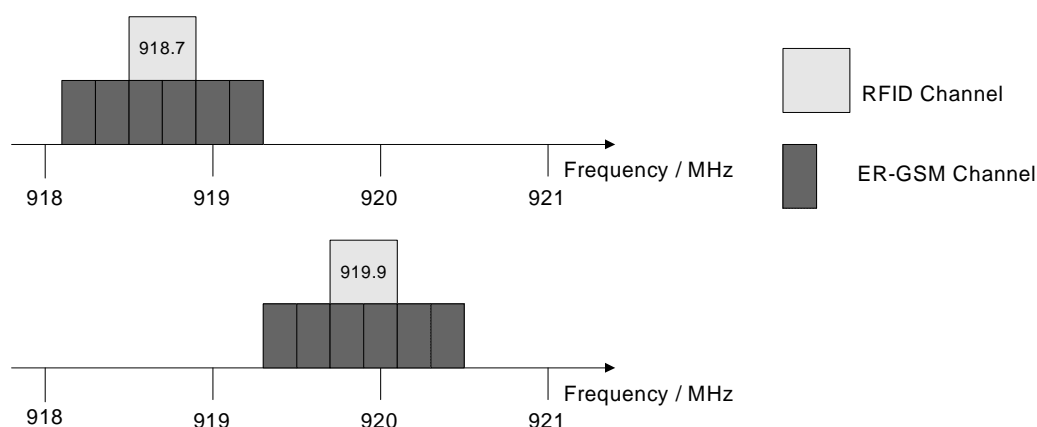

Figure 1: Illustration of interference between ER-GSM and RFID channels

Each demonstrator shall perform the BCCH and TCH detection routine after turn-on and thereafter at selectable intervals \leq 60 seconds.

NOTE: As a detection interval of 24 hour interval is not applicable for testing purposes, 60 seconds have been selected instead.

5.3 Software modifications

Each demonstrator shall provide the means to select or deselect any channel from Table 2. This is required in order to switch between R-GSM and ER-GSM band tests, as well as to emulate that certain channels are not available.

Furthermore, the demonstrator shall implement the detection period as in clause 5.2.2.

6 RFID Interrogator acceptance test

6.1 RFID standards

The demonstrator shall fulfil ISO/IEC 18000-6:2010 [i.6] Type C as far as required for these tests.

In particular the following parameters will be verified as specified in clause 5.2.1:

- Tari
- M
- BLF

6.2 ETSI standards

Based on the principle test methods of EN 302 208 [1] the following items shall be tested as specified in SRDoc TR 102 649-2 [i.5]:

- Interrogator spectrum mask (EN 302 208-1 (V1.4.1) [1], clauses 8.3, 8.4 and 8.5; SRDoc TR 102 649-2 [i.5], clauses 7.2.2 and B.1.3).
- Tag spectrum mask (EN 302 208-1 (V1.4.1) [1], clause 10; SRDoc TR 102 649-2 [i.5], clauses 7.2.2 and B.1.3).

6.3 (E)R-GSM mitigation tests

This clause defines the requirements for a RFID interrogator operating in the ER-GSM band to prove its capabilities to detect and identify a BCCH channel and to respond as required in clause 5.2.2.

6.3.1 (E)R-GSM detection and decoding

This test is to show the interrogator's capability to receive and to decode a transmitted (E)R-GSM BCCH properly. It shall be repeated for three different GSM-R received signal levels (-60 dBm, -85 dBm and -98 dBm) and at least three different ARFCNs. The test interrogator shall store the ARFCN channels and present the resulting channel list via a serial terminal or as text file. The test passes if the TCHs reported match those transmitted in the Cell Channel Description IE and the interrogator stops transmitting in the channels overlapping with ER-GSM.

6.3.2 Detection at start-up of interrogator

This test shall be done to confirm that the interrogator does detect ER-GSM channels at start-up of the interrogator.

For this test a channel in the ER-GSM band shall be allocated for railway use. After turning on the interrogator it shall report the used ER-GSM channels for railways within 60 seconds and furthermore will have demonstrated that the relevant RFID channel has been removed from the RFID channel select list.

This test shall be repeated 5 times for each of the three different GSM-R received signal levels -60 dBm, -85 dBm and -98 dBm and the test passes if the interrogator correctly reports the ER-GSM channels allocated for railway use and avoids them accordingly.

6.3.3 Detection at start-up of (E)R-GSM BTS

This test shall be done to confirm that the interrogator does detect ER-GSM channels at start-up of a GSM-R BTS.

For this test an interrogator shall be running and a BTS signal shall be turned on with a channel in the ER-GSM band allocated for railway use. After turning on the BTS the interrogator shall report the used ER-GSM channels for railways within 60 seconds and furthermore will have demonstrated that the relevant RFID channel has been removed from the RFID channel select list.

This test shall be repeated 5 times for of each of the three different GSM-R received signal levels -60 dBm, -85 dBm and -98 dBm and the test passes if the interrogator correctly reports the ER-GSM channels allocated for railway use and avoids them accordingly.

6.4 Acceptance test results

On completion of the acceptance tests, the results will be added in annex B as a revision of the present document.

Annex A (informative): UHF RFID Interrogator modification description

The demonstrator consists of two essential components. These are the modified interrogator with its connected antenna and the GSM-R Detector.

The GSM-R Detector is connected to the interrogator via its USB Host Interface. The detector is an external GSM device which scans for the presence of BCCH and TCH signals within the dedicated frequency band. The detected signals and power levels are transmitted to the interrogator via its USB Host interface. The interrogator detects and analyses the received information and decides whether a channel is available or not.

Further the interrogator is connected to a PC which is used as monitoring device. Via the serial RS232 interface all internal processes can be displayed by means of a console program like Terra-term or the Windows Hyper Terminal. The detected GSM-R channels and the detected power levels are sent via the TCP/IP Interface. These can be displayed by the PC with a Visualization Software. The PC is just used for demonstration purposes and is not essential for the operation of the interrogator.

Figure A.1 gives a quick overview on the general arrangement of the components and the cabling.

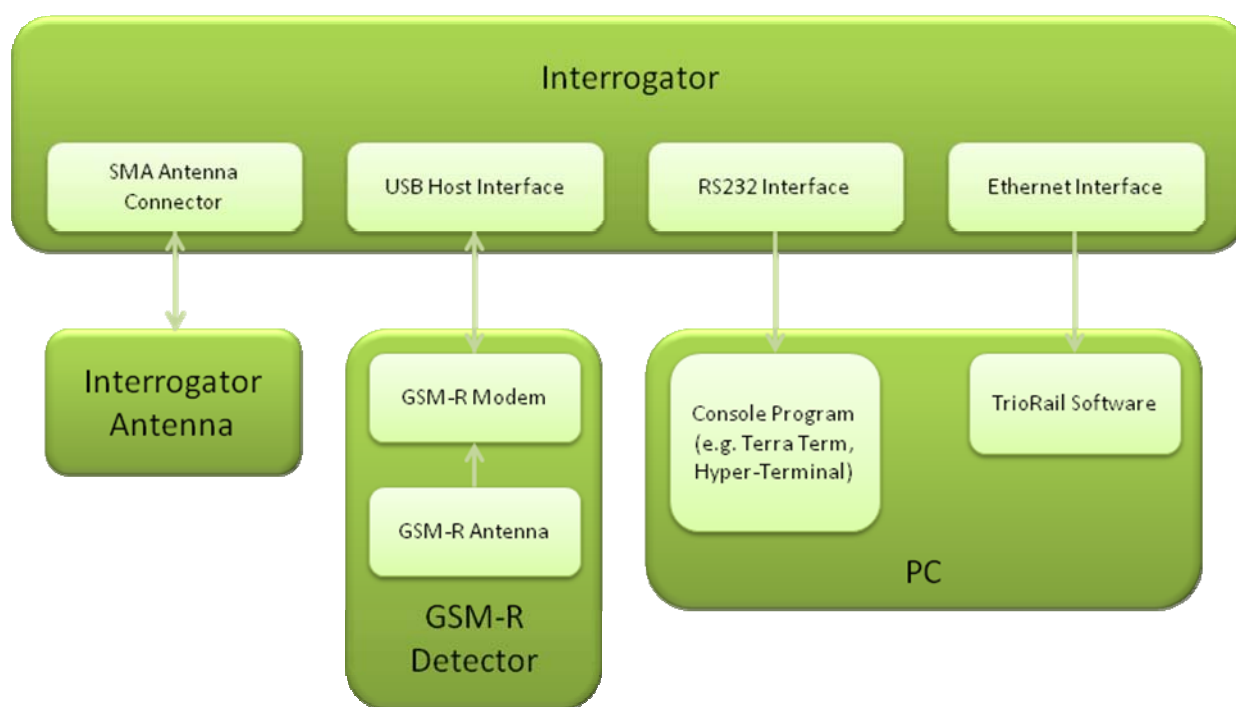

Figure A.1: Schematic of the demonstrator setup

The following clauses will give an overview on the procedures and structure inside the interrogator. The interrogator can be divided into 4 different blocks as shown in Figure A.2.

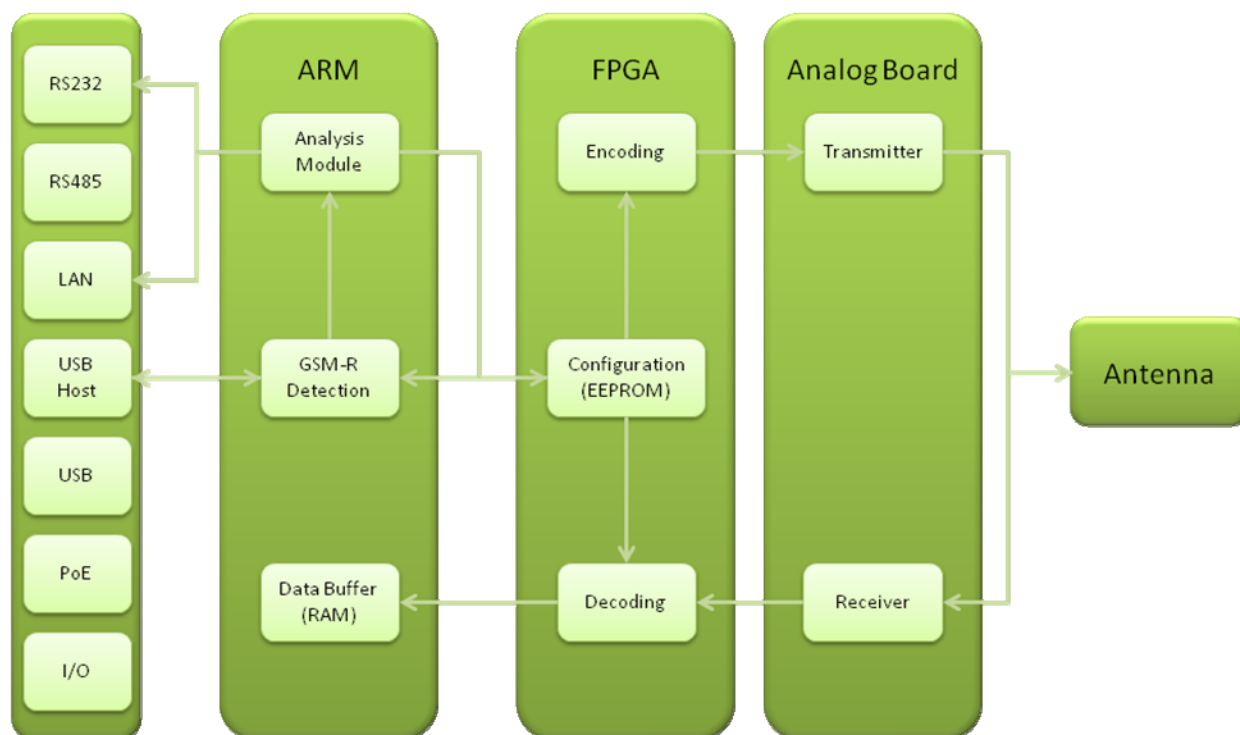

Figure A.2: Block diagram of the interrogator

The first block comprises the different interfaces and I/Os. These are responsible for the communication with a Host System, Application Software and external devices like the GSM-R Module.

Further there are two main controllers inside the reader. These are an ARM controller and a FPGA. The ARM controller is a 400 MHz processor with 64 MB RAM and 256 MB Flash memory. A Linux System (Kernel™ 3.0) runs on the controller and offers the possibility to program an application running directly on the interrogator. This feature was also used during the development of the demonstrator.

The external GSM-R Module is connected via the USB Host Interface to the interrogator. For communication and data exchange with the external detector, a GSM-R detection module was built on the ARM controller. This one has included the USB drivers for Linux of the detector and configures the detection module and provides the information which AFRCN needs to be scanned. This information is read out in advance from the reader configuration. Furthermore the detection module manages the receipt of the scanned data and forwards it to an analysis module.

The analysis module analyses the received data and controls the configuration and operation of the reader. After power up it monitors the detection process before the RF-field is switched on. During operation it reacts to changing conditions. According to the measured and analysed results it controls the reader configuration and activates or de-activates communication channels. Further it offers the possibility to display the different states and the received data from the detector. The detected AFRCN channels and their measured channel power are transmitted by the Ethernet Interface to a defined IP Address. This information can be displayed by the Visualization software. Internal process data is transmitted via the RS232 interface and can be displayed by a console tool like Terra Term or the Windows Hyper Terminal. It gives information about the boot status of the interrogator. It further shows the progress of the scan after power up and displays the detected BCCH and TCH signals. Decisions and actions (activation and de-activation of channels) based on the results are also displayed.

The FPGA reads out the configuration from the EEPROM. According to the configuration parameters it performs the encoding and decoding of the RF signals. It also controls the correct setup of the transmit and receive filter of the analogue board. The modifications performed with respect to the FPGA are explained below in detail.

For the transmit path of the interrogator the following procedure is applicable. The analysis module indicates the available transmit channels and writes them in the corresponding configuration register of the EEPROM. The FPGA reads out the configuration block and generates the base band signal. The information about the Tari value is also required. The FPGA had to be modified in way that the smaller Tari values (down to 6,25 μ s) are supported as well. This is of importance for generation of the base band signal as well as for the setup of the transmit filter on the antilog board. Smaller Tari values allow a higher data rate in the forward link and faster communication with the transponder. For the demonstrator a Tari value of 8 μ s is used which equals a forward link frequency of 125 kHz. In order to implement the revised Tari values, it was necessary to program the new channel plan into the FPGA. This, together with the information about available transmit channels, is of importance for the control of the mixer. The mixer combines the base band signal and the carrier to the transmit signal. It is controlled by the FPGA, which decides the transmit channel. Finally the transmit signal is amplified and radiated by the antenna.

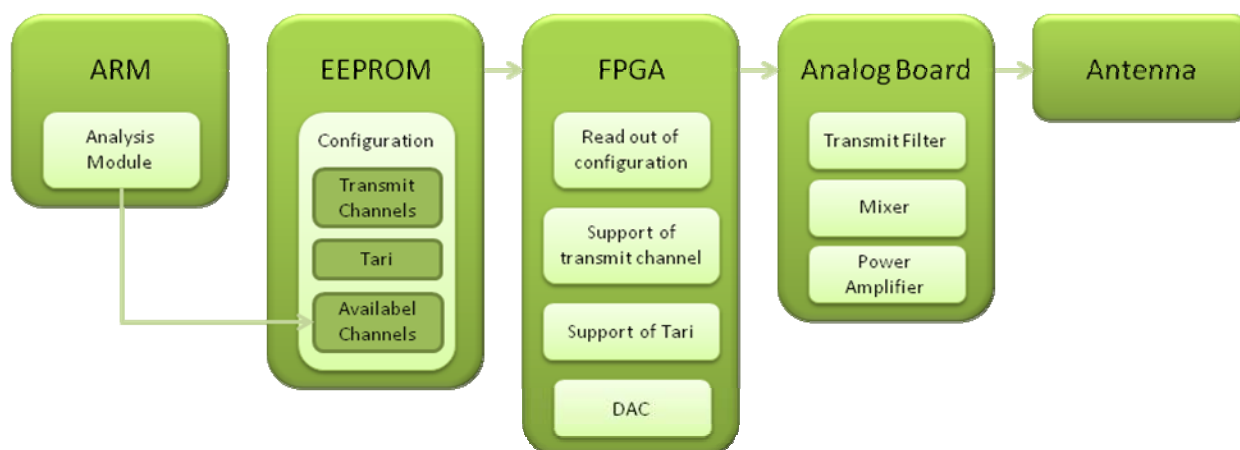

Figure A.3: Block Diagram Transmission

For the return link the response from the transponder is received by the antenna. The analogue board performs the demodulation of the signal and the filtering. The bandpass filter of the I- and Q- Channel are controlled by the FPGA. They are set in accordance to the configured Return Link Bitrate. For the demonstrator a Return Link Bitrate of 640 kHz is used. In the next step the FPGA manages the Analogue to Digital conversion of the received signal. The data is decoded. Datasets including all requested information, e.g. EPC, Timestamp, Antenna Number, ... are generated and stored in the internal data buffer of the demonstrator. The ARM controller can send this information to a defined destination. As an alternative the datasets could also be stored in the internal buffer until the information is requested by a Host System.

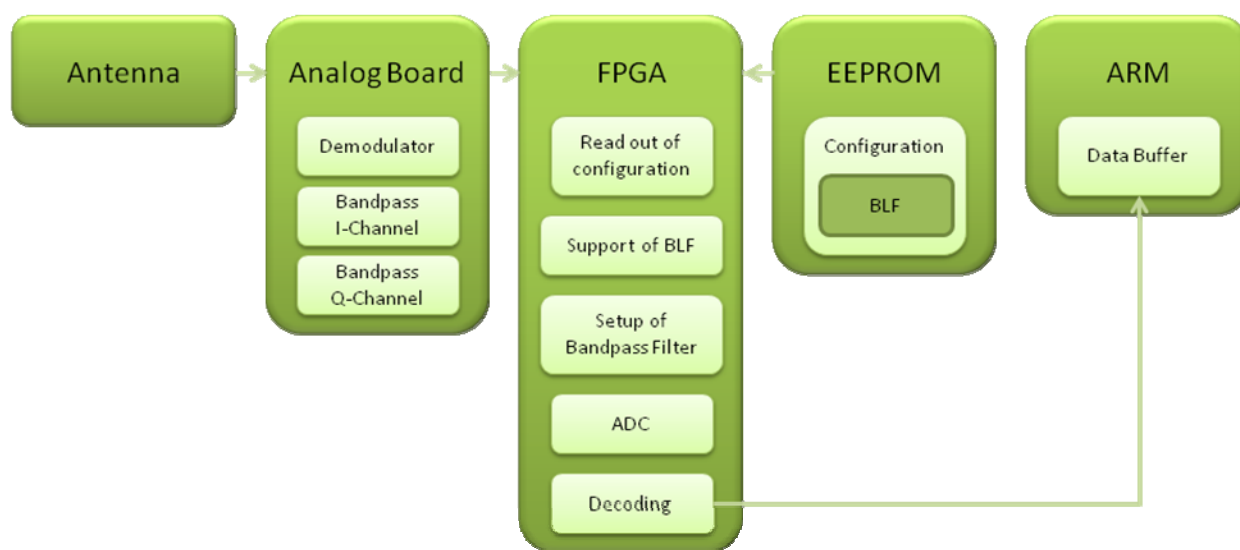

Figure A.4: Block Diagram Receive

Table A.1 summarizes the modifications done in the interrogator to become the demonstrator as shown in Figure A.5.

Table A.1: Summary of modifications compared to current interrogators on the market

Performed modifications
Implementation of new channel plan
Implementation of new Tari value (~ 8 μ s)
Adaption of the transmit filter
Implementation of higher return link subcarrier (640 kHz)
Adaption of receive filters
Development of GSM-R Detection Module
Implementation of USB driver for GSM-R Detector
Development of Analysis Module
Adaption of interrogator configuration to setup the detection process
Development of possibility for external monitoring of measured data and interrogator status

**Figure A.5: Modified Feig OBID i—scan® UHF reader (top) with Triorail GSM-R receiver (bottom)**

Annex B (informative): UHF RFID Interrogator acceptance test results

B.1 Introduction

This clause contains the results of the acceptance tests on the test interrogators / demonstrators as described in clause 6. The test interrogators / demonstrators were modified according to the requirements in clause 5 and as described in annex A.

B.2 RFID standards

Figure B.1 shows the Tari measurement. With a measured Tari = 8 μ s the requirement of Tari \leq 10 μ s is fulfilled. A Tari = 8,125 μ s means a forward link data rate of around 125 kHz.

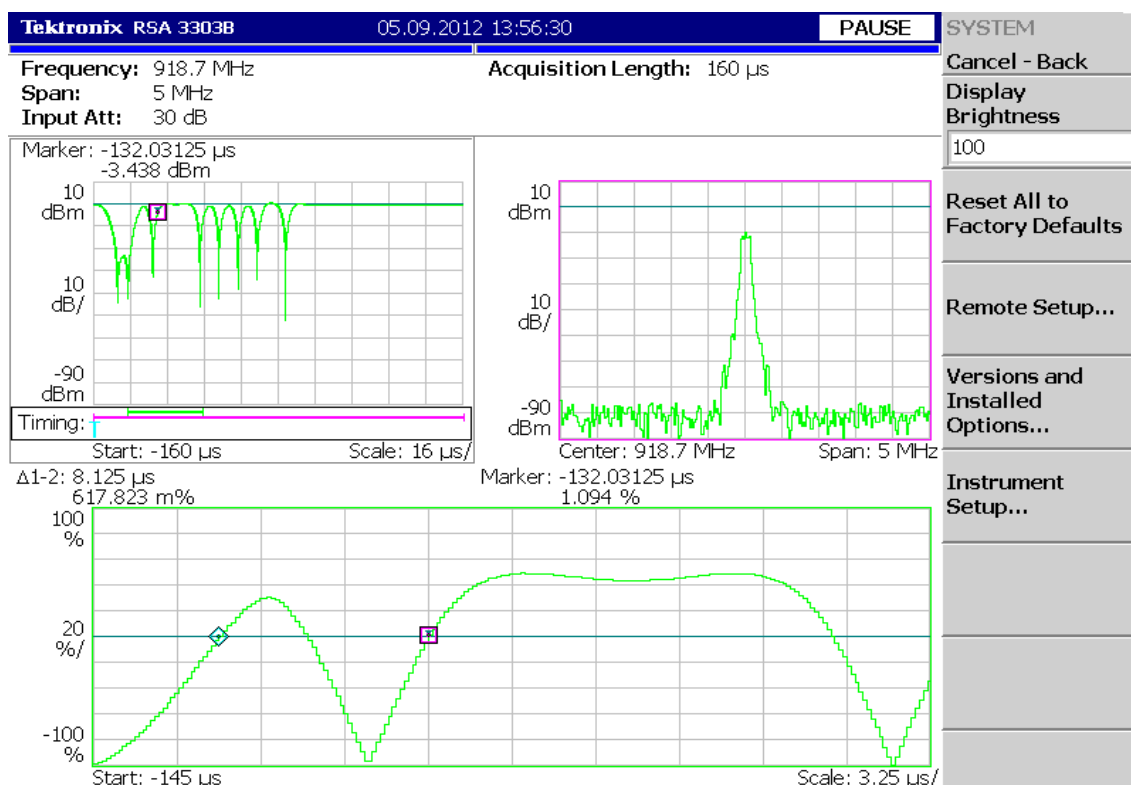

Figure B.1: Tari measurement

Figure B.2 shows that the measurement of the Modified Miller factor $M=4$, which fulfils the requirement.

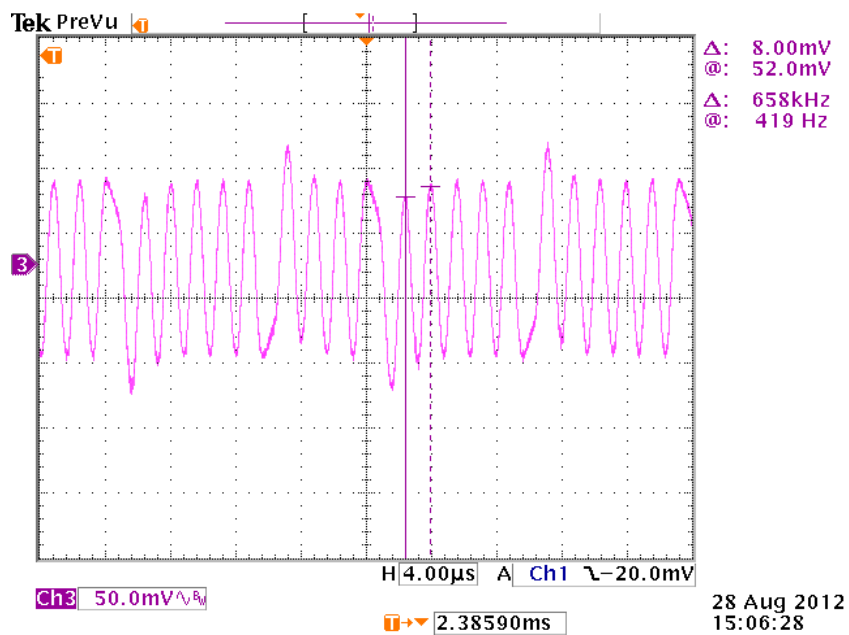

Figure B.2: Modified Miller factor (M) measurement

Figure B.3 shows that measurement of the BLF = 640 kHz, which fulfils the requirement.

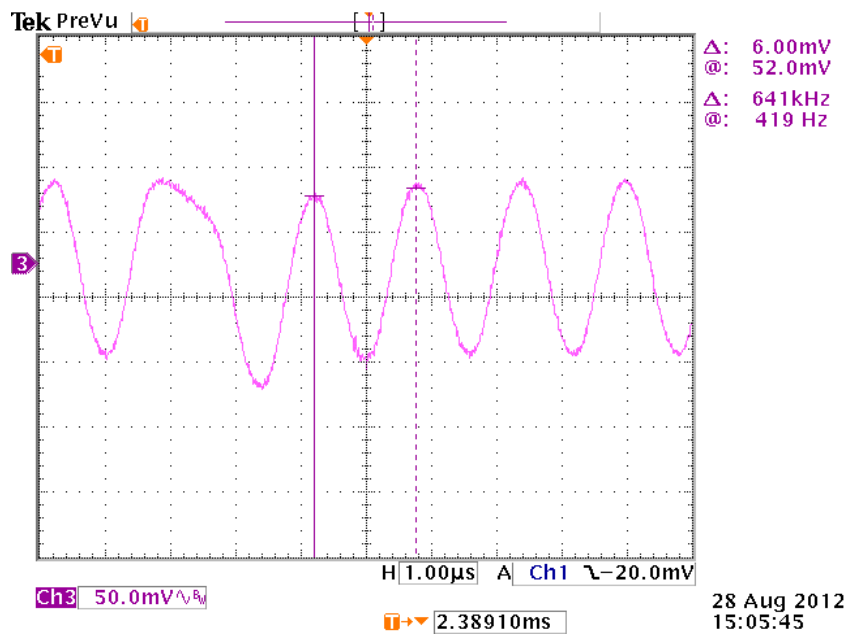

Figure B.3: Backscatter link frequency (BLF) measurement

B.3 ETSI standards

B.3.1 Interrogator spectrum mask

The Demonstrator was configured to transmit with a frequency of 918,7 MHz and a power level of 36 dBm. The Tari value was set to 8 μ s which is equal to a forward link bitrate of 125 kHz.

Figure B.4 shows the used test setup for the measurement of the transmit spectrum mask.



Figure B.4: Test Setup for Measurement of the Transmitter Spectrum Mask

A Rhode & Schwarz type FSP3 spectrum analyser was used as measuring receiver. The analyser was configured as follows:

- Centre Frequency 918,7 MHz
- Resolution bandwidth: 1 kHz
- Video bandwidth: Equal to the RBW
- Sweep Time: AUTO
- Span: 2 MHz
- Trace mode Max. hold sufficient to capture all emissions
- Detection mode Averaging

The reference level offset was configured so that the un-modulated carrier of the Demonstrator was at a level of 36 dBm. This made it necessary to compensate for the attenuation of the RF cable and the 10 dB attenuator. This was achieved by configuring a reference level offset of 10,5 dB.

Figure B.5 shows the result of the calibration of the reference level.

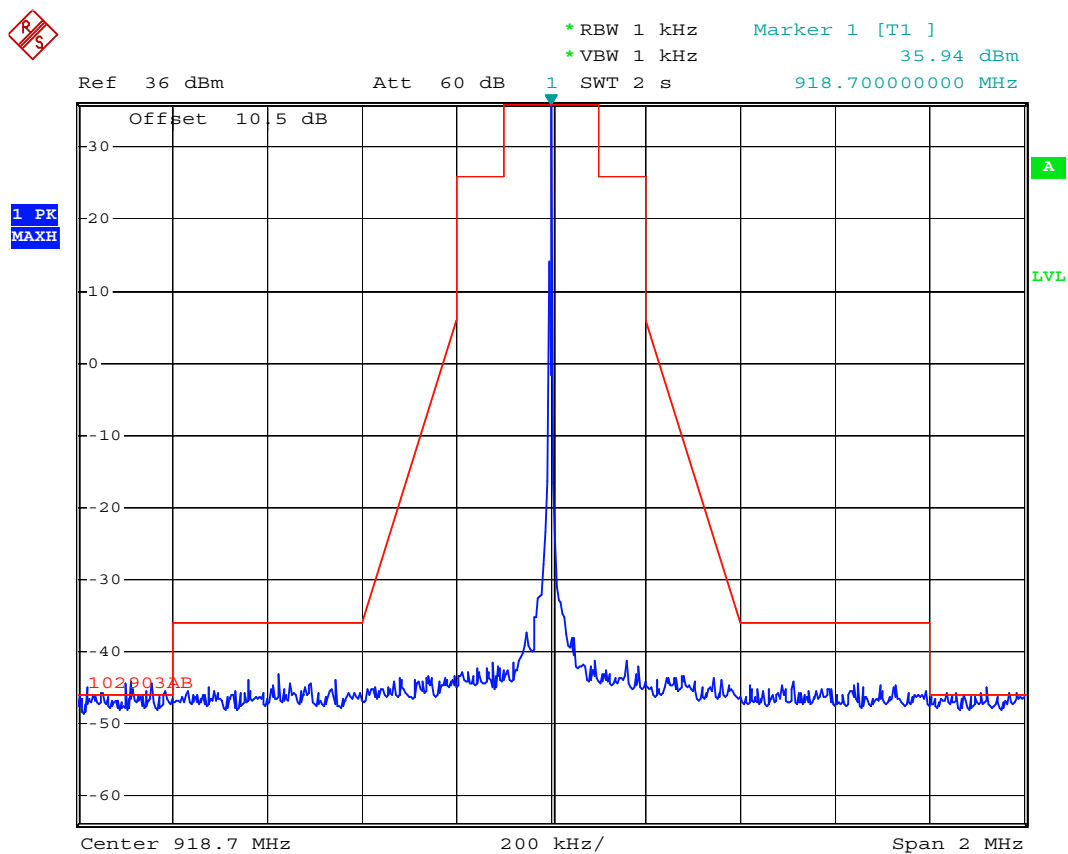

Date: 4.SEP.2012 08:29:10

Figure B.5: Calibration of the Reference Level

Measurement of the transmit spectrum mask was compared against the transmitter spectrum mask and the unwanted emissions in the spurious domain.

Figure B.6 shows the transmitter spectrum mask.

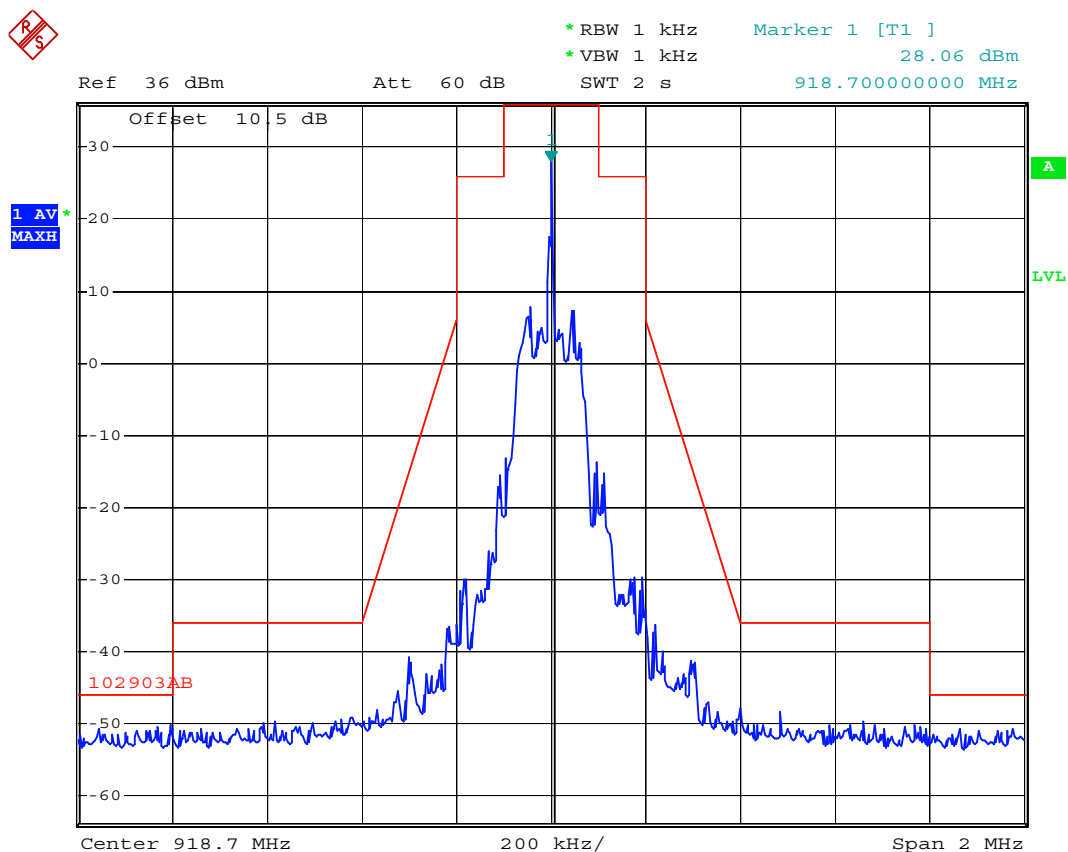

Date: 4.SEP.2012 08:28:02

Figure B.6: Transmitter spectrum

Figure B.6 shows that the Demonstrator meets the transmitter spectrum mask when generating a modulated signal.

Due to the fact that the spectrum analyser has only a limited dynamic range, it is not possible to see the real level of the signal from the Demonstrators outside the transmit channel. Figure 11 shows a level of approximately -53 dBm at a distance of ± 1 MHz from the transmit frequency. These noise levels were generated by the spectrum analyser. To see the real level of signal from the Demonstrator, an additional notch filter had to be included into the measurement setup as shown in Figure B.7.

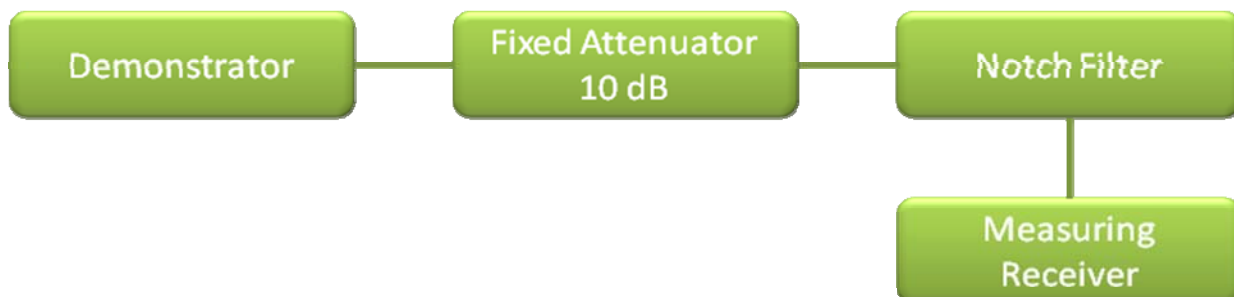

Figure B.7: Test Setup with Notch Filter for Measurement of the Transmitter Spectrum Mask

Figure B.8 and Figure B.9 show the filtering capabilities of the notch filter.

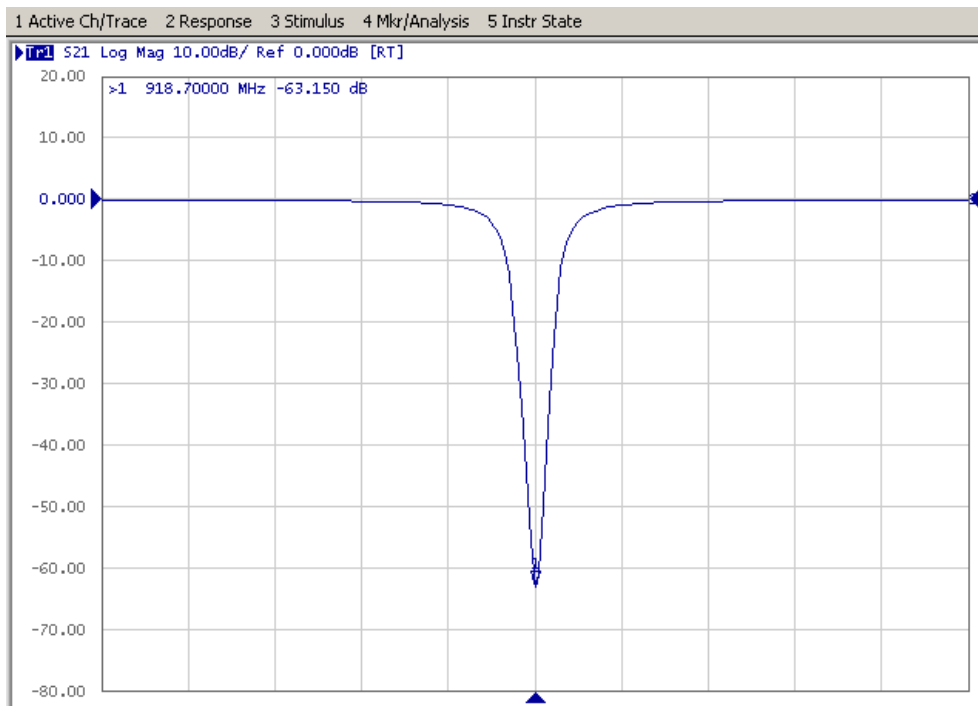

Figure B.8: S21 of the Notch Filter measured with a Network Analyser, Span 10 MHz

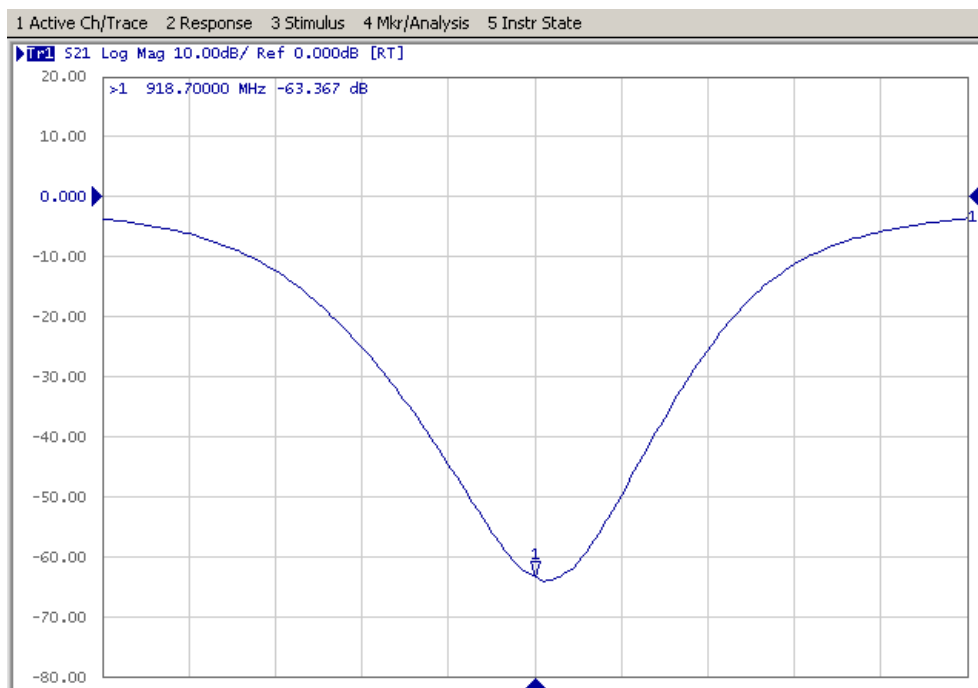
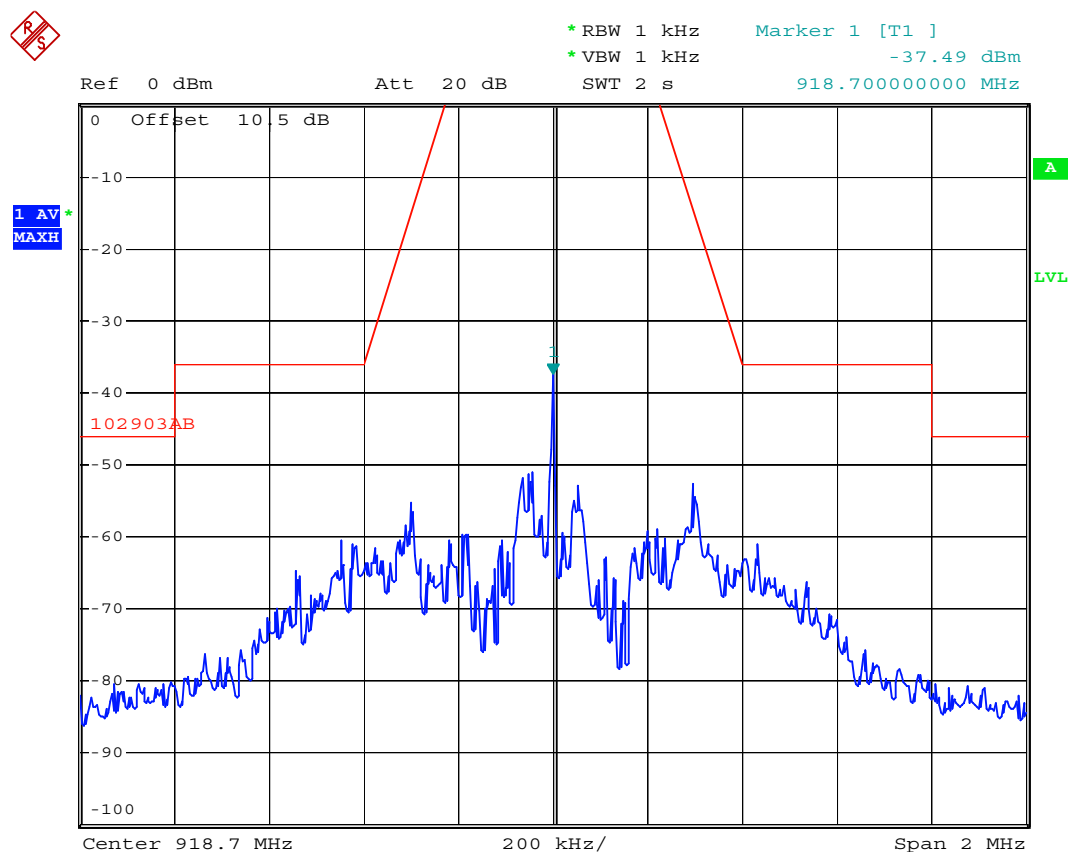

Figure B.9: S21 of the Notch Filter measured with a Network Analyser, Span 1 MHz

The filter attenuated the carrier of the demonstrator by approximately 60 dB. Due to its characteristics the influence of the notch filter can be seen across a range of approximately ± 400 kHz around centre frequency of the filter.

Figure B.10 shows the spectrum of the demonstrator with the additional notch filter included into the test setup.



Date: 4.SEP.2012 09:37:57

Figure B.10: Demonstrator Spectrum with additional Notch Filter

Figure B.10 shows that the real spurious emissions of the Demonstrator at a separation of ± 1 MHz around the carrier is much less than in the measurement without the additional filter. The spurious emissions of the Demonstrator are below -80 dBm. Therewith the Demonstrator signalling is much below the transmitter spectrum mask.

Figure B.11 shows the original measured spurious emissions levels (blue curve) and the measured "real" spurious emissions levels with the notch filter included. The additional added red curve shows the estimated shape of the spectrum generated by the demonstrator in the range ± 400 kHz around the carrier.

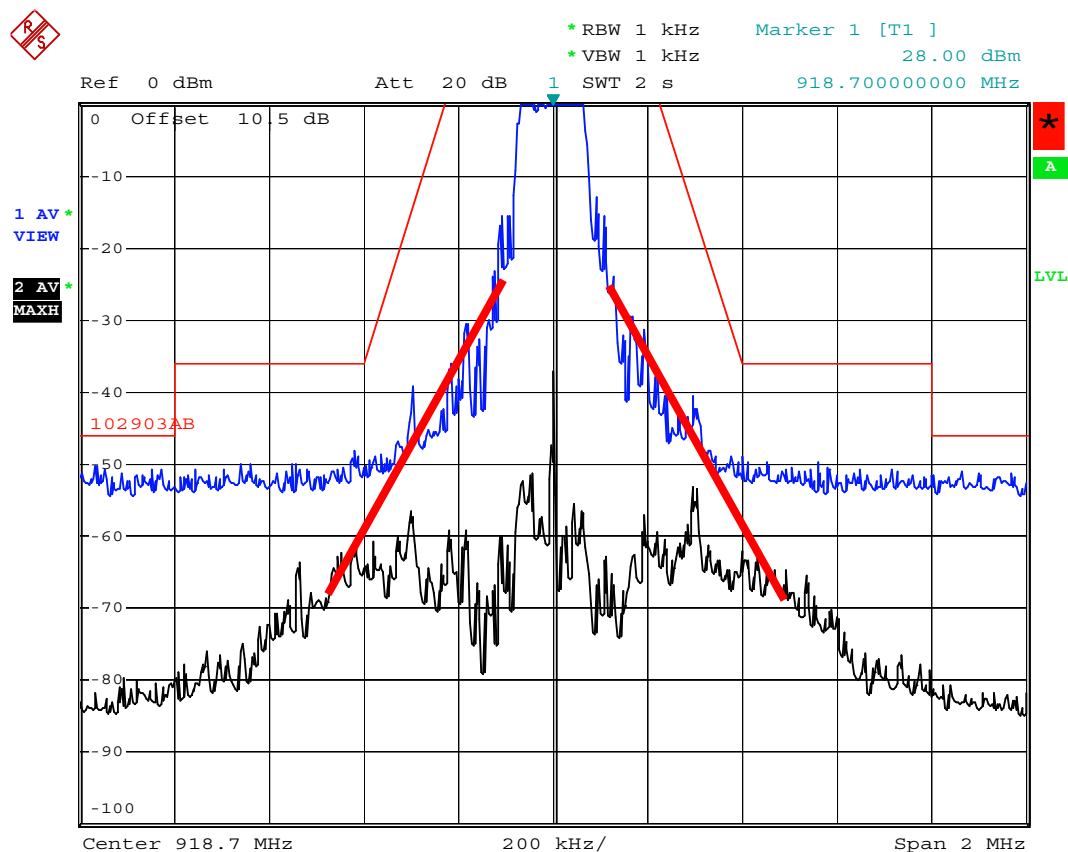

Date: 4.SEP.2012 09:36:50

Figure B.11: Combined demonstrator spectrum measured without (blue) and without (black) additional Notch Filter

B.3.2 Tag spectrum mask

The tag spectrum mask has been measured according EN 302 208-1 [1], clause 10 and SRDoc TR 102 649-2 [i.5]. The test setup was aligned as shown in Figure B.12.

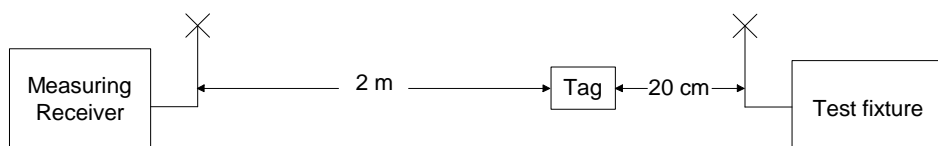

Figure B.12: Measurement of Tag emissions

Tests were performed with a tag that provided a custom specific "Calibrate" command. This was used to set the tag into a mode where it continuously transmitted the content of its user memory. After activation of the tag the interrogator transmitted a continuous wave signal at a frequency of 918,7 MHz. The tag's response was located at a frequency of $f_c - 640$ kHz and $f_c + 640$ kHz. Both sidebands were considered during the measurement. The measurement antenna had a gain of 5,4 dBi @ 918,7 MHz. The antenna cable had an attenuation of 4,6 dB @ 918,7 MHz. To calculate the correct power level, the measured signals had to be reduced by 0,8 dB. The measured free air attenuation between the position of the tag and the measuring receiver is 35,25 dB, which also needed to be taken into account.

Figures B.13 and B.14 show the results for the upper sideband.

The analyser was configured in way to give the channel power within the frequency band f_c+200 kHz to f_c+800 kHz. The channel power was recorded for both with a tag in the field and with no tag present.

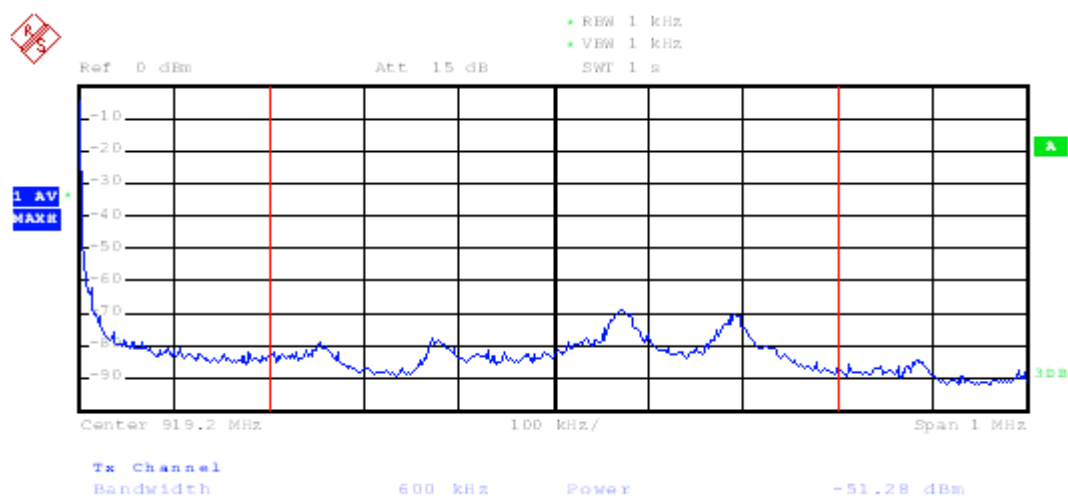

Figure B.13: Channel Power of the upper sideband with tag in the antenna field

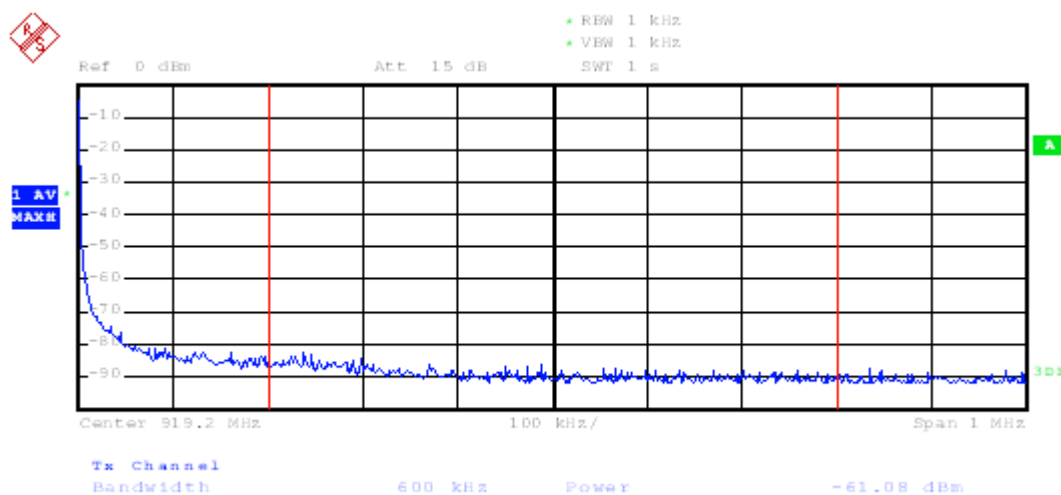

Figure B.14: Channel power of the upper sideband without tag in the antenna field

With a tag in the antenna field a channel power of -51,28 dBm was measured. Without the tag in the antenna field a channel power of just -61,08 dBm was measured.

Both measurements are required to calculate the power level of the tag response. The channel power measured with no tag present must be subtracted from the measurement with a tag in reader field. In this way the influence of the interrogator was eliminated.

$$P_c = 10 * \log\left(10^{\frac{-51,28}{10}} - 10^{\frac{-61,08}{10}}\right) - 0,8 \text{ dB} + 35,25 \text{ dB}$$

$$P_c = -51,76 \text{ dBm} - 0,8 \text{ dB} + 35,25 \text{ dB}$$

$$P_c = -17,31 \text{ dBm}$$

The same measurement was performed for the lower sideband. The results are shown below. The analyser was configured in a way to give the channel power for the frequency band fc-800 kHz to fc-200 kHz. The channel power was recorded for the setup with tag into the field and without a tag into the field.

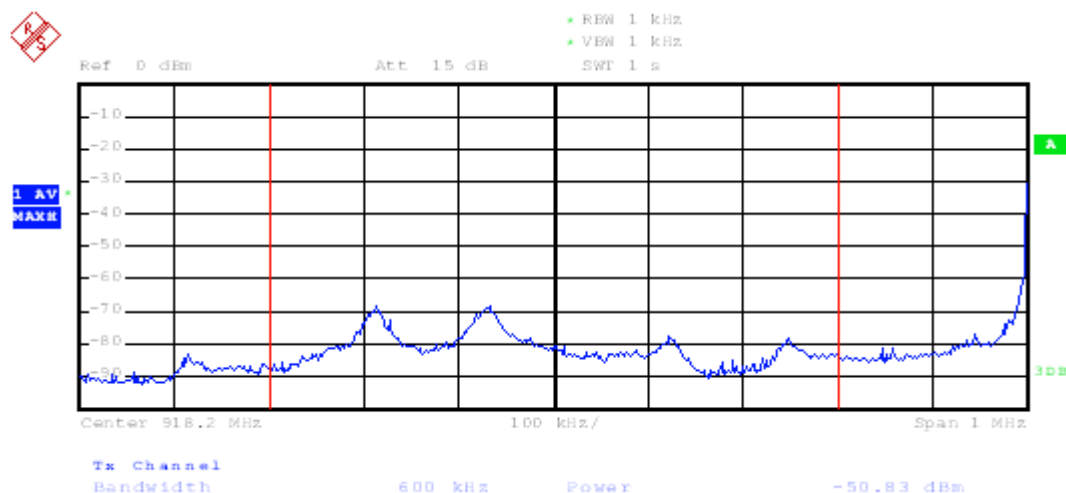

Figure B.15: Channel power of the lower sideband with tag in the antenna field

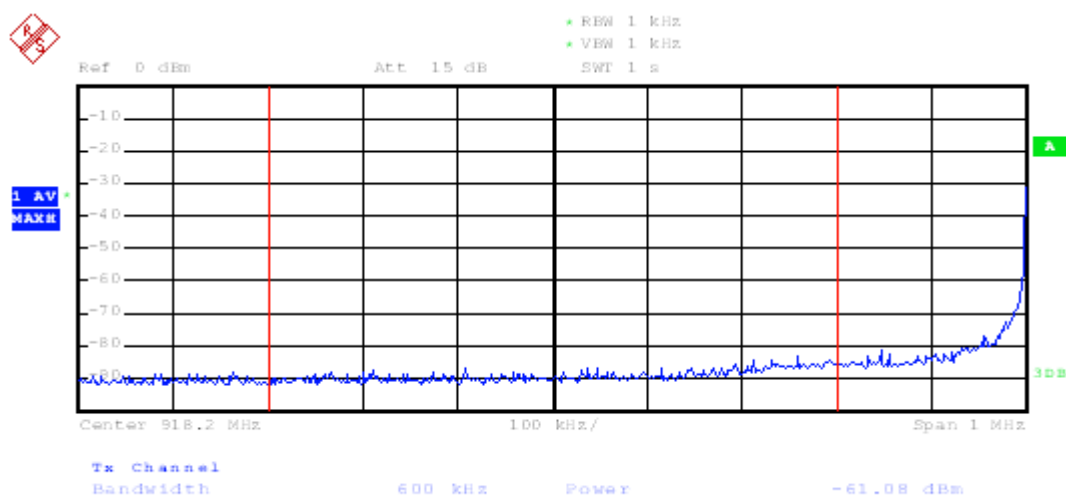

Figure B.16: Channel Power of the lower sideband without tag in the antenna field

With tag in the antenna field a channel power of -50,83 dBm was measured. Without the tag in the antenna field a channel power of just -61,08 dBm was measured.

Both measurements are required to calculate the power level of the tag response. The channel power measured in the sequence without tag in reader field needs to be subtracted from the measurement with tag. In this way the influence of the interrogator can be eliminated.

$$P_c = 10 * \log\left(10^{\frac{-50,83}{10}} - 10^{\frac{-61,08}{10}}\right) - 0,8 \text{ dB} + 35,25 \text{ dB}$$

$$P_c = -51,26 \text{ dBm} - 0,8 \text{ dB} + 35,25 \text{ dB}$$

$$P_c = -16,81 \text{ dBm}$$

According to EN 302 208-1 [1], the sideband with the higher power level should be considered as the tags response.

The result needs to be set in relation to a 100 kHz channel bandwidth using the following formula.

$$A = P_c + 10 \log \frac{100 \text{ kHz}}{BW_{\text{necessary}}}$$

Where:

P_c is the radiated power of the unmodulated sub-carrier from the tag;

A is the absolute value of the power spectrum density referred to a 100 kHz reference bandwidth;

$BW_{\text{necessary}}$ is 600 kHz, which is the necessary bandwidth of the tag.

$$A = -16,81 + 10 \log \frac{100 \text{ kHz}}{600 \text{ kHz}}$$

$$A = -24,59 \text{ dBm} / 100 \text{ kHz}$$

This value is below the defined threshold of -18 dBm / 100 kHz e.r.p.

B.4 (E)R-GSM mitigation tests

B.4.1 (E)R-GSM detection and decoding

To show the Demonstrators capability to detect a BCCH channel the Demonstrator was configured to scan the AFRCN Channel 975 to 999. These channels belong to the German mobile provider E-Plus. The E-Plus frequencies were scanned because there are no R-GSM BCCHs available in Weilburg (Germany) where the pre-test was performed. The analysis tool of the demonstrator shows carriers with BCCH channels with different power levels within the dedicated E-Plus frequency band as in Figure B.17.

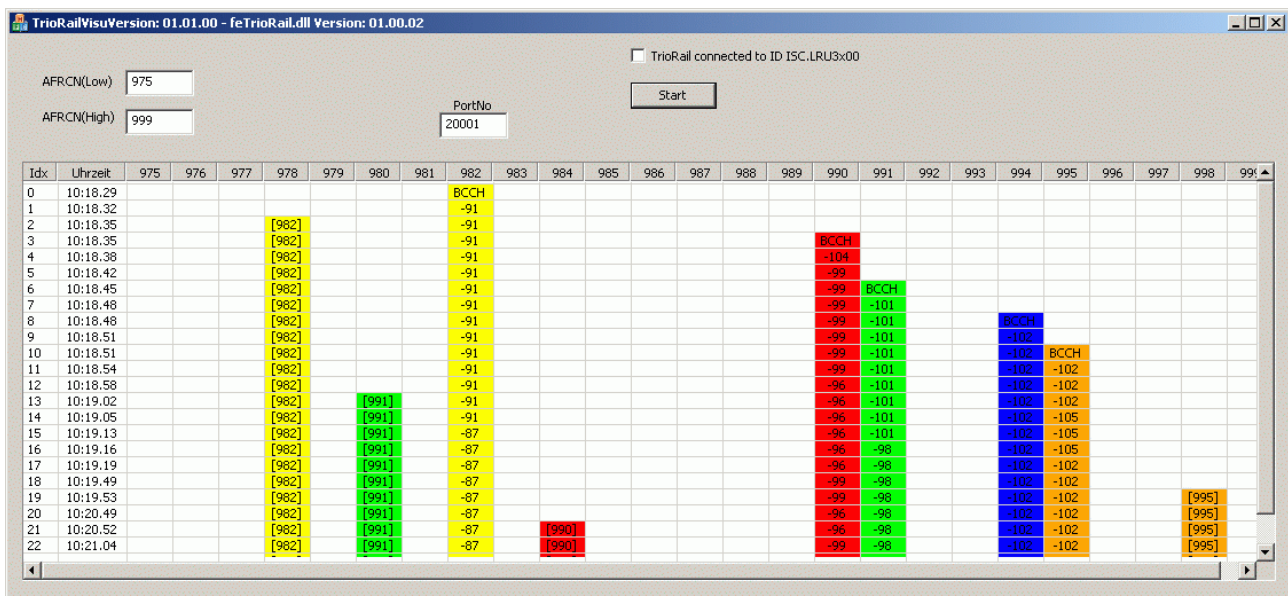

Figure B.17: Detected BCCH channels

There are 5 different carriers with BCCH channels each marked with different colours. Figure B.17 also shows the presence of four corresponding carriers with only TCH channels. A pair of a carrier with BCCH and its corresponding carrier with only TCH channel is highlighted in the same colour. Further the carrier with only TCH shows the number of the AFRCN from the carrier with the BCCH to which it belongs. The displayed channel power was controlled by means of a spectrum analyser.

Figure B.17 also shows that the carrier with BCCH could be detected at various different power levels, which were -87 dBm, -91 dBm, -96 dBm, -99 dBm, -102 dBm and -105 dBm. It should be noted that lower values were used compared to the original plan, since the threshold for detection was lowered to -98 dBm subsequent to publication of the previous version of the present document.

For AFRCN 982 the spectrum analyser showed results when measuring the channel power as in Figure B.18.

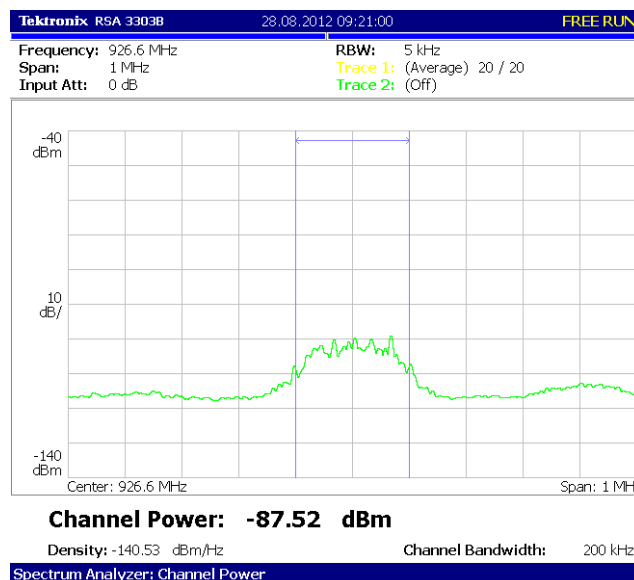

Figure B.18: Channel power of AFRCN 982 measured with a Real Time Analyzer

B.4.2 Detection at start-up of interrogator

The demonstrator was configured to use 4 transmit channels located at frequencies of 925,5 MHz, 926,7 MHz, 927,9 MHz and 929,1 MHz. These channels are all located within the E-Plus frequency band. Therefore the AFRCN channels 975 - 999 needed to be scanned. This corresponds to the following for RFID transmit channels

- For transmit on RFID TX 1 (925,5 MHz) AFRCN 975 - 980 must not be allocated by the mobile phone system.
- For transmit on RFID TX 2 (926,7 MHz) AFRCN 981 - 986 must not be allocated by the mobile phone system.
- For transmit on RFID TX 3 (927,9 MHz) AFRCN 987 - 992 must not be allocated by the mobile phone system.
- For transmit on RFID TX 4 (929,1 MHz) AFRCN 993 - 998 must not be allocated by the mobile phone system.

The test setup was done as shown in Figure B.19.



Figure B.19: Test Setup for detection during start up

Figure B.20 shows the results as measured by the demonstrator.

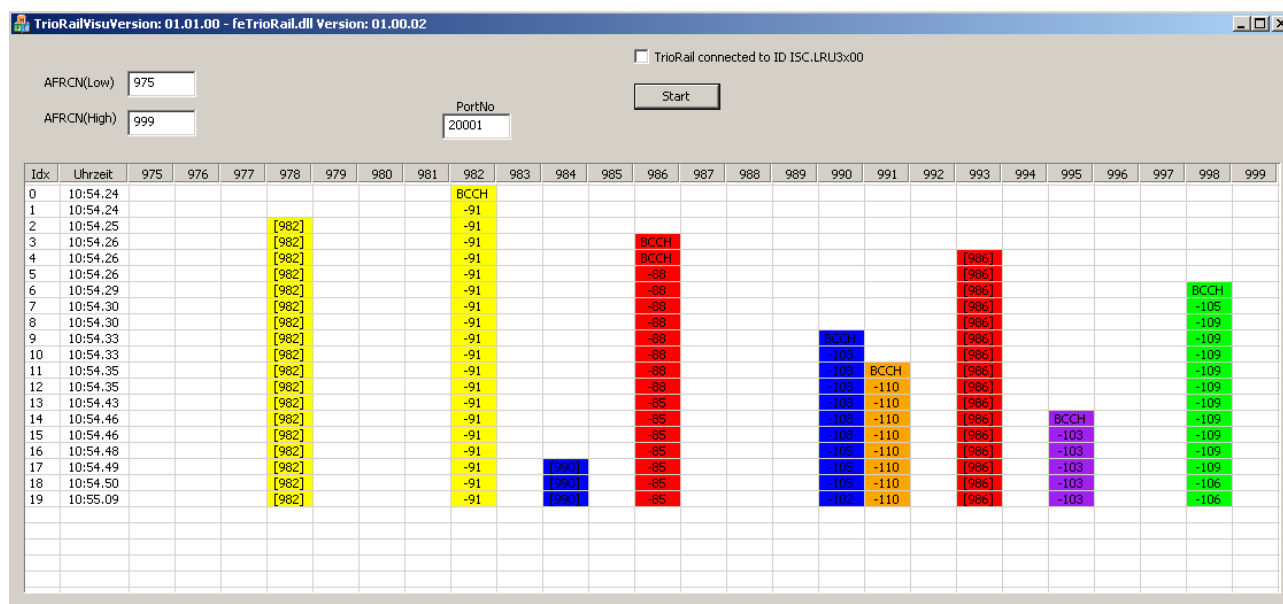

Figure B.20: AFRCN scan during start up

In the range of AFRCN 975 - 980 a TCH signal was detected. Due to this fact the RFID transmit channel 1 at 925,5 MHz could not be used.

In the range of AFRCN 981 - 986 two BCCH channels were detected. Both of them were above the defined threshold level. Due to this fact RFID transmit channel 2 at 926,7 MHz could not be used by the Demonstrator.

In the range of AFRCN 987 - 992 two BCCH signals at AFRCN 990 and AFRCN 991 were detected. The channel power of both BCCHs was below the defined threshold level of -98 dBm. Therefore RFID transmit channel 3 can be used for transmission.

In the range of AFRCN 993 - 998 two BCCH signals at AFRCN 995 and AFRCN 998 were detected. The channel power of both BCCHs is below the defined threshold level of -98 dBm. However, due to the fact that also a TCH was also detected at AFRCN 993 the channel could not be used by the demonstrator.

The following protocol was logged with the terminal tool Terra Term and which showed the ongoing operations in the demonstrator during start up. After the demonstrator has booted the RF field was off. The demonstrator then started to scan the assigned AFRCNs. The time for the initial scan can be configured in the demonstrator. In this case it was set to 50 seconds. This is enough time to scan all channels for the presence of BCCH and TCH signals. At the end of the scan procedure the Demonstrator determined that channel 3 was free. All other channels were blocked.

```

UHF-Reader FEDM_ISC_TYPE_ISCLRU3x00 detected
RFID_Freq_Offset (200kHz steps)= 46
RFID_AvailableChannels = 1234
RFID_UsedChannelNo = 00
TrioRailVisu should be running on 192.168.3.168:20001
feTrioRail-Threshold = 0
feTrioRail-Valid-Time = 50
feTrioRail-AFRCN(Low) = 975
feTrioRail-AFRCN(High) = 999
feTrioRail-EnableDbgMsg = 0
TrioRail-StartUp Collect Time = 50 seconds
Collecting data - 50 seconds left
Scan from AFRCN 975 to 999
TRIO-RAIL started...
Collecting data - 49 seconds left
...
Collecting data - 3 seconds left
Collecting data - 2 seconds left
Collecting data - 1 seconds left

```

```

Timestamp: 10:55.13
-----
Channel [1]
-----
Channel 1: RFID Frequency(in MHz) 925.500
Channel 1: Low_LimitAFRCN = 975 - High_LimitAFRCN = 980
Channel 1: AFRCN 978 [TCH] detected. Channel not available
-----
Channel [2]
-----
Channel 2: RFID Frequency(in MHz) 926.700
Channel 2: Low_LimitAFRCN = 981 - High_LimitAFRCN = 986
Channel 2: AFRCN 982 [BCCH] detected. Channel not available
Channel 2: AFRCN 986 [BCCH] detected. Channel not available
-----
Channel [3]
-----
Channel 3: RFID Frequency(in MHz) 927.900
Channel 3: Low_LimitAFRCN = 987 - High_LimitAFRCN = 992
Channel [3]: No AFRCN detected. Channel can be used
-----
Channel [4]
-----
Channel 4: RFID Frequency(in MHz) 929.100
Channel 4: Low_LimitAFRCN = 993 - High_LimitAFRCN = 998
Channel 4: AFRCN 993 [TCH] detected. Channel not available
-----

#####
Enable channel 3

```

Figure B.20 also shows that the detection of the carriers with BCCH or TCH only were completed within the required 60 seconds.

B.4.3 Detection at start-up of (E)R-GSM BTS

For this test the demonstrator was configured in a way that 4 transmit channels could be used. These were the channels at frequencies of 925,5 MHz, 926,7 MHz, 927,9 MHz and 929,1 MHz.

- For transmit on RFID TX 1 (925,5 MHz) AFRCN 975 - 980 must not be allocated by the mobile phone system.
- For transmit on RFID TX 2 (926,7 MHz) AFRCN 981 - 986 must not be allocated by the mobile phone system.
- For transmit on RFID TX 3 (927,9 MHz) AFRCN 987 - 992 must not be allocated by the mobile phone system.
- For transmit on RFID TX 4 (929,1 MHz) AFRCN 993 - 998 must not be allocated by the mobile phone system.

The test setup according to Figure B.21 was used:



Figure B.21: Test setup for detection of new BCCH during operation

The demonstrator was connected to a transmit antenna. The GSM-R Modem was connected to the USB Host Interface of the demonstrator. A variable attenuator was inserted between the GSM-R Modem and its antenna. By means of the variable attenuator the detected channel power from the different AFRCNs could be varied. A threshold was configured in the demonstrator so that only BCCHs with a level above -99 dBm would be displayed by the visualization software.

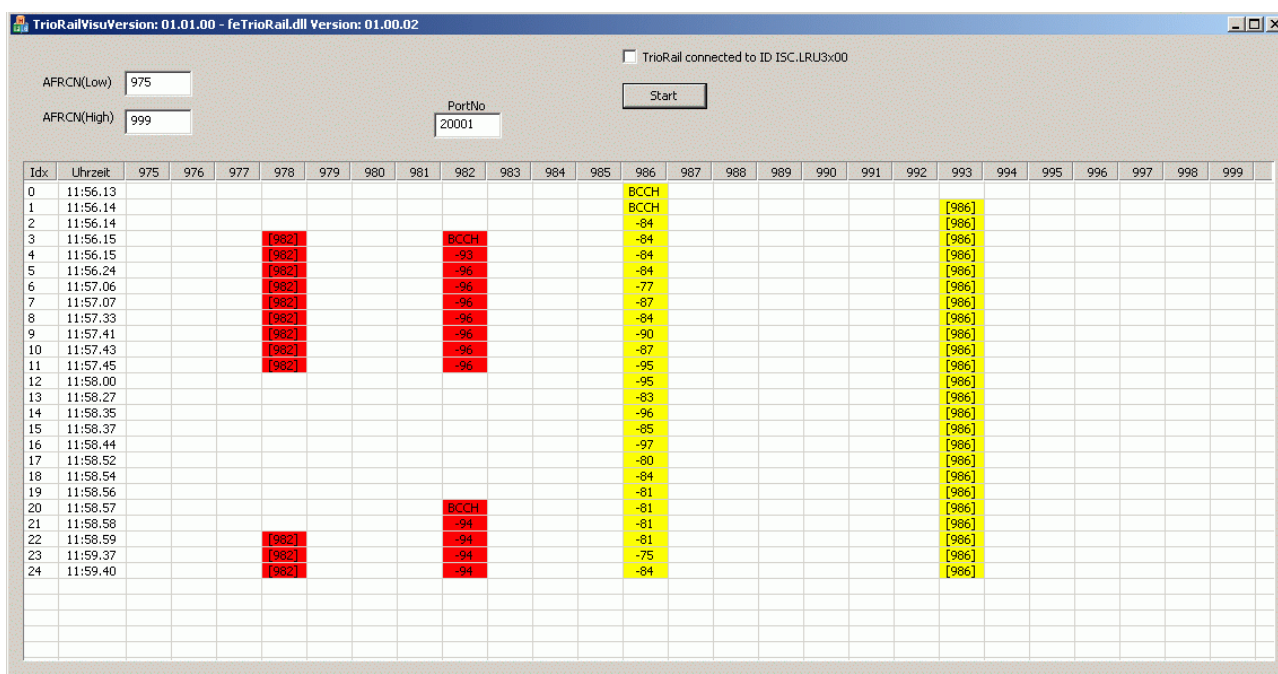

Figure B.22: AFRCN scan during demonstrator operation

The Screenshot in Figure B.22 shows a BCCH on AFRCN 982 and AFRCN 986. With the attenuator tuned to 0 dB a channel power of approximately -96 dBm is measured for AFRCN 982. For AFRCN 986 a channel power of approximately -84 dBm can be detected. Adjusting the variable attenuator to the GSM-R modem to 10 dB made the signal from the BCCH at AFRCN 982 disappear from the screen. This was because the measured channel power was below the defined threshold of -99 dBm. The BCCH at AFRCN 986 was still present. When the attenuation was removed the missing AFRCN 982 reappeared. That meant that with no attenuation transmit channel 1 and transmit channel 2 of the demonstrator were both blocked by the BCCH. When the attenuator was added to the system, channel 1 became available and only channel two remained blocked. When the attenuator was removed the channel power of the BCCH at AFRCN 982 rose above the defined threshold which indicated that channel 1 was occupied again. This can also be seen in the protocol log below.

Timestamp: 11:57.37

Channel [1]

Channel 1: RFID Frequency(in MHz) 925.500

Channel 1: Low_LimitAFRCN = 975 - High_LimitAFRCN = 980

```
Channel 1: AFRCN 978 [TCH] detected. Channel not available
-----
Channel [2]
-----
Channel 2: RFID Frequency(in MHz) 926.700
Channel 2: Low_LimitAFRCN = 981 - High_LimitAFRCN = 986
Channel 2: AFRCN 982 [BCCH] detected. Channel not available
Channel 2: AFRCN 986 [BCCH] detected. Channel not available

Timestamp: 11:58.00
-----
Channel [1]
-----
Channel 1: RFID Frequency(in MHz) 925.500
Channel 1: Low_LimitAFRCN = 975 - High_LimitAFRCN = 980
Channel [1]: No AFRCN detected. Channel can be used
-----
Channel [2]
-----
Channel 2: RFID Frequency(in MHz) 926.700
Channel 2: Low_LimitAFRCN = 981 - High_LimitAFRCN = 986
Channel 2: AFRCN 986 [BCCH] detected. Channel not available
-----

...
Timestamp: 11:58.09
-----
Channel [1]
-----
Channel 1: RFID Frequency(in MHz) 925.500
Channel 1: Low_LimitAFRCN = 975 - High_LimitAFRCN = 980
Channel 1: AFRCN 978 [TCH] detected. Channel not available
-----
Channel [2]
-----
Channel 2: RFID Frequency(in MHz) 926.700
Channel 2: Low_LimitAFRCN = 981 - High_LimitAFRCN = 986
Channel 2: AFRCN 982 [BCCH] detected. Channel not available
Channel 2: AFRCN 986 [BCCH] detected. Channel not available
-----
```

This measurement confirmed that the demonstrator was able to detect the appearance of a BTS and identify the carrier with BCCH and TCH within 60 seconds.

Annex C (informative): Bibliography

ETSI TR 101 537: "Electromagnetic compatibility and radio spectrum matters (ERM); Second co-existence test between ER-GSM with RFID".

EIRENE Functional Requirements Specification Version 7.1.

History

Document history		
V1.1.1	July 2012	Publication
V1.2.1	February 2013	Publication