

REV.	DESCRIPTION	DATE
A	NEW DRAWING	1/3/2006
B	updated PCB layout	2/6/2008
C	added TR package option	11/29/2012

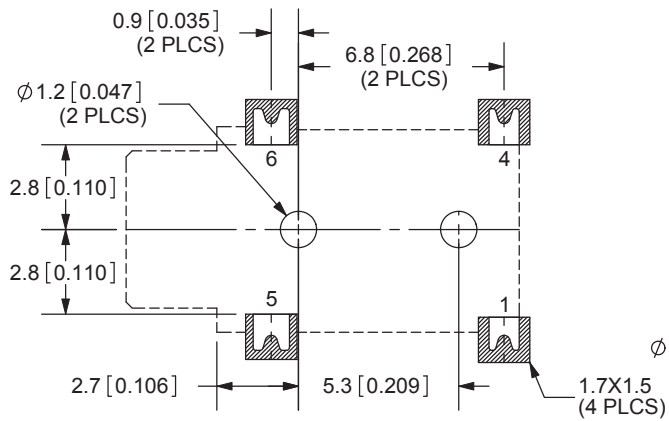

PCB LAYOUT
TOP VIEW

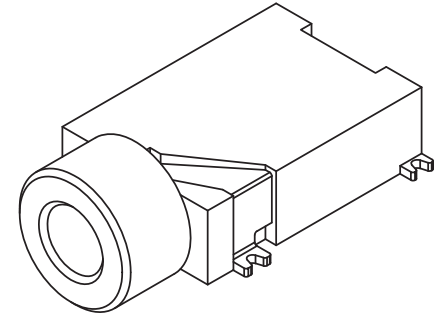
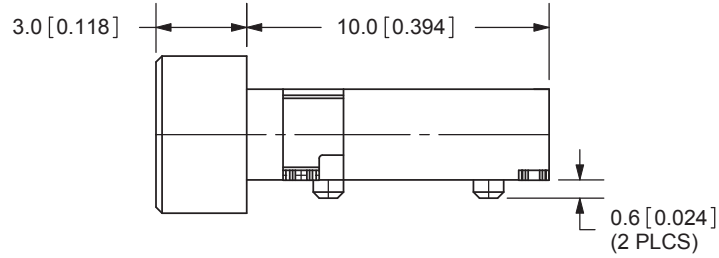
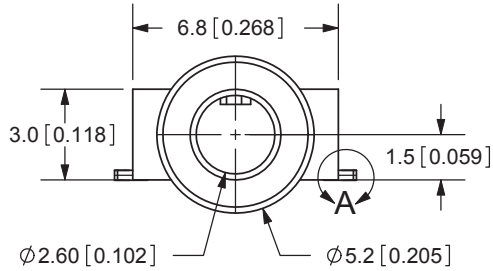
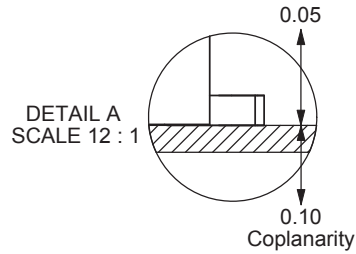
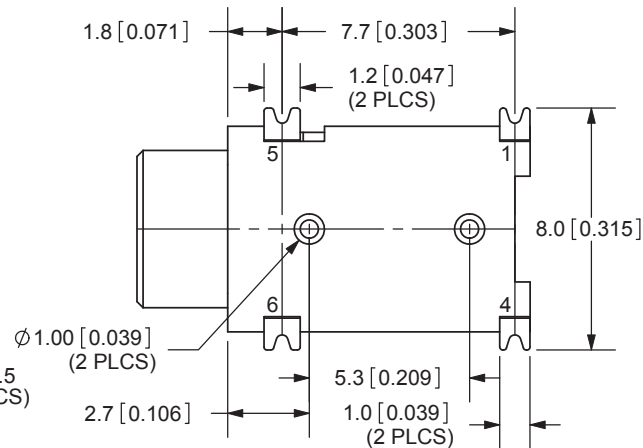

Note:
Add suffix "-TR" to the model number for
tape & reel packaging

TOLERANCE:
X.X ± 0.3 mm
X.XX ± 0.2 mm

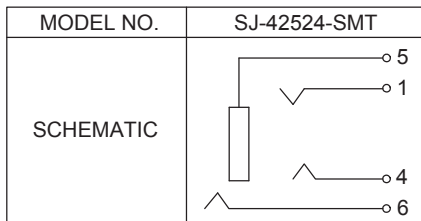

SPECIFICATIONS:
RATING: 16V DC @ 300mA
CONTACT RESISTANCE: 100m OHMS MAX
INSULATION RESISTANCE: 100M OHMS MIN: 500V DC
VOLTAGE WITHSTAND: 500V AC R.M.S. FOR 1 MINUTE
LIFE: 5,000 CYCLES
OPERATING TEMP: -40 ~ +85C

	MATERIAL	PLATING
TERMINAL 1	Titanium Copper	Silver
TERMINAL 4	Titanium Copper	Silver
TERMINAL 5	Phosphor Bronze	Silver
TERMINAL 6	Brass	Gold
HOUSING	PBT	



20050 SW 112th Ave.
Tualatin, OR 97062
Phone: 503-612-2300
800-275-4899
Fax: 503-612-2383
Website: www.cui.com

TITLE:	SMT AUDIO JACK W/4 CONDUCTORS 2.5mm	REV:	C
PART NO.	SJ-42524-SMT	UNITS:	MM [INCHES]
DRAWN BY:	ZRJ	APPROVED BY:	
		SCALE:	4:1

PC FILE NAME:
SJ-42524-SMT

COPYRIGHT 2012 BY CUI INC.

REV.	DESCRIPTION	DATE
A	NEW DRAWING	1/3/2006
B	updated PCB layout	2/6/2008
C	housing material change	2/9/2011
D	added TR package option	11/29/2012

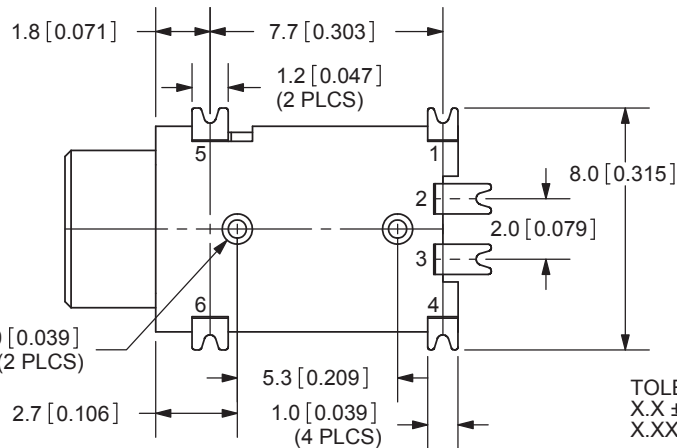
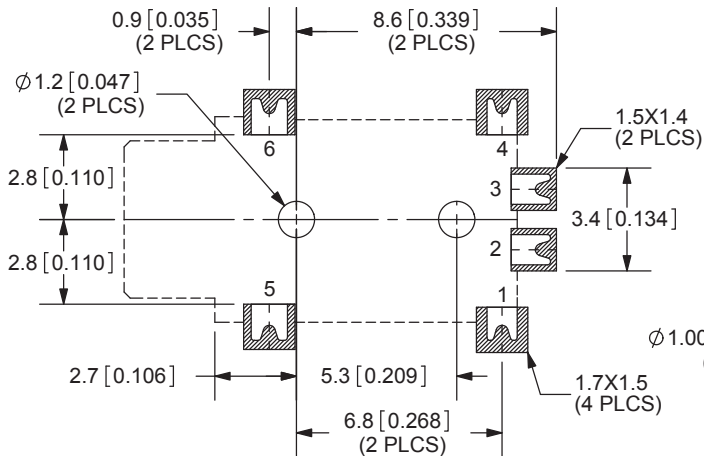
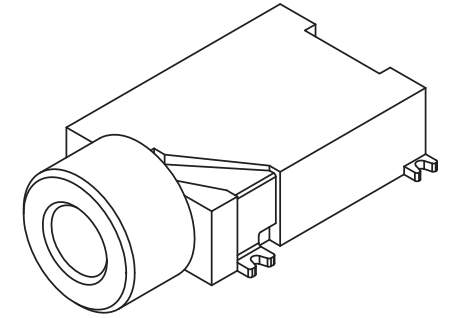
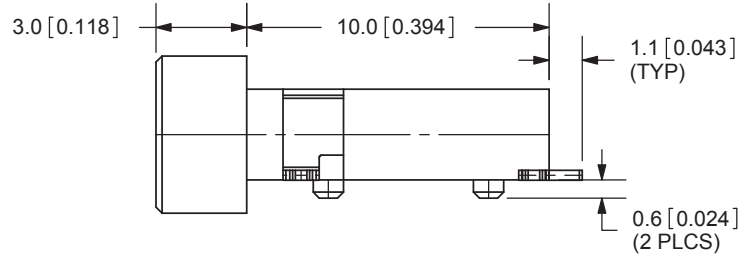
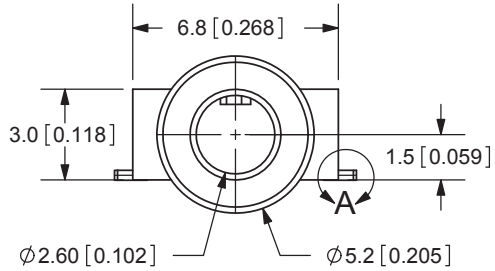
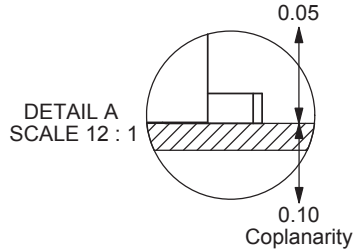

Note:
Add suffix "-TR" to the model number for
tape & reel packaging

TOLERANCE:
X.X ± 0.3 mm
X.XX ± 0.2 mm



PCB LAYOUT
TOP VIEW

SPECIFICATIONS:
RATING: 16V DC @ 300mA
CONTACT RESISTANCE: 100m OHMS MAX
INSULATION RESISTANCE: 100M OHMS MIN: 500V DC
VOLTAGE WITHSTAND: 500V AC R.M.S. FOR 1 MINUTE
LIFE: 5,000 CYCLES

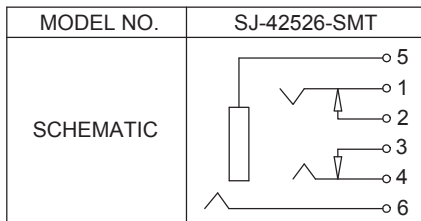

	MATERIAL	PLATING
TERMINAL 1	Titanium Copper	Silver
TERMINAL 2	Brass	Silver
TERMINAL 3	Brass	Silver
TERMINAL 4	Titanium Copper	Silver
TERMINAL 5	Phosphor Bronze	Silver
TERMINAL 6	Brass	Gold
HOUSING	LCP	



20050 SW 112th Ave.
Tualatin, OR 97062
Phone: 503-612-2300
800-275-4899
Fax: 503-612-2383
Website: www.cui.com

TITLE:	SMT AUDIO JACK W/4 CONDUCTORS 2.5mm	REV:	D
PART NO.	SJ-42526-SMT	UNITS:	MM [INCHES]
DRAWN BY:	ZRJ	APPROVED BY:	
		SCALE:	4:1

PC FILE NAME:
SJ-42526-SMT

COPYRIGHT 2012 BY CUI INC.